

This drawing is confidential and must not be reproduced or used without the consent of EXM

Ce dessin est confidentiel et ne doit pas être reproduit ou utilisé sans le consentement de EXM

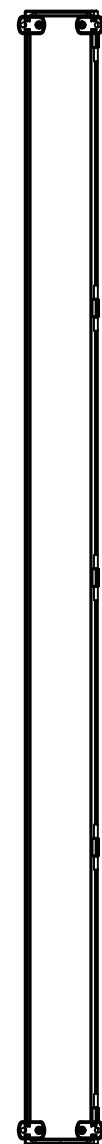

TOP



BACK



BOTTOM

0.000
4.000

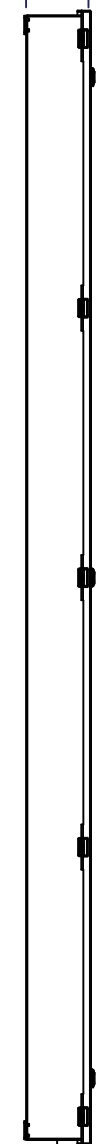

LEFT

0.000
4.000

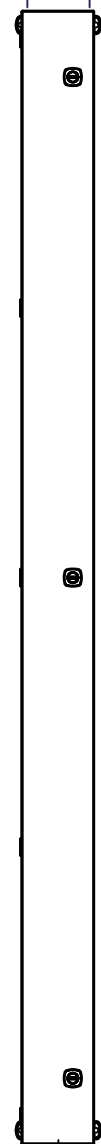

FRONT

72.000



RIGHT

0.000

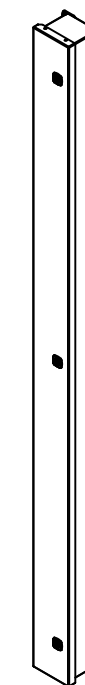

Isometric View



No.	Revisions	Date	By/Par

		Flatness Aplatissement Max 3.0mm	
Tél: (450) 979-4373 Fax: (450) 979-4626 www.exmweb.com		Projection 	
Customer Client		Date	
Drawn By Dessiné Par BoxCad: BoxCad		Date 16-Jan-14	
Material Matière 16 Ga Cold Rolled A1008 CS Type B (1.4mm)			
Color Couleur Asa-61 Grey		Finish Fini Smooth	
Description 1412CH 72" x 4" x 4" Assembly			Detail Rev.
Part Number Numéro Pièce 1412CH040472		Rev. 0	1/2

SEE BILL OF MATERIAL ON LAST PAGE

This drawing is confidential and must not be reproduced or used without the consent of EXM

Ce dessin est confidentiel et ne doit pas être reproduit ou utilisé sans le consentement de EXM

NOTE	
ITEM	DESCRIPTION
1	NEMA 4/12 Enclosure
2	C/W Standard ground standoffs on box and cover
3	W/O Standard door stiffener
4	W/O Inner panel
5	W/O Inner panel mounting standoffs

No.	Revisions	Date	By/Par

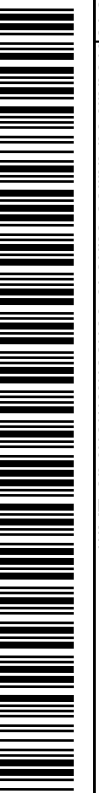
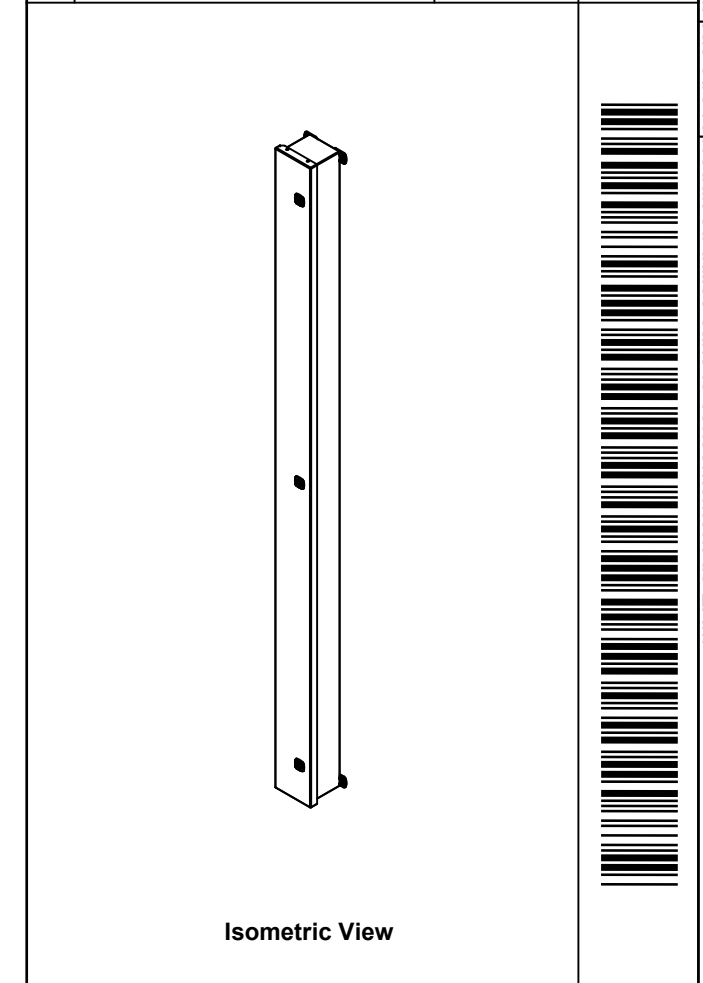

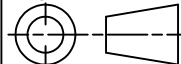
 Tél: (450) 979-4373 Fax: (450) 979-4626 www.exmweb.com	Flatness Aplatissement
	Max 3.0mm
Projection	
Customer Client	Date
Drawn By Dessiné Par	BoxCad: BoxCad
Date	16-Jan-14
Material Matière	16 Ga Cold Rolled A1008 CS Type B (1.4mm)
Color Couleur	Asa-61 Grey
Finish Fini	Smooth

PACKING		
ITEM	QTY	DESCRIPTION
Cardboard sleeve	1	Top
Thermal plastic film	1	Use with Packing Tunnel Wrapper Machine
Packaging label	1	White label with product number

Qty	Part Number	Rev	Description
1	1412CH040472C	0	1412CH 72" x 4" Cover
1	1412CH040472B	0	1412CH 72" x 4" x 4" Body
2	STK-K-02570	0	1412 CH Accessory Kit
5	STK-Q-08100	1	M5 Nylon Insert Lock Nut
Parts List			

Description	1412CH 72" x 4" x 4" Assembly	Detail Rev.	
Part Number Numéro Pièce	1412CH040472	Rev.	2
		0	2

This drawing is confidential and must not be reproduced or used without the consent of EXM

Ce dessin est confidentiel et ne doit pas être reproduit ou utilisé sans le consentement de EXM



TOP



BACK



BOTTOM

0.000
4.000

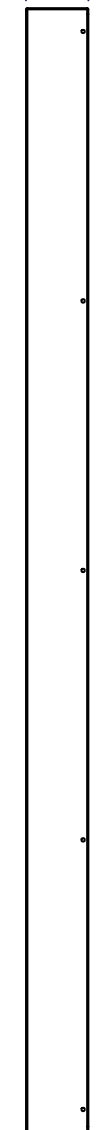

LEFT

0.000
4.000

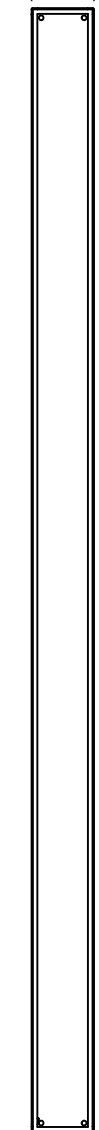

FRONT

72.000

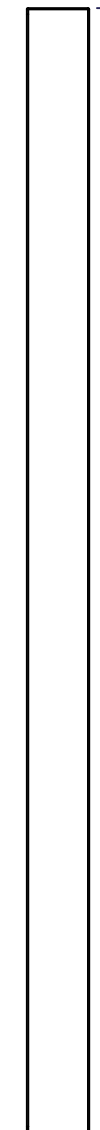

RIGHT 0.000

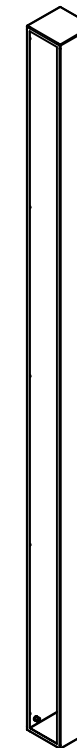

Isometric View

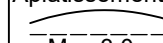
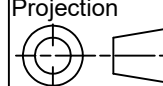

No.	Revisions	Date	By/Par

 Tél: (450) 979-4373 Fax: (450) 979-4626 www.exmweb.com		Flatness Aplatissement  Max 3.0mm Projection 
Customer Client	Date	
Drawn By Dessiné Par	BoxCad: BoxCad	Date 16-Jan-14
Material Matière	16 Ga Cold Rolled A1008 CS Type B (1.4mm)	
Color Couleur	Asa-61 Grey	Finish Fini Smooth
Description 1412CH 72" x 4" x 4" Body		Detail Rev.
Part Number Numéro Pièce	Rev. 0	1 / 7

SEE BILL OF MATERIAL ON LAST PAGE

1412CH040472B



This drawing is confidential and must not be reproduced or used without the consent of EXM

Ce dessin est confidentiel et ne doit pas être reproduit ou utilisé sans le consentement de EXM

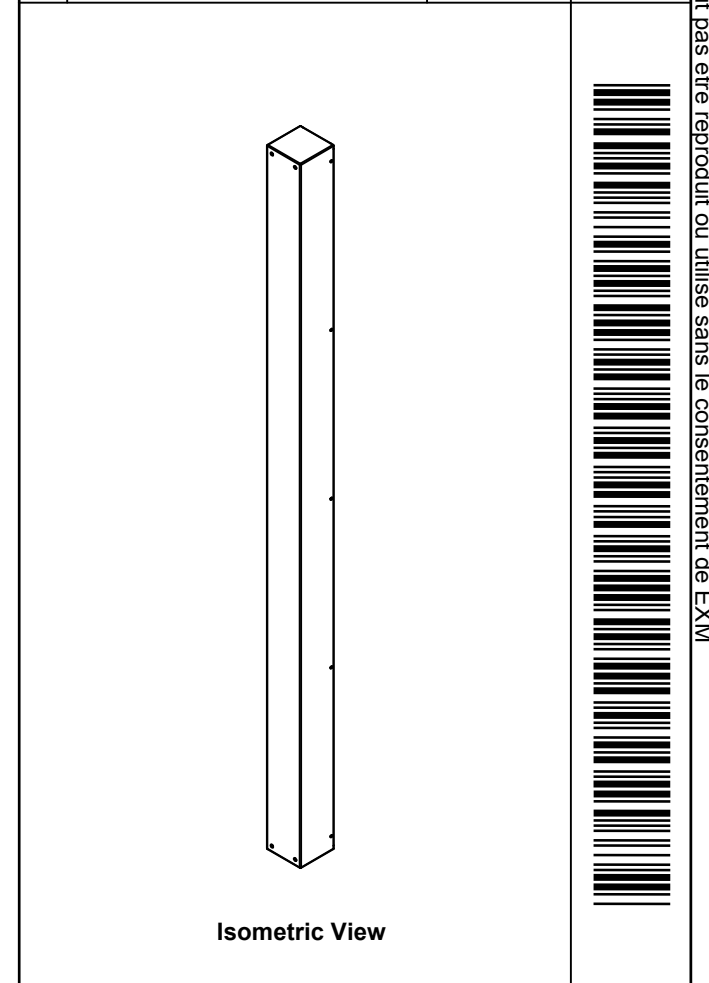
No.	Revisions	Date	By/Par

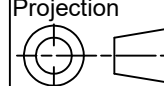

Isometric View

 Tél: (450) 979-4373 Fax: (450) 979-4626 www.exmweb.com		Flatness Aplatissement  Max 3.0mm Projection 
Customer Client	Date	
Drawn By Dessiné Par	BoxCad: BoxCad	Date 16-Jan-14
Material Matière	16 Ga Cold Rolled A1008 CS Type B (1.4mm)	
Color Couleur	Asa-61 Grey	Finish Fini Smooth
Description		Detail Rev.
1412CH 72" x 4" x 4" Body		
Part Number Numéro Pièce	Rev.	7
1412CH040472B	0	7

Qty	Part_Number	Rev	Description
1	1412CH040472B-P	0	1412CH 72" x 4" x 4" Body Part
1	STK-P-02400S	0	Powder Paint (Asa-61 Grey / Smooth)
1	STK-Q-08350	5	Standoff M6 x 10mm
Parts List			

This drawing is confidential and must not be reproduced or used without the consent of EXM

Ce dessin est confidentiel et ne doit pas être reproduit ou utilisé sans le consentement de EXM

TOP

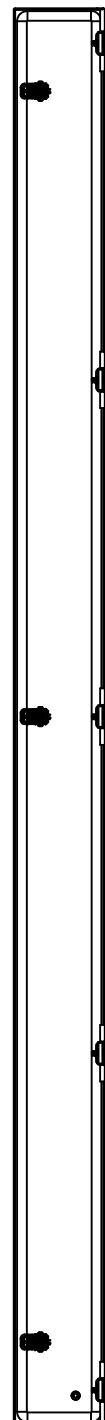

BACK

BOTTOM

0.000
0.875

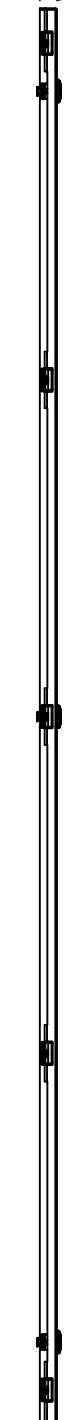

LEFT

0.000
4.687

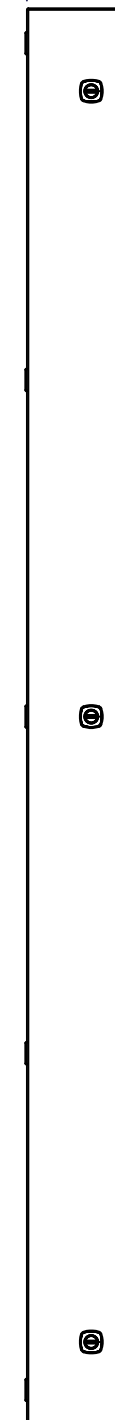

FRONT

72.592



RIGHT 0.000

No.	Revisions	Date	By/Par

Isometric View

<p>Tél: (450) 979-4373 Fax: (450) 979-4626 www.exmweb.com</p>		<p>Flatness Aplatissement Max 3.0mm</p> <p>Projection</p>
Customer Client	Date	
Drawn By Dessiné Par	BoxCad: BoxCad	Date 16-Jan-14
Material Matière	16 Ga Cold Rolled A1008 CS Type B (1.4mm)	
Color Couleur	Asa-61 Grey	Finish Fini Smooth
Description	Detail Rev.	
1412CH 72" x 4" Cover		
Part Number Numéro Pièce	Rev. 0	1 3
1412CH040472C		

SEE BILL OF MATERIAL ON LAST PAGE

This drawing is confidential and must not be reproduced or used without the consent of EXM

Ce dessin est confidentiel et ne doit pas être reproduit ou utilisé sans le consentement de EXM

STANDARD FEATURES ARE NOT LISTED IN THIS HOLE TABLE			
HOLE TABLE - FRONT VIEW (CUSTOM FEATURE ONLY)			
CUT-OUT	XDIM	YDIM	DESCRIPTION
1	3.307	68.342	LOCK 880 SCQ4CH-SL @ 180.0°
2	3.307	36.296	LOCK 880 SCQ4CH-SL @ 180.0°
3	3.307	4.250	LOCK 880 SCQ4CH-SL @ 180.0°

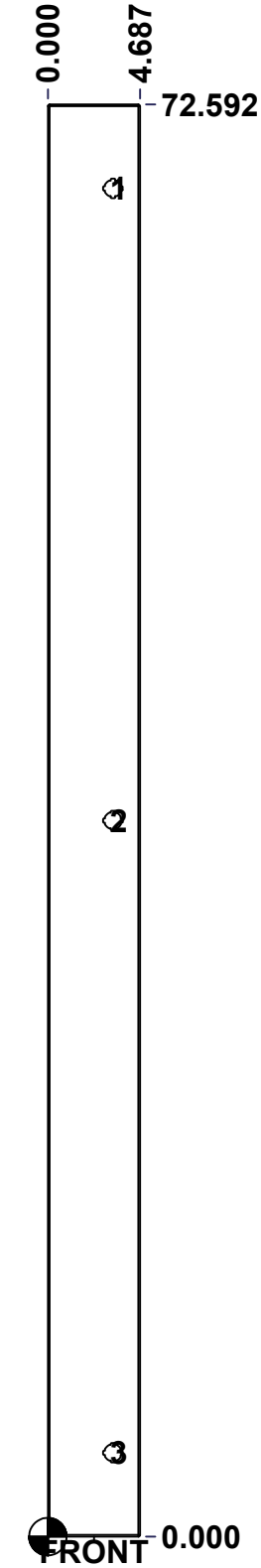



	Description	Status	
	1412CH 72" x 4" Cover	(NULL)	
	Part Number Numéro Pièce	Rev.	
	1412CH040472C	0	2 3

This drawing is confidential and must not be reproduced or used without the consent of EXM

Ce dessin est confidentiel et ne doit pas être reproduit ou utilisé sans le consentement de EXM

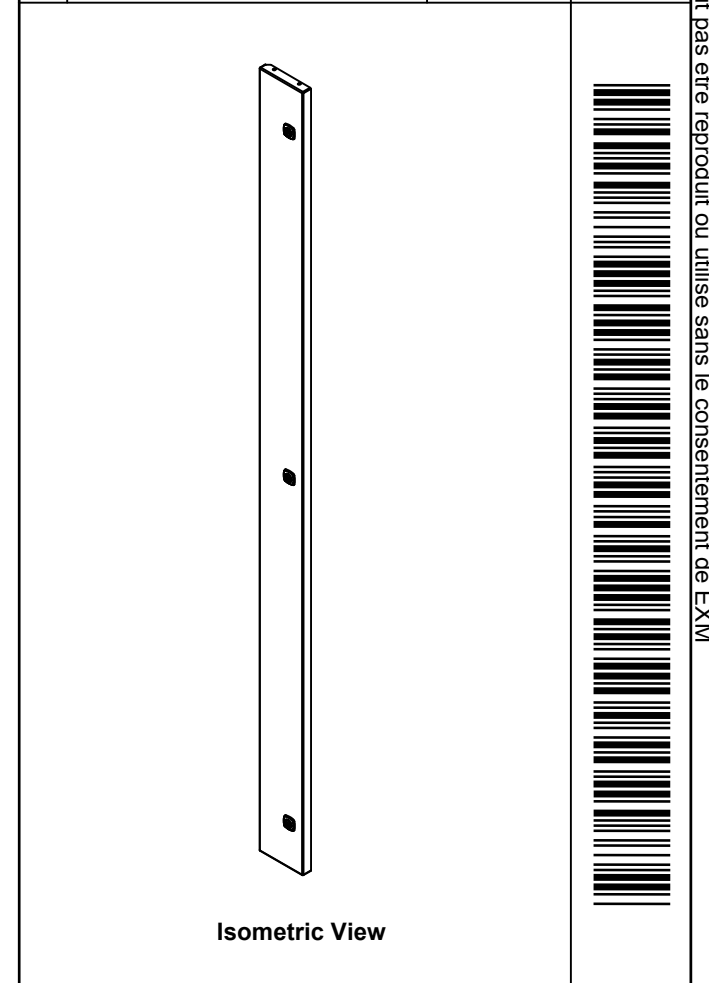
No.	Revisions	Date	By/Par

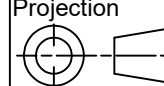

 Tél: (450) 979-4373 Fax: (450) 979-4626 www.exmweb.com		Flatness Aplatissement  Max 3.0mm Projection 
Customer Client	Date	
Drawn By Dessiné Par	BoxCad: BoxCad	Date 16-Jan-14
Material Matière 16 Ga Cold Rolled A1008 CS Type B (1.4mm)		
Color Couleur	Asa-61 Grey	Finish Fini Smooth
Description 1412CH 72" x 4" Cover		Detail Rev.
Part Number Numéro Pièce 1412CH040472C		Rev. 3 0 3

Qty	Part Number	Rev	Description
1	STK-P-02400S	0	Powder Paint (Asa-61 Grey / Smooth)
1	1412CH040472G	0	1412CH 72" x 4" Gasket
1	STK-Q-08350	5	Standoff M6 x 10mm
1	1412CH040472C-P	0	1412CH 72" x 4" Cover Part
5	STK-A-33033	4	5412 ESMCH Hinge
3	880 SCQ4CH-SL	0	5412 CH 1/4 Turn Lock
Parts List			