

This drawing is confidential and must not be reproduced or used without the consent of EXM

Ce dessin est confidentiel et ne doit pas être reproduit ou utilisé sans le consentement de EXM

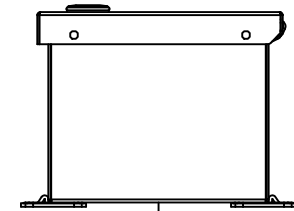

TOP

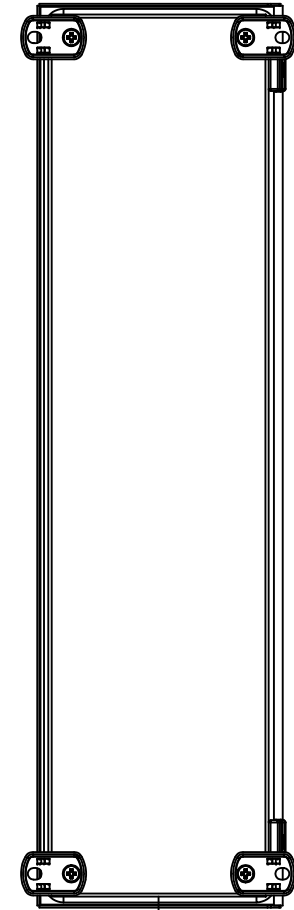

BACK

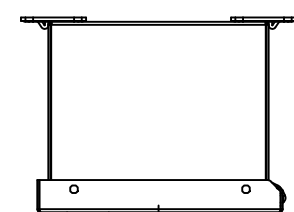

BOTTOM

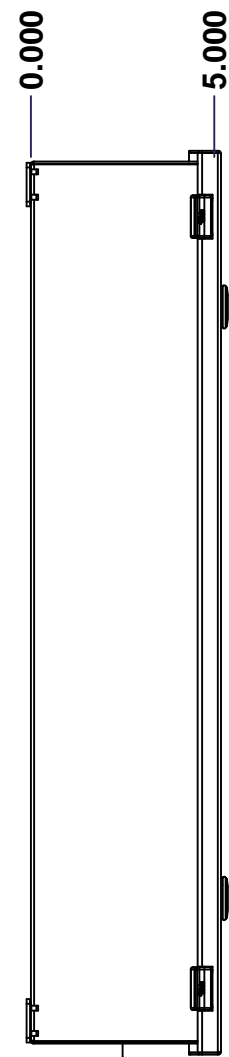

LEFT

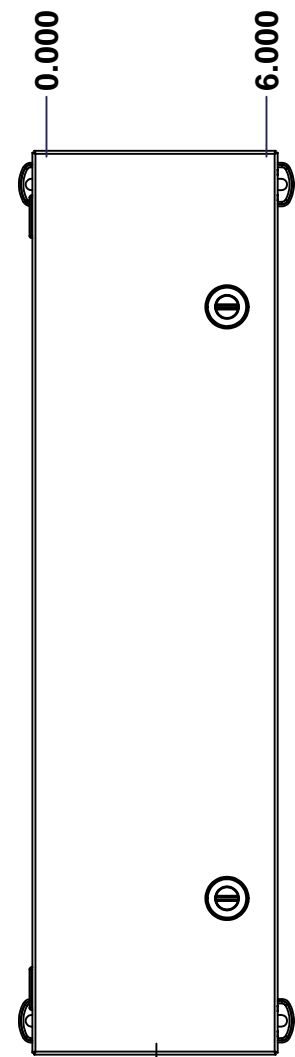

FRONT

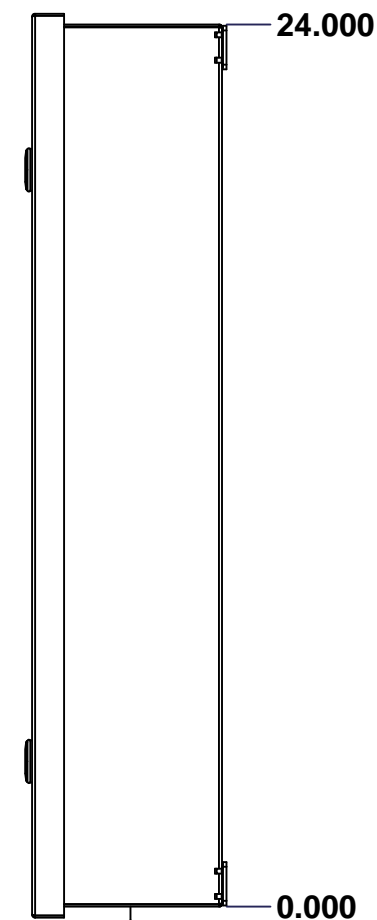

RIGHT

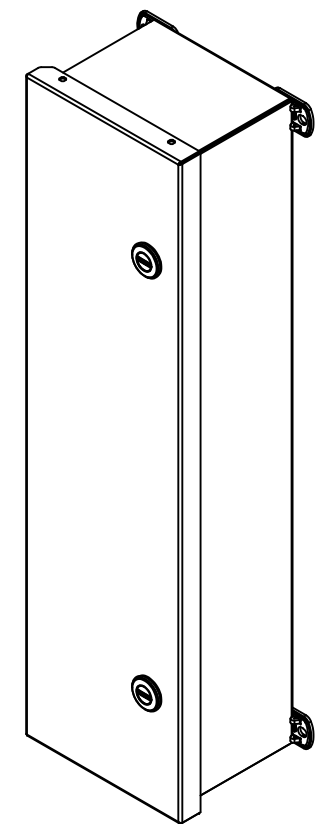

Isometric View

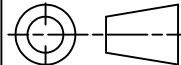

No.	Revisions	Date	By/Par

 Tél: (450) 979-4373 Fax: (450) 979-4626 www.exmweb.com		Flatness Aplatissement Max 3.0mm Projection 
Customer Client	Date	Date
Drawn By Dessiné Par	BoxCad: JasonW	Date 23/11/2014
Material Matière	16 Ga H.R.P. & O. (1.4mm)	
Color Couleur	Asa-61 Grey	Finish Fini Smooth
Description	1412CH 24" x 6" x 5" Assembly	
Part Number Numéro Pièce	1412CH060524IP	Detail Rev. Rev. 1 0 2

SEE BILL OF MATERIAL ON LAST PAGE

This drawing is confidential and must not be reproduced or used without the consent of EXM

Ce dessin est confidentiel et ne doit pas être reproduit ou utilisé sans le consentement de EXM

NOTE	
ITEM	DESCRIPTION
1	NEMA 4/12 Enclosure
2	C/W Standard ground standoffs on box and cover
3	W/O Standard door stiffener
4	C/W Special inner panel (Sold seperately)
5	C/W Standard inner panel mounting standoffs

No.	Revisions	Date	By/Par

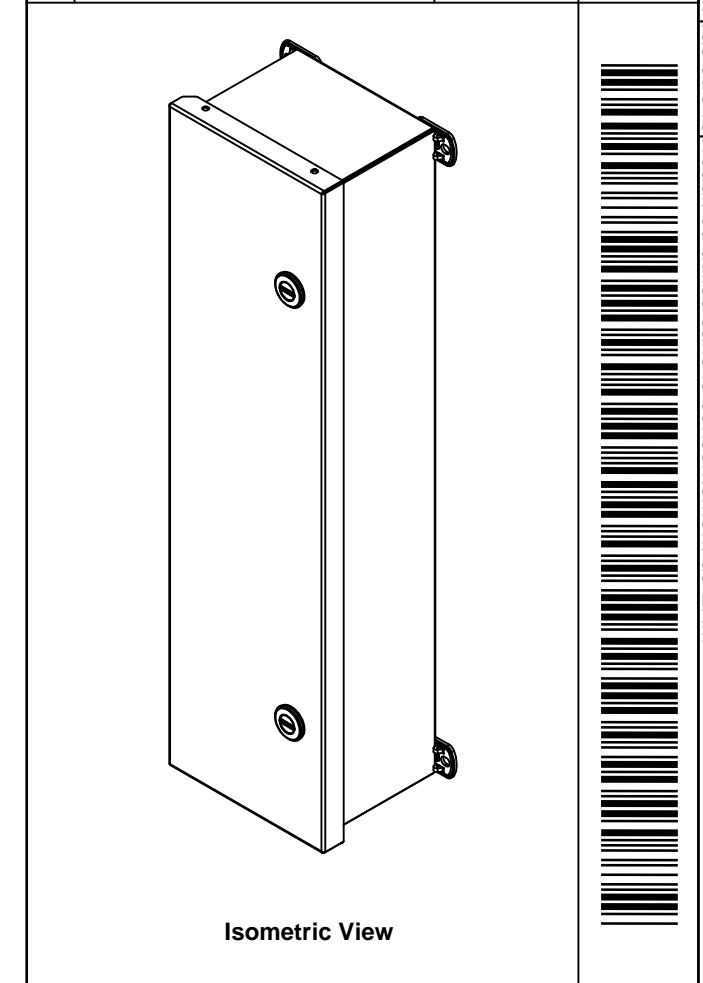

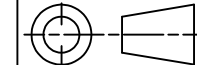
 Tél: (450) 979-4373 Fax: (450) 979-4626 www.exmweb.com		Flatness Aplatissement Max 3.0mm Projection 
Customer Client	Date	
Drawn By Dessiné Par	BoxCad: JasonW	Date 23/11/2014
Material Matière	16 Ga H.R.P. & O. (1.4mm)	
Color Couleur	Asa-61 Grey	Finish Fini Smooth
Description		Detail Rev.
1412CH 24" x 6" x 5" Assembly		
Part Number Numéro Pièce	Rev.	2
1412CH060524IP	0	2

Qty	Part Number	Rev	Description
1	1412CH060524IPC	0	1412CH 24" x 6" Cover
1	STK-K-00200	1	M6 x 8mm Hexagon/Slot Screw (Bag of 6)
1	1412CH060524IPI	0	1412CH 24" x 6" Inner Panel Part
1	1412CH060524IPB	0	1412CH 24" x 6" x 5" Body
2	STK-K-02570	0	1412 CH Accessory Kit
2	STK-Q-08100	1	M5 Nylon Insert Lock Nut
Parts List			

This drawing is confidential and must not be reproduced or used without the consent of EXM

Ce dessin est confidentiel et ne doit pas être reproduit ou utilisé sans le consentement de EXM

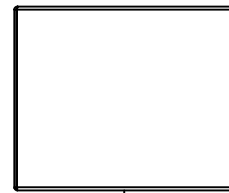

TOP

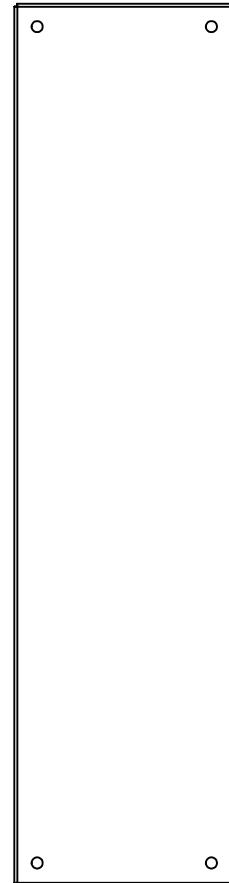

BACK

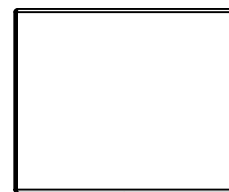

BOTTOM

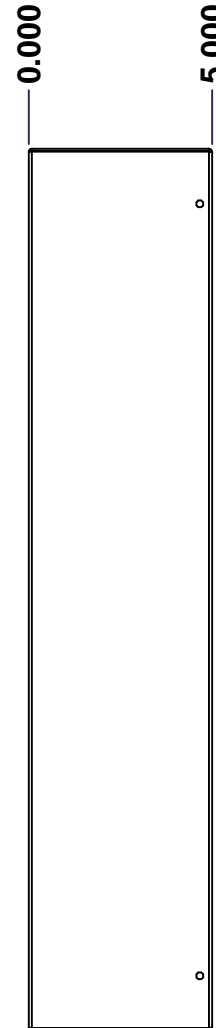

LEFT

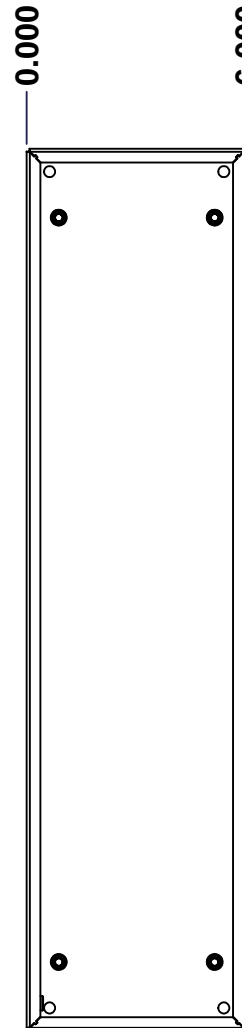

FRONT

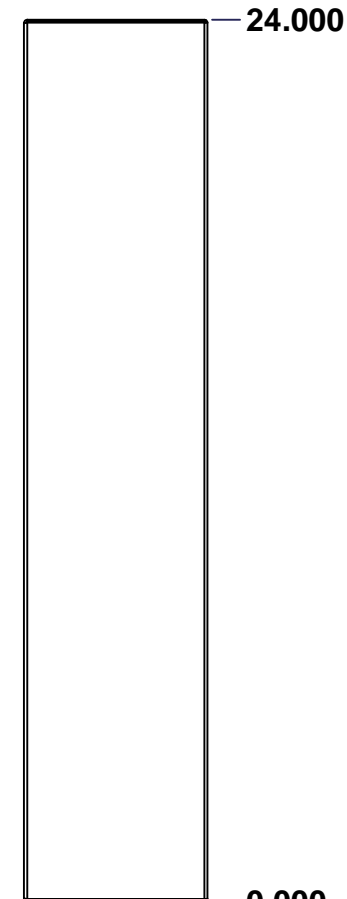

RIGHT

No.	Revisions	Date	By/Par

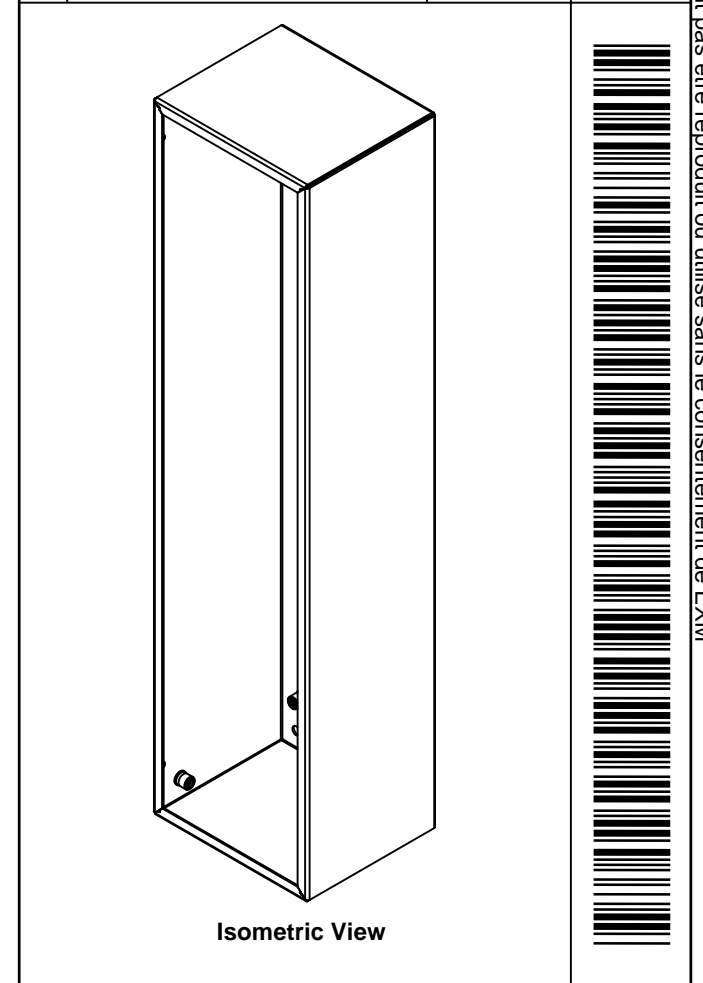

Isometric View

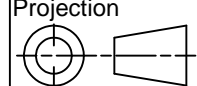
 Tél: (450) 979-4373 Fax: (450) 979-4626 www.exmweb.com		Flatness Aplatissement Max 3.0mm Projection 
Customer Client	Date	
Drawn By / Dessiné Par: BoxCad: JasonW	Date: 23/11/2014	
Material / Matière: 16 Ga H.R.P. & O. (1.4mm)		
Color / Couleur: Asa-61 Grey	Finish / Fini: Smooth	
Description: 1412CH 24" x 6" x 5" Body		Detail Rev.
Part Number / Numéro Pièce: 1412CH060524IPB		Rev.: 0

SEE BILL OF MATERIAL ON LAST PAGE

This drawing is confidential and must not be reproduced or used without the consent of EXM

Ce dessin est confidentiel et ne doit pas être reproduit ou utilisé sans le consentement de EXM

No.	Revisions	Date	By/Par

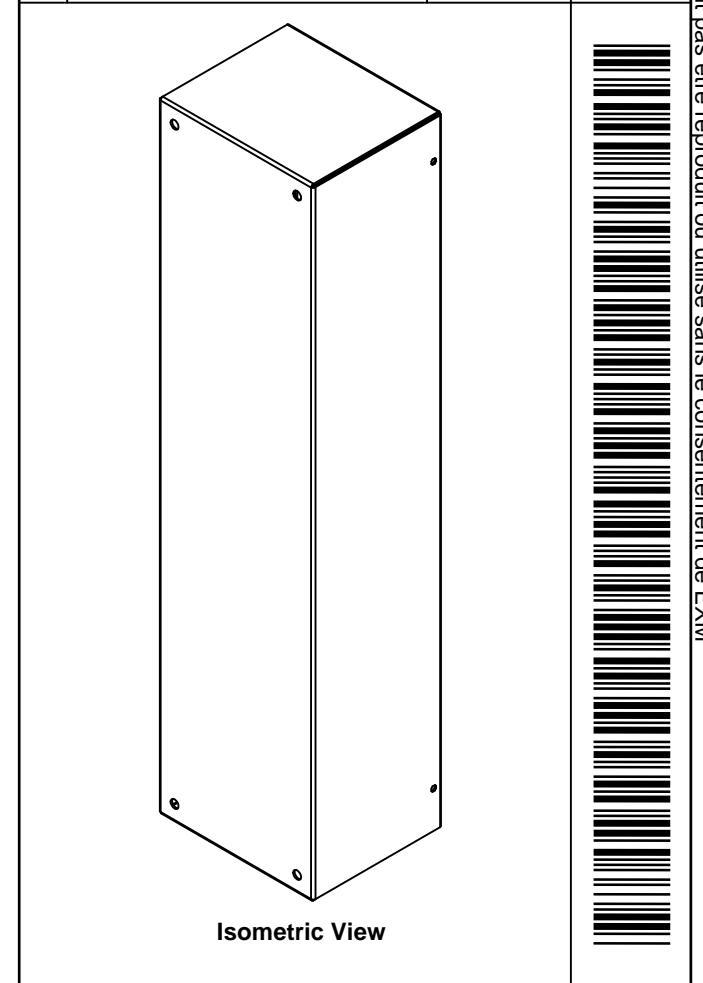

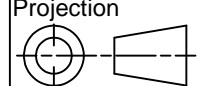
 Tél: (450) 979-4373 Fax: (450) 979-4626 www.exmweb.com		Flatness Aplatissement Max 3.0mm Projection 
Customer Client	Date	
Drawn By Dessiné Par	BoxCad: JasonW	Date 23/11/2014
Material Matière	16 Ga H.R.P. & O. (1.4mm)	
Color Couleur	Asa-61 Grey	Finish Fini Smooth
Description	Detail Rev.	
1412CH 24" x 6" x 5" Body		Rev. 0
Part Number Numéro Pièce 1412CH060524IPB		Rev. 0

Qty	Part_Number	Rev	Description
1	1412CH060524IPB-P	0	1412CH 24" x 6" x 5" Body Part
1	STK-P-02400S	0	Powder Paint (Asa-61 Grey / Smooth)
5	STK-Q-08350	4	Standoff M6 x 10mm
Parts List			

This drawing is confidential and must not be reproduced or used without the consent of EXM

Ce dessin est confidentiel et ne doit pas être reproduit ou utilisé sans le consentement de EXM

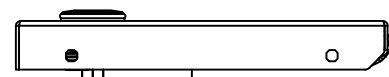

TOP

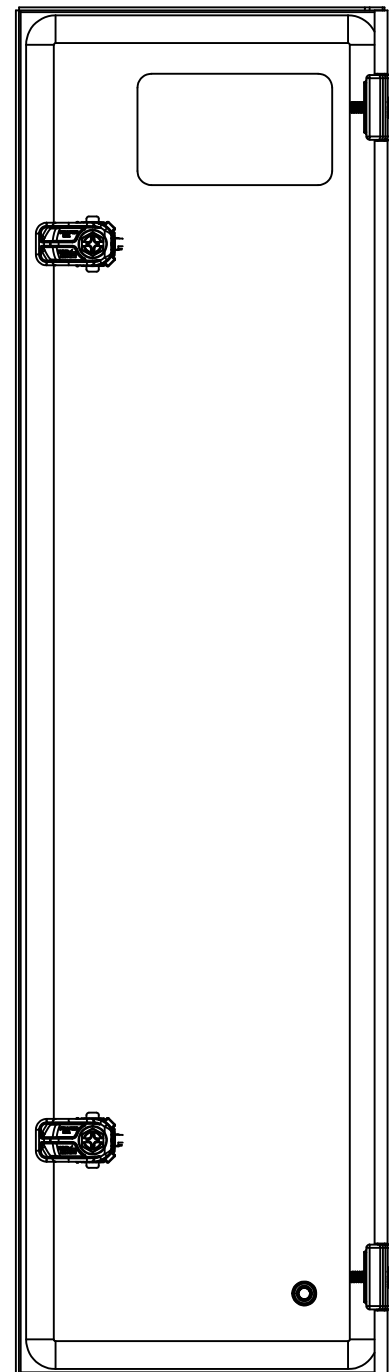

BACK

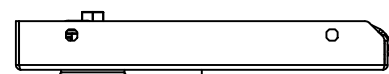

BOTTOM

0.000
0.875

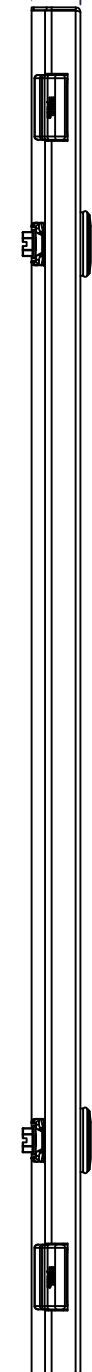

LEFT

0.000
6.687

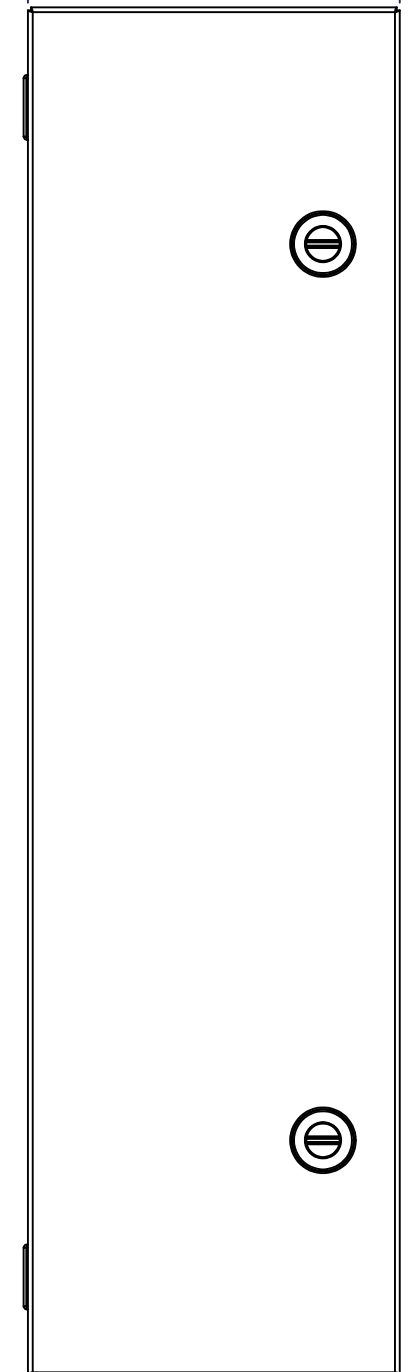

FRONT

24.592

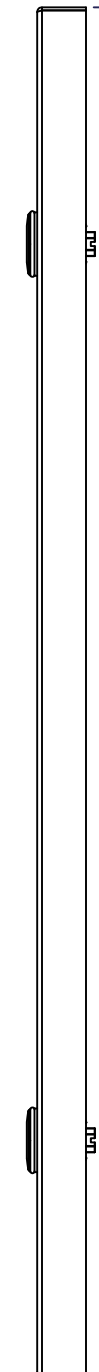

RIGHT

0.000

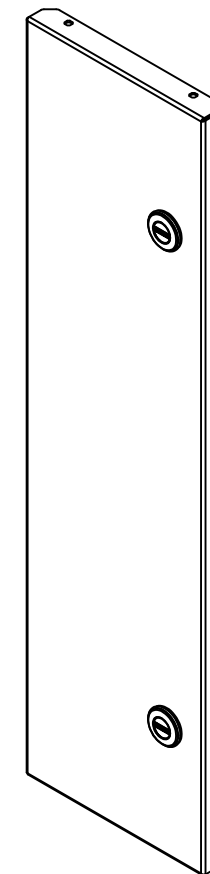

Isometric View

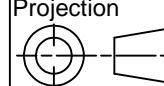

No.	Revisions	Date	By/Par

 Tél: (450) 979-4373 Fax: (450) 979-4626 www.exmweb.com		Flatness Aplatissement Max 3.0mm Projection 
Customer Client	Date	
Drawn By / Dessiné Par: BoxCad: JasonW	Date: 23/11/2014	
Material / Matière: 16 Ga H.R.P. & O. (1.4mm)	Color / Couleur: Asa-61 Grey	
Description: 1412CH 24" x 6" Cover		Finish / Fini: Smooth
Part Number / Numéro Pièce: 1412CH060524IPC	Detail Rev.:	Rev. 1 / 3

SEE BILL OF MATERIAL ON LAST PAGE

This drawing is confidential and must not be reproduced or used without the consent of EXM

Ce dessin est confidentiel et ne doit pas être reproduit ou utilisé sans le consentement de EXM

No.	Revisions	Date	By/Par

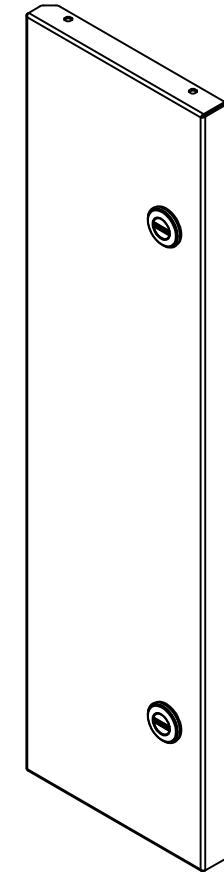

Isometric View

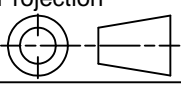

 Tél: (450) 979-4373 Fax: (450) 979-4626 www.exmweb.com	Flatness Aplatissement	Max 3.0mm
	Projection	
Customer Client	Date	
Drawn By Dessiné Par	BoxCad: JasonW	Date 23/11/2014
Material Matière	16 Ga H.R.P. & O. (1.4mm)	
Color Couleur	Asa-61 Grey	Finish Fini Smooth
Description	Detail Rev.	
1412CH 24" x 6" Cover		
Part Number Numéro Pièce	Rev.	3
1412CH060524IPC	0	3

Qty	Part Number	Rev	Description
1	STK-P-02400S	0	Powder Paint (Asa-61 Grey / Smooth)
1	STK-S-00100	0.1	3.5" x 2" Silver Milar Flexcon Sticker
		1	
1	STK-Q-08350	4	Standoff M6 x 10mm
1	1412CH060524IPG	0	1412CH 24" x 6" Gasket
1	1412CH060524IPC-P	0	1412CH 24" x 6" Cover Part
2	STK-A-33033	1	5412 ESMCH Hinge
2	880 SCQ4CH-SL	0	5412 CH 1/4 Turn Lock
Parts List			

This drawing is confidential and must not be reproduced or used without the consent of EXM

Ce dessin est confidentiel et ne doit pas être reproduit ou utilisé sans le consentement de EXM

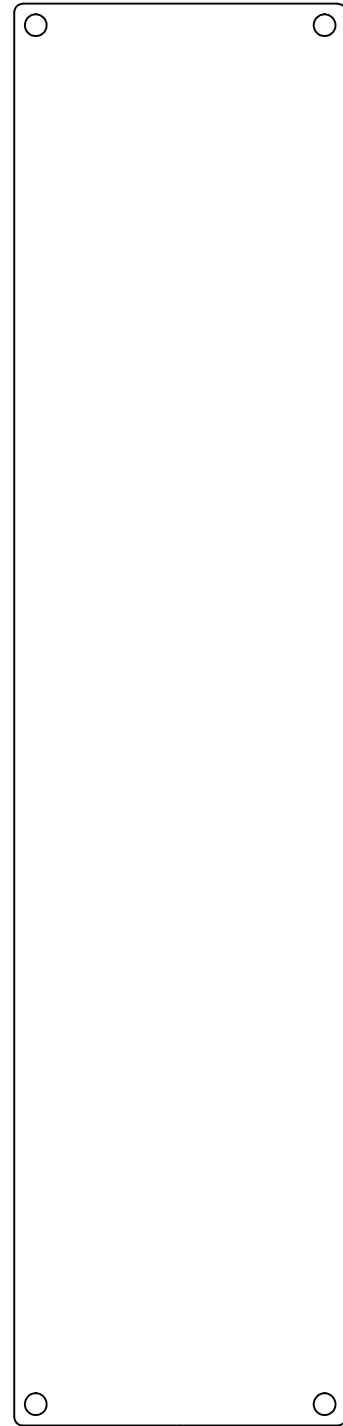
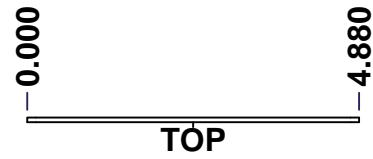

FRONT

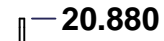

RIGHT 0.000

No.	Revisions	Date	By/Par

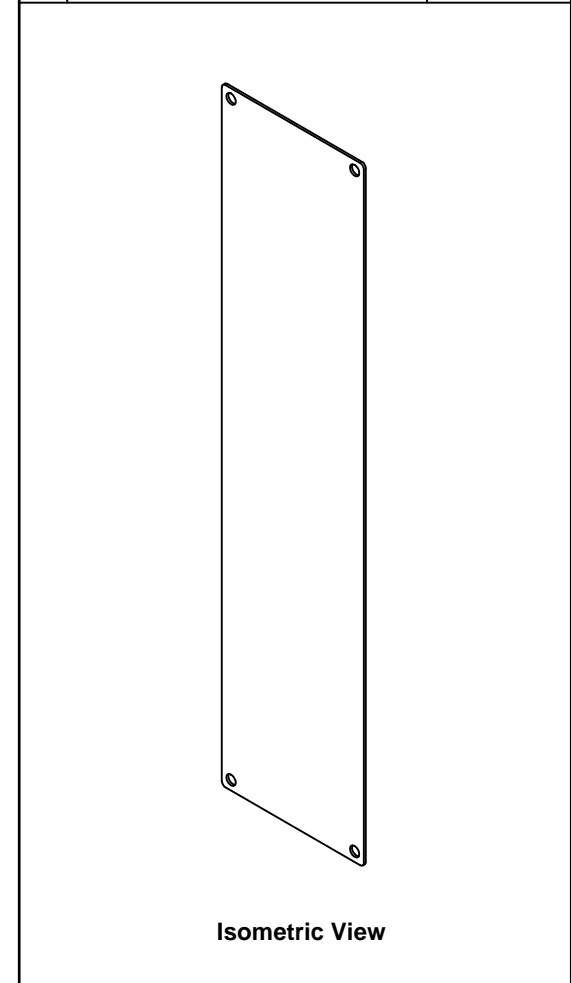

Isometric View

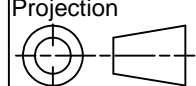

 Tél: (450) 979-4373 Fax: (450) 979-4626 www.exmweb.com		Flatness Aplatissement Max 3.0mm Projection 
Customer Client	Date	
Drawn By Dessiné Par	BoxCad: JasonW	Date 23/11/2014
Material Matière	14 Ga H.R.P. & O. (1.7mm)	
Color Couleur	White RAL9003	Finish Fini Smooth
Description 1412CH 24" x 6" Inner Panel Part		Detail Rev.
Part Number Numéro Pièce	1412CH060524PIP	Rev. 0
		1 3

SEE BILL OF MATERIAL ON LAST PAGE

This drawing is confidential and must not be reproduced or used without the consent of EXM

Ce dessin est confidentiel et ne doit pas être reproduit ou utilisé sans le consentement de EXM

No.	Revisions	Date	By/Par

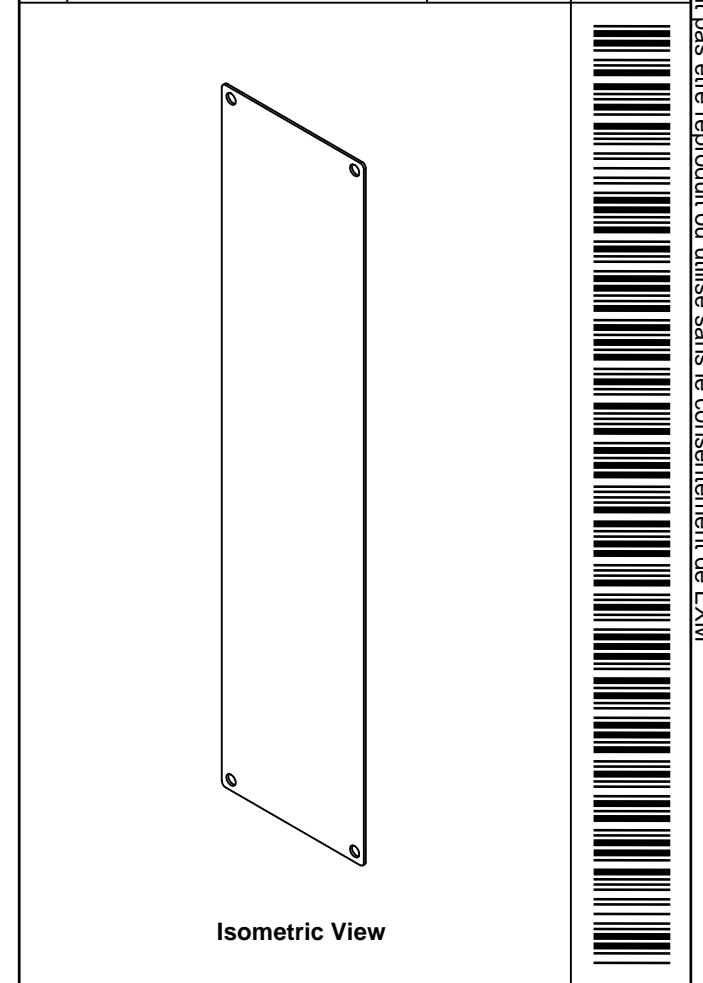

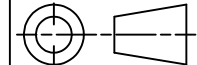
 Tél: (450) 979-4373 Fax: (450) 979-4626 www.exmweb.com		Flatness Aplatissement Max 3.0mm Projection 
Customer Client	Date	
Drawn By Dessiné Par	BoxCad: JasonW	Date 23/11/2014
Material Matière 14 Ga H.R.P. & O. (1.7mm)		
Color Couleur	White RAL9003	Finish Fini Smooth
Description 1412CH 24" x 6" Inner Panel Part		Detail Rev.
Part Number Numéro Pièce 1412CH060524IPIP		Rev. 3 0 3

Qty	Part Number	Rev	Description
1	STK-P-02401S	0	Powder Paint (White / Smooth)
1	1412CH060524IPIP-P	0	1412CH 24" x 6" Inner Panel Part
Parts List			