

This drawing is confidential and must not be reproduced or used without the consent of EXM

Ce dessin est confidentiel et ne doit pas être reproduit ou utilisé sans le consentement de EXM

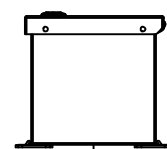

TOP

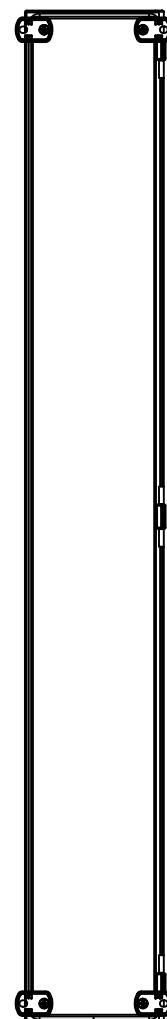

BACK

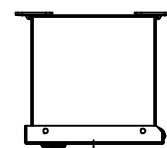

BOTTOM

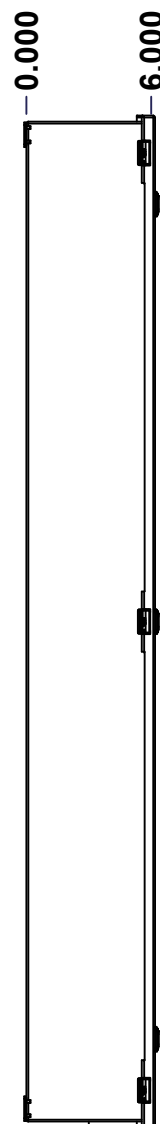

LEFT

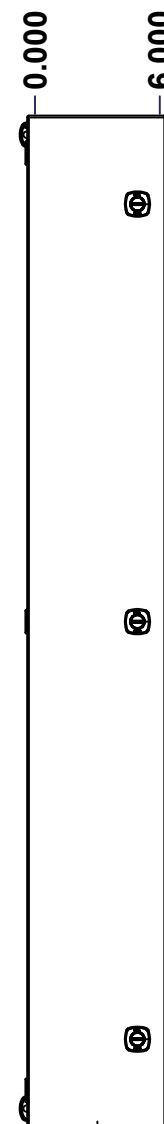

FRONT

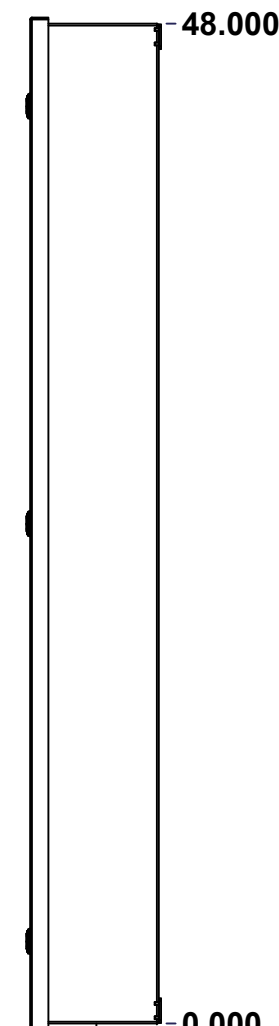

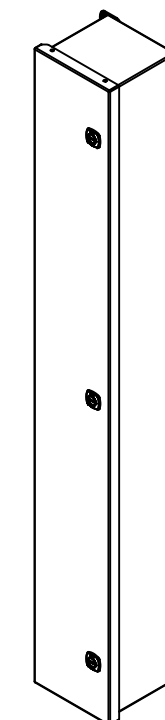

RIGHT



Isometric View



No.	Revisions	Date	By/Par

 Tél: (450) 979-4373 Fax: (450) 979-4626 www.exmweb.com		Flatness Aplatissement Max 3.0mm Projection 
Customer Client	Date	Date
Drawn By Dessiné Par	BoxCad: BoxCad	Date 16-Mar-16
Material Matière	16 Ga Stainless Steel 304 (1.4mm)	
Color Couleur	Unpainted	Finish Fini Brushed
Description	1412CH 48" x 6" x 6" Assembly	
Part Number Numéro Pièce	Rev. 0	1 2

SEE BILL OF MATERIAL ON LAST PAGE

1412CHSS060648

This drawing is confidential and must not be reproduced or used without the consent of EXM

Ce dessin est confidentiel et ne doit pas être reproduit ou utilisé sans le consentement de EXM

NOTE	
ITEM	DESCRIPTION
1	NEMA 4/12 Enclosure
2	C/W Standard ground standoffs on box and cover
3	W/O Standard door stiffener
4	W/O Inner panel
5	W/O Inner panel mounting standoffs
6	C/W Special locks sold separately (Kit)

No.	Revisions	Date	By/Par

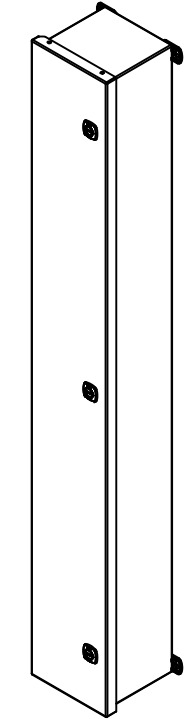

Isometric View

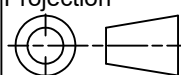

 Tél: (450) 979-4373 Fax: (450) 979-4626 www.exmweb.com		Flatness Aplatissement Max 3.0mm Projection 
Customer Client	Date	
Drawn By Dessiné Par	BoxCad: BoxCad	Date 16-Mar-16
Material Matière	16 Ga Stainless Steel 304 (1.4mm)	
Color Couleur	Unpainted	Finish Fini Brushed
Description	Detail Rev.	
1412CH 48" x 6" x 6" Assembly		
Part Number Numéro Pièce	1412CHSS060648	Rev. 2 0

PACKING		
ITEM	QTY	DESCRIPTION
Cardboard sleeve	1	Top
Thermal plastic film	1	Use with Packing Tunnel Wrapper Machine
Packaging label	1	White label with product number

Qty	Part Number	Rev	Description
1	1412CHSS060648C	0	1412CH 48" x 6" Cover
1	1412CHSS060648B	0	1412CH 48" x 6" x 6" Body
2	STK-K-02575	0	1412 CHSS Accessory Kit
3	STK-Q-08100	1	M5 Nylon Insert Lock Nut
Parts List			

This drawing is confidential and must not be reproduced or used without the consent of EXM

Ce dessin est confidentiel et ne doit pas être reproduit ou utilisé sans le consentement de EXM

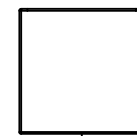

TOP



BACK

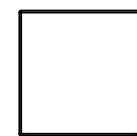

BOTTOM

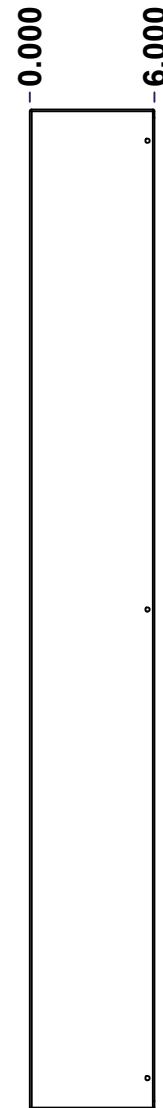

LEFT

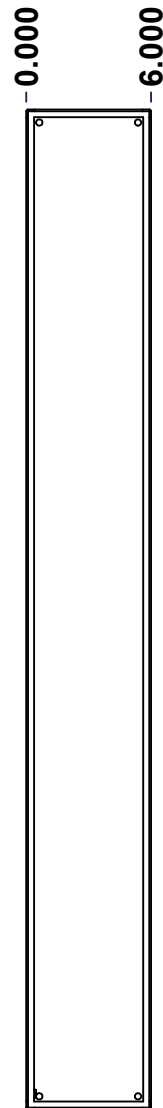

FRONT

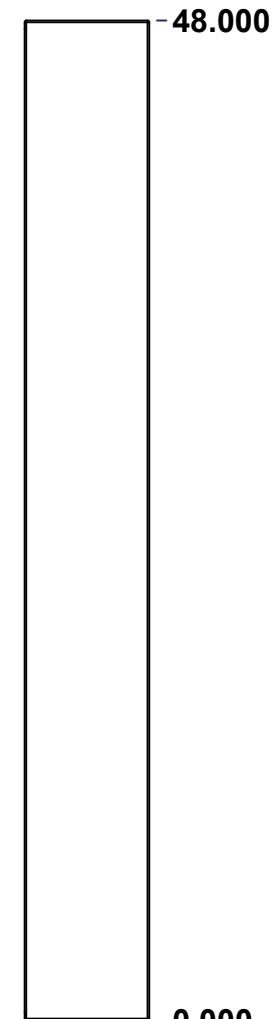

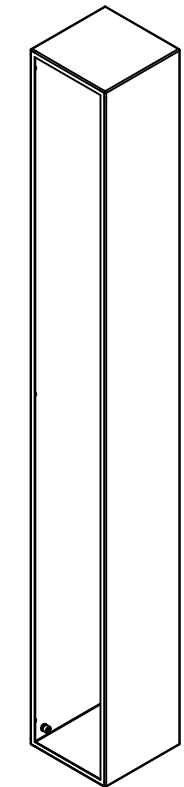

RIGHT



Isometric View

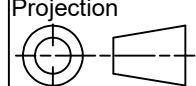

No.	Revisions	Date	By/Par

 Tél: (450) 979-4373 Fax: (450) 979-4626 www.exmweb.com		Flatness Aplatissement  Max 3.0mm Projection 
Customer Client	Date	
Drawn By Dessiné Par	BoxCad: BoxCad	Date 16-Mar-16
Material Matière	16 Ga Stainless Steel 304 (1.4mm)	
Color Couleur	Unpainted	Finish Fini Brushed
Description	Detail Rev.	
1412CH 48" x 6" x 6" Body		
Part Number Numéro Pièce	Rev.	1 7
1412CHSS060648B	0	

SEE BILL OF MATERIAL ON LAST PAGE

This drawing is confidential and must not be reproduced or used without the consent of EXM

Ce dessin est confidentiel et ne doit pas être reproduit ou utilisé sans le consentement de EXM

No.	Revisions	Date	By/Par

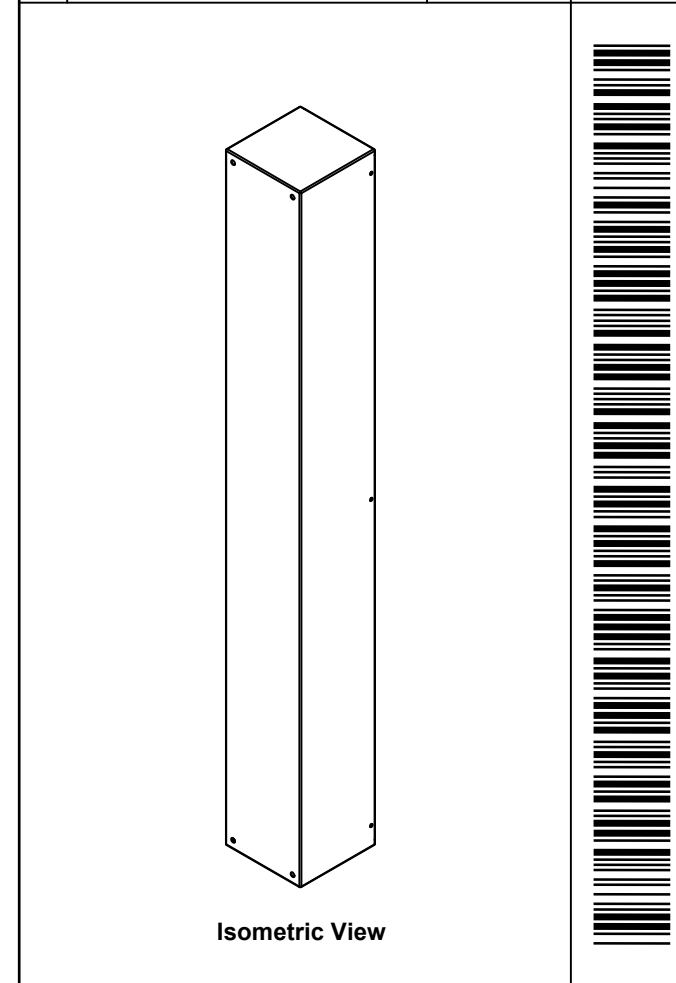

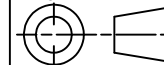
 Tél: (450) 979-4373 Fax: (450) 979-4626 www.exmweb.com		Flatness Aplatissement Max 3.0mm Projection 
Customer Client	Date	
Drawn By Dessiné Par	BoxCad: BoxCad	Date 16-Mar-16
Material Matière	16 Ga Stainless Steel 304 (1.4mm)	
Color Couleur	Unpainted	Finish Fini Brushed
Description	Detail Rev.	
1412CH 48" x 6" x 6" Body		
Part Number Numéro Pièce	Rev.	7
1412CHSS060648B	0	7

Qty	Part_Number	Rev	Description
1	1412CHSS060648B-P	0	1412CH 48" x 6" x 6" Body Part
1	STK-Q-08500	4	Stainless Steel Standoff M6 x 10mm
Parts List			

This drawing is confidential and must not be reproduced or used without the consent of EXM

Ce dessin est confidentiel et ne doit pas être reproduit ou utilisé sans le consentement de EXM

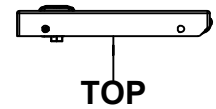

TOP

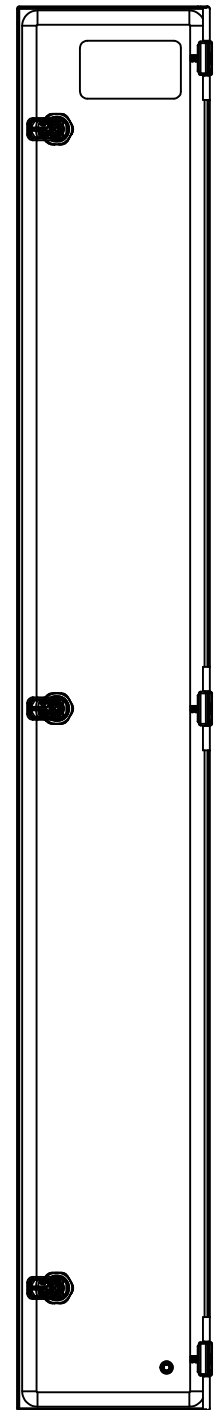

BACK

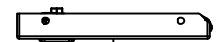

BOTTOM

0.000
0.875

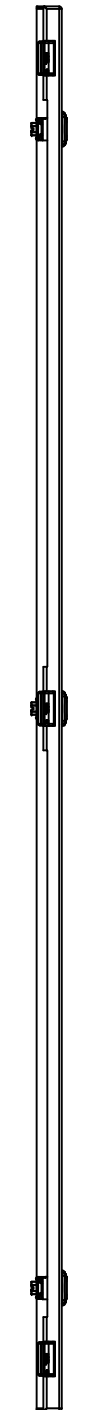

LEFT

0.000
6.687

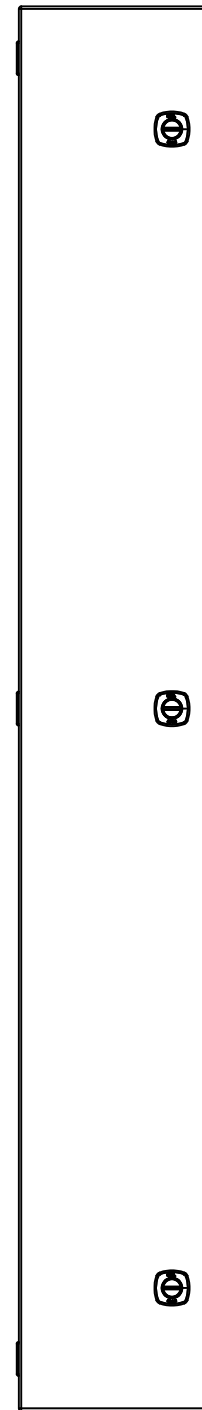

FRONT

48.592



RIGHT

0.000

No.	Revisions	Date	By/Par

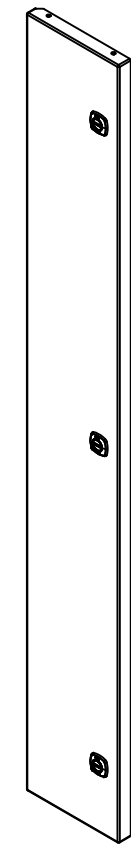

Isometric View



Tél: (450) 979-4373
Fax: (450) 979-4626
www.exmweb.com

Flatness
Aplatissement

Max 3.0mm

Projection

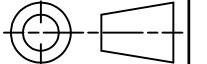

Customer Client	Date
Drawn By / Dessiné Par: BoxCad: BoxCad	Date: 16-Mar-16
Material / Matière: 16 Ga Stainless Steel 304 (1.4mm)	

Color / Couleur: Unpainted	Finish / Fini: Brushed
----------------------------	------------------------

Description: 1412CH 48" x 6" Cover	Detail Rev.
------------------------------------	-------------

Part Number / Numéro Pièce: 1412CHSS060648C	Rev. 0	1 / 3
---	--------	-------

SEE BILL OF MATERIAL ON LAST PAGE

This drawing is confidential and must not be reproduced or used without the consent of EXM

Ce dessin est confidentiel et ne doit pas être reproduit ou utilisé sans le consentement de EXM

STANDARD FEATURES ARE NOT LISTED IN THIS HOLE TABLE			
HOLE TABLE - FRONT VIEW (CUSTOM FEATURE ONLY)			
CUT-OUT	XDIM	YDIM	DESCRIPTION
1	5.307	44.342	LOCK 880 SCQ4CH-SLSS @ 180.0°
2	5.307	24.296	LOCK 880 SCQ4CH-SLSS @ 180.0°
3	5.307	4.250	LOCK 880 SCQ4CH-SLSS @ 180.0°

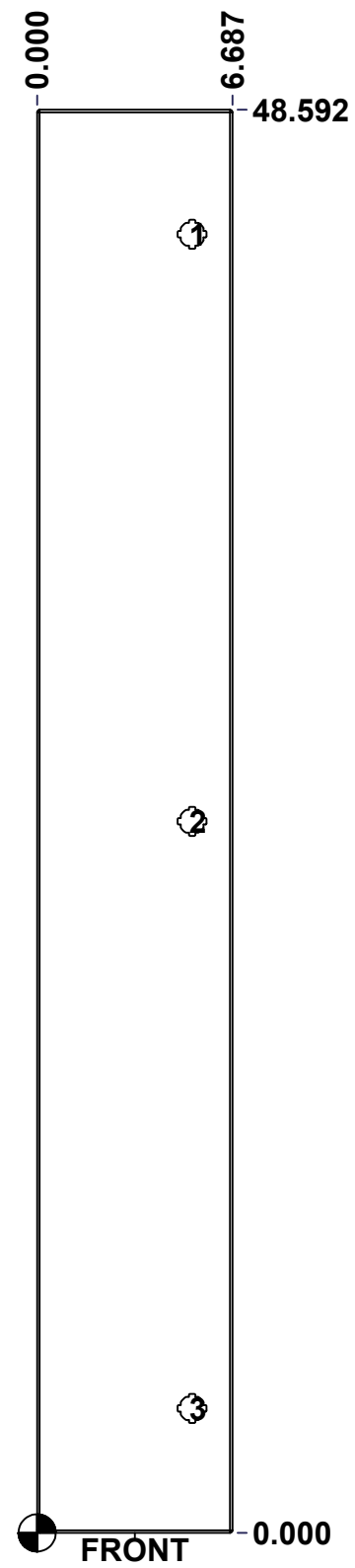



	Description	Status	
	1412CH 48" x 6" Cover	(NULL)	
	Part Number Numéro Pièce	Rev.	
	1412CHSS060648C	0	2 3

This drawing is confidential and must not be reproduced or used without the consent of EXM

Ce dessin est confidentiel et ne doit pas être reproduit ou utilisé sans le consentement de EXM

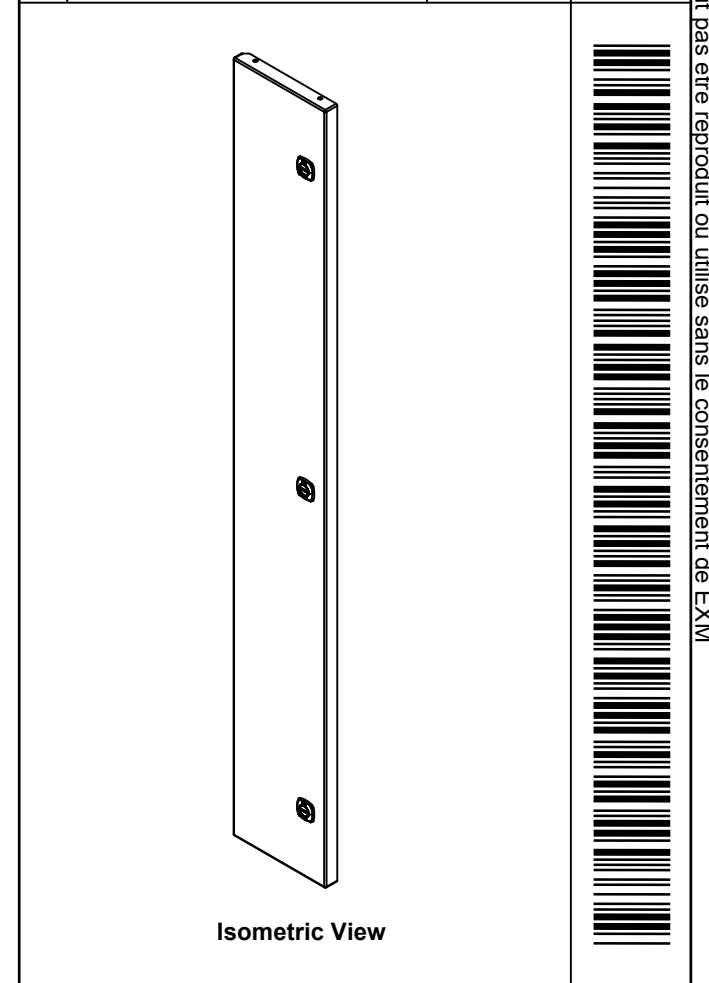
No.	Revisions	Date	By/Par

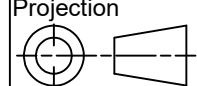

 Tél: (450) 979-4373 Fax: (450) 979-4626 www.exmweb.com		Flatness Aplatissement Max 3.0mm Projection 
Customer Client	Date	
Drawn By Dessiné Par	BoxCad: BoxCad	Date 16-Mar-16
Material Matière	16 Ga Stainless Steel 304 (1.4mm)	
Color Couleur	Unpainted	Finish Fini Brushed
Description		Detail Rev.
1412CH 48" x 6" Cover		
Part Number Numéro Pièce	Rev.	3
1412CHSS060648C	0	3

Qty	Part Number	Rev	Description
1	1412CHSS060648G	0	1412CH 48" x 6" Gasket
1	STK-S-00100	0	3.5" x 2" Silver Milar Flexcon Sticker
1	STK-Q-08500	4	Stainless Steel Standoff M6 x 10mm
1	1412CHSS060648C-P	0	1412CH 48" x 6" Cover Part
3	STK-A-33038	3	5412 ESSMCH - Stainless Steel Hinge
3	880 SCQ4CH-SLSS	0	5412 CHSS 1/4 Turn Lock
Parts List			