

This drawing is confidential and must not be reproduced or used without the consent of EXM

Ce dessin est confidentiel et ne doit pas être reproduit ou utilisé sans le consentement de EXM

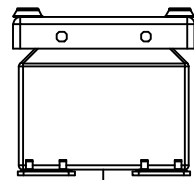

TOP

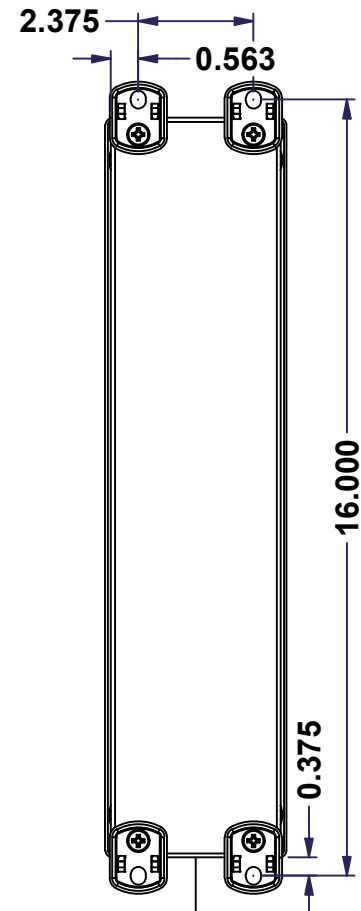

BACK

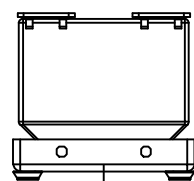

BOTTOM



LEFT

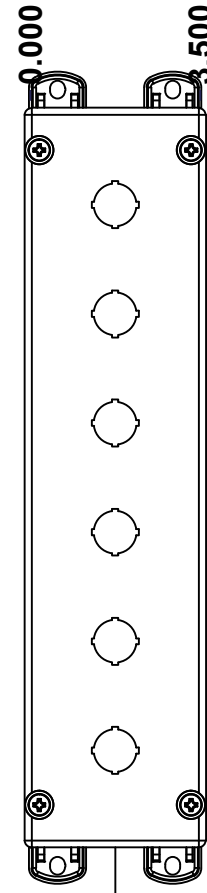

FRONT

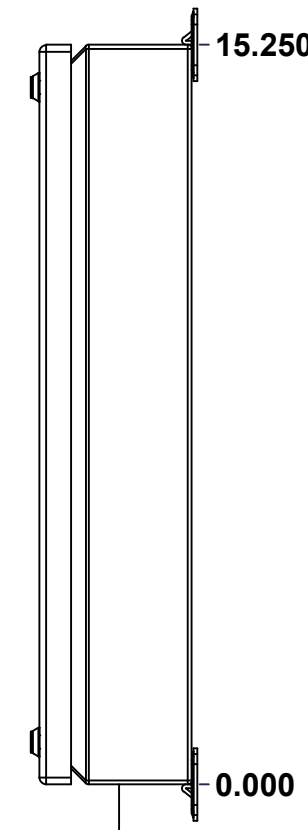

RIGHT

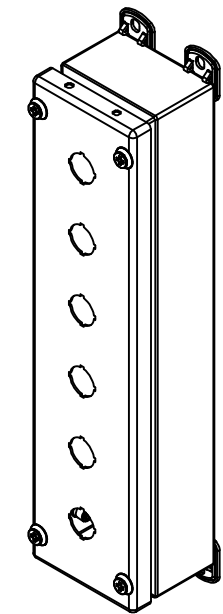

Isometric View

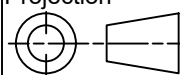

No.	Revisions	Date	By/Par

 Tél: (450) 979-4373 Fax: (450) 979-4626 <a href="http://www.exmweb.com">www.exmweb.com</a>		Flatness Aplatissement Max 3.0mm Projection 
Customer Client	Date	
Drawn By Dessiné Par	BoxCad: BoxCad	Date 18-Dec-23
Material Matière	16 Ga Cold Rolled A1008 CS Type B (1.4mm)	
Color Couleur	Asa-61 Grey	Finish Fini Smooth
Description	1412SDMN 15.25" x 3.5" x 3" Assembly	
Part Number Numéro Pièce	1412SD140302MN	Detail Rev. Rev. 1 0 / 9

SEE BILL OF MATERIAL ON LAST PAGE

This drawing is confidential and must not be reproduced or used without the consent of EXM

Ce dessin est confidentiel et ne doit pas être reproduit ou utilisé sans le consentement de EXM

NOTE	
ITEM	DESCRIPTION
1	NEMA 4, 12 Enclosure (IP66)
2	C/W Standard ground standoffs on box only
3	W/O Standard door stiffener
4	W/O Inner panel
5	W/O Inner panel mounting standoffs
6	C/W 885 ESCHMF1 Mounting Feet (Installed)

No.	Revisions	Date	By/Par

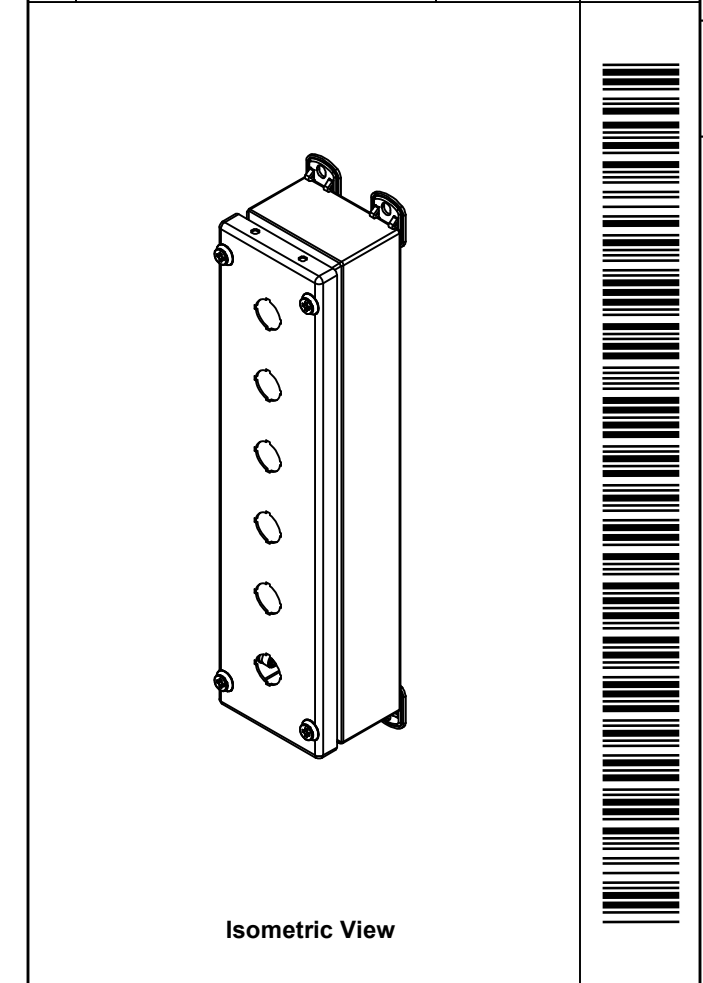

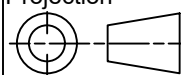
 Tél: (450) 979-4373 Fax: (450) 979-4626 <a href="http://www.exmweb.com">www.exmweb.com</a>	Flatness Aplatissement Max 3.0mm
	Projection 
Customer Client	Date
Drawn By Dessiné Par BoxCad: BoxCad	Date 18-Dec-23
Material Matière 16 Ga Cold Rolled A1008 CS Type B (1.4mm)	
Color Couleur Asa-61 Grey	Finish Fini Smooth
Description 1412SDMN 15.25" x 3.5" x 3" Assembly	Detail Rev.
Part Number Numéro Pièce <b>1412SD140302MN</b>	Rev. 2 <b>0</b> 9

PACKING		
ITEM	QTY	DESCRIPTION
Cardboard sleeve	2	Top and Bottom
Cardboard strip	2	Between back of enclosure and inner panel
Plastic bag	1	To protect cover surface and inside gasket
Plastic strap - Black	2	To Squeeze the 2 cardboard sleeve together
Packaging label	1	White label with product number

Qty	Part Number	Rev	Description
1	STK-K-02920	3	5412 ESSC Accessory Kit
1	1412SD140302MNC	0	1412SDMN 15.25" x 3.5" Cover
1	1412SD140302MNB	0	1412SDMN 15.25" x 3.5" x 3" Body
Parts List			

This drawing is confidential and must not be reproduced or used without the consent of EXM

Ce dessin est confidentiel et ne doit pas être reproduit ou utilisé sans le consentement de EXM

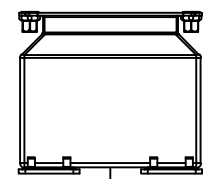

TOP

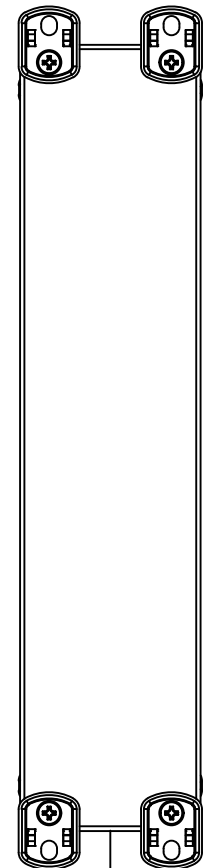

BACK

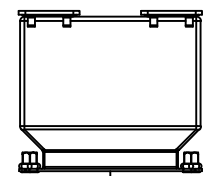

BOTTOM

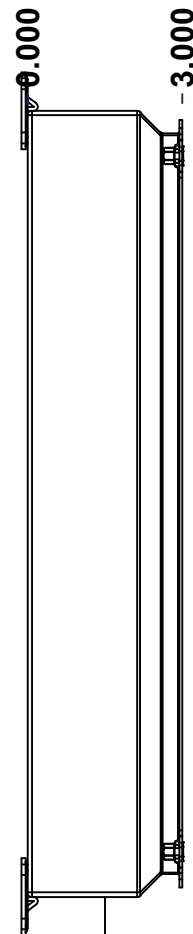

LEFT

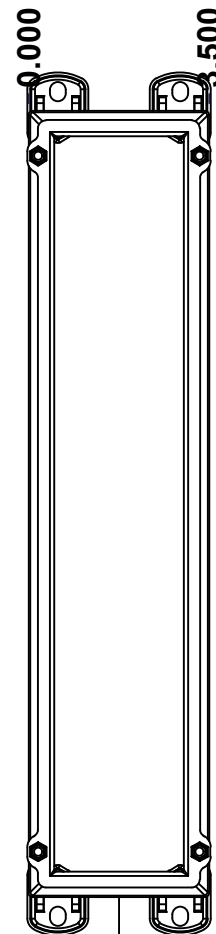

FRONT

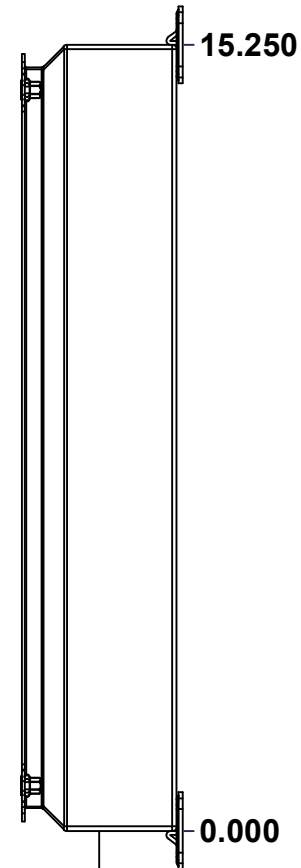

RIGHT

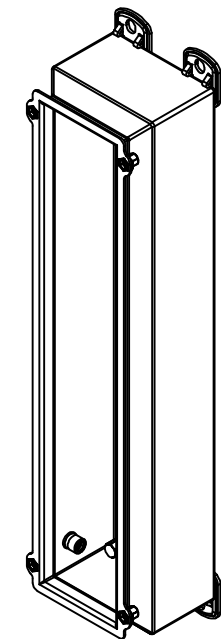

Isometric View

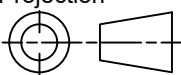

No.	Revisions	Date	By/Par

 Tél: (450) 979-4373 Fax: (450) 979-4626 <a href="http://www.exmweb.com">www.exmweb.com</a>		Flatness Aplatissement Max 3.0mm Projection 
Customer Client	Date	
Drawn By / Dessiné Par: BoxCad: BoxCad	Date: 18-Dec-23	
Material / Matière: 16 Ga Cold Rolled A1008 CS Type B (1.4mm)		
Color / Couleur: Asa-61 Grey	Finish / Fini: Smooth	
Description: 1412SDMN 15.25" x 3.5" x 3" Body	Detail Rev.	
Part Number / Numéro Pièce: 1412SD140302MNB	Rev. 0	3 / 9

SEE BILL OF MATERIAL ON LAST PAGE

This drawing is confidential and must not be reproduced or used without the consent of EXM

Ce dessin est confidentiel et ne doit pas être reproduit ou utilisé sans le consentement de EXM

<b>STANDARD FEATURES ARE NOT LISTED IN THIS HOLE TABLE</b>			
<b>HOLE TABLE - LEFT VIEW (CUSTOM FEATURE ONLY)</b>			
CUT-OUT	XDIM	YDIM	DESCRIPTION
1	1.625	0.875	STANDOFF M6 x 10mm (Inside)

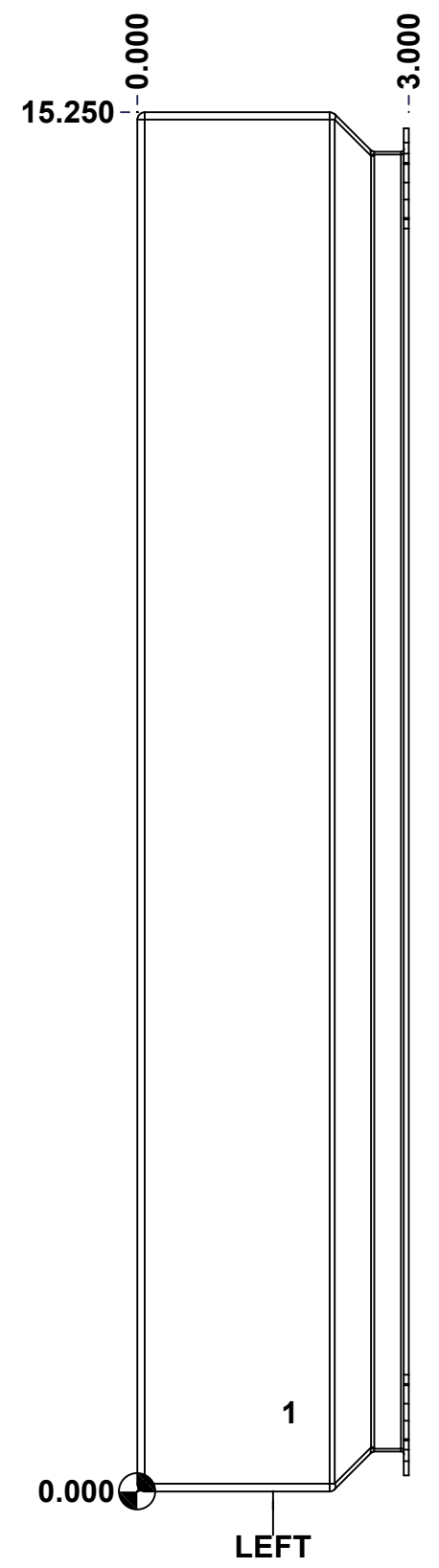

	Description	Status	
	1412SDMN 15.25" x 3.5" x 3" Body	(NULL)	
	Part Number Numéro Pièce	Rev.	
	<b>1412SD140302MNB</b>	<b>0</b>	4 9

This drawing is confidential and must not be reproduced or used without the consent of EXM

Ce dessin est confidentiel et ne doit pas être reproduit ou utilisé sans le consentement de EXM

**STANDARD FEATURES ARE NOT LISTED IN THIS HOLE TABLE**

**HOLE TABLE - BACK VIEW (CUSTOM FEATURE ONLY)**

CUT-OUT	XDIM	YDIM	DESCRIPTION
1	0.563	15.250	FOOT 885 ESCHMF1
2	2.937	15.250	FOOT 885 ESCHMF1
3	2.937	0.000	FOOT 885 ESCHMF1
4	0.563	0.000	FOOT 885 ESCHMF1
5	0.563	14.906	RIVET NUT M6_FH_CE (Inside)
6	2.937	14.906	RIVET NUT M6_FH_CE (Inside)
7	2.937	0.344	RIVET NUT M6_FH_CE (Inside)
8	0.563	0.344	RIVET NUT M6_FH_CE (Inside)

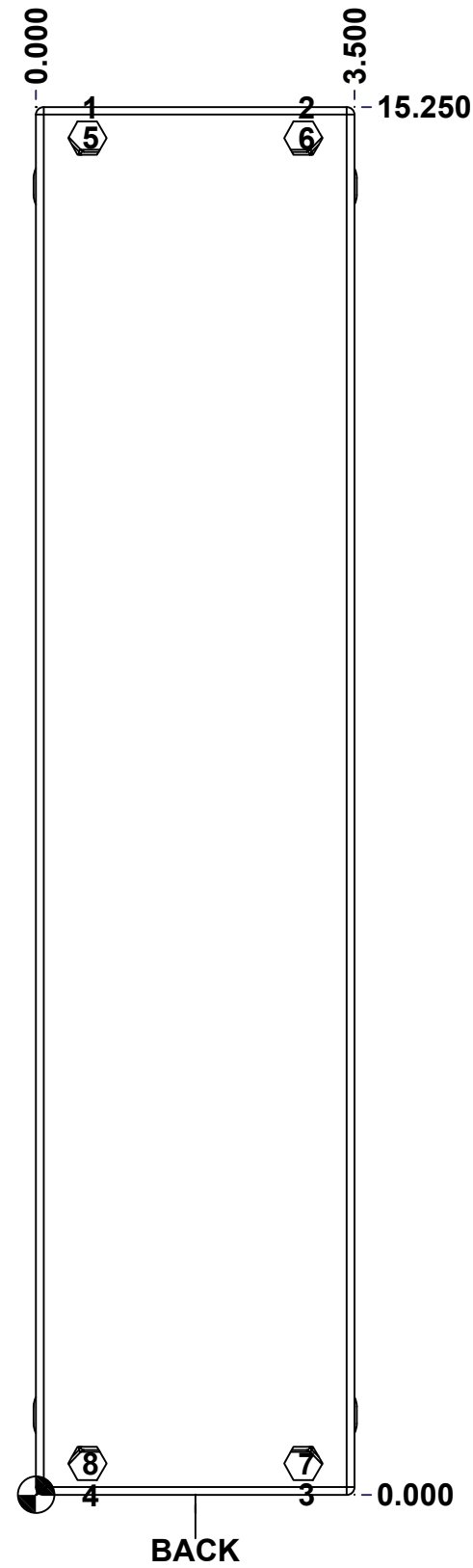

	Description	Status	
	1412SDMN 15.25" x 3.5" x 3" Body	(NULL)	
	Part Number Numéro Pièce	Rev.	5
	<b>1412SD140302MNB</b>	<b>0</b>	9

This drawing is confidential and must not be reproduced or used without the consent of EXM

Ce dessin est confidentiel et ne doit pas être reproduit ou utilisé sans le consentement de EXM

No.	Revisions	Date	By/Par

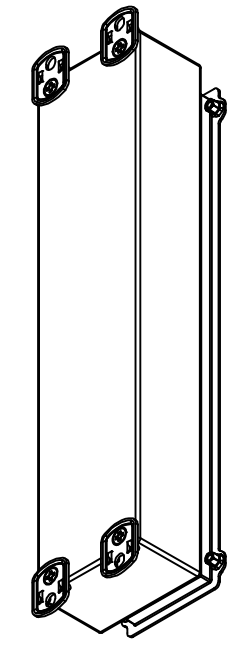

Isometric View

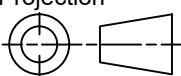

 Tél: (450) 979-4373 Fax: (450) 979-4626 <a href="http://www.exmweb.com">www.exmweb.com</a>	Flatness Aplatissement	Max 3.0mm
	Projection	
Customer Client	Date	
Drawn By Dessiné Par	BoxCad: BoxCad	Date 18-Dec-23
Material Matière	16 Ga Cold Rolled A1008 CS Type B (1.4mm)	
Color Couleur	Asa-61 Grey	Finish Fini Smooth
Description	Detail Rev.	
1412SDMN 15.25" x 3.5" x 3" Body		
Part Number Numéro Pièce	Rev.	6
<b>1412SD140302MNB</b>	<b>0</b>	9

Qty	Part Number	Rev	Description
1	STK-Q-08350	5	Standoff M6 x 10mm
4	RIVET_NUT_M6_FH_CE	0	Rivet Nut M6 (Low Profile Close End)
4	STK-Q-03071	0	M6 x 16mm Machine Screw
1	STK-P-02400S	0	Powder Paint (Asa-61 Grey / Smooth)
1	1412SD140302MNB-P	0	1412SDMN 15.25" x 3.5" x 3" Body Part
4	885 ESCHMF1	2	5412 ESCH Stamped Mounting Foot
4	RIVET_NUT_M5_FH_OE	0	Rivet Nut M5 (Low Profile Open End)
Parts List			

This drawing is confidential and must not be reproduced or used without the consent of EXM

Ce dessin est confidentiel et ne doit pas être reproduit ou utilisé sans le consentement de EXM

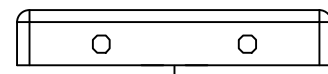

TOP

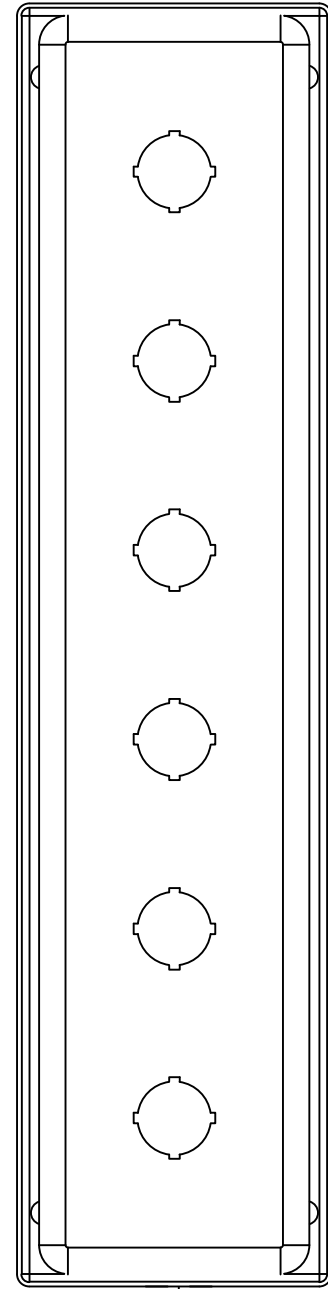

BACK

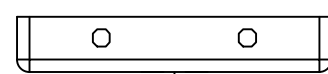

BOTTOM

0.000  
0.656

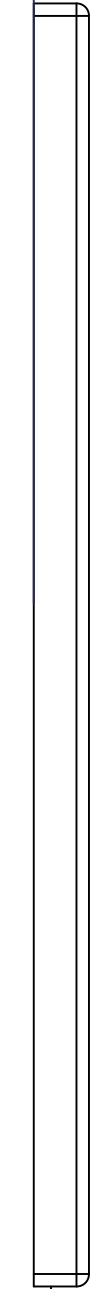

LEFT

0.000  
3.736

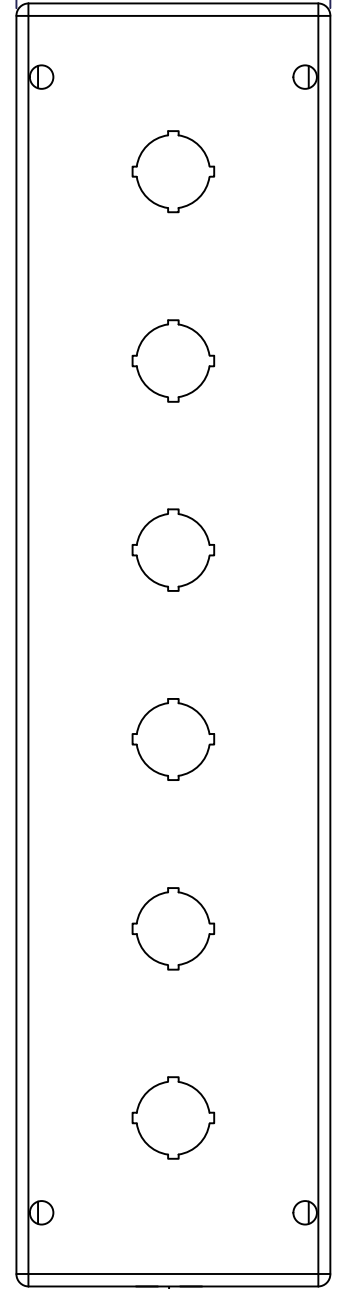

FRONT

15.250

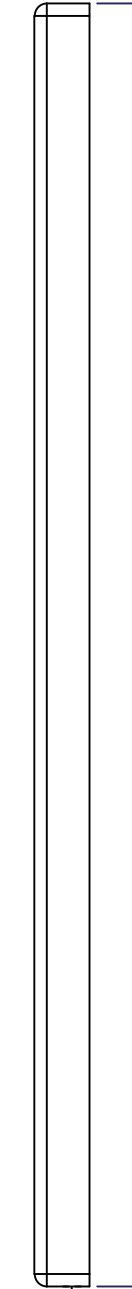

RIGHT

0.000

No.	Revisions	Date	By/Par

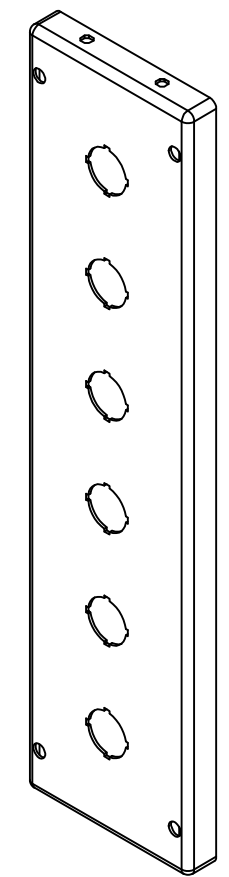

Isometric View



<p>Tél: (450) 979-4373 Fax: (450) 979-4626 <a href="http://www.exmweb.com">www.exmweb.com</a></p>	Flatness Aplatissement	Max 3.0mm
	Projection	
Customer Client	Date	
Drawn By Dessiné Par	BoxCad: BoxCad	Date 18-Dec-23
Material Matière	16 Ga Cold Rolled A1008 CS Type B (1.4mm)	
Color Couleur	Asa-61 Grey	Finish Fini Smooth
Description	1412SDMN 15.25" x 3.5" Cover	
Part Number Numéro Pièce	Rev. 0	7 9

SEE BILL OF MATERIAL ON LAST PAGE

**1412SD140302MNC**

This drawing is confidential and must not be reproduced or used without the consent of EXM

Ce dessin est confidentiel et ne doit pas être reproduit ou utilisé sans le consentement de EXM

**STANDARD FEATURES ARE NOT LISTED IN THIS HOLE TABLE**

**HOLE TABLE - FRONT VIEW (CUSTOM FEATURE ONLY)**

CUT-OUT	XDIM	YDIM	DESCRIPTION
1	1.868	2.000	22.5 mm Miniature Pushbutton
2	1.868	4.250	22.5 mm Miniature Pushbutton
3	1.868	6.500	22.5 mm Miniature Pushbutton
4	1.868	8.750	22.5 mm Miniature Pushbutton
5	1.868	11.000	22.5 mm Miniature Pushbutton
6	1.868	13.250	22.5 mm Miniature Pushbutton

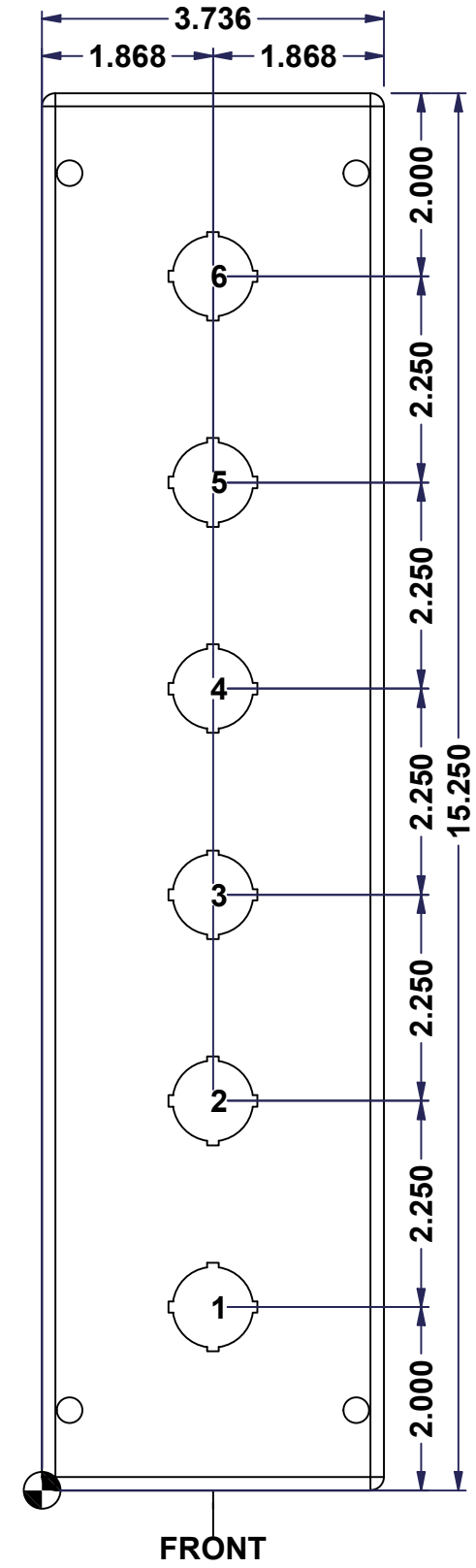

	Description	Status
	1412SDMN 15.25" x 3.5" Cover	(NULL)
Part Number Numéro Pièce <b>1412SD140302MNC</b>	Rev.	8
	<b>0</b>	9



This drawing is confidential and must not be reproduced or used without the consent of EXM

Ce dessin est confidentiel et ne doit pas être reproduit ou utilisé sans le consentement de EXM

No.	Revisions	Date	By/Par

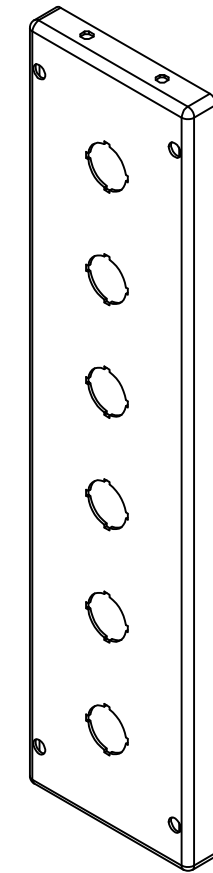

Isometric View

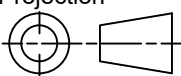

 Tél: (450) 979-4373 Fax: (450) 979-4626 <a href="http://www.exmweb.com">www.exmweb.com</a>		Flatness Aplatissement Max 3.0mm
Customer Client		Projection 
Drawn By / Dessiné Par: BoxCad: BoxCad		Date: 18-Dec-23
Material / Matière: 16 Ga Cold Rolled A1008 CS Type B (1.4mm)		
Color / Couleur: Asa-61 Grey	Finish / Fini: Smooth	
Description: 1412SDMN 15.25" x 3.5" Cover		Detail Rev.
Part Number / Numéro Pièce: <b>1412SD140302MNC</b>		Rev. 0 / 9

Qty	Part Number	Rev	Description
1	STK-P-02400S	0	Powder Paint (Asa-61 Grey / Smooth)
1	1412SD140302MNG	0	1412SD 15.25" x 3.5" Gasket
1	1412SD140302MNC-P	0	1412SDMN 15.25" x 3.5" Cover Part
Parts List			