

This drawing is confidential and must not be reproduced or used without the consent of EXM

Ce dessin est confidentiel et ne doit pas être reproduit ou utilisé sans le consentement de EXM

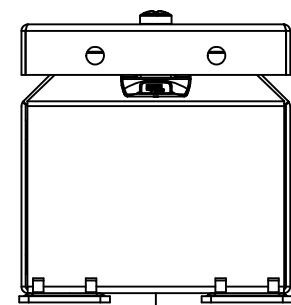

TOP

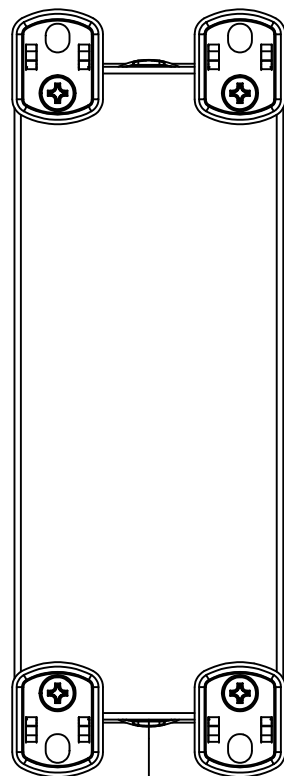

BACK

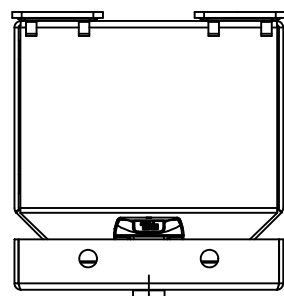

BOTTOM

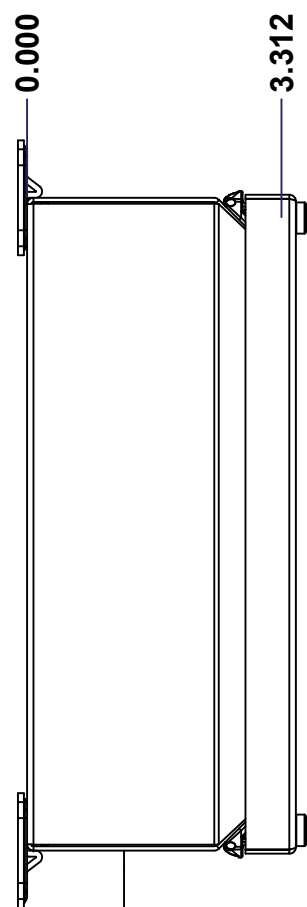

LEFT

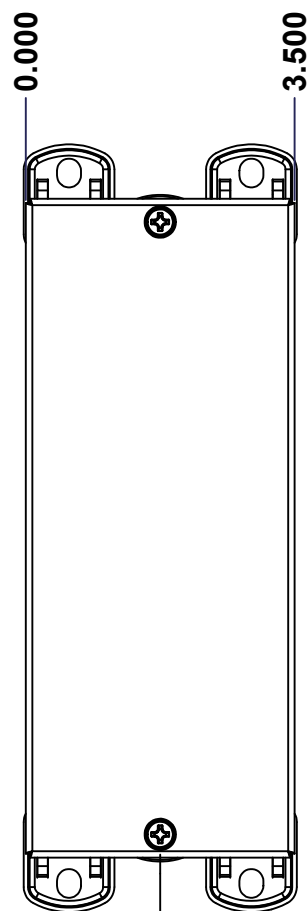

FRONT

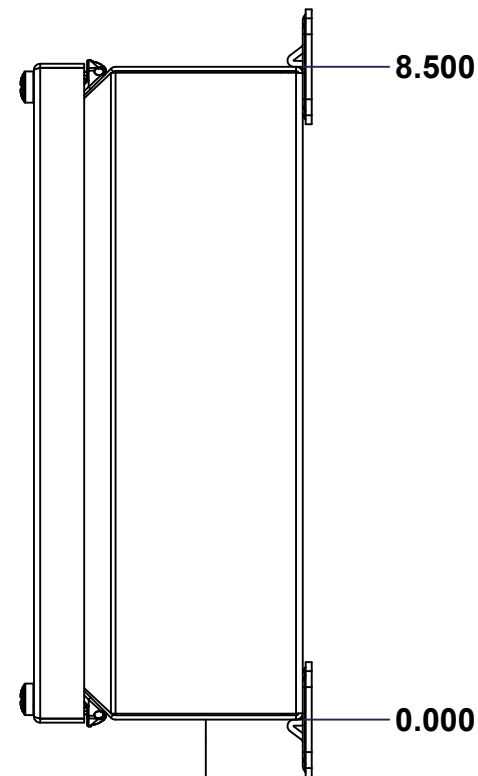

RIGHT

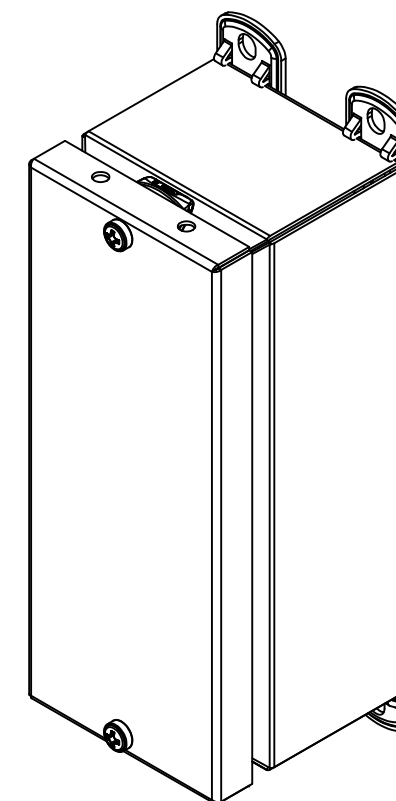

Isometric View

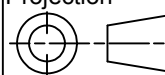

No.	Revisions	Date	By/Par

 Tél: (450) 979-4373 Fax: (450) 979-4626 www.exmweb.com		Flatness Aplatissement Max 3.0mm Projection 
Customer Client	Date	
Drawn By Dessiné Par	BoxCad: patsan	Date 06/06/2013
Material Matière	16 Ga H.R.P. & O. (1.4mm)	
Color Couleur	Asa-61 Grey	Finish Fini Smooth
Description 1500SDC 8.5" x 3.5" x 3" Assembly		Detail Rev.
Part Number Numéro Pièce	1500SDC080302	Rev. 1 0

SEE BILL OF MATERIAL ON LAST PAGE

This drawing is confidential and must not be reproduced or used without the consent of EXM

Ce dessin est confidentiel et ne doit pas être reproduit ou utilisé sans le consentement de EXM

No.	Revisions	Date	By/Par

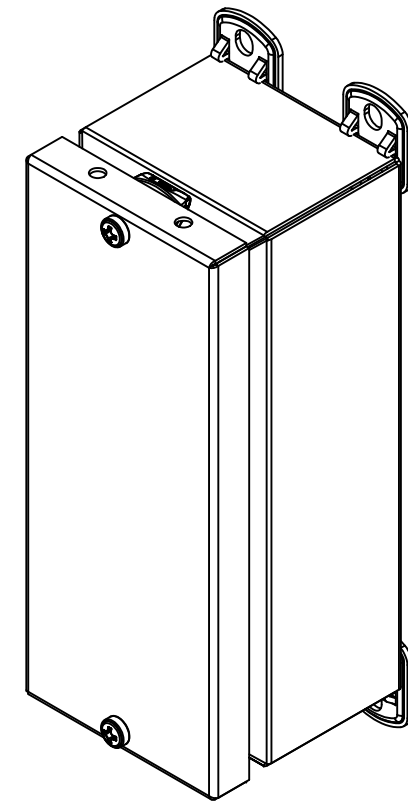

Isometric View

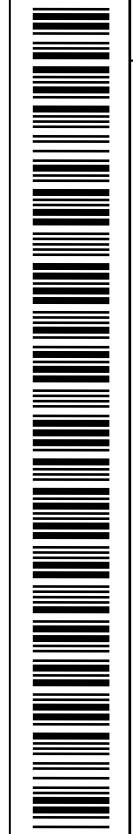

Tél: (450) 979-4373
 Fax: (450) 979-4626
www.exmweb.com

Flatness
Aplatissement
Max 3.0mm
Projection

Customer Client	Date
Drawn By Dessiné Par BoxCad: patsan	Date 06/06/2013
Material Matière 16 Ga H.R.P. & O. (1.4mm)	
Color Couleur Asa-61 Grey	Finish Fini Smooth

Qty	Part Number	Rev	Description
1	1500SDC080302C	0	1500SDC 8.5" x 3.5" Cover
1	STK-K-09500-02	0	Pushbutton Accessory Kit (2 Screws Construction)
1	1500SDC080302B	0	1500SDC 8.5" x 3.5" x 3" Body
Parts List			

Description 1500SDC 8.5" x 3.5" x 3" Assembly		Detail Rev.	
Part Number Numéro Pièce 1500SDC080302		Rev. 0	2 2

This drawing is confidential and must not be reproduced or used without the consent of EXM

Ce dessin est confidentiel et ne doit pas être reproduit ou utilisé sans le consentement de EXM

No.	Revisions	Date	By/Par

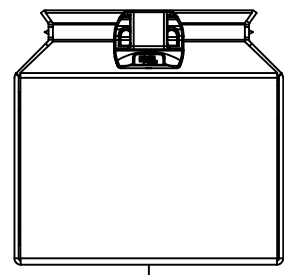

TOP

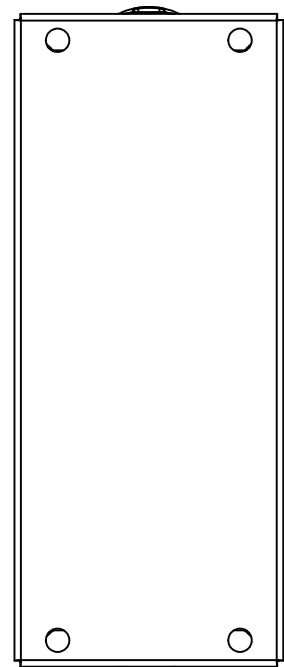

BACK

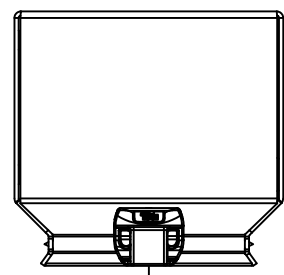

BOTTOM

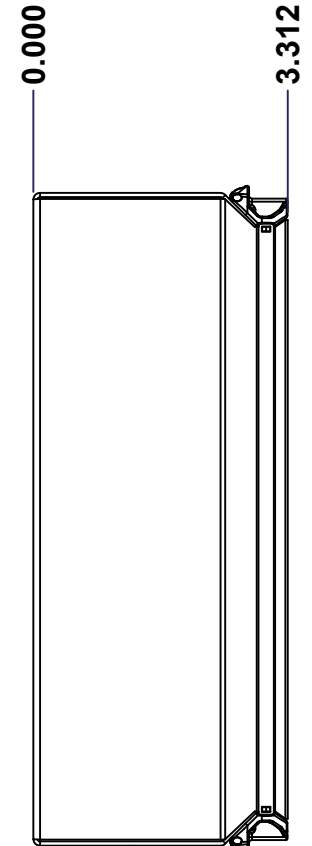

LEFT

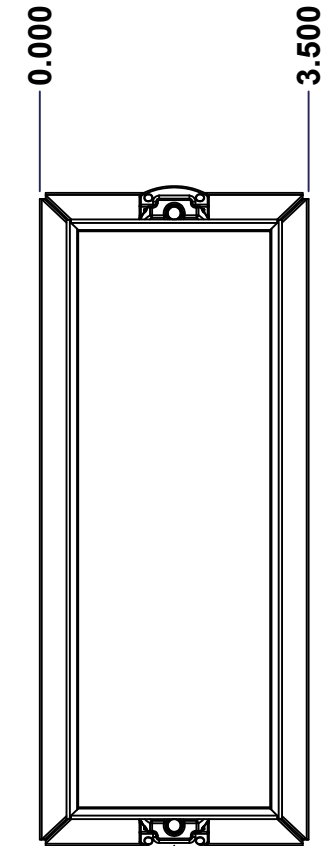

FRONT

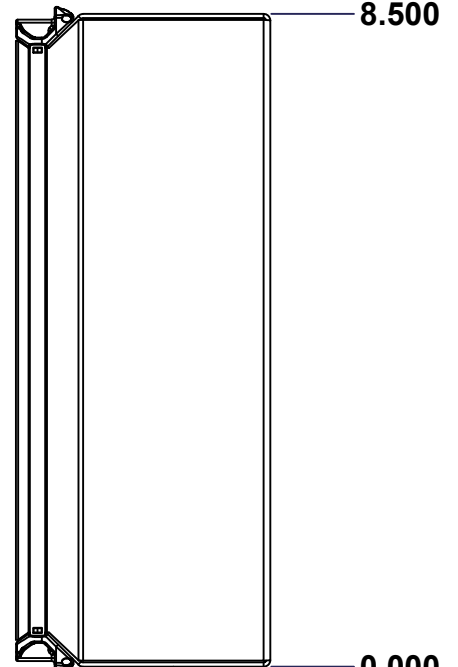

RIGHT

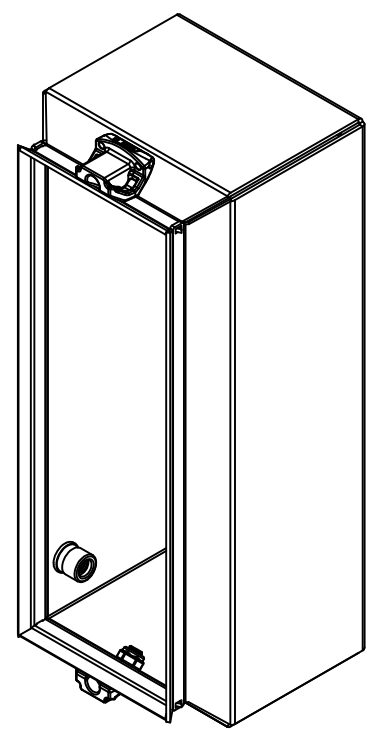

Isometric View

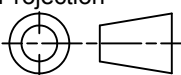

 Tél: (450) 979-4373 Fax: (450) 979-4626 www.exmweb.com		Flatness Aplatissement Max 3.0mm Projection 
Customer Client	Date	
Drawn By Dessiné Par	BoxCad: patsan	Date 06/06/2013
Material Matière	16 Ga H.R.P. & O. (1.4mm)	
Color Couleur	Asa-61 Grey	Finish Fini Smooth
Description	Detail Rev.	
1500SDC 8.5" x 3.5" x 3" Body		
Part Number Numéro Pièce	Rev.	1 7
1500SDC080302B	0	

SEE BILL OF MATERIAL ON LAST PAGE

This drawing is confidential and must not be reproduced or used without the consent of EXM

Ce dessin est confidentiel et ne doit pas être reproduit ou utilisé sans le consentement de EXM

No.	Revisions	Date	By/Par

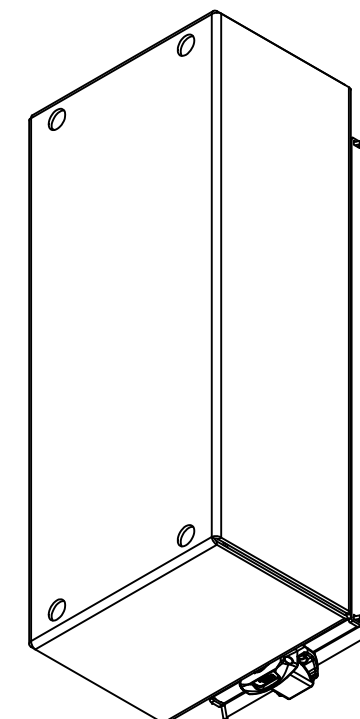

Isometric View

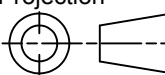

 Tél: (450) 979-4373 Fax: (450) 979-4626 www.exmweb.com		Flatness Aplatissement Max 3.0mm Projection 
Customer Client	Date	
Drawn By Dessiné Par	BoxCad: patsan	Date 06/06/2013
Material Matière	16 Ga H.R.P. & O. (1.4mm)	
Color Couleur	Asa-61 Grey	Finish Fini Smooth
Description		Detail Rev.
1500SDC 8.5" x 3.5" x 3" Body		
Part Number Numéro Pièce	Rev.	7
1500SDC080302B	0	7

Qty	Part Number	Rev	Description
1	STK-P-02400S	0	Powder Paint (Asa-61 Grey / Smooth)
1	STK-S-00100	0.1.1	3.5" x 2" Silver Milar Flexcon Sticker
1	1500SDC080302B-P	0	1500SDC 8.5" x 3.5" x 3" Body Part
1	STK-Q-08350	4	Standoff M6 x 10mm
2	STK-Q-08100	1	M5 Nylon Insert Lock Nut
2	STK-Q-70463	0	5412ESMSC - Zinc Casting Body Catch Screw Cover
Parts List			

This drawing is confidential and must not be reproduced or used without the consent of EXM

Ce dessin est confidentiel et ne doit pas être reproduit ou utilisé sans le consentement de EXM

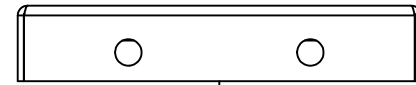

TOP

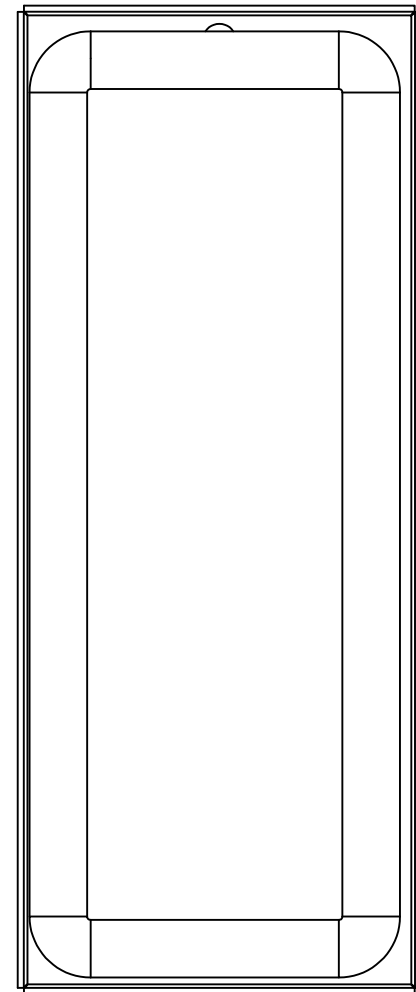

BACK

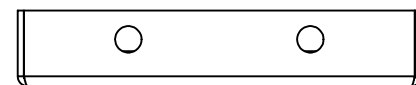

BOTTOM

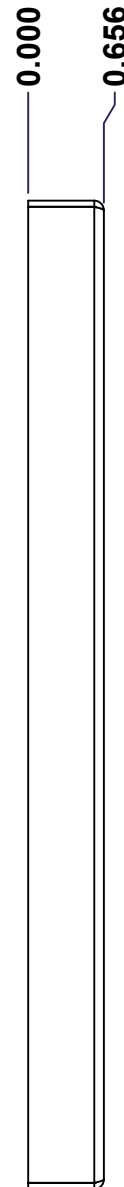

LEFT

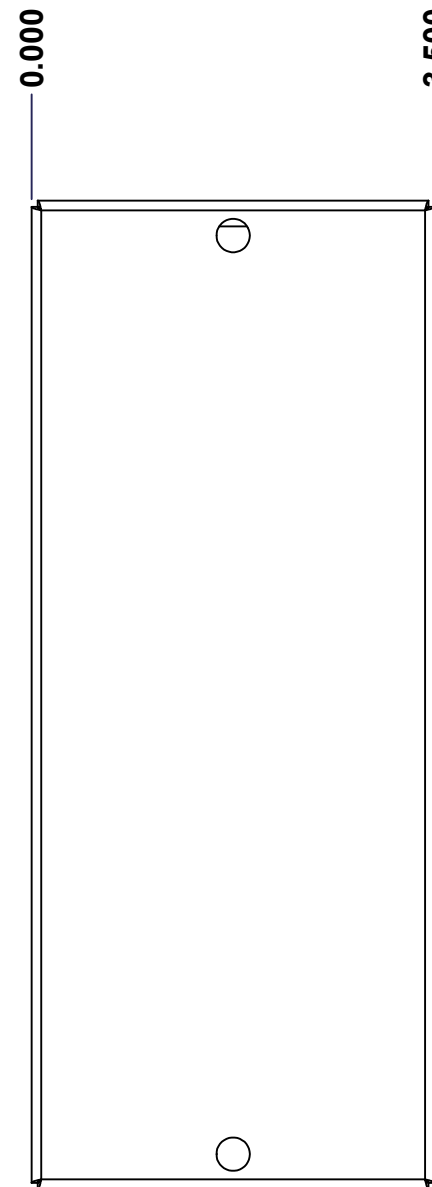

FRONT

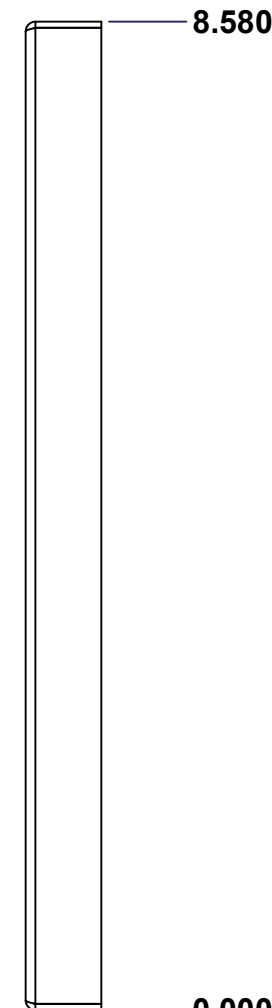

RIGHT

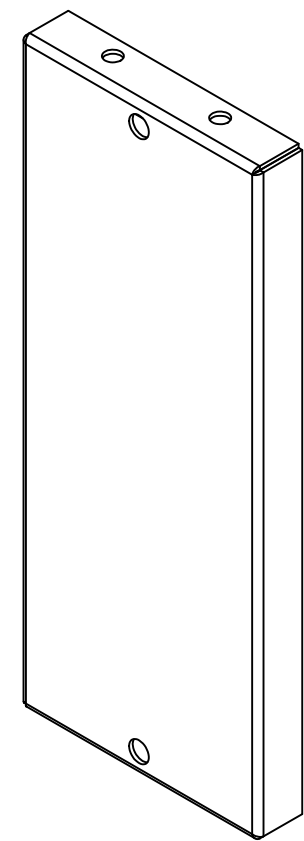

Isometric View

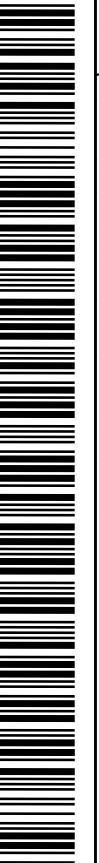

No.	Revisions	Date	By/Par

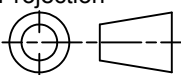
 Tél: (450) 979-4373 Fax: (450) 979-4626 www.exmweb.com		Flatness Aplatissement Max 3.0mm Projection 
Customer Client	Date	
Drawn By Dessiné Par	BoxCad: patsan	Date 06/06/2013
Material Matière	16 Ga H.R.P. & O. (1.4mm)	
Color Couleur	Asa-61 Grey	Finish Fini Smooth
Description	Detail Rev.	
1500SDC 8.5" x 3.5" Cover		
Part Number Numéro Pièce	Rev.	1
1500SDC080302C	0	3

SEE BILL OF MATERIAL ON LAST PAGE

This drawing is confidential and must not be reproduced or used without the consent of EXM

Ce dessin est confidentiel et ne doit pas être reproduit ou utilisé sans le consentement de EXM

No.	Revisions	Date	By/Par

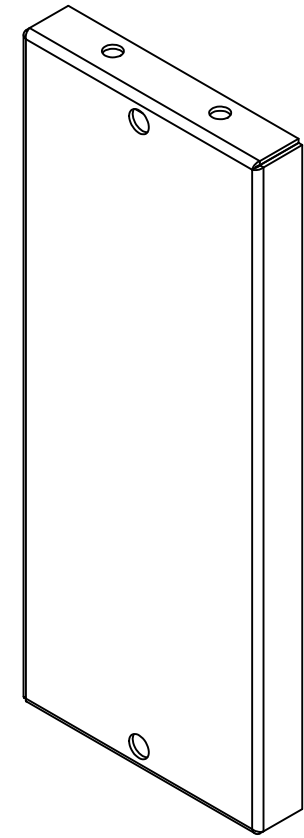

Isometric View

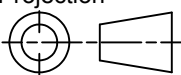

 Tél: (450) 979-4373 Fax: (450) 979-4626 www.exmweb.com		Flatness Aplatissement Max 3.0mm Projection 
Customer Client	Date	
Drawn By Dessiné Par	BoxCad: patsan	Date 06/06/2013
Material Matière	16 Ga H.R.P. & O. (1.4mm)	
Color Couleur	Asa-61 Grey	Finish Fini Smooth
Description		Detail Rev.
1500SDC 8.5" x 3.5" Cover		
Part Number Numéro Pièce	Rev.	3
1500SDC080302C	0	3

Qty	Part Number	Rev	Description
1	STK-P-02400S	0	Powder Paint (Asa-61 Grey / Smooth)
1	1500SDC080302G	0	1500SDC 8.5" x 3.5" Gasket
1	1500SDC080302C-P	0	1500SDC 8.5" x 3.5" Cover Part
Parts List			