

This drawing is confidential and must not be reproduced or used without the consent of EXM

Ce dessin est confidentiel et ne doit pas être reproduit ou utilisé sans le consentement de EXM

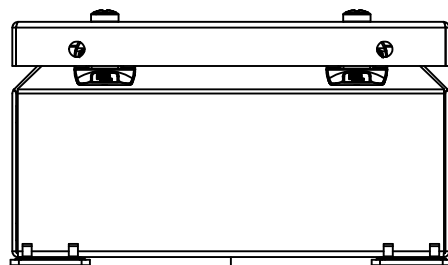

TOP

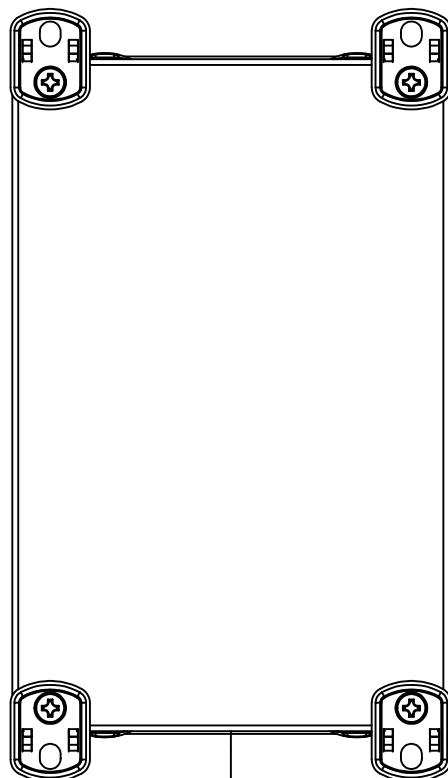

BACK

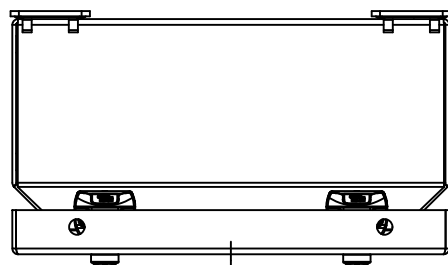

BOTTOM

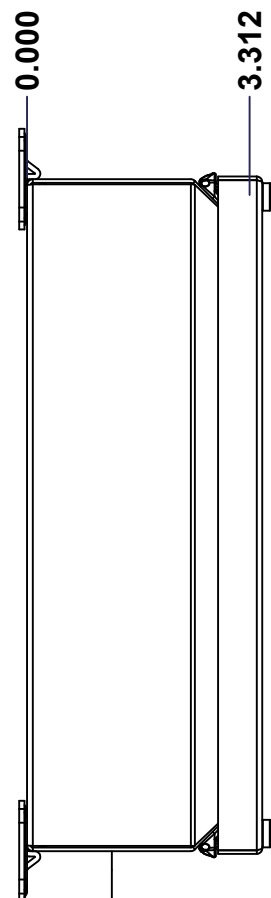

LEFT

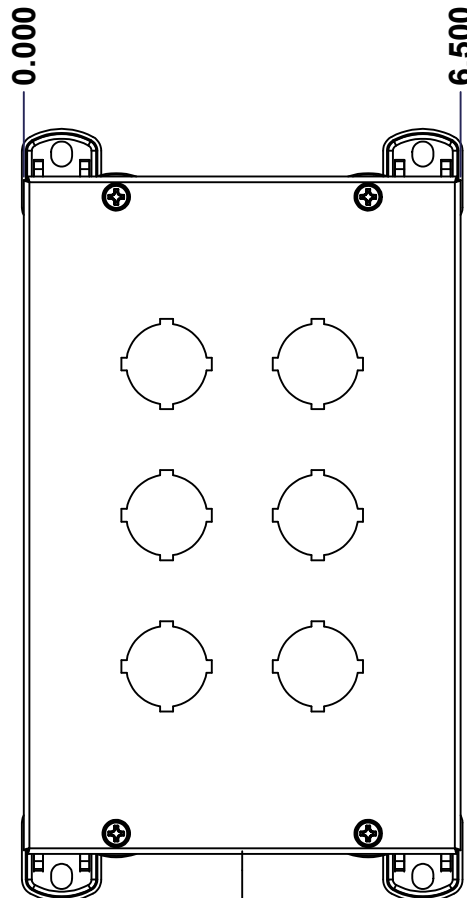

FRONT

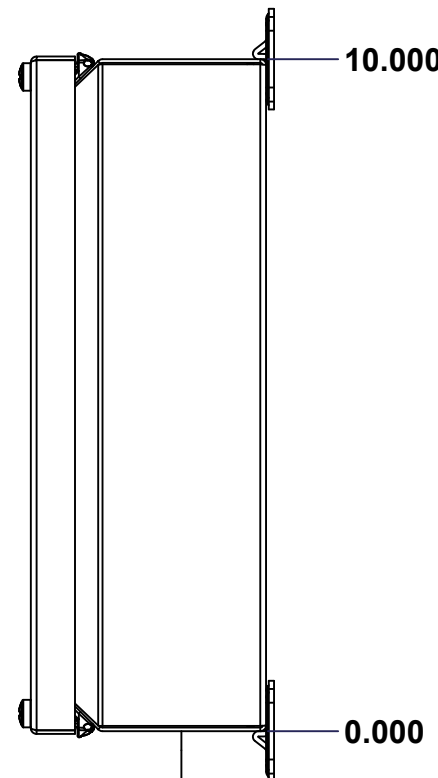

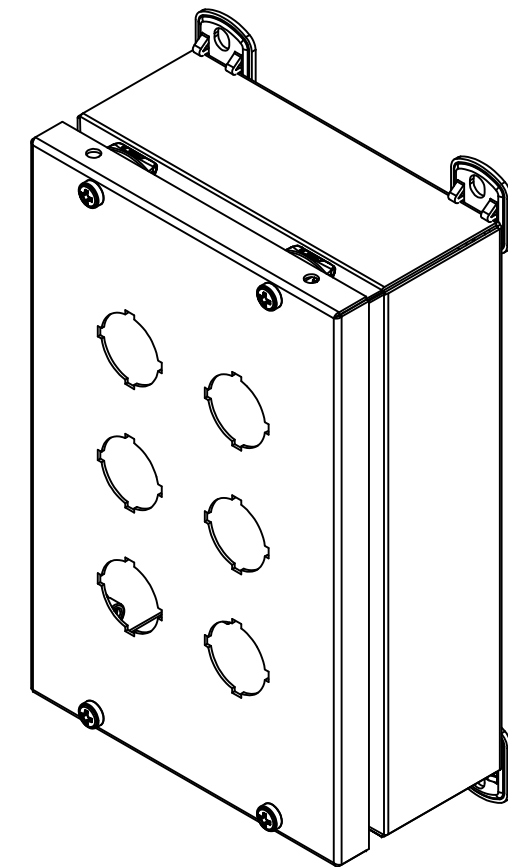

RIGHT

No.	Revisions	Date	By/Par

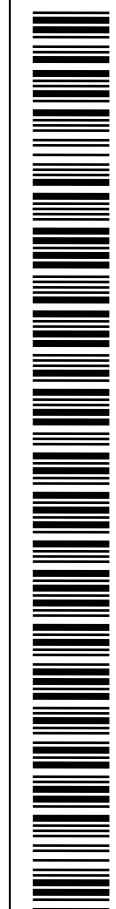

Isometric View



 Tél: (450) 979-4373 Fax: (450) 979-4626 www.exmweb.com		Flatness Aplatissement	
		Max 3.0mm	
Customer Client		Date	
Drawn By Dessiné Par BoxCad: patsan		Date 06/06/2013	
Material Matière 16 Ga Stainless Steel 316 (1.4mm)			
Color Couleur	Outside Unpainted and Inside White RAL9003	Finish Fini	Brushed
Description 1412SDSS6 10" x 6.5" x 3" Assembly			Detail Rev.
Part Number Numéro Pièce 1412SDSS0906036			Rev. 1 0

SEE BILL OF MATERIAL ON LAST PAGE

This drawing is confidential and must not be reproduced or used without the consent of EXM

Ce dessin est confidentiel et ne doit pas être reproduit ou utilisé sans le consentement de EXM

No.	Revisions	Date	By/Par

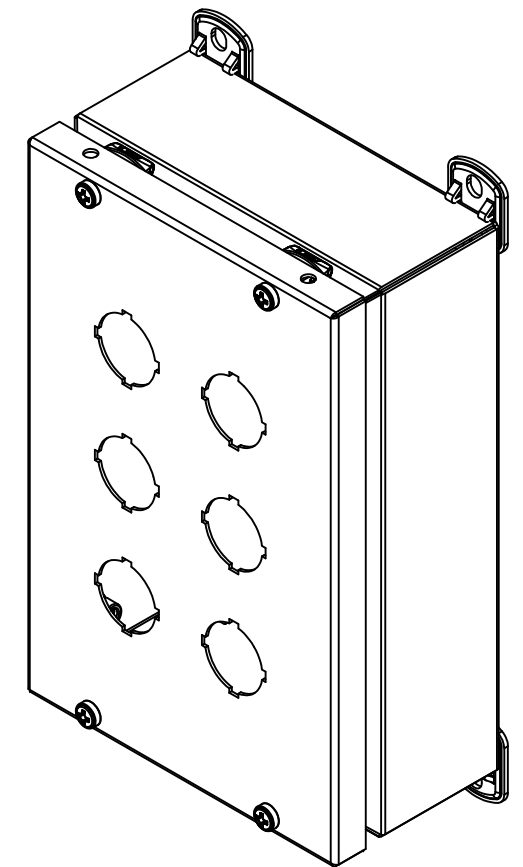

Isometric View



Tél: (450) 979-4373
 Fax: (450) 979-4626
www.exmweb.com

Flatness
Aplatissement
Max 3.0mm
Projection

Customer Client	Date
Drawn By Dessiné Par BoxCad: patsan	Date 06/06/2013
Material Matière 16 Ga Stainless Steel 316 (1.4mm)	
Color Couleur Outside Unpainted and Inside White RAL9003	Finish Fini Brushed

Qty	Part Number	Rev	Description
1	1412SDSS0906036C	0	1412SDSS6 10" x 6.5" Cover
1	STK-K-09600-04	0	Pushbutton Accessory Kit (4 Screws Construction)
1	1412SDSS0906036B	0	1412SDSS6 10" x 6.5" x 3" Body
Parts List			

Description 1412SDSS6 10" x 6.5" x 3" Assembly		Detail Rev.
Part Number Numéro Pièce 1412SDSS0906036	Rev. 0	2 2

This drawing is confidential and must not be reproduced or used without the consent of EXM

Ce dessin est confidentiel et ne doit pas être reproduit ou utilisé sans le consentement de EXM

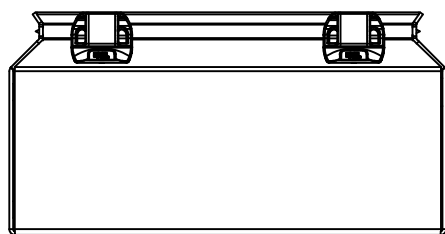

TOP

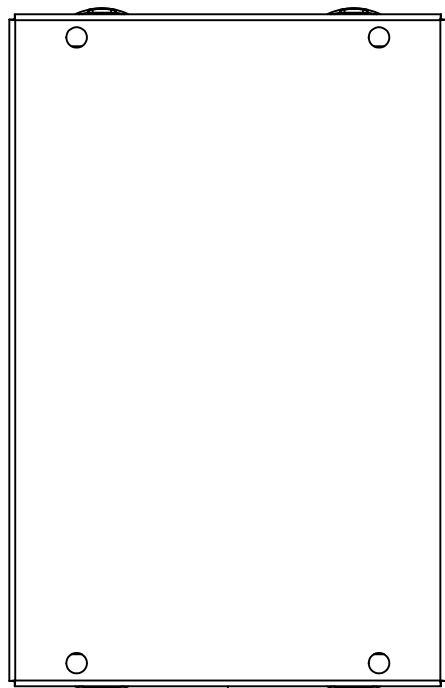

BACK

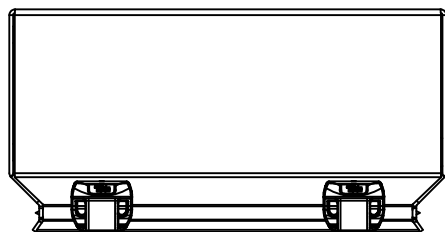

BOTTOM

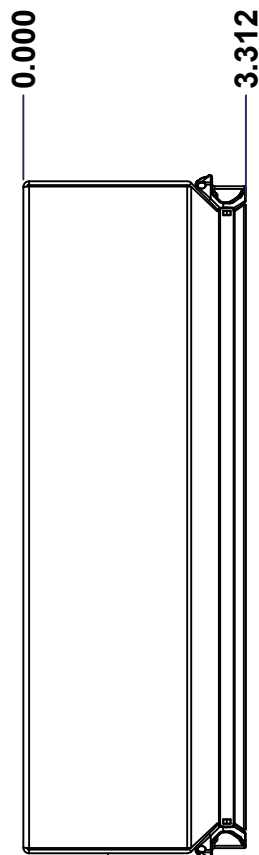

LEFT

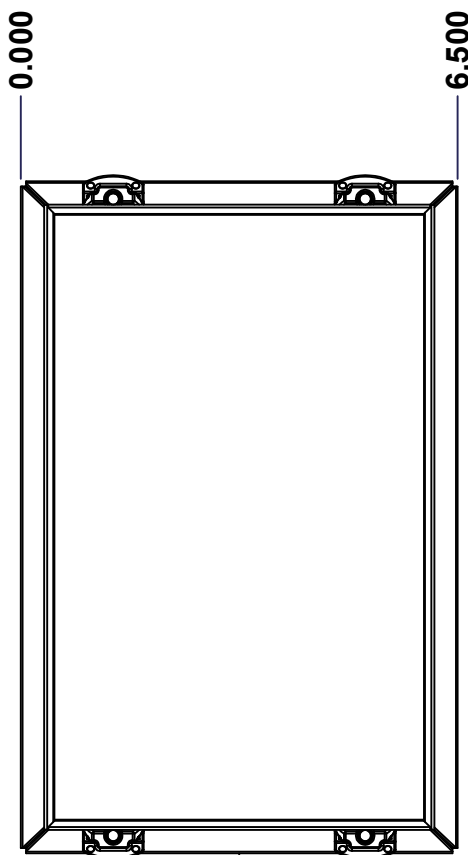

FRONT

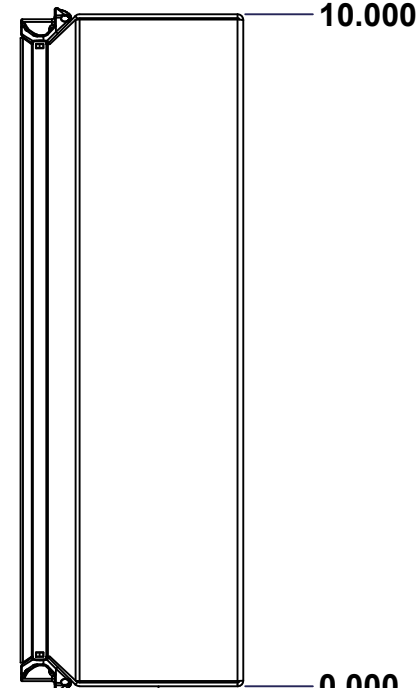

RIGHT

No.	Revisions	Date	By/Par

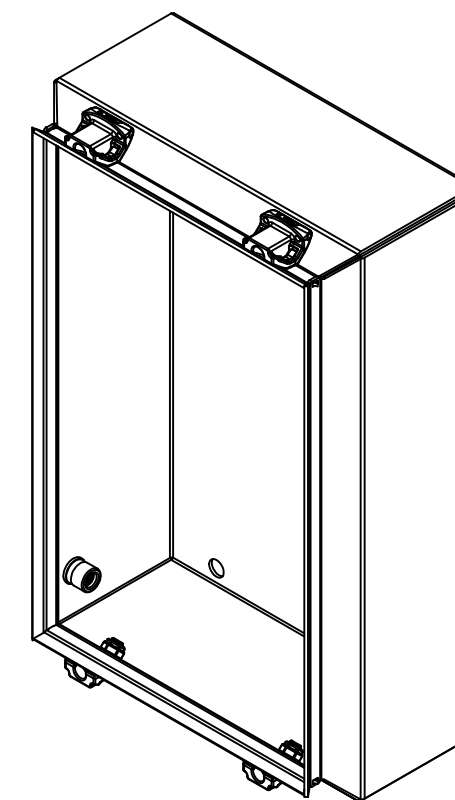

Isometric View



Tél: (450) 979-4373
 Fax: (450) 979-4626
www.exmweb.com

Flatness
Aplatissement

Max 3.0mm

Projection



Customer Client	Date
Drawn By Dessiné Par BoxCad: patsan	Date 06/06/2013
Material Matière 16 Ga Stainless Steel 316 (1.4mm)	
Color Couleur Outside Unpainted and Inside White RAL9003	Finish Fini Brushed
Description 1412SDSS6 10" x 6.5" x 3" Body	Detail Rev.
Part Number Numéro Pièce 1412SDSS0906036B	Rev. 0

SEE BILL OF MATERIAL ON LAST PAGE

1
7

This drawing is confidential and must not be reproduced or used without the consent of EXM

Ce dessin est confidentiel et ne doit pas être reproduit ou utilisé sans le consentement de EXM

No.	Revisions	Date	By/Par

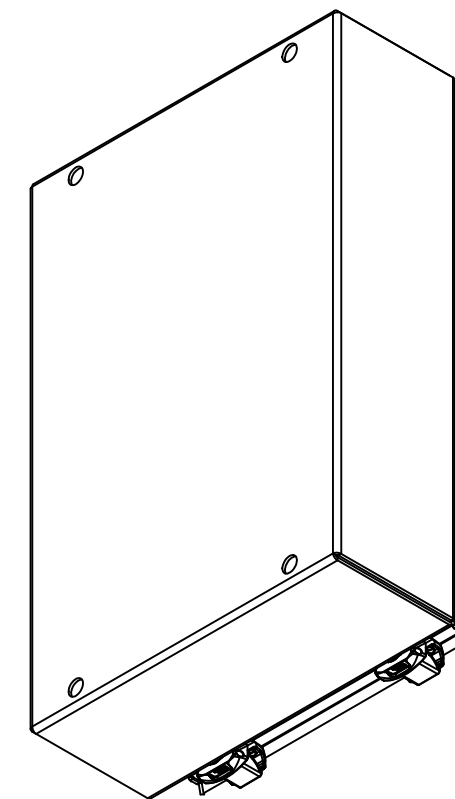

Isometric View



Tél: (450) 979-4373
 Fax: (450) 979-4626
www.exmweb.com

Flatness
Aplatissement

Max 3.0mm

Projection



Customer Client	Date
Drawn By / Dessiné Par: BoxCad: patsan	Date: 06/06/2013
Material / Matière: 16 Ga Stainless Steel 316 (1.4mm)	

Color / Couleur: Outside Unpainted and Inside White RAL9003	Finish / Fini: Brushed
---	------------------------

Description: 1412SDSS6 10" x 6.5" x 3" Body	Detail Rev.
---	-------------

Part Number / Numéro Pièce: 1412SDSS0906036B	Rev. 0	7 / 7
--	--------	-------

Qty	Part Number	Rev	Description
4	STK-Q-70464	0	5412ESSMSC - Stainless Steel Body Catch Screw Cover
1	STK-P-02401S	0	Powder Paint (White / Smooth)
1	STK-S-00100	0.1.1	3.5" x 2" Silver Milar Flexcon Sticker
1	1412SDSS0906036B-P	0	1412SDSS6 10" x 6.5" x 3" Body Part
1	STK-Q-08500	4	Stainless Steel Standoff M6 x 10mm
4	STK-Q-08100	1	M5 Nylon Insert Lock Nut
Parts List			

This drawing is confidential and must not be reproduced or used without the consent of EXM

Ce dessin est confidentiel et ne doit pas être reproduit ou utilisé sans le consentement de EXM

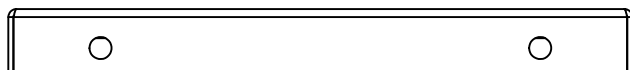

TOP

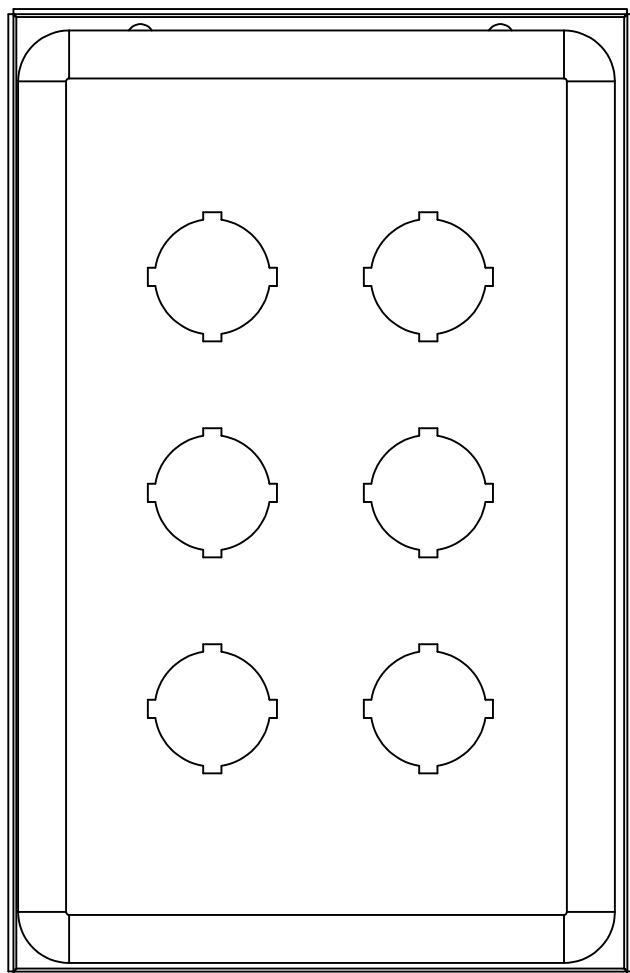

BACK

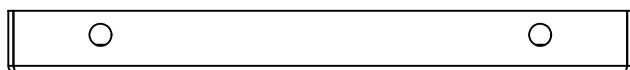

BOTTOM

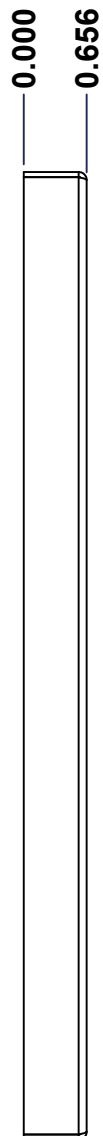

LEFT

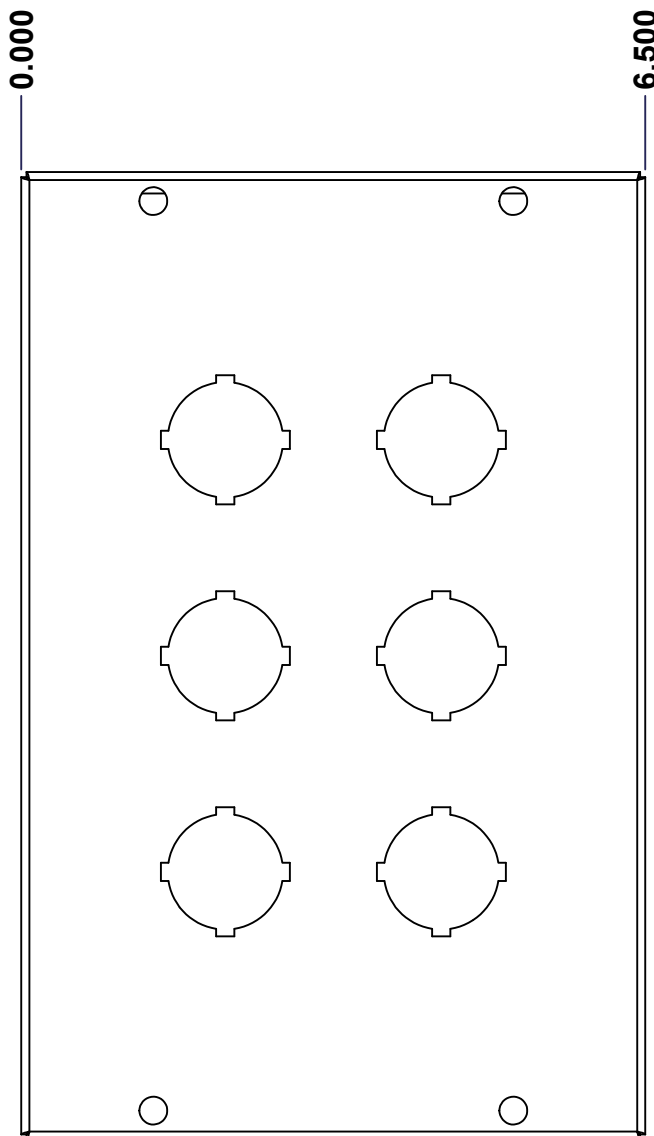

FRONT

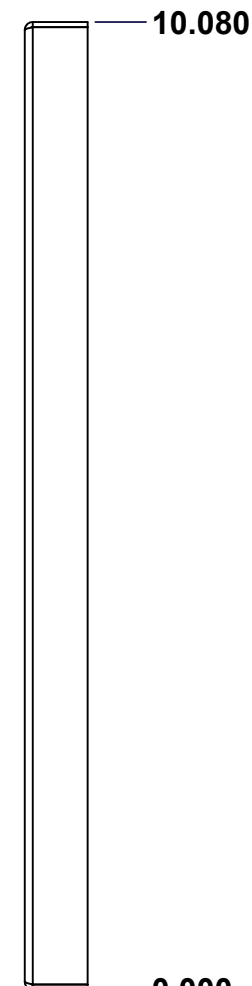

RIGHT

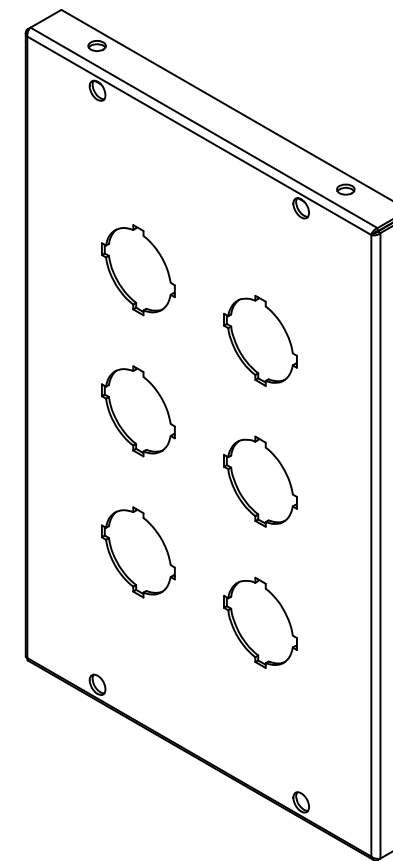

Isometric View

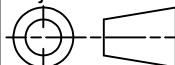

No.	Revisions	Date	By/Par

 Tél: (450) 979-4373 Fax: (450) 979-4626 www.exmweb.com		Flatness Aplatissement Max 3.0mm Projection 
Customer Client	Date	
Drawn By Dessiné Par	BoxCad: patsan	Date 06/06/2013
Material Matière	16 Ga Stainless Steel 316 (1.4mm)	
Color Couleur	Outside Unpainted and Inside White RAL9003	Finish Fini Brushed
Description	Detail Rev.	
1412SDSS6 10" x 6.5" Cover		
Part Number Numéro Pièce	Rev.	1
1412SDSS0906036C	0	3

SEE BILL OF MATERIAL ON LAST PAGE

This drawing is confidential and must not be reproduced or used without the consent of EXM

Ce dessin est confidentiel et ne doit pas être reproduit ou utilisé sans le consentement de EXM

No.	Revisions	Date	By/Par

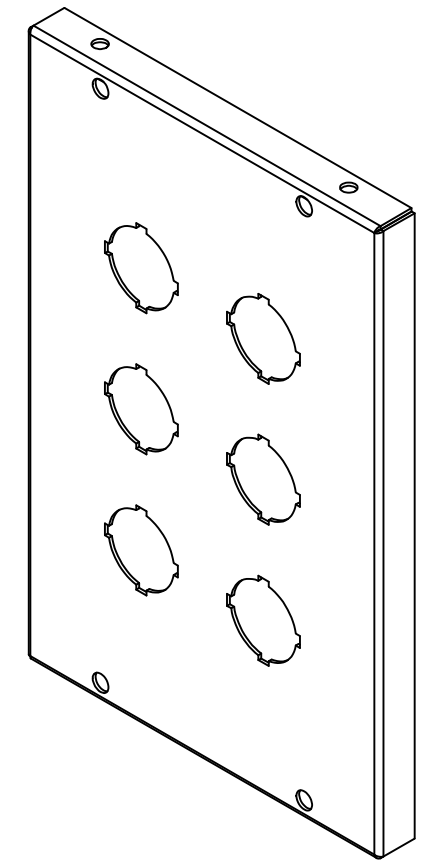

Isometric View

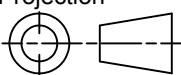

 Tél: (450) 979-4373 Fax: (450) 979-4626 www.exmweb.com		Flatness Aplatissement Max 3.0mm Projection 
Customer Client	Date	
Drawn By Dessiné Par	BoxCad: patsan	Date 06/06/2013
Material Matière	16 Ga Stainless Steel 316 (1.4mm)	
Color Couleur	Outside Unpainted and Inside White RAL9003	Finish Fini Brushed
Description		Detail Rev.
1412SDSS6 10" x 6.5" Cover		
Part Number Numéro Pièce	Rev.	3
1412SDSS0906036C	0	3

Qty	Part Number	Rev	Description
1	STK-P-02401S	0	Powder Paint (White / Smooth)
1	1412SDSS0906036G	0	1412SDSS6 10" x 6.5" Gasket
1	1412SDSS0906036C-P	0	1412SDSS6 10" x 6.5" Cover Part
Parts List			