

This drawing is confidential and must not be reproduced or used without the consent of EXM

Ce dessin est confidentiel et ne doit pas être reproduit ou utilisé sans le consentement de EXM

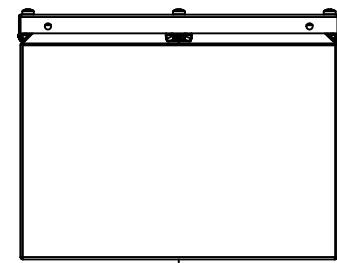

TOP

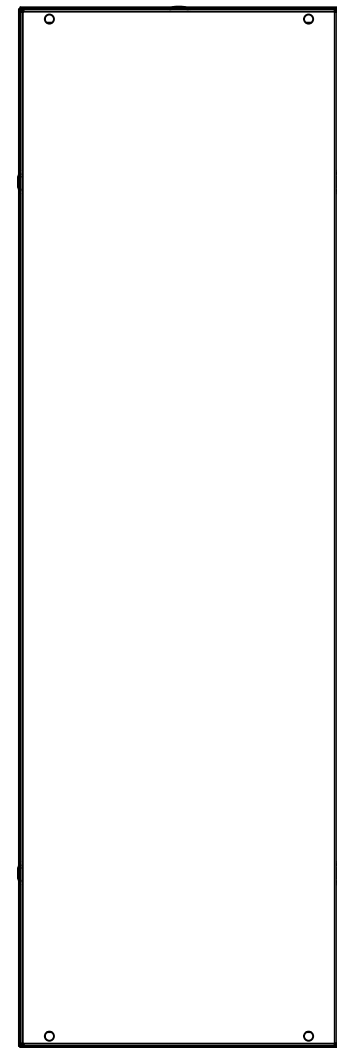

BACK

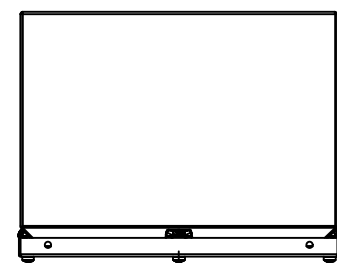

BOTTOM

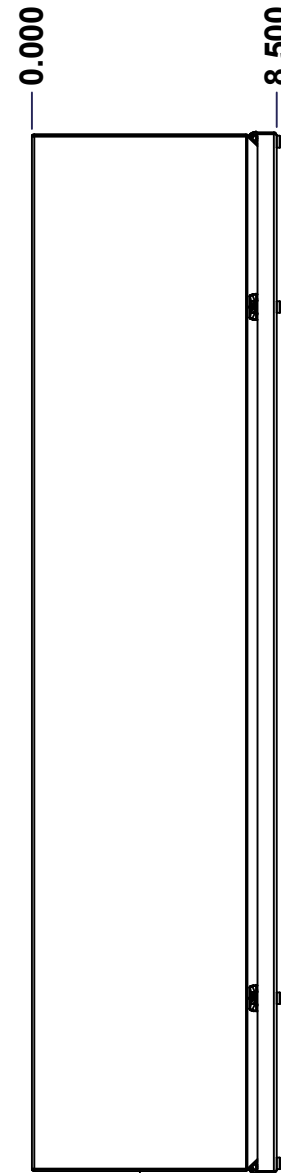

LEFT

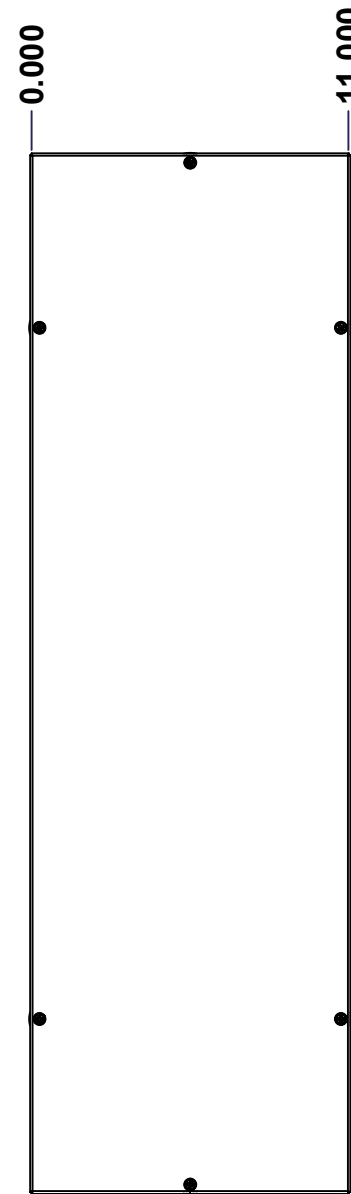

FRONT

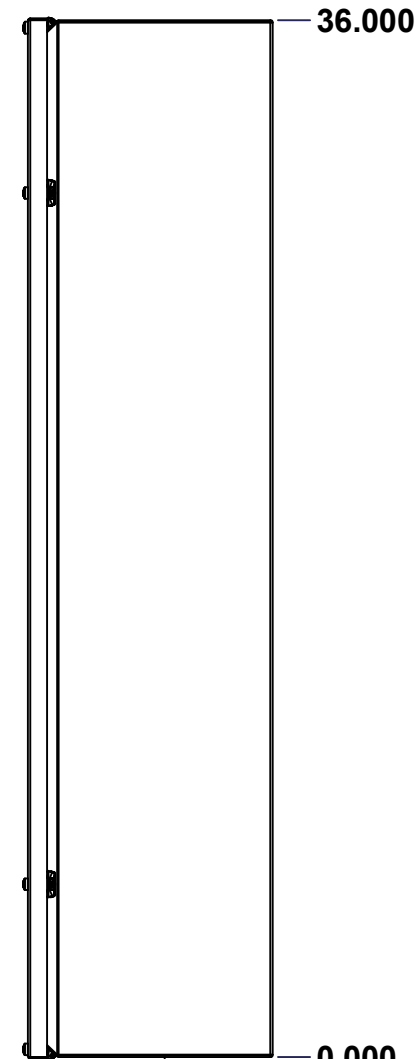

RIGHT

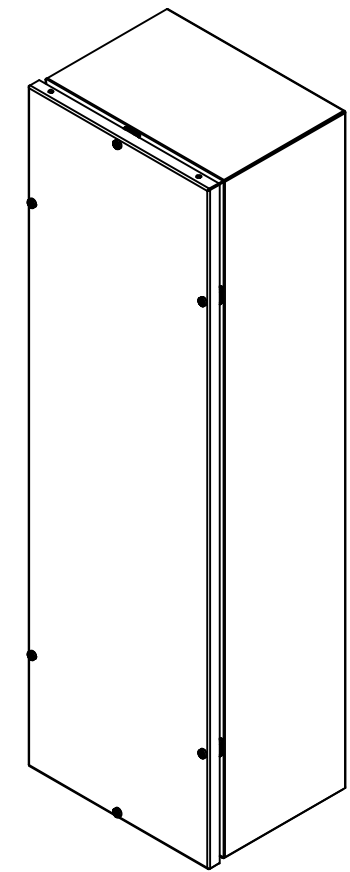
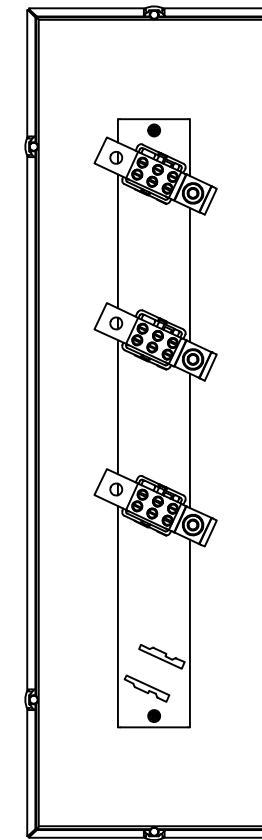

Isometric View

No.	Revisions	Date	By/Par

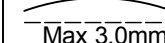
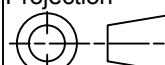

 Tél: (450) 979-4373 Fax: (450) 979-4626 www.exmweb.com		Flatness Aplatissement  Max 3.0mm Projection 
Customer Client		Date
Drawn By Dessiné Par	BoxCad: m_altork	Date 16/02/2015
Material Matière	16 Ga H.R.P. & O. (1.4mm)	
Color Couleur	ASA-61	Finish Fini Smooth
Description 1400T3403 - 3 Wire Assembly		Detail Rev.
Part Number Numéro Pièce	1400T3403	Rev. 1 0 / 2

This drawing is confidential and must not be reproduced or used without the consent of EXM

Ce dessin est confidentiel et ne doit pas être reproduit ou utilisé sans le consentement de EXM

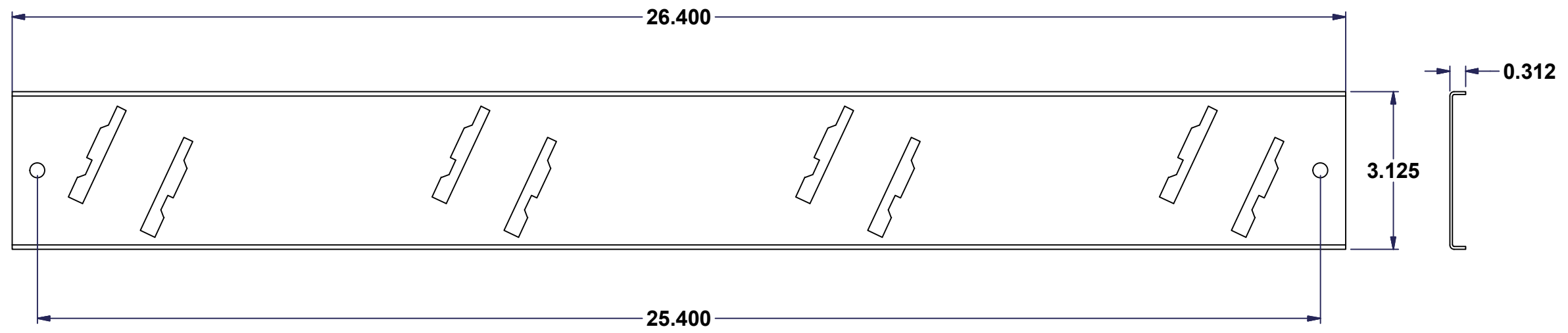

No.	Revisions	Date	By/Par
1	Cut-out was rectangle	10-Jan-07	Patrick
2	Change cut-out angle	17-Jan-07	Patrick

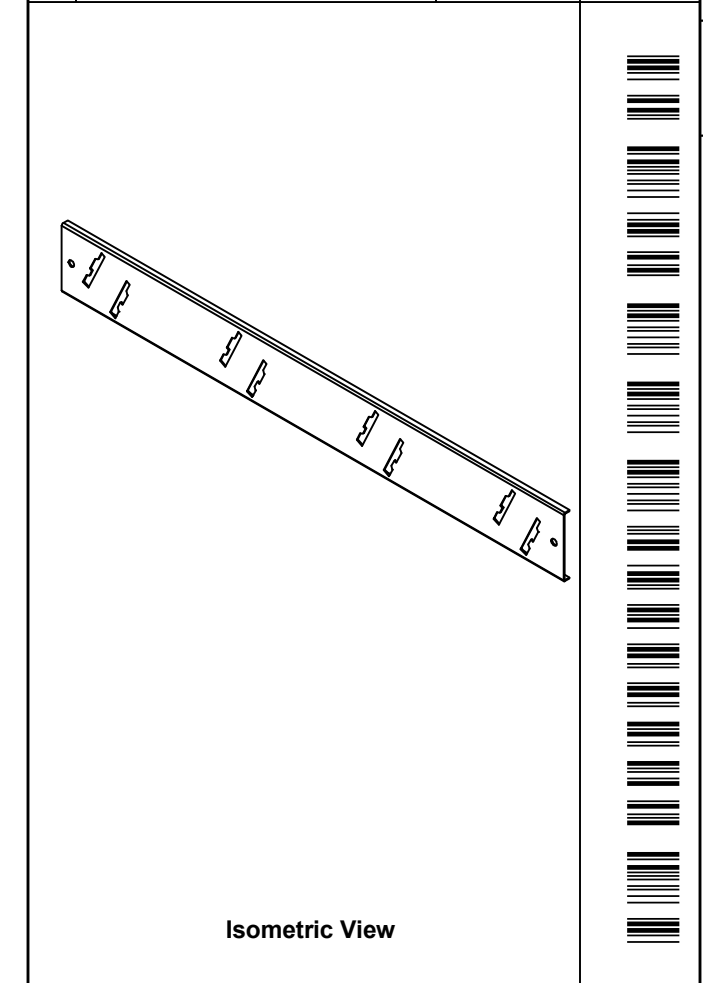

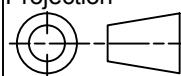
 Tél: (450) 979-4373 Fax: (450) 979-4626 www.exmweb.com		Flatness Aplatissement Max 3.0mm Projection 
Customer Client	Date	
Drawn By Dessiné Par	BoxCad: Patrick Deschenes	Date
Material Matière	16 Ga H.R.P. & O. (1.4mm)	
Color Couleur	Asa-61 Grey	Finish Fini Smooth
Description 1400 T3xxxIP - Inner Panel		Detail Rev.
Part Number Numéro Pièce	1400 T3xxxIP	Rev. 2 2