

This drawing is confidential and must not be reproduced or used without the consent of EXM

Ce dessin est confidentiel et ne doit pas être reproduit ou utilisé sans le consentement de EXM

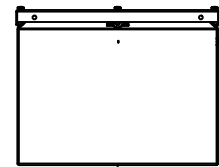

TOP

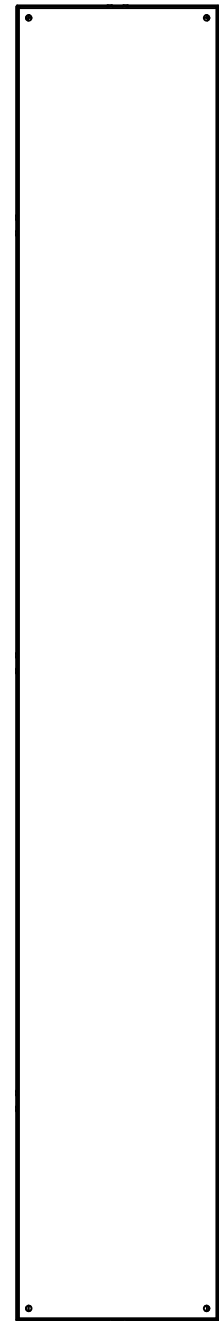

BACK

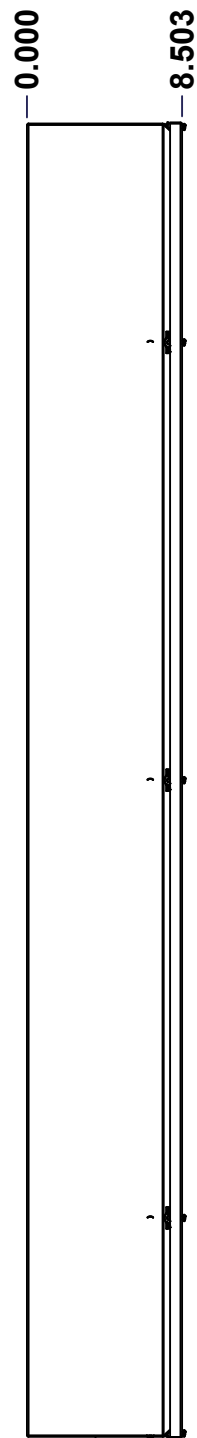
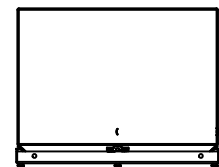

LEFT

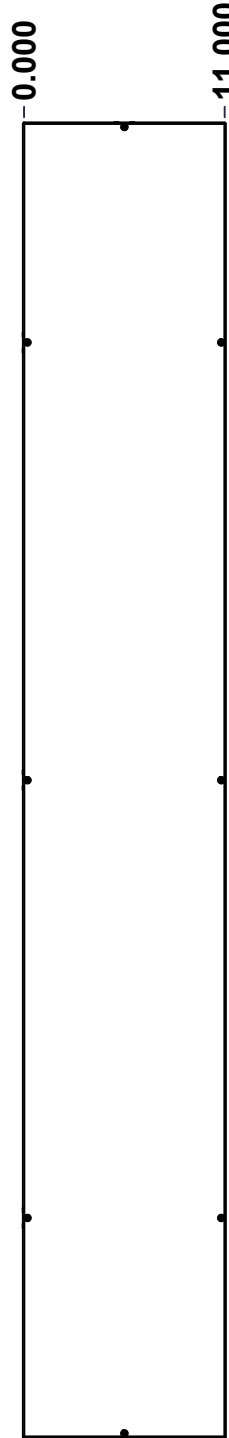

FRONT

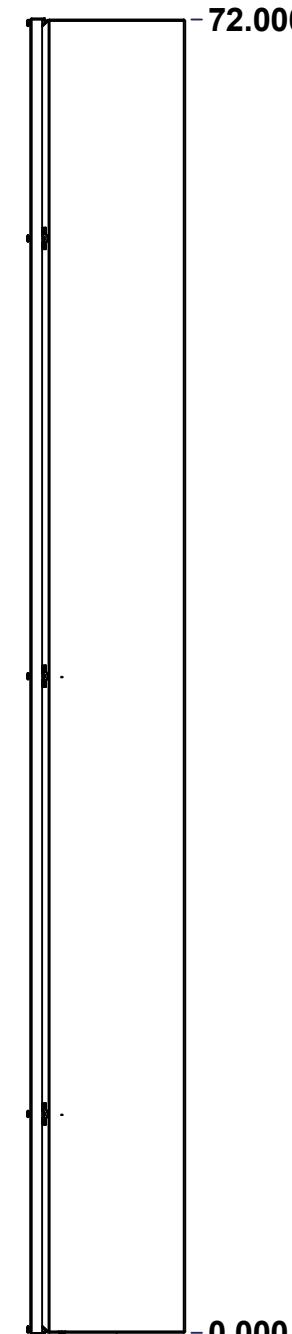

RIGHT

APPROVED FOR PRODUCTION
APPROUVÉ POUR PRODUCTION
 SIGNATURE: _____
 NAME / NOM: _____
 DATE: _____
 Please visit: www.boxcadexm.com

No.	Revisions	Date	By/Par

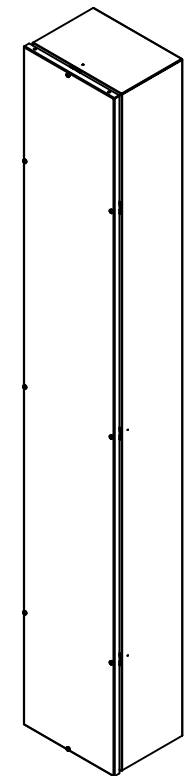

Isometric View

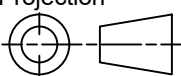

 Tél: (450) 979-4373 Fax: (450) 979-4626 www.exmweb.com	Flatness Aplatissement Max 3.0mm
	Projection 
Customer Client	Date
Drawn By Dessiné Par BoxCad: ArthurC	Date 20-Oct-20
Material Matière 16 Ga H.R.P. & O. (1.4mm)	
Color Couleur Asa-61 Grey	Finish Fini Smooth
Description 1412T6604 Assembly	Detail Rev.
Part Number Numéro Pièce 1412T6604	Rev. 0

1
5

This drawing is confidential and must not be reproduced or used without the consent of EXM

Ce dessin est confidentiel et ne doit pas être reproduit ou utilisé sans le consentement de EXM

NOTE	
ITEM	DESCRIPTION
1	NEMA/EEMAC 3R-4-12 Enclosure
2	C/W Standard ground standoffs on box and cover
3	W/O Standard door stiffener
4	C/W Inner panel
5	C/W Inner panel mounting standoffs

APPROVED FOR PRODUCTION
APPROUVÉ POUR PRODUCTION
 SIGNATURE: _____
 NAME / NOM: _____
 DATE: _____
 Please visit: www.boxcadexm.com

No.	Revisions	Date	By/Par

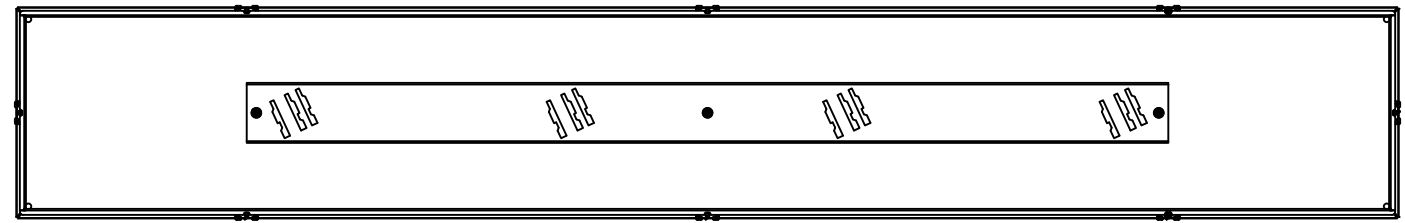

View Without Cover

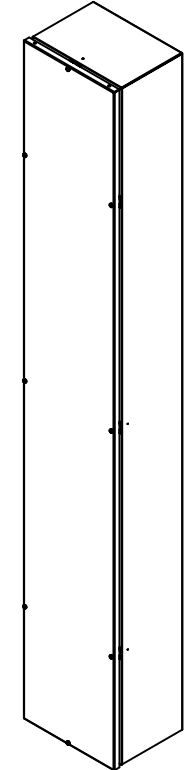

Isometric View

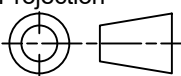

Qty	Part Number	Rev.	Description
1	STK-K-02910	3	5412 ESCH Accessory Kit
3	STK-Q-03200	0	M6 x 8mm Hexagon/Slot Screw
1	1412T6604IP	0	1412T6604 Inner Panel
8	STK-Q-03030	3.1	Phillips Oval Head Screw M5 x 18.5 (Pitch 0.8mm)
8	DEV-Q-77280	4	5412 ESSC M5 Countersink Insert (Flat Hole)
1	1412T6604C	0	1412T6604 Cover
1	1412T6604B	0	1412T6604 Body
Parts List			

 Tél: (450) 979-4373 Fax: (450) 979-4626 www.exmweb.com		Flatness Aplatissement Max 3.0mm Projection 
Customer Client	Date	
Drawn By Dessiné Par	BoxCad: ArthurC	Date 20-Oct-20
Material Matière	16 Ga H.R.P. & O. (1.4mm)	
Color Couleur	Asa-61 Grey	Finish Fini Smooth
Description		Detail Rev.
1412T6604 Assembly		
Part Number Numéro Pièce	1412T6604	Rev. 2 0 5

This drawing is confidential and must not be reproduced or used without the consent of EXM

Ce dessin est confidentiel et ne doit pas être reproduit ou utilisé sans le consentement de EXM

APPROVED FOR PRODUCTION
APPROUVÉ POUR PRODUCTION
 SIGNATURE: _____
 NAME / NOM: _____
 DATE: _____
 Please visit: www.boxcadexm.com

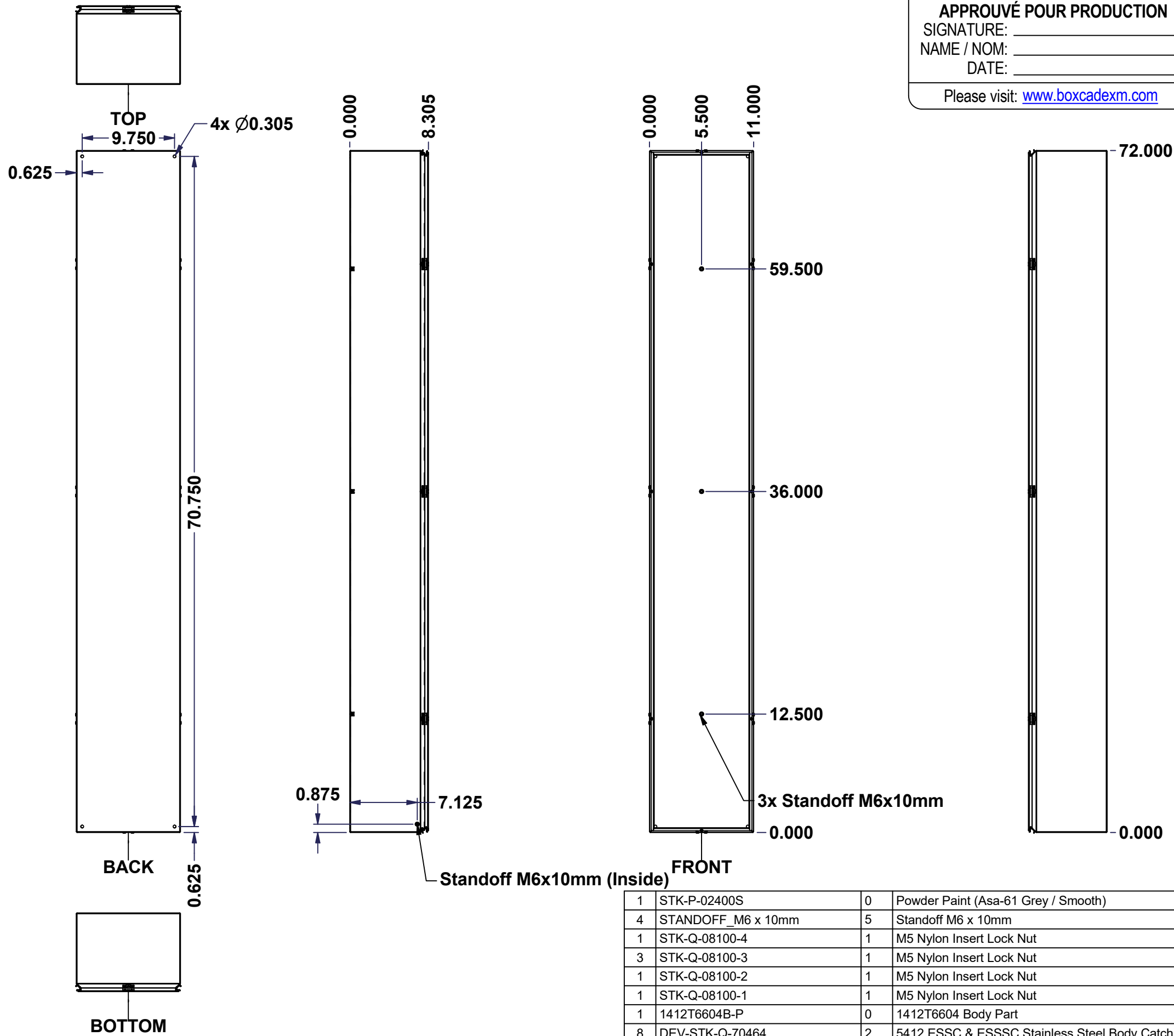

No.	Revisions	Date	By/Par

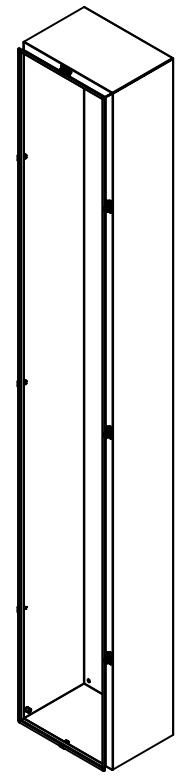

Isometric View

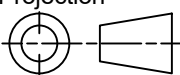

 Tél: (450) 979-4373 Fax: (450) 979-4626 www.exmweb.com		Flatness Aplatissement Max 3.0mm Projection 
Customer Client	Date	
Drawn By Dessiné Par	BoxCad: ArthurC	Date 20-Oct-20
Material Matière	16 Ga H.R.P. & O. (1.4mm)	
Color Couleur	Asa-61 Grey	Finish Fini Smooth
Description	Detail Rev.	
1412T6604 Body		
Part Number Numéro Pièce	Rev.	3
1412T6604B	0	5

Qty	Part Number	Rev.	Description
1	STK-P-02400S	0	Powder Paint (Asa-61 Grey / Smooth)
4	STANDOFF_M6 x 10mm	5	Standoff M6 x 10mm
1	STK-Q-08100-4	1	M5 Nylon Insert Lock Nut
3	STK-Q-08100-3	1	M5 Nylon Insert Lock Nut
1	STK-Q-08100-2	1	M5 Nylon Insert Lock Nut
1	STK-Q-08100-1	1	M5 Nylon Insert Lock Nut
1	1412T6604B-P	0	1412T6604 Body Part
8	DEV-STK-Q-70464	2	5412 ESSC & ESSC Stainless Steel Body Catch Assembly
Parts List			

This drawing is confidential and must not be reproduced or used without the consent of EXM

Ce dessin est confidentiel et ne doit pas être reproduit ou utilisé sans le consentement de EXM

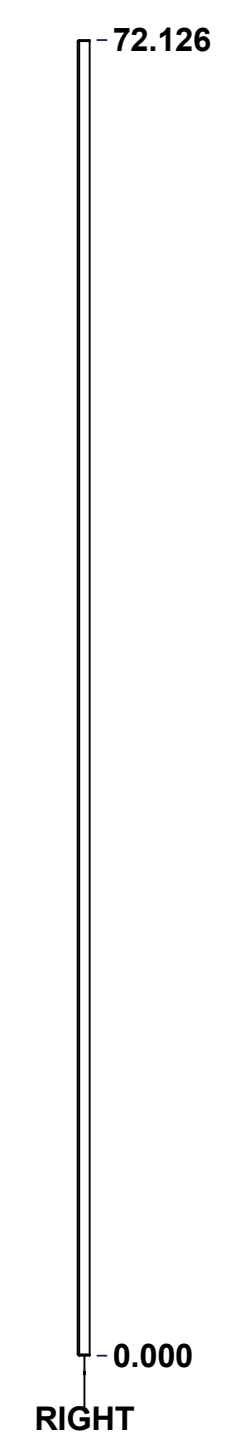
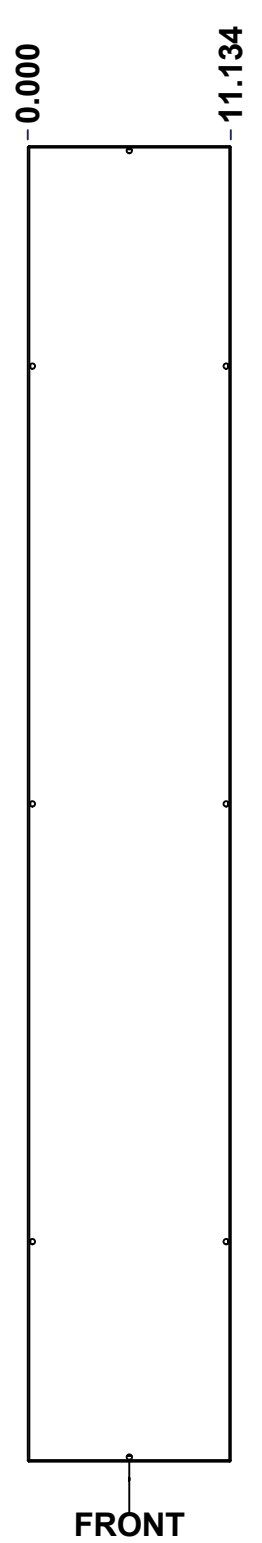
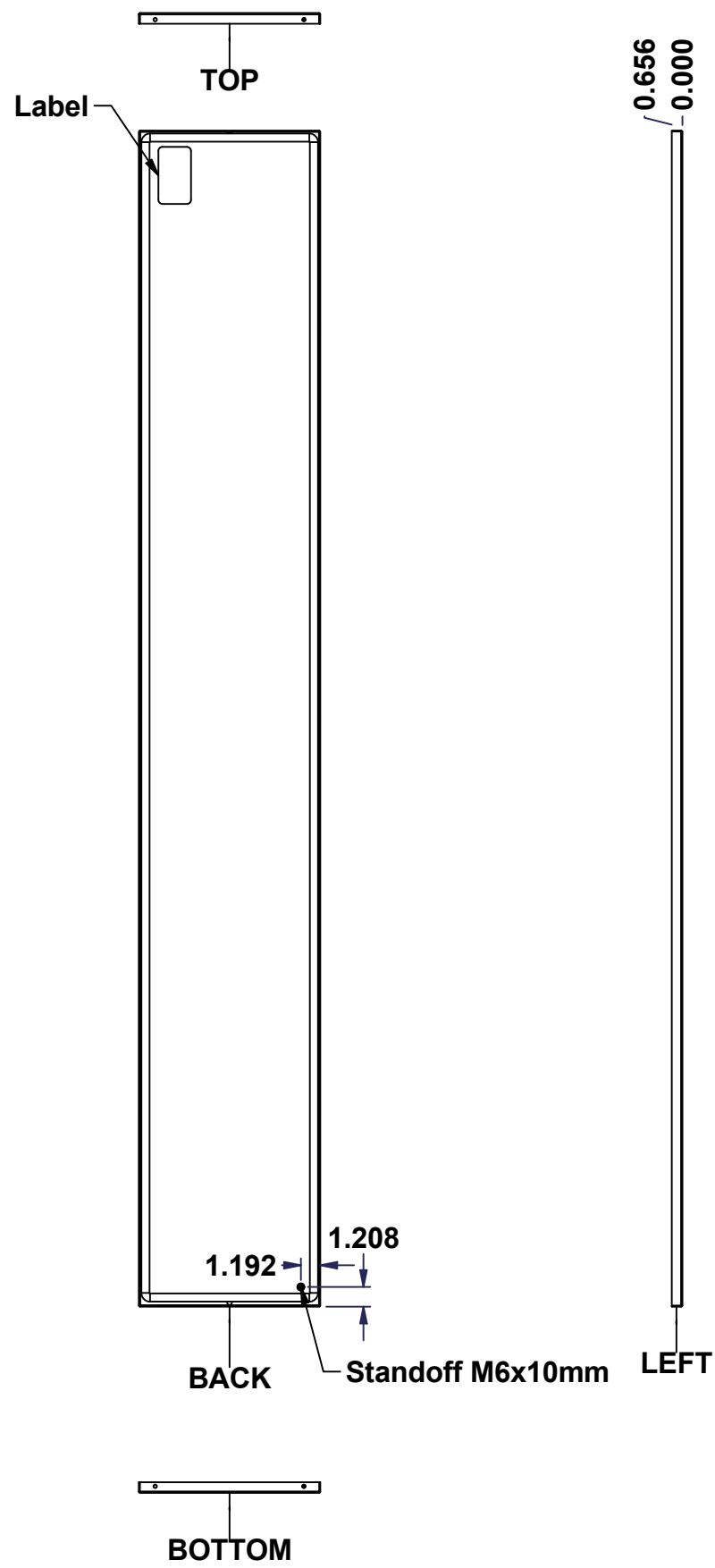

APPROVED FOR PRODUCTION
APPROUVÉ POUR PRODUCTION
 SIGNATURE: _____
 NAME / NOM: _____
 DATE: _____
 Please visit: www.boxcadexm.com

No.	Revisions	Date	By/Par

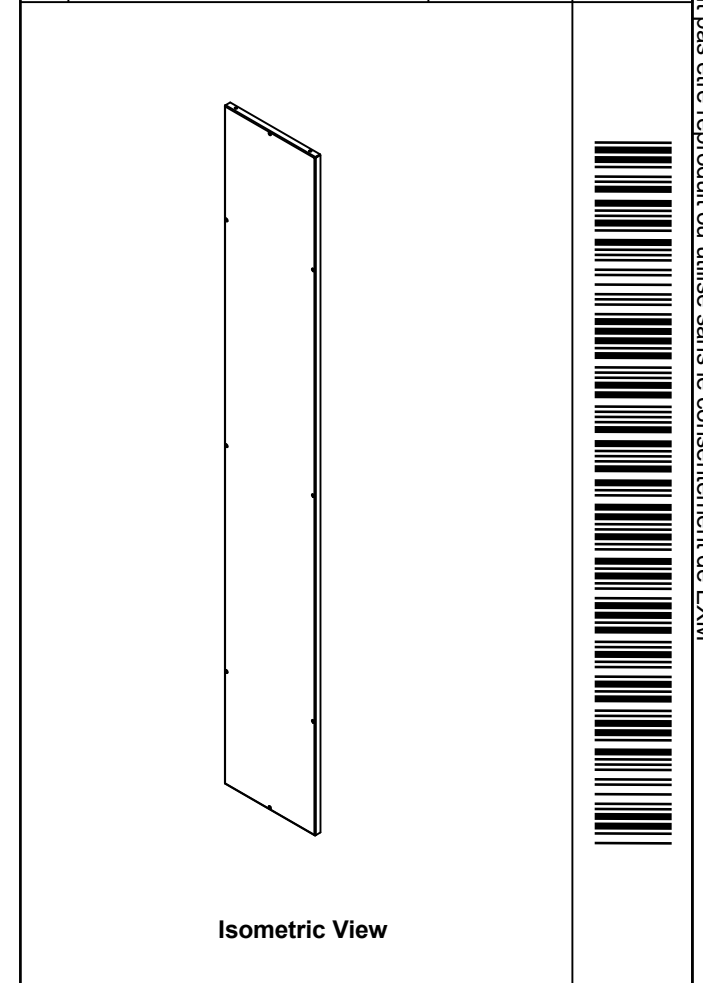

Tél: (450) 979-4373 Fax: (450) 979-4626 www.exmweb.com	Flatness Aplatissement	Max 3.0mm
	Projection	
Customer Client	Date	
Drawn By Dessiné Par	BoxCad: ArthurC	Date 20-Oct-20
Material Matière	16 Ga H.R.P. & O. (1.4mm)	
Color Couleur	Asa-61 Grey	Finish Fini Smooth
Description	1412T6604 Cover	
Part Number Numéro Pièce	1412T6604C	Rev. 4 0 5

Qty	Part Number	Rev.	Description
1	STK-P-02400S	0	Powder Paint (Asa-61 Grey / Smooth)
1	STK-S-00100	0	3.5" x 2" Silver Milar Flexcon Sticker
1	STANDOFF_M6 x 10mm	5	Standoff M6 x 10mm
1	1412T6604G	0	1412T6604 Gasket
1	1412T6604C-P	0	1412T6604 Cover Part

Parts List

This drawing is confidential and must not be reproduced or used without the consent of EXM

Ce dessin est confidentiel et ne doit pas être reproduit ou utilisé sans le consentement de EXM

APPROVED FOR PRODUCTION
APPROUVÉ POUR PRODUCTION
 SIGNATURE: _____
 NAME / NOM: _____
 DATE: _____
 Please visit: www.boxcadexm.com

No.	Revisions	Date	By/Par

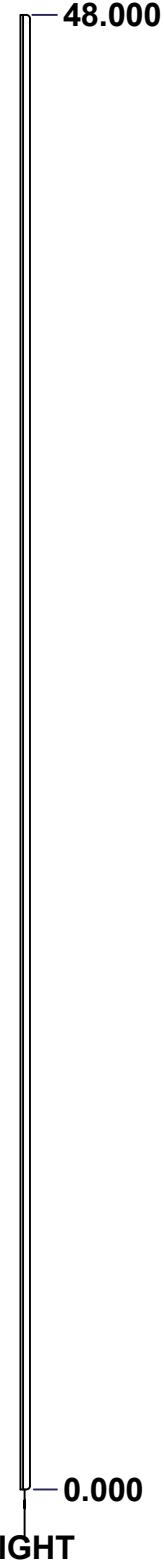
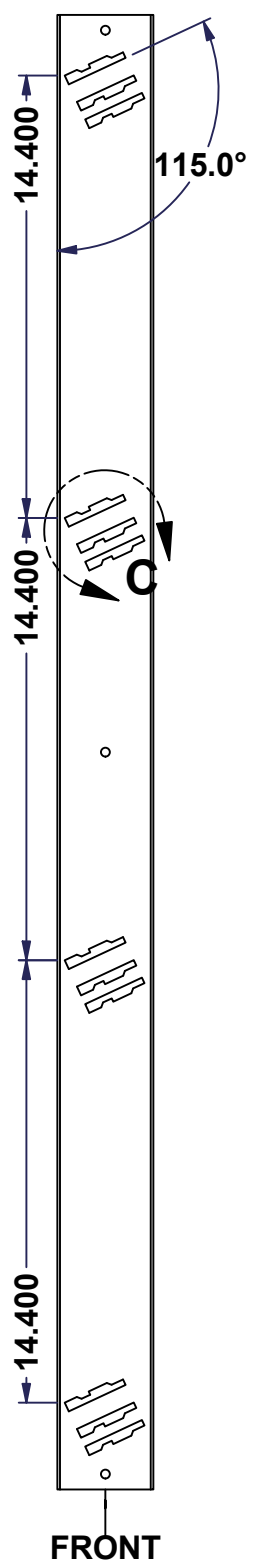
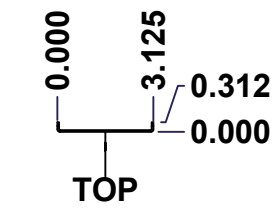
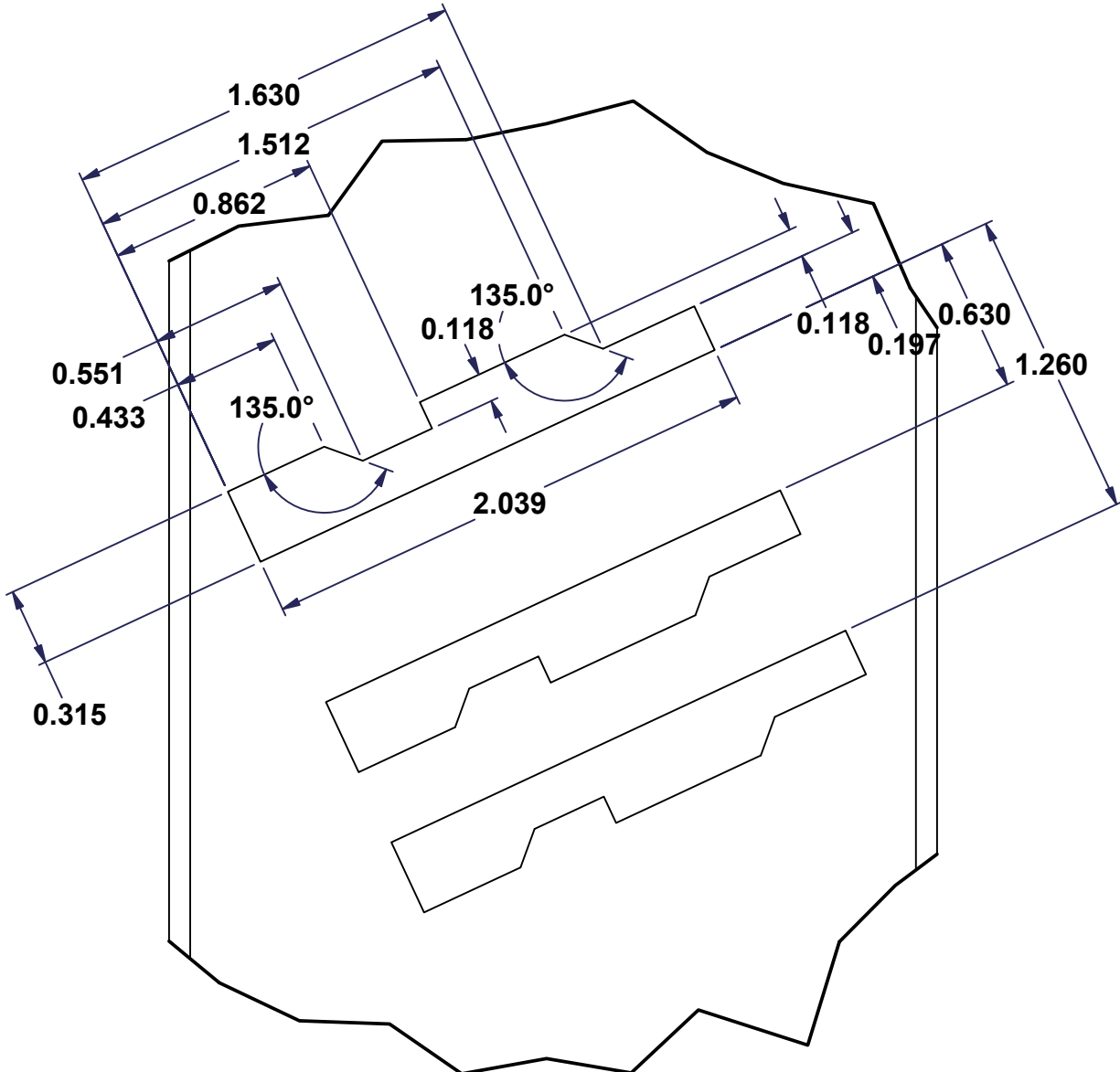

DETAIL C

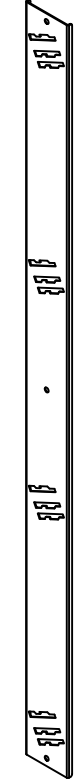

Isometric View



Tél: (450) 979-4373 Fax: (450) 979-4626 www.exmweb.com	Flatness Aplatissement	Max 3.0mm
	Projection	
Customer Client	Date	
Drawn By Dessiné Par	BoxCad: Patrick Deschênes	Date 10/21/2020
Material Matière	16 Ga Galvanized (1.4mm)	
Color Couleur	Unpainted	Finish Fini Galvanized
Description	Detail Rev.	
1412T6604 Inner Panel		
Part Number Numéro Pièce	Rev.	5
1412T6604IP	0	5

Qty	Part Number	Rev.	Description
1	1412T6604IP-P	0	1412T6604 Inner Panel

Parts List