

All knockouts are actual size

Les disques défonçables sont grandeur réel

This drawing is confidential and must not be reproduced or used without the consent of EXM

Ce dessin est confidentiel et ne doit pas être reproduit ou utilisé sans le consentement de EXM

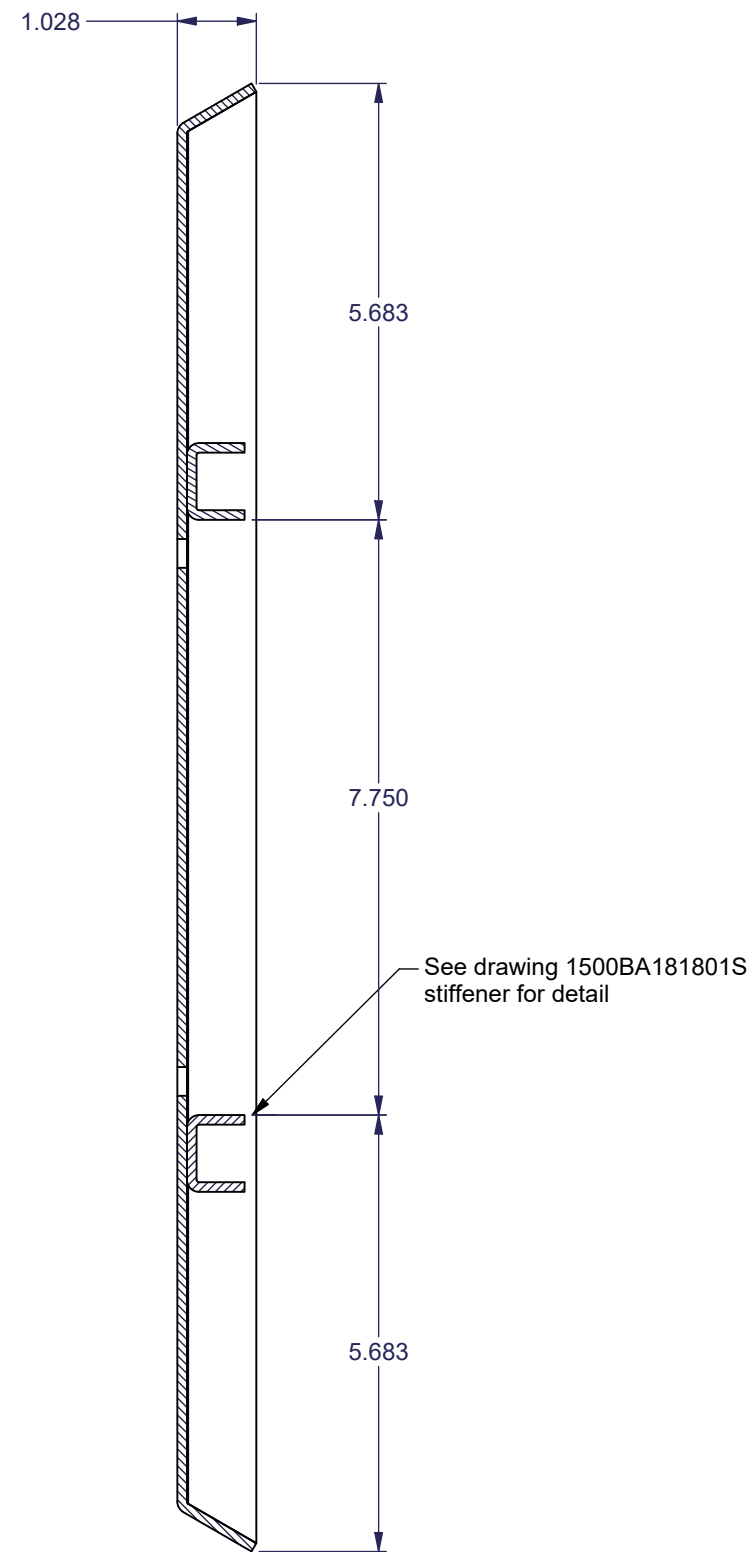
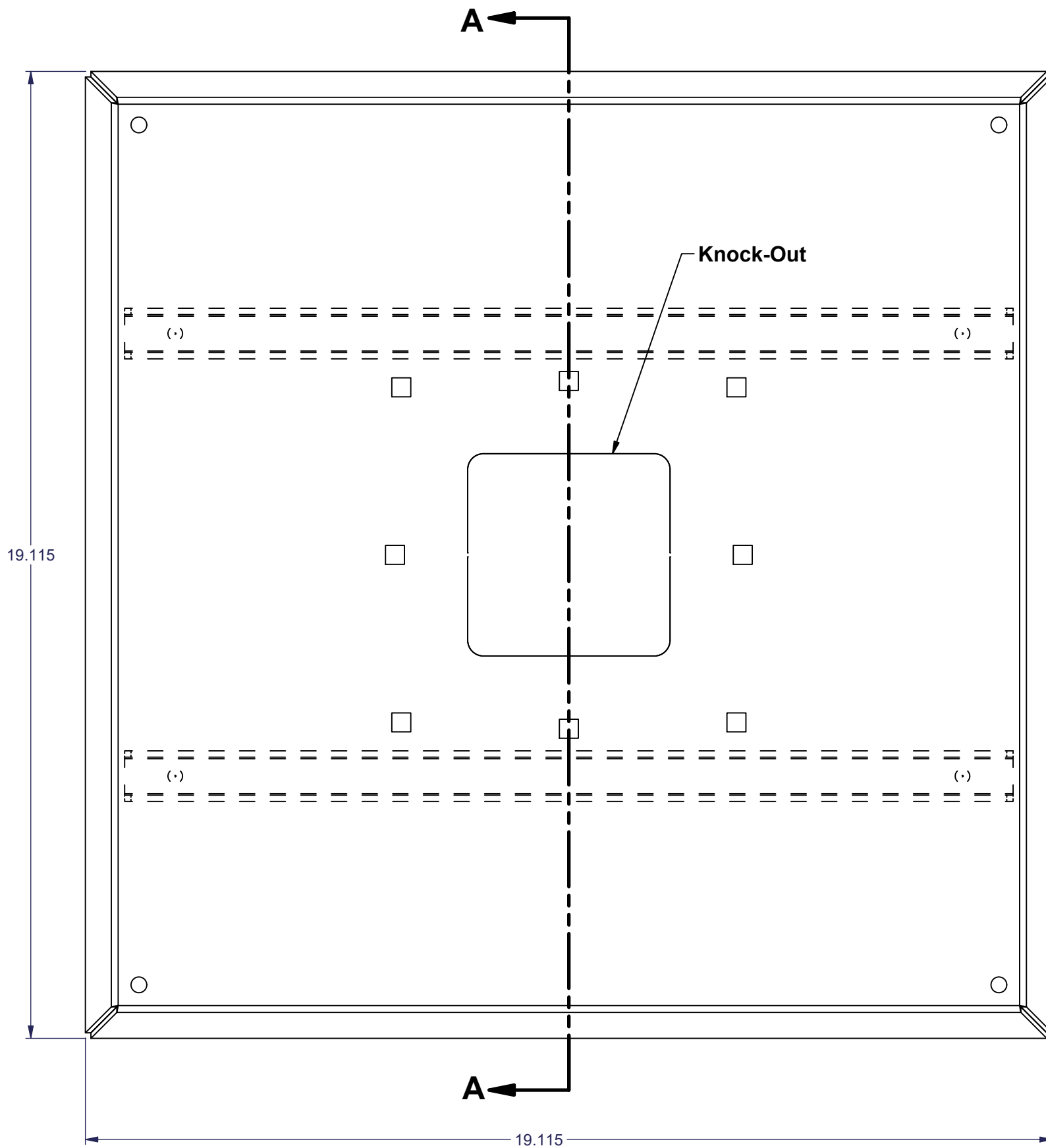

SECTION A-A

No.	Revisions	Date	By/Par
1	Was in 12 Ga H.R.P. & O.	4/1/2002	Patrick
2	Was in 14 Ga H.R.P. & O.	26/10/2007	G.Turpin
3	Update 2D sheet template to new style and add 4" x 4" cutout on base	12/27/2013	AllenL
3.1	Change cutout to knockout	12/31/2013	AllenL

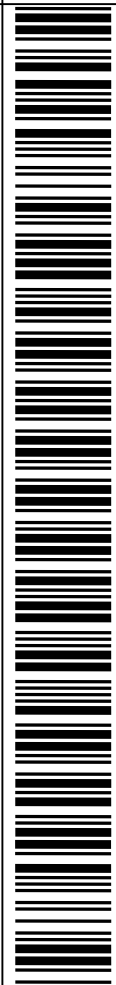
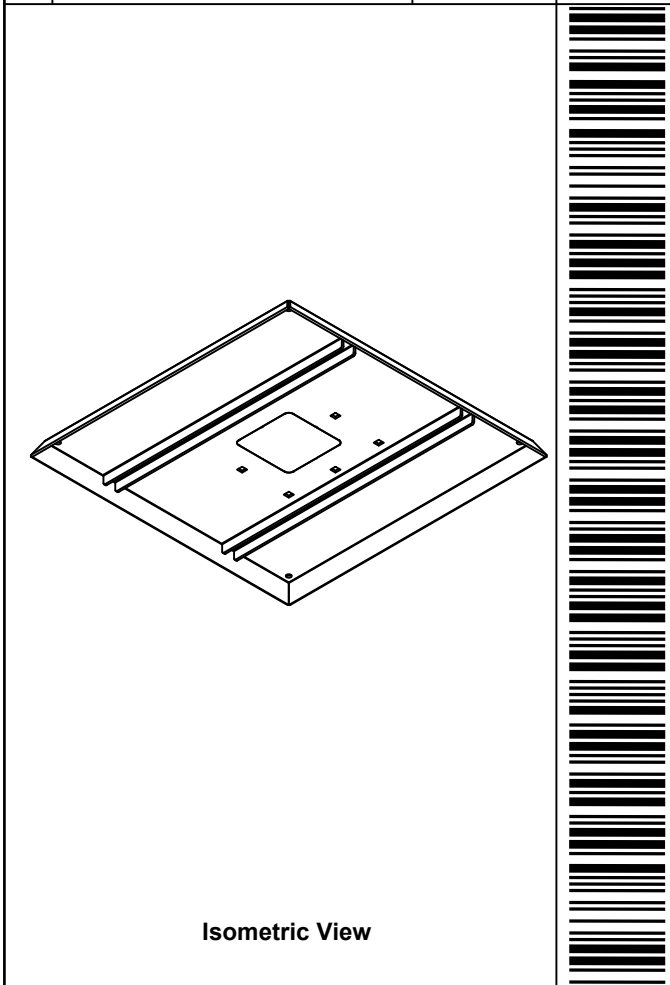

Tél: (450) 979-4373 Fax: (450) 979-4626 www.exmweb.com		Flatness Aplatissement Max 3.0mm
Projection 		
Customer Client	Date	
Drawn By Dessiné Par Patrick Deschenes	Date 12/18/2001	
Material Matière	11 Ga H.R.P. & O.	
Color Couleur	Asa-61 Grey	Finish Fini Smooth
Description	Detail Rev.	
1500 BA Assembly		
Part Number Numéro Pièce	Rev.	1
1500BA181801	3	1

Parts List						
Item	Qty	Part Number	Rev	Description	Material	Color
1	1	1500BA181801B	3	1500 BA181801 Base	11 Ga H.R.P. & O. (3.0mm)	Asa-61 Grey
2	2	1500BA181801S	3	1500BA Stiffener	11 Ga H.R.P. & O. (3.0mm)	Asa 61 Grey

All knockouts are actual size

Les disques défonçables sont grandeur réel

This drawing is confidential and must not be reproduced or used without the consent of EXM

Ce dessin est confidentiel et ne doit pas être reproduit ou utilisé sans le consentement de EXM

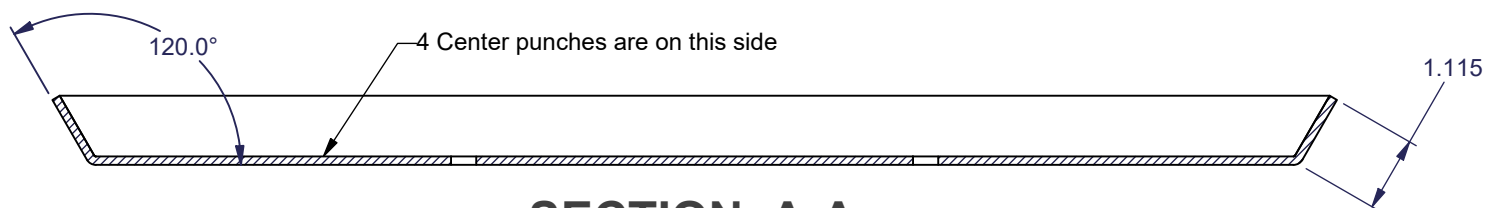

SECTION A-A

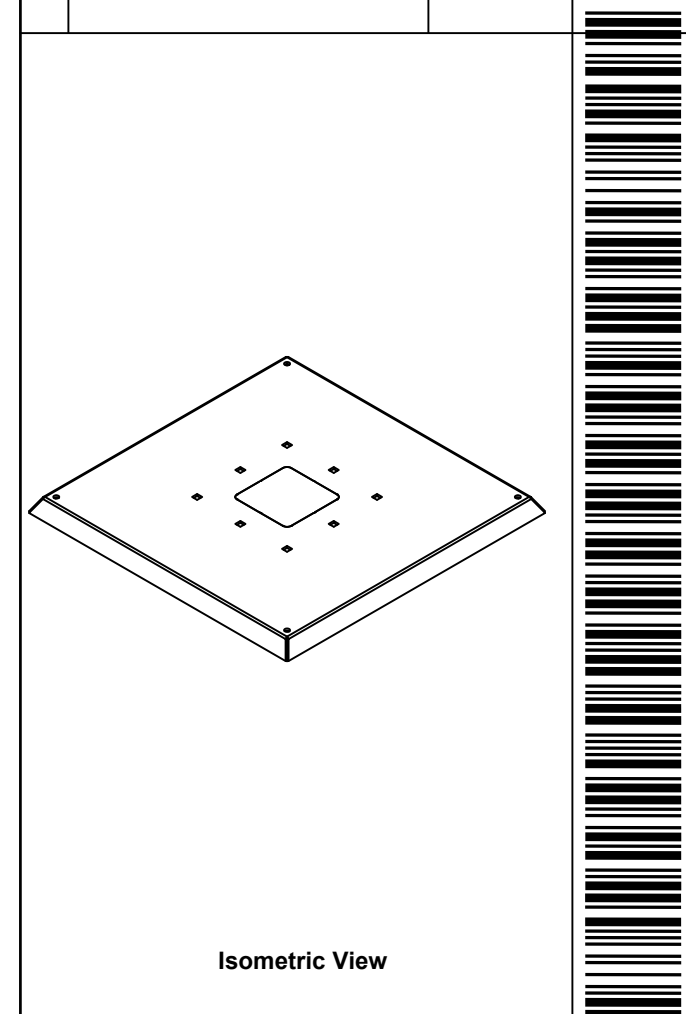
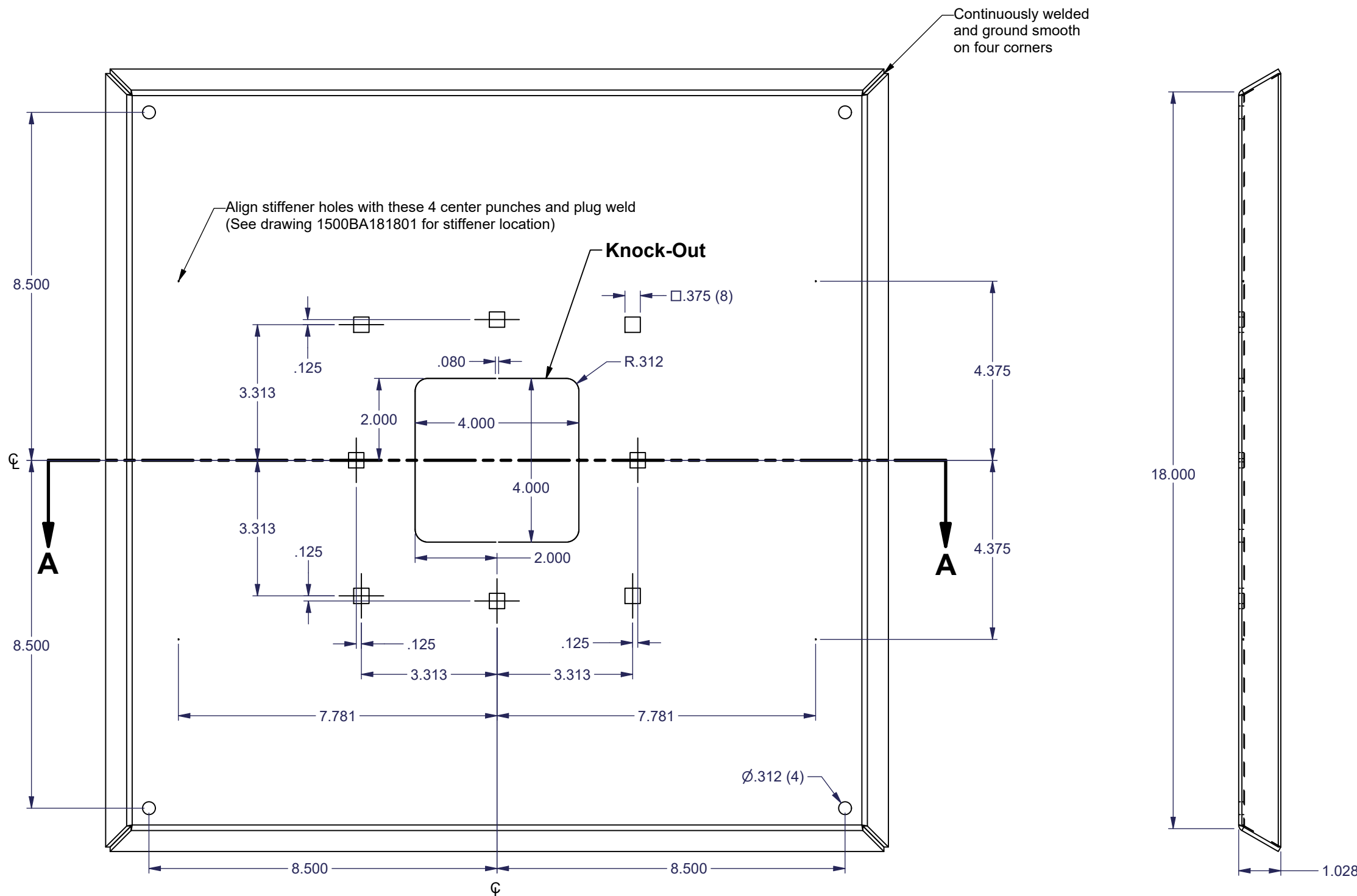

Isometric View

		Flatness Aplatissement Max 3.0mm Projection 	
Tél: (450) 979-4373 Fax: (450) 979-4626 www.exmweb.com		Customer Client Date	
Drawn By Dessiné Par Patrick Deschenes		Date 12/18/2001	
Material Matière 11 Ga H.R.P. & O.			
Color Couleur Asa-61 Grey		Finish Fini Smooth	
Description 1500 BA181801 Base			Detail Rev.
Part Number Numéro Pièce 1500BA181801B			Rev. 3

Parts List							
Item	Qty	Part Number	Rev	Description	Material	Color	FINISH
1	1	1500BA181801B	3	1500 BA181801 Base	11 Ga H.R.P. & O. (3.0mm)	Asa-61 Grey	Smooth

1
1

All knockouts are actual size

Les disques défonçables sont grandeur réel

This drawing is confidential and must not be reproduced or used without the consent of EXM

Ce dessin est confidentiel et ne doit pas être reproduit ou utilisé sans le consentement de EXM

No.	Revisions	Date	By/Par
1	Was in 12 Ga H.R.P. & O.	1/4/2002	Patrick
2	Was in 14 Ga H.R.P. & O.	10/26/2007	G.Turpin
3	Update 2D sheet template to new style and add 4" x 4" cutout on base	12/27/2013	AllenL

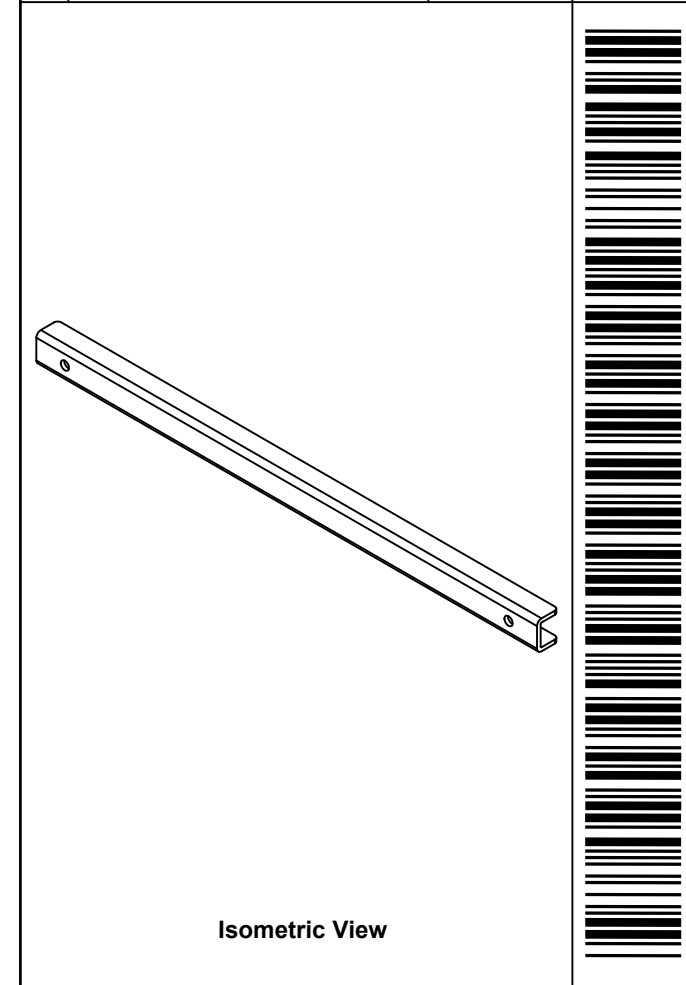
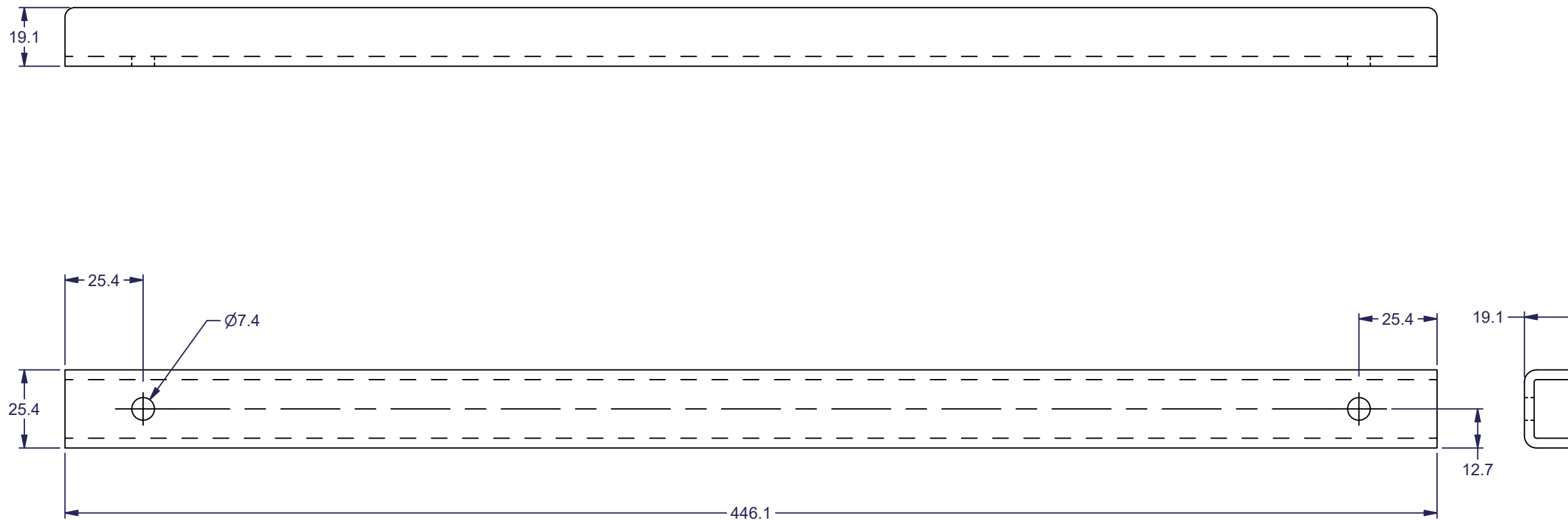

Note: - Required 2 per base

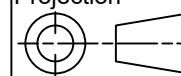
 Tél: (450) 979-4373 Fax: (450) 979-4626 www.exmweb.com		Flatness Aplatissement Max 3.0mm Projection 
Customer Client	EXM	Date
Drawn By / Dessiné Par	Patrick Deschenes	Date 12/18/2001
Material / Matière	11 Ga H.R.P. & O.	
Color / Couleur	Asa 61 Grey	Finish / Fini: Smooth
Description	1500BA Stiffener	
Part Number / Numéro Pièce	1500BA181801S	Rev. 3

Parts List							
Item	Qty	Part Number	Rev	Description	Material	Color	FINISH
1	1	1500BA181801S	3	1500BA Stiffener	11 Ga H.R.P. & O. (3.0mm)	Asa 61 Grey	Smooth

1/1