

All knockouts are actual size

Les disques défonçables sont grandeur réel

This drawing is confidential and must not be reproduced or used without the consent of EXM

Ce dessin est confidentiel et ne doit pas être reproduit ou utilisé sans le consentement de EXM

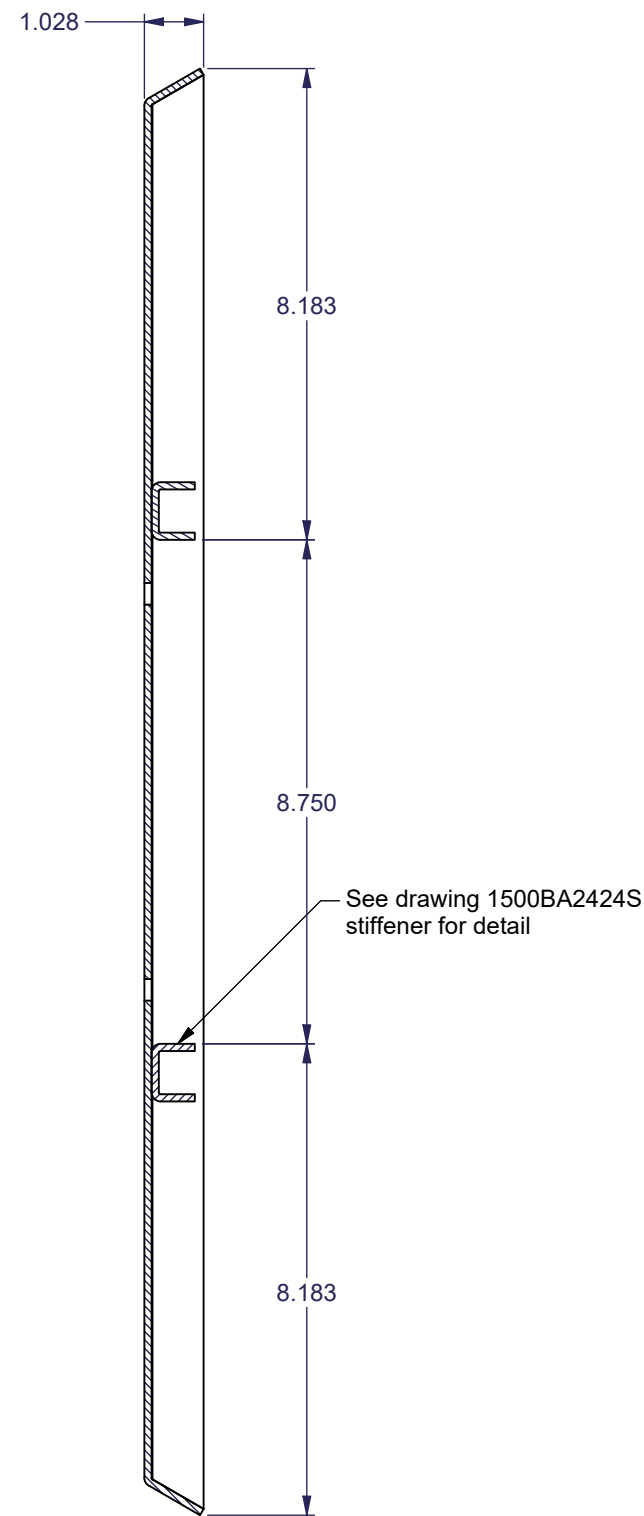
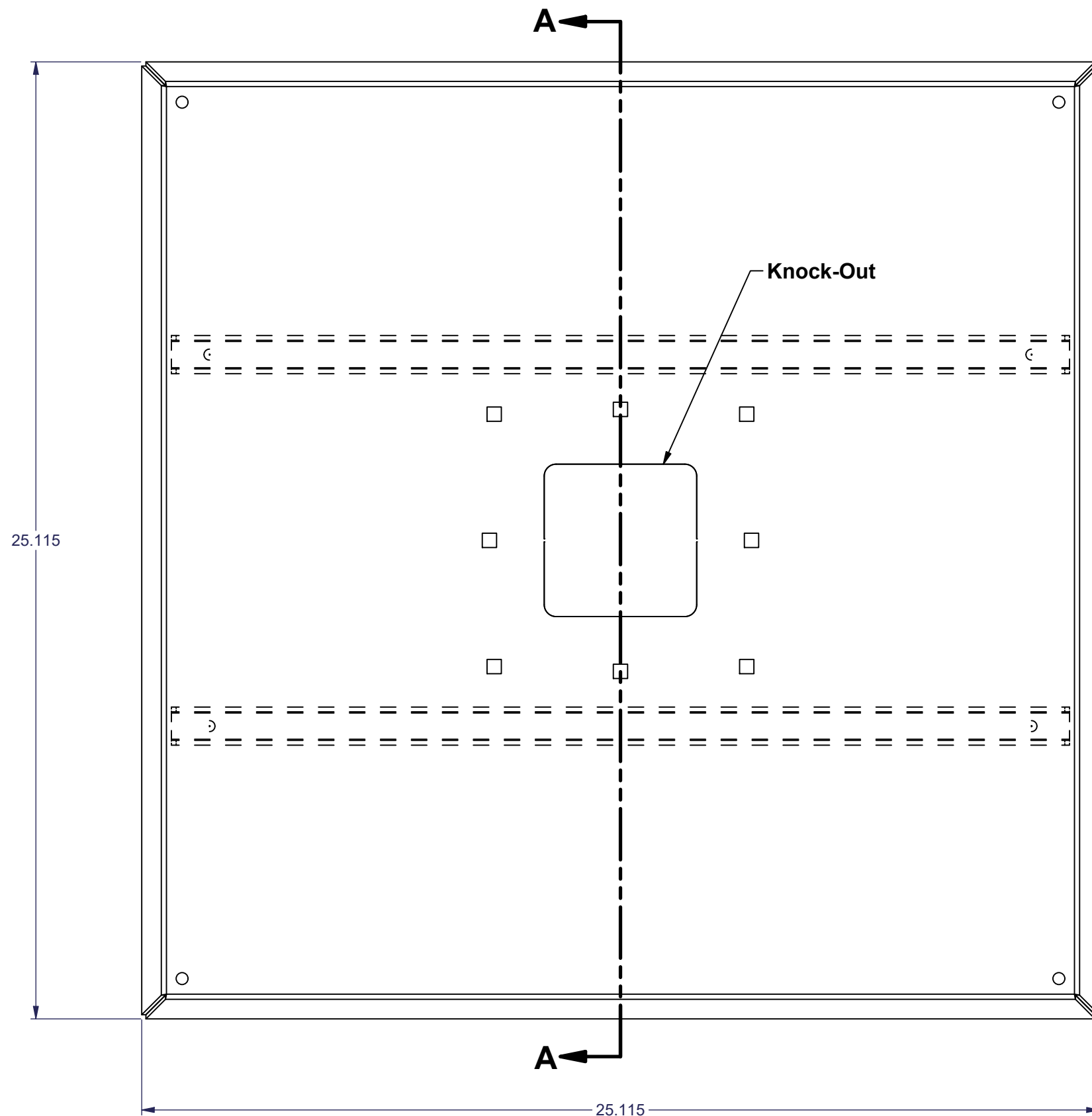

**SECTION A-A**

No.	Revisions	Date	By/Par
1	Was in 12 Ga H.R.P. & O.	3/1/2002	Patrick
2	Was in 14 Ga H.R.P. & O.	26/10/2007	G.Turpin
3	Update 2D sheet template to new style and add 4" x 4" cutout on base	27/12/2013	AllenL
3.1	Change cutout to knockout	31/12/2013	AllenL

**Isometric View**

		Flatness Aplatissement Max 3.0mm	
Tél: (450) 979-4373 Fax: (450) 979-4626 www.exmweb.com		Projection 	
Customer Client		Date	
Drawn By / Dessiné Par: Patrick Deschenes		Date: 3/3/2001	
Material / Matière: 11 Ga H.R.P. & O.			
Color / Couleur: Asa-61 Grey		Finish / Fini: Smooth	
Description: 1500 Base 24" x 24" x 01"		Detail Rev.	
Part Number / Numéro Pièce: <b>1500BA242401</b>		Rev. 3	

Parts List							
Item	Qty	Part Number	Rev	Description	Material	Color	FINISH
1	1	1500BA242401B	3	1500 Base 24" x 24" x 01"	11 Ga H.R.P. & O. (3.0mm)	Asa-61 Grey	Smooth
2	2	1500BA2424S	3	1500BA Stiffener	11 Ga H.R.P. & O. (3.0mm)	Asa-61 Grey	Smooth

All knockouts are actual size

Les disques défonçables sont grandeur réel

This drawing is confidential and must not be reproduced or used without the consent of EXM

Ce dessin est confidentiel et ne doit pas être reproduit ou utilisé sans le consentement de EXM

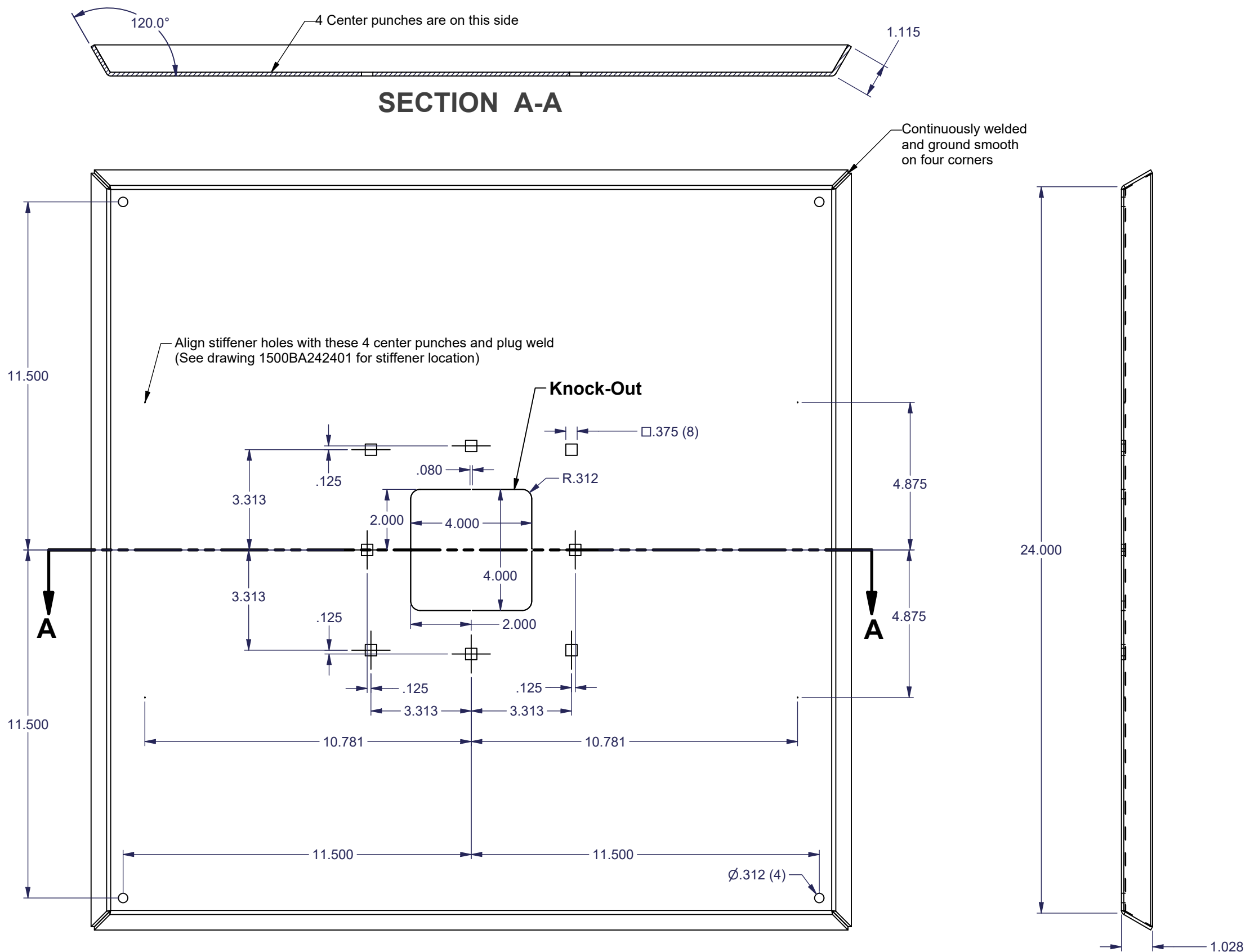

No.	Revisions	Date	By/Par
1	Was in 12 Ga H.R.P. & O.	3/1/2002	Patrick
2	Was in 14 Ga H.R.P. & O.	26/10/2007	G.Turpin
3	Update 2D sheet template to new style and add 4" x 4" cutout on base	27/12/2013	AllenL
3.1	Change cutout to knockout	31/12/2013	AllenL

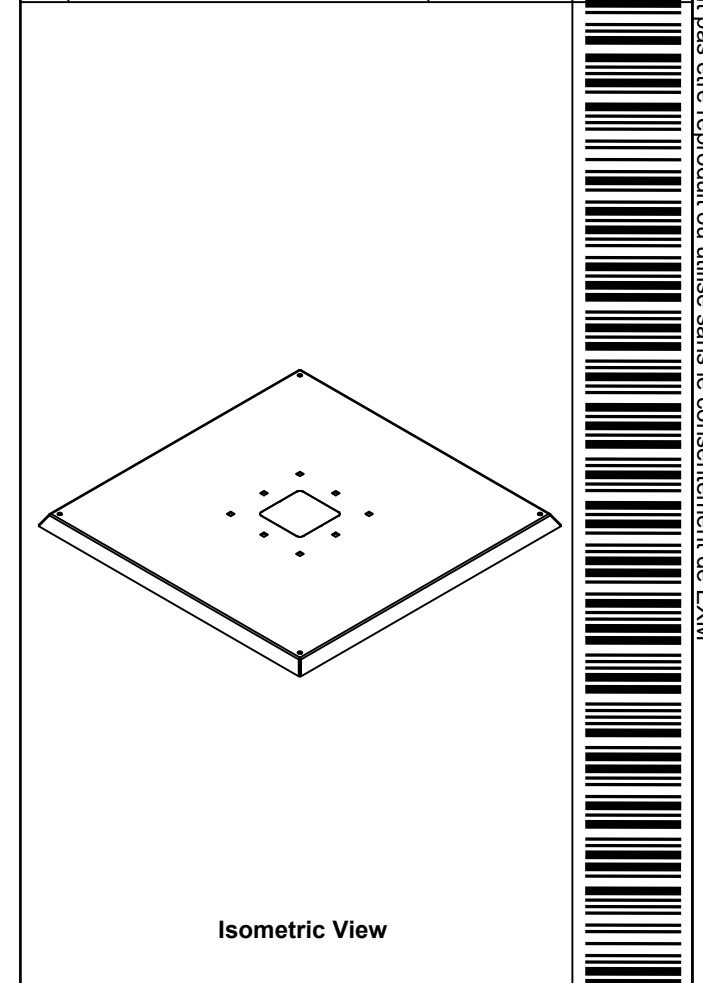

		Flatness Aplatissement Max 3.0mm Projection	
Tél: (450) 979-4373 Fax: (450) 979-4626 www.exmweb.com		Date 18/12/2001	
Customer Client		Date	
Drawn By Dessiné Par Patrick Deschenes		Date	
Material Matière 11 Ga H.R.P. & O. (3.0mm)		Finish Fini Smooth	
Color Couleur Asa-61 Grey		Detail Rev.	
Description 1500 Base 24" x 24" x 01"		Detail Rev.	
Part Number Numéro Pièce <b>1500BA242401B</b>		Rev. <b>3</b>	

Parts List							
Item	Qty	Part Number	Rev	Description	Material	Color	FINISH
1	1	1500BA242401B	3	1500 Base 24" x 24" x 01"	11 Ga H.R.P. & O. (3.0mm)	Asa-61 Grey	Smooth

All knockouts are actual size

Les disques défonçables sont grandeur réel

This drawing is confidential and must not be reproduced or used without the consent of EXM

Ce dessin est confidentiel et ne doit pas être reproduit ou utilisé sans le consentement de EXM

No.	Revisions	Date	By/Par
1	Was In 12 Ga H.R.P. & O.	3/1/2002	Patrick
2	Was in 14 Ga H.R.P. & O.	26/10/2007	G.Turpin
3	Created 2D drawing	27/12/2013	AllenL

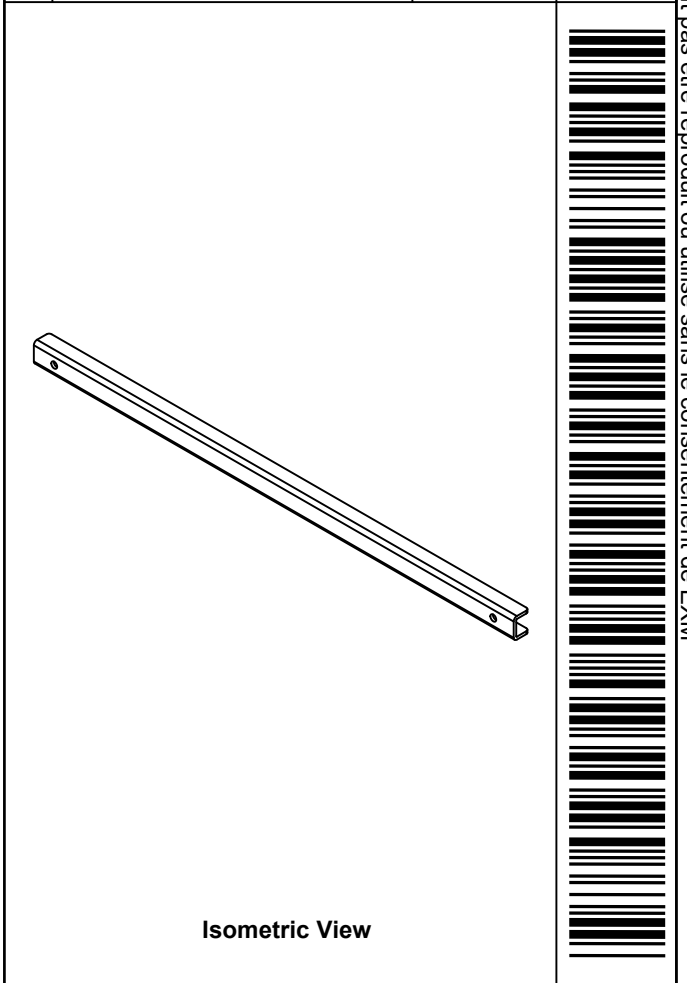
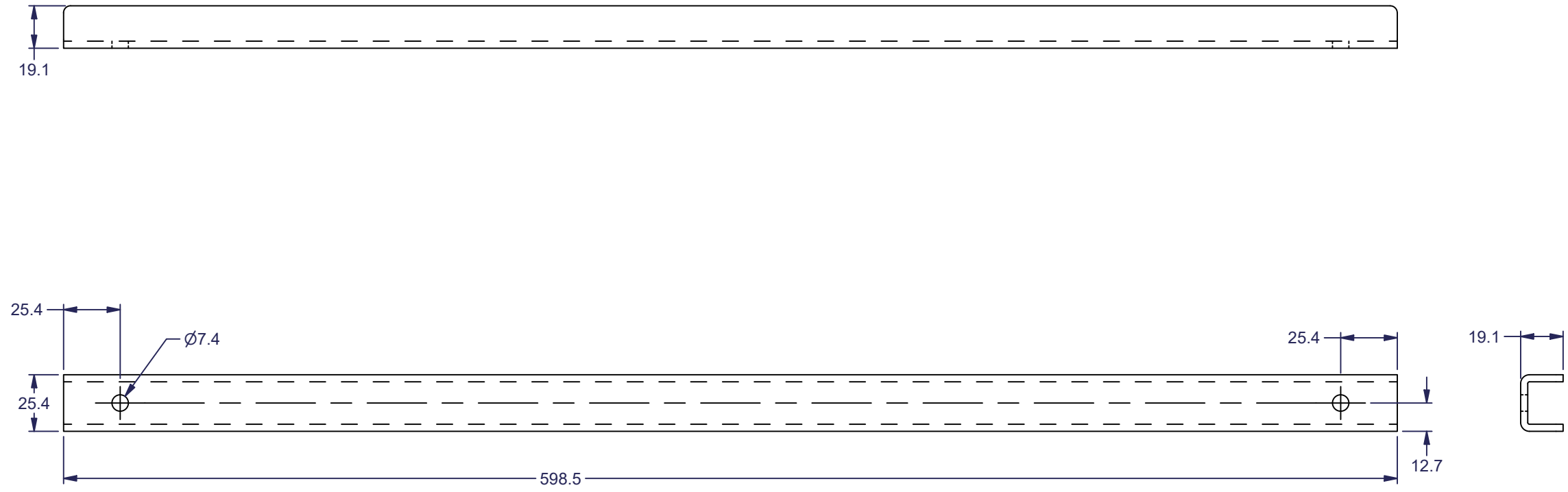

Note: - Required 2 per base

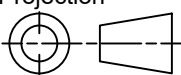
 Tél: (450) 979-4373 Fax: (450) 979-4626 www.exmweb.com		Flatness Aplatissement Max 3.0mm Projection 
Customer Client	EXM	Date
Drawn By Dessiné Par	Patrick Deschenes	Date 18/12/2001
Material Matière		
Color Couleur	Asa-61 Grey	Finish Fini Smooth
Description	1500BA Stiffener	Detail Rev.
Part Number Numéro Pièce	<b>1500BA2424S</b>	Rev. <b>3</b>

Parts List							
Item	Qty	Part Number	Rev	Description	Material	Color	FINISH
1	1	1500BA2424S	3	1500BA Stiffener	11 Ga H.R.P. & O. (3.0mm)	Asa-61 Grey	Smooth