

This drawing is confidential and must not be reproduced or used without the consent of EXM

Ce dessin est confidentiel et ne doit pas être reproduit ou utilisé sans le consentement de EXM

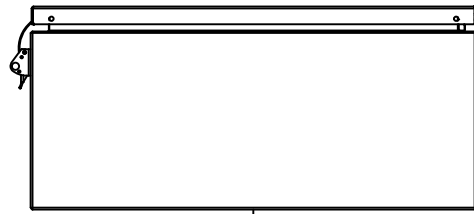

TOP

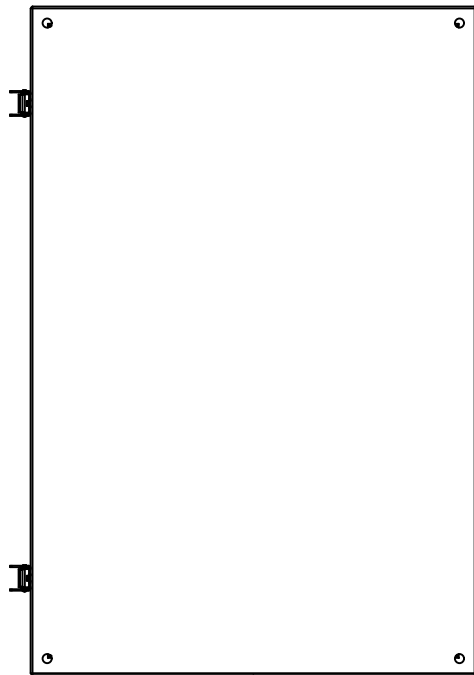

BACK

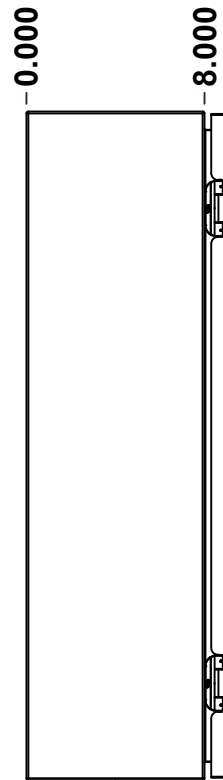

LEFT

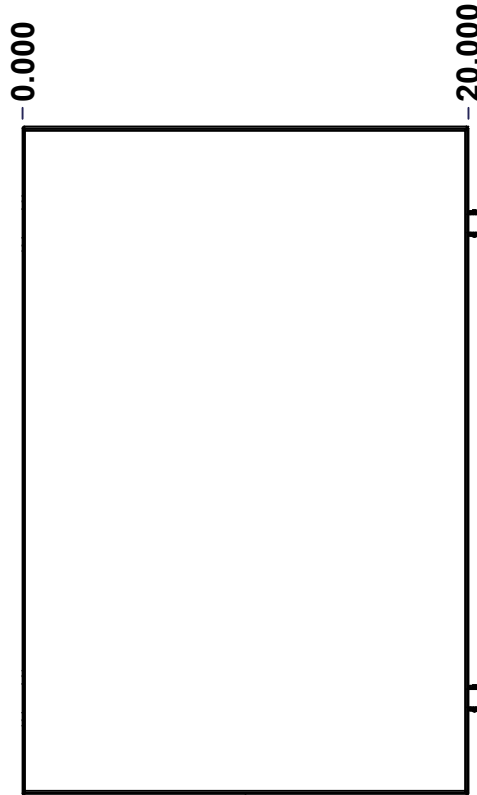

FRONT

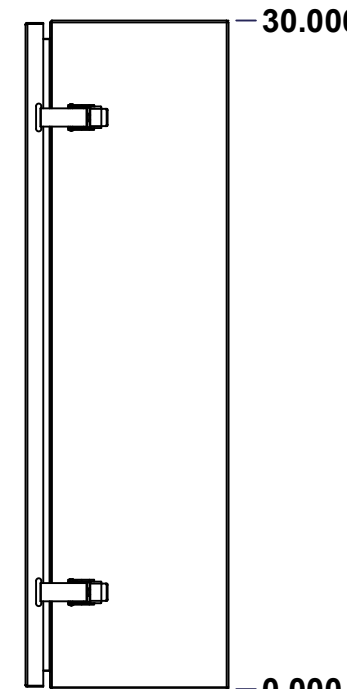

RIGHT

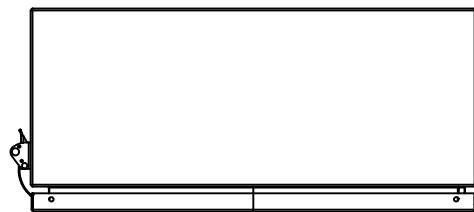

BOTTOM

| No. | Revisions | Date | By/Par |
|-----|-----------|------|--------|
| | | | |
| | | | |
| | | | |
| | | | |

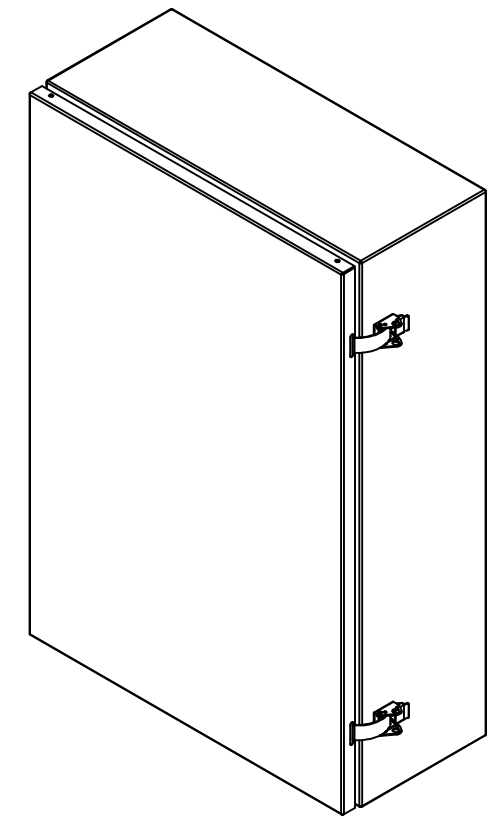

Isometric View

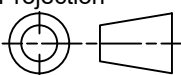

| | | |
|----------------------------------------------------------------------------------------------------------------------------------------------------------------------------------------|-------------------------------------------|-----------------------------------------------------------------------------------------------------------------------------------------------|
|  Tél: (450) 979-4373 Fax: (450) 979-4626 www.exmweb.com | | Flatness Aplatissement Max 3.0mm Projection  |
| Customer Client | Date | |
| Drawn By Dessiné Par | BoxCad: BoxCad | Date 10-May-13 |
| Material Matière | 16 Ga Cold Rolled A1008 CS Type B (1.4mm) | |
| Color Couleur | Asa-61 Grey | Finish Fini Smooth |
| Description | Detail Rev. | |
| 5300ES 30" x 20" x 8" Assembly | | |
| Part Number Numéro Pièce | Rev. | 1 |
| 5300ES302008 | 0 | 9 |

SEE BILL OF MATERIAL ON LAST PAGE

This drawing is confidential and must not be reproduced or used without the consent of EXM

Ce dessin est confidentiel et ne doit pas être reproduit ou utilisé sans le consentement de EXM

| NOTE | |
|------|--------------------------------------------|
| ITEM | DESCRIPTION |
| 1 | NEMA 3/3R Enclosure |
| 2 | C/W Standard ground studs on box and cover |
| 3 | W/O Standard door stiffener |
| 4 | C/W Standard inner panel (Included) |
| 5 | C/W Standard inner panel mounting studs |
| 6 | C/W 880 PP included (Not installed) |

| No. | Revisions | Date | By/Par |
|-----|-----------|------|--------|
| | | | |
| | | | |
| | | | |
| | | | |
| | | | |
| | | | |

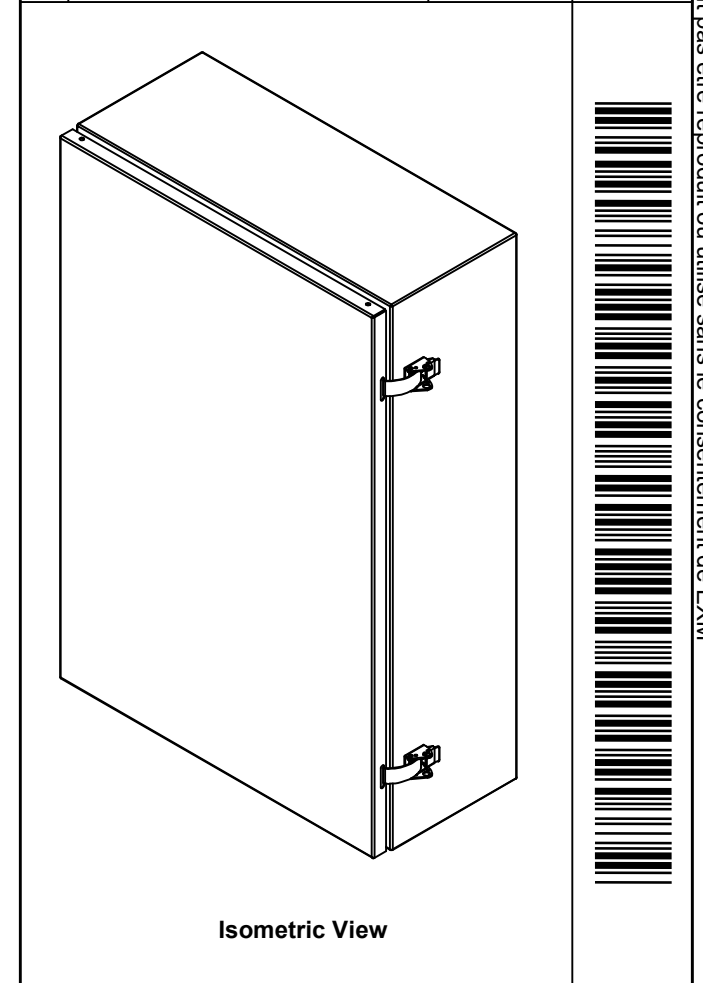

EXM
www.exmweb.com

Tél: (450) 979-4373
Fax: (450) 979-4626

Flatness
Aplatissement
Max 3.0mm

Projection

| | |
|----------------------------------------|-----------------|
| Customer Client | Date |
| Drawn By / Dessiné Par: BoxCad: BoxCad | Date: 10-May-13 |

| | |
|--------------------|-------------------------------------------|
| Material / Matière | 16 Ga Cold Rolled A1008 CS Type B (1.4mm) |
|--------------------|-------------------------------------------|

| | | | |
|-----------------|-------------|---------------|--------|
| Color / Couleur | Asa-61 Grey | Finish / Fini | Smooth |
|-----------------|-------------|---------------|--------|

| | | |
|-------------|--------------------------------|-------------|
| Description | 5300ES 30" x 20" x 8" Assembly | Detail Rev. |
|-------------|--------------------------------|-------------|

| | | | |
|----------------------------|---------------------|------|---|
| Part Number / Numéro Pièce | 5300ES302008 | Rev. | 0 |
|----------------------------|---------------------|------|---|

| Qty | Part Number | Rev | Description |
|------------|----------------|-----|--------------------------------------------|
| 1 | 881 SP3020G | 0 | 881 SP - Inner Panel |
| 2 | STK-K-01320 | 0 | 5412 ES Inner Panel Accessory Kit |
| 1 | 880 PP | 6 | Self Adhesive Print Pocket |
| 1 | STK-K-03000 | 1 | 5100 ES Accessory Kit |
| 1 | 5300ES302008C | 0 | 5300ES 30" x 20" Cover |
| 1 | 5300ES302008B | 0 | 5300ES 30" x 20" x 8" Body |
| 2 | STK-K-11910 | 3 | Stainless Steel Draw Pull Latch (Long) |
| 2 | STK-Q-04050-08 | 0 | M6 x 8mm Hexagon Socket Head Machine Screw |
| Parts List | | | |

| PACKING | | |
|-----------------------|-----|--------------------------------------------|
| ITEM | QTY | DESCRIPTION |
| Cardboard sleeve | 2 | Top and Bottom |
| Cardboard strip | 2 | Between back of enclosure and inner panel |
| Plastic bag | 1 | To protect cover surface and inside gasket |
| Plastic strap - Black | 2 | To Squeeze the 2 cardboard sleeve together |
| Packaging label | 1 | White label with product number |

This drawing is confidential and must not be reproduced or used without the consent of EXM

Ce dessin est confidentiel et ne doit pas être reproduit ou utilisé sans le consentement de EXM

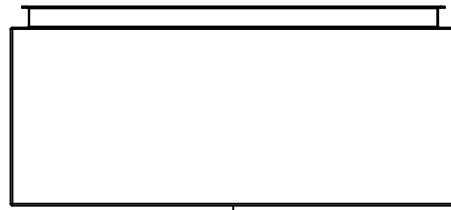

TOP

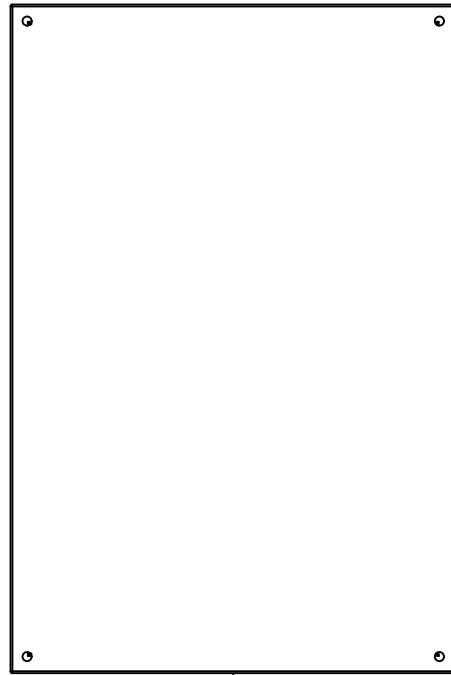

BACK

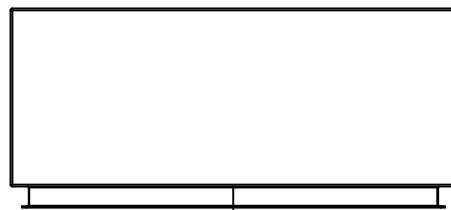

BOTTOM

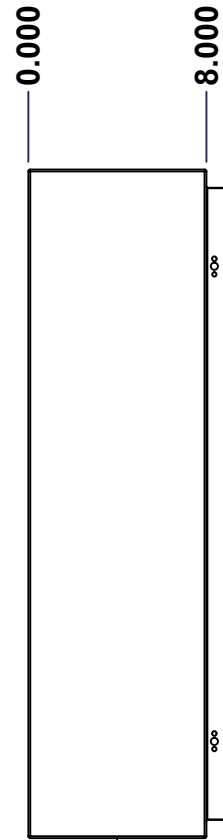

LEFT

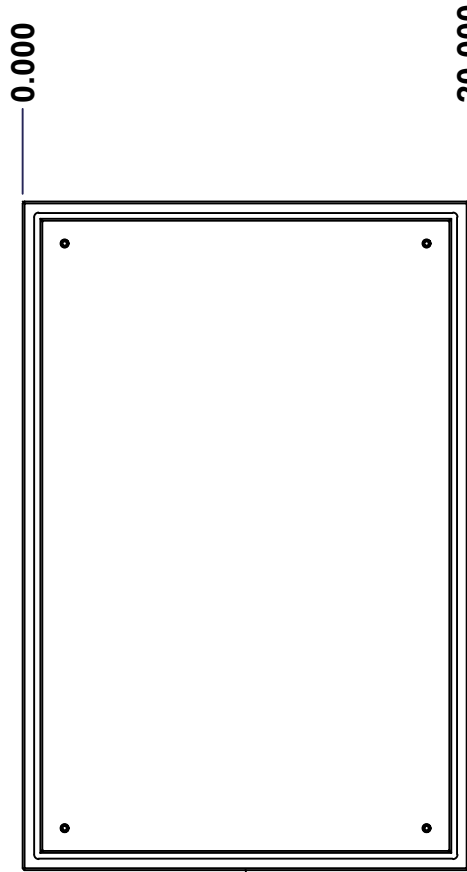

FRONT

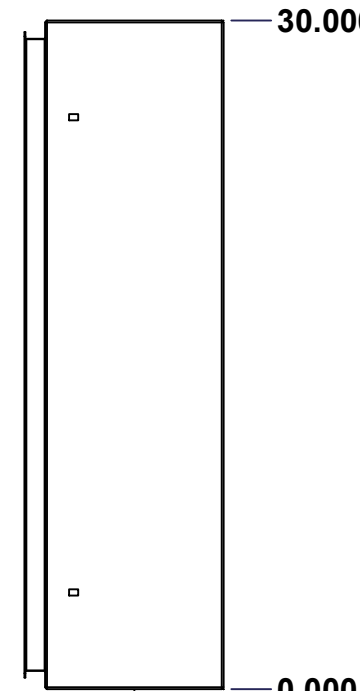

RIGHT

| No. | Revisions | Date | By/Par |
|-----|-----------|------|--------|
| | | | |
| | | | |
| | | | |
| | | | |

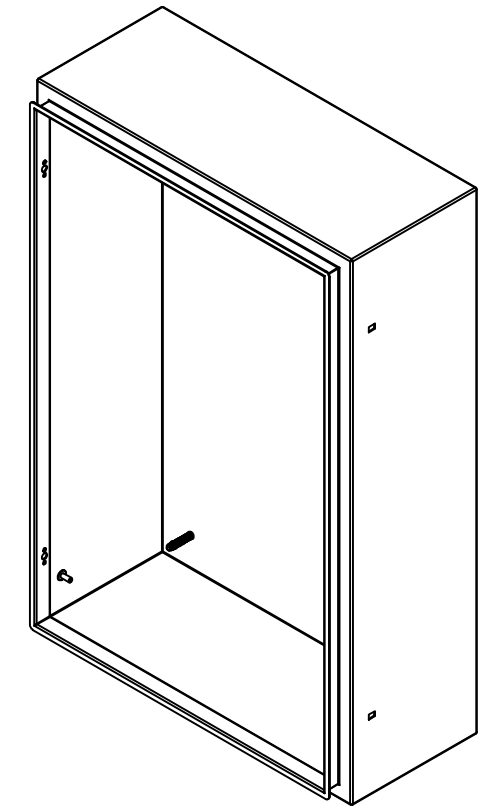

Isometric View



Tél: (450) 979-4373
 Fax: (450) 979-4626
www.exmweb.com

Flatness
Aplatissement

Max 3.0mm

Projection



| | |
|---------------------------------------------------------------|-----------------------|
| Customer Client | Date |
| Drawn By Dessiné Par BoxCad: BoxCad | Date 10-May-13 |
| Material Matière 16 Ga Cold Rolled A1008 CS Type B (1.4mm) | |
| Color Couleur Asa-61 Grey | Finish Fini Smooth |
| Description 5300ES 30" x 20" x 8" Body | Detail Rev. |
| Part Number Numéro Pièce 5300ES302008B | Rev. 3 0 |

SEE BILL OF MATERIAL ON LAST PAGE

This drawing is confidential and must not be reproduced or used without the consent of EXM

Ce dessin est confidentiel et ne doit pas être reproduit ou utilisé sans le consentement de EXM

STANDARD FEATURES ARE NOT LISTED IN THIS HOLE TABLE

HOLE TABLE - LEFT VIEW (CUSTOM FEATURE ONLY)

| CUT-OUT | XDIM | YDIM | DESCRIPTION |
|---------|-------|-------|-----------------------------|
| 1 | 6.500 | 2.000 | GND STUD M6 x 16mm (Inside) |

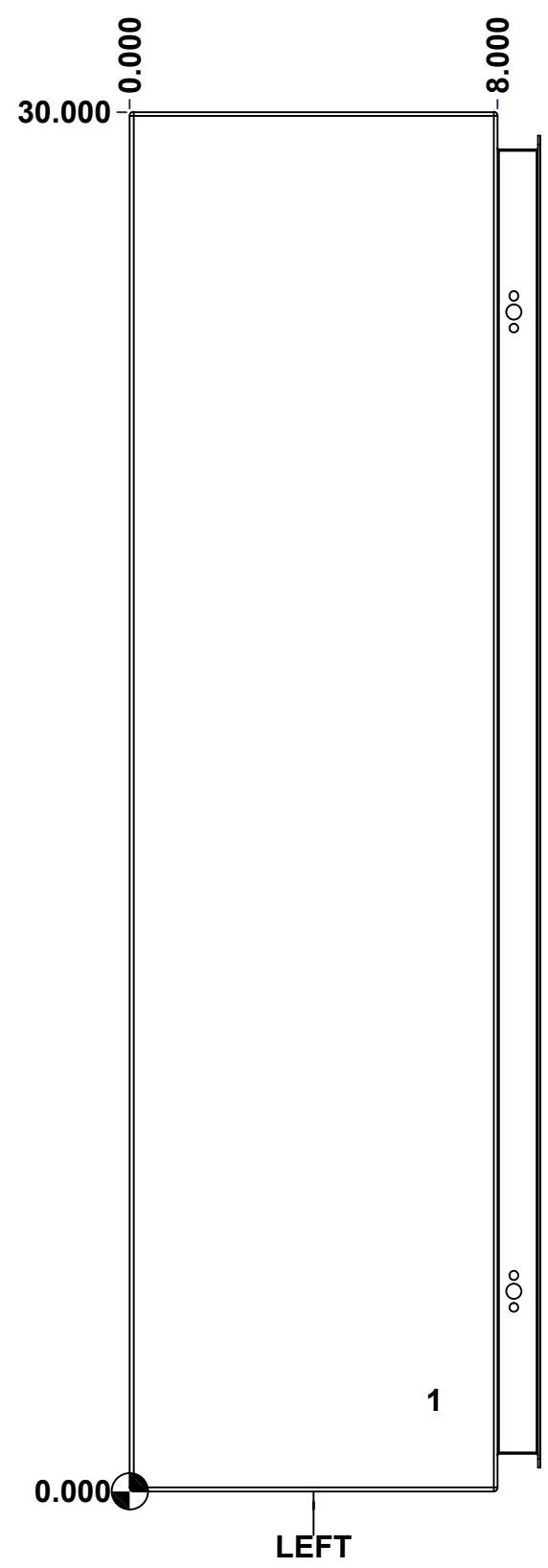

| | | | |
|--|-----------------------------|----------|-----|
| | Description | Status | |
| | 5300ES 30" x 20" x 8" Body | (NULL) | |
| | Part Number Numéro Pièce | Rev. | |
| | 5300ES302008B | 0 | 4/9 |

This drawing is confidential and must not be reproduced or used without the consent of EXM

Ce dessin est confidentiel et ne doit pas être reproduit ou utilisé sans le consentement de EXM

STANDARD FEATURES ARE NOT LISTED IN THIS HOLE TABLE

HOLE TABLE - BACK VIEW (CUSTOM FEATURE ONLY)

| CUT-OUT | XDIM | YDIM | DESCRIPTION |
|---------|--------|--------|----------------------------|
| 1 | 1.875 | 1.875 | IP STUD M8 x 35mm (Inside) |
| 2 | 1.875 | 28.125 | IP STUD M8 x 35mm (Inside) |
| 3 | 18.125 | 28.125 | IP STUD M8 x 35mm (Inside) |
| 4 | 18.125 | 1.875 | IP STUD M8 x 35mm (Inside) |
| ----- | | | |
| 5 | 19.250 | 0.750 | RND Ø0.390 |
| 6 | 19.250 | 29.250 | RND Ø0.390 |
| 7 | 0.750 | 29.250 | RND Ø0.390 |
| 8 | 0.750 | 0.750 | RND Ø0.390 |

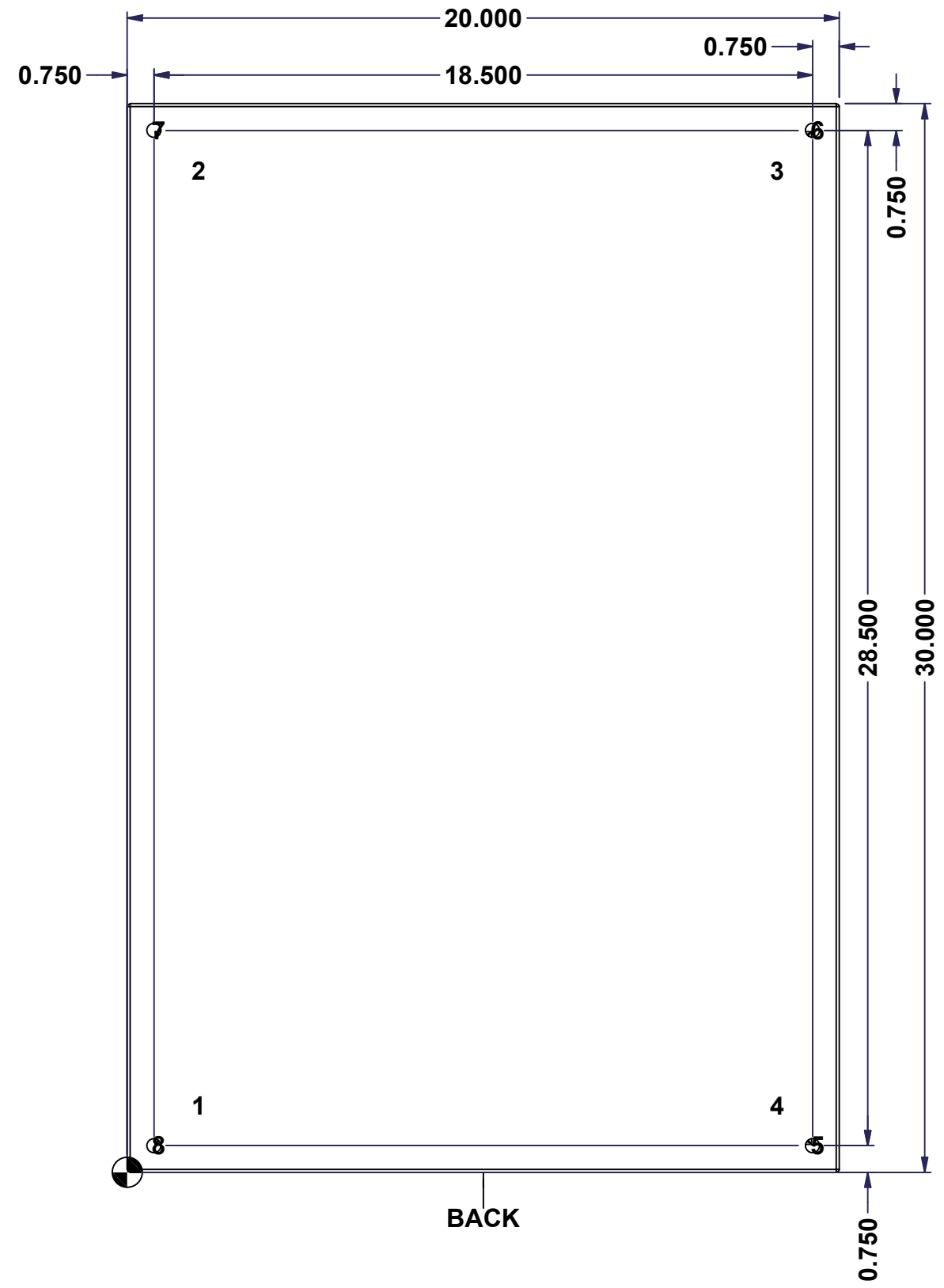

BACK

| | | | |
|--|-----------------------------|----------|---|
| | Description | Status | |
| | 5300ES 30" x 20" x 8" Body | (NULL) | |
| | Part Number Numéro Pièce | Rev. | 5 |
| | 5300ES302008B | 0 | 9 |

This drawing is confidential and must not be reproduced or used without the consent of EXM

Ce dessin est confidentiel et ne doit pas être reproduit ou utilisé sans le consentement de EXM

| No. | Revisions | Date | By/Par |
|-----|-----------|------|--------|
| | | | |
| | | | |
| | | | |
| | | | |
| | | | |

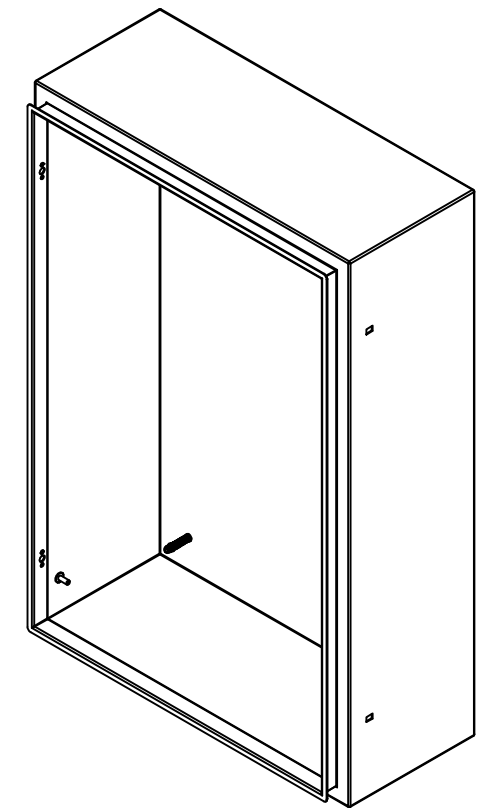

Isometric View



| | | |
|----------------------------------------------------------------------------------------------------------------------------------------------------------------------------------------|-----------------------|----------------------------------------|
|  Tél: (450) 979-4373 Fax: (450) 979-4626 www.exmweb.com | | Flatness Aplatissement Max 3.0mm |
| Customer Client | | Date |
| Drawn By / Dessiné Par: BoxCad: BoxCad | | Date: 10-May-13 |
| Material / Matière: 16 Ga Cold Rolled A1008 CS Type B (1.4mm) | | |
| Color / Couleur: Asa-61 Grey | Finish / Fini: Smooth | |
| Description: 5300ES 30" x 20" x 8" Body | | Detail Rev. |
| Part Number / Numéro Pièce: 5300ES302008B | | Rev. 6 0 / 9 |

| Qty | Part Number | Rev | Description |
|------------|-----------------|-----|--------------------------------------|
| 1 | STK-Q-16080 | 0 | Ground Stud M6 x 16mm Steel |
| 1 | STK-P-02400S | 0 | Powder Paint (Asa-61 Grey / Smooth) |
| 4 | STK-Q-16005 | 1 | Stud M8 x 35 (No Paint Cap Required) |
| 1 | 5300ES302008B-P | 0 | 5300ES 30" x 20" x 8" Body Part |
| Parts List | | | |

This drawing is confidential and must not be reproduced or used without the consent of EXM

Ce dessin est confidentiel et ne doit pas être reproduit ou utilisé sans le consentement de EXM



TOP

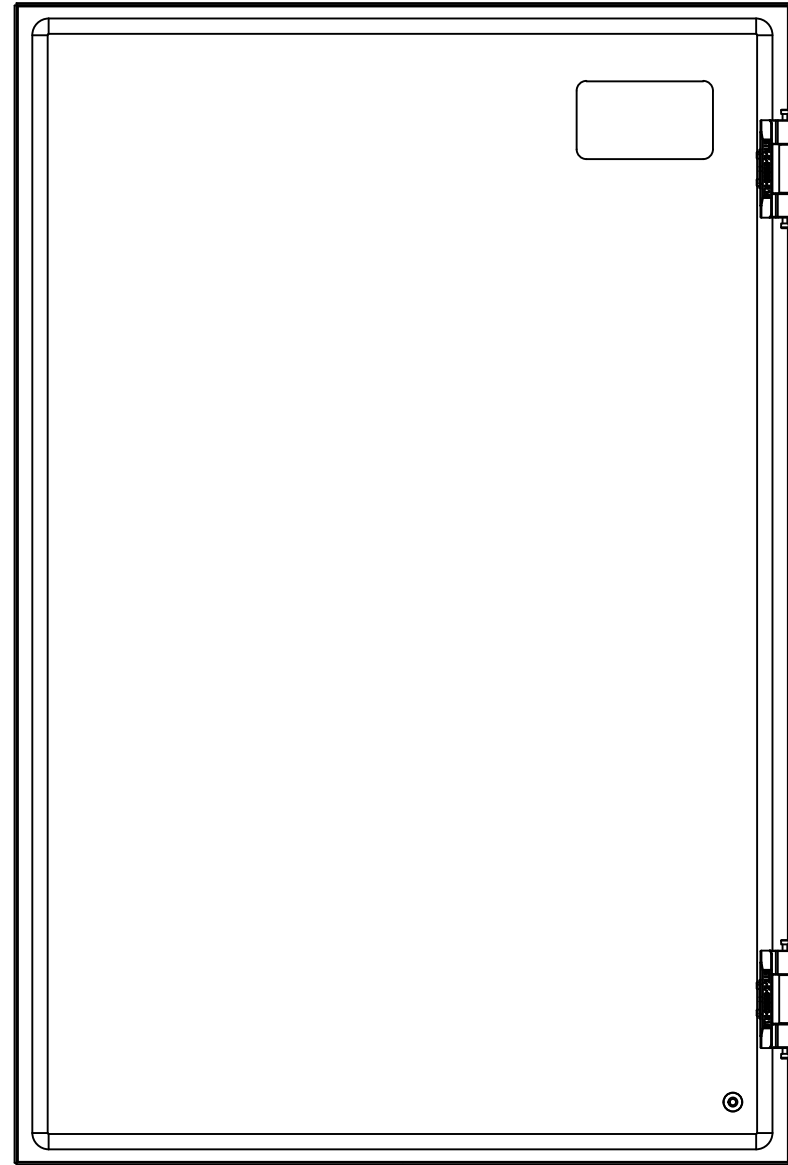

BACK

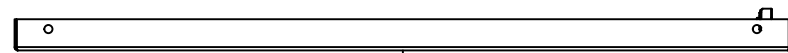

BOTTOM

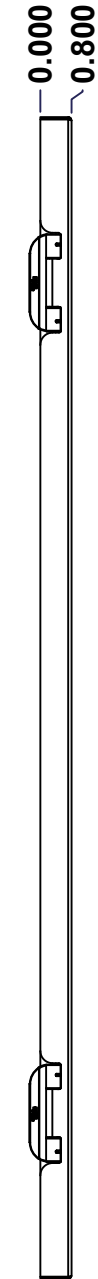

LEFT

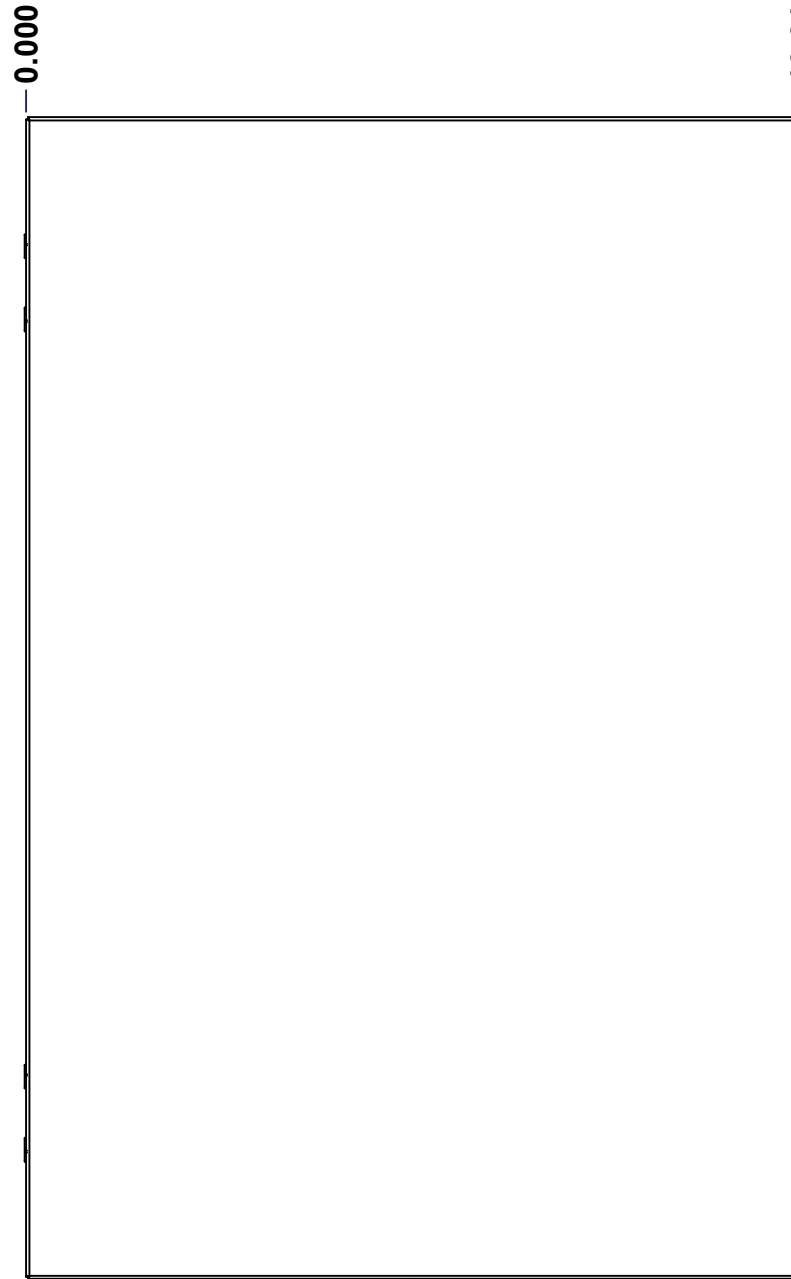

FRONT

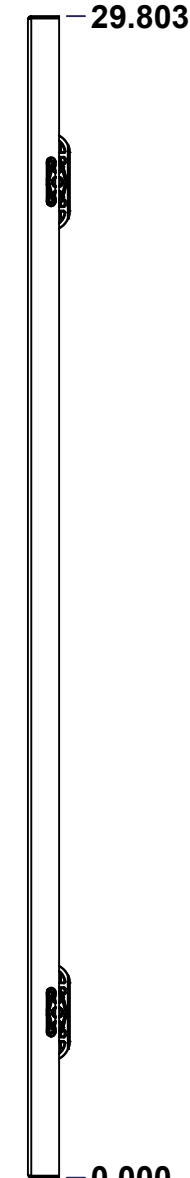

RIGHT

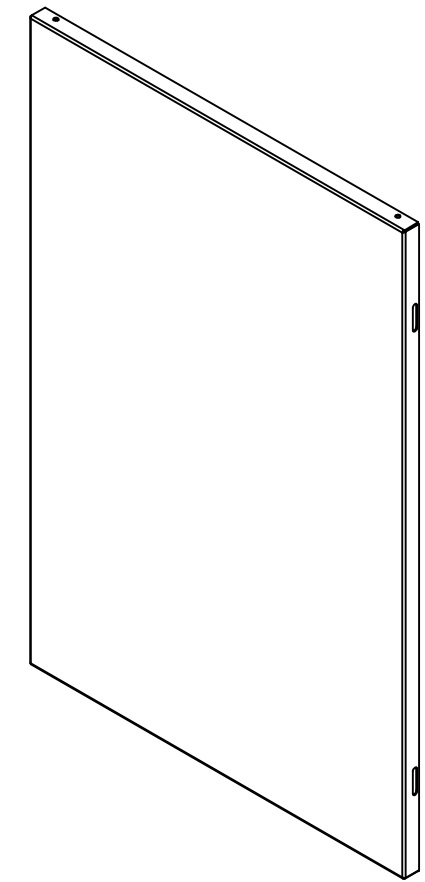

Isometric View

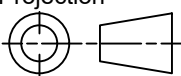

| No. | Revisions | Date | By/Par |
|-----|-----------|------|--------|
| | | | |
| | | | |
| | | | |
| | | | |

| | | |
|----------------------------------------------------------------------------------------------------------------------------------------------------------------------------------------|-------------------------------------------|-----------------------------------------------------------------------------------------------------------------------------------------------|
|  Tél: (450) 979-4373 Fax: (450) 979-4626 www.exmweb.com | | Flatness Aplatissement Max 3.0mm Projection  |
| Customer Client | Date | |
| Drawn By Dessiné Par | BoxCad: BoxCad | Date 10-May-13 |
| Material Matière | 16 Ga Cold Rolled A1008 CS Type B (1.4mm) | |
| Color Couleur | Asa-61 Grey | Finish Fini Smooth |
| Description | 5300ES 30" x 20" Cover | |
| Part Number Numéro Pièce | Rev. 0 | 7 9 |

SEE BILL OF MATERIAL ON LAST PAGE

5300ES302008C

This drawing is confidential and must not be reproduced or used without the consent of EXM

Ce dessin est confidentiel et ne doit pas être reproduit ou utilisé sans le consentement de EXM

| STANDARD FEATURES ARE NOT LISTED IN THIS HOLE TABLE | | | |
|-----------------------------------------------------|-------|--------|-----------------------------|
| HOLE TABLE - FRONT VIEW (CUSTOM FEATURE ONLY) | | | |
| CUT-OUT | XDIM | YDIM | DESCRIPTION |
| 1 | 1.486 | 1.614 | GND STUD M6 x 16mm (Inside) |
| 2 | 3.750 | 26.803 | LABEL_EXM (Inside) |

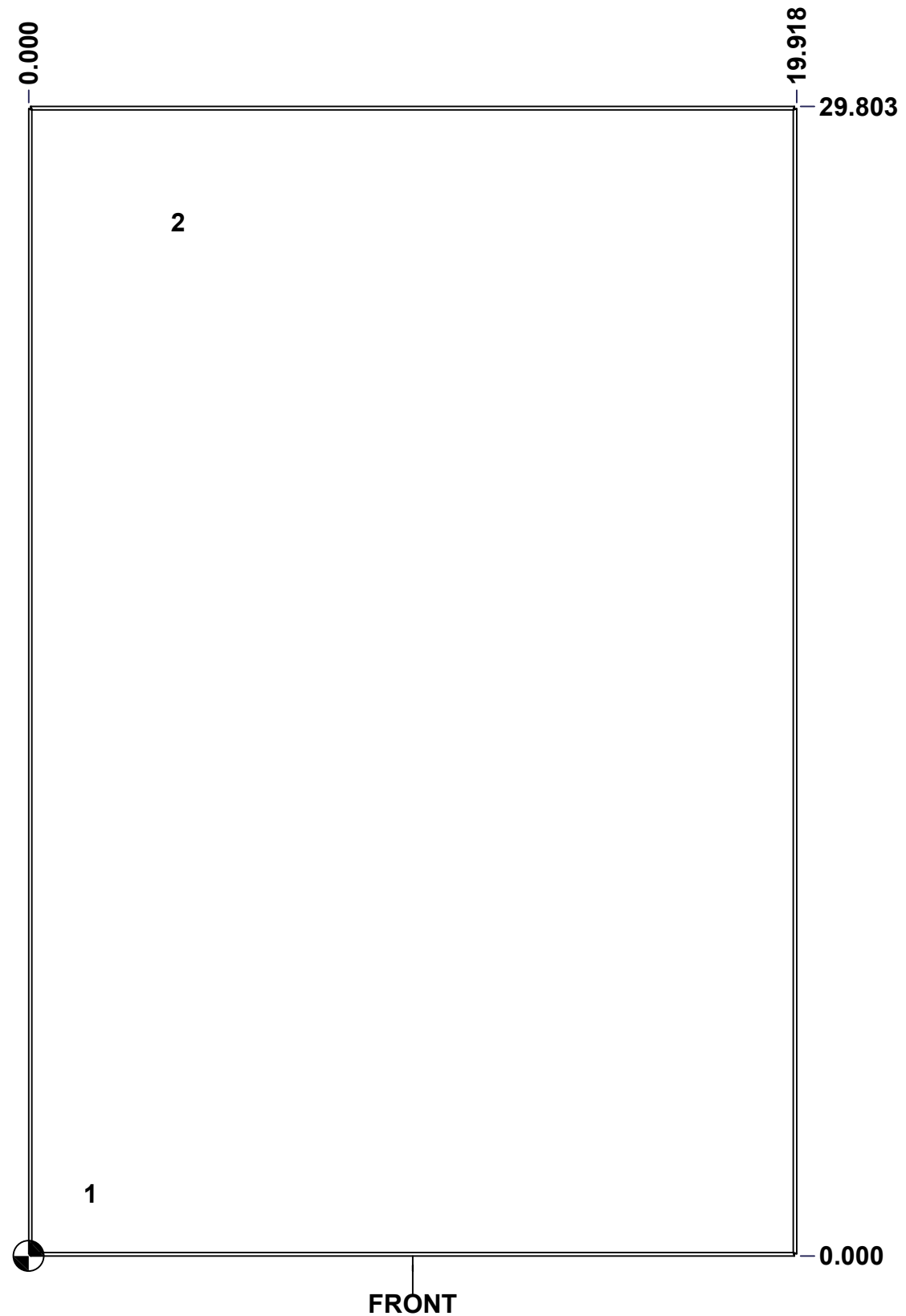

| | | | |
|--|-----------------------------|----------|-----|
| | Description | Status | |
| | 5300ES 30" x 20" Cover | (NULL) | |
| | Part Number Numéro Pièce | Rev. | |
| | 5300ES302008C | 0 | 8/9 |

This drawing is confidential and must not be reproduced or used without the consent of EXM

Ce dessin est confidentiel et ne doit pas être reproduit ou utilisé sans le consentement de EXM

| No. | Revisions | Date | By/Par |
|-----|-----------|------|--------|
| | | | |
| | | | |
| | | | |
| | | | |
| | | | |

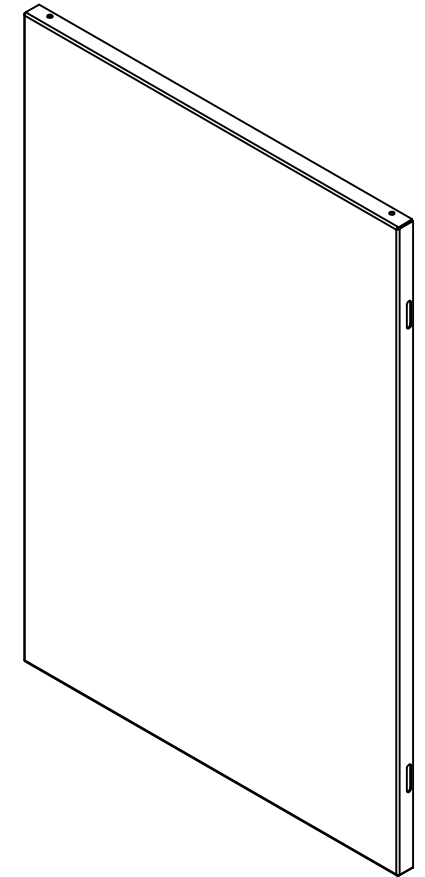

Isometric View

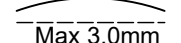
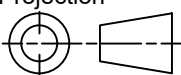

| | | |
|----------------------------------------------------------------------------------------------------------------------------------------------------------------------------------------|-----------------------|-------------------------------------------------------------------------------------------------------------------------------------------------------------------------------------------------------------------------------------|
|  Tél: (450) 979-4373 Fax: (450) 979-4626 www.exmweb.com | | Flatness Aplatissement  Max 3.0mm Projection  |
| Customer Client | Date | |
| Drawn By / Dessiné Par: BoxCad: BoxCad | Date: 10-May-13 | |
| Material / Matière: 16 Ga Cold Rolled A1008 CS Type B (1.4mm) | | |
| Color / Couleur: Asa-61 Grey | Finish / Fini: Smooth | |
| Description: 5300ES 30" x 20" Cover | | Detail Rev. |
| Part Number / Numéro Pièce: 5300ES302008C | | Rev. 0 / 9 |

| Qty | Part Name | Rev | Description |
|------------|-----------------|-----|-----------------------------------------|
| 1 | 5300ES302008G | 0 | 5300ES 30" x 20" Cover Gasket Part |
| 1 | STK-S-00100 | 0 | 3.5" x 2" Silver Milar Flexcon Sticker |
| 1 | STK-Q-16080 | 0 | Ground Stud M6 x 16mm Steel |
| 1 | STK-P-02400S | 0 | Powder Paint (Asa-61 Grey / Smooth) |
| 1 | 5300ES302008C-P | 0 | 5300ES 30" x 20" Cover Part |
| 2 | STK-K-09800 | 10 | 5412 ES Hinge with 2 Captive Hinge Pins |
| Parts List | | | |

This drawing is confidential and must not be reproduced or used without the consent of EXM

Ce dessin est confidentiel et ne doit pas être reproduit ou utilisé sans le consentement de EXM

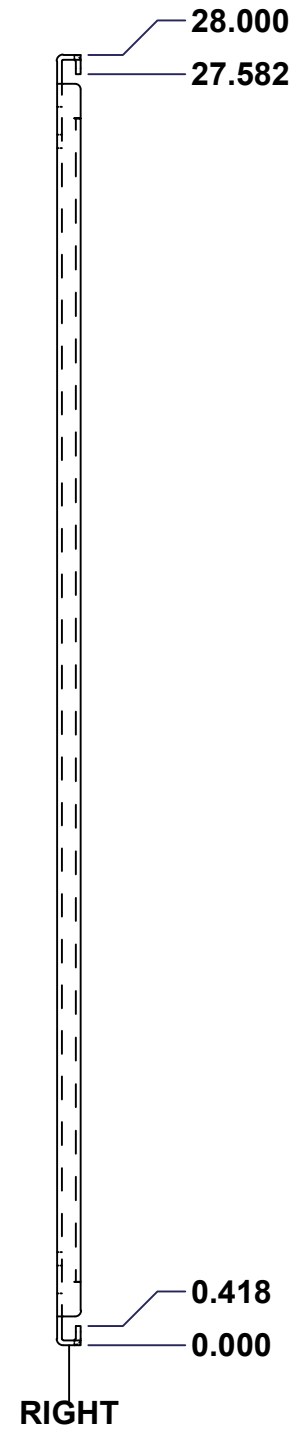
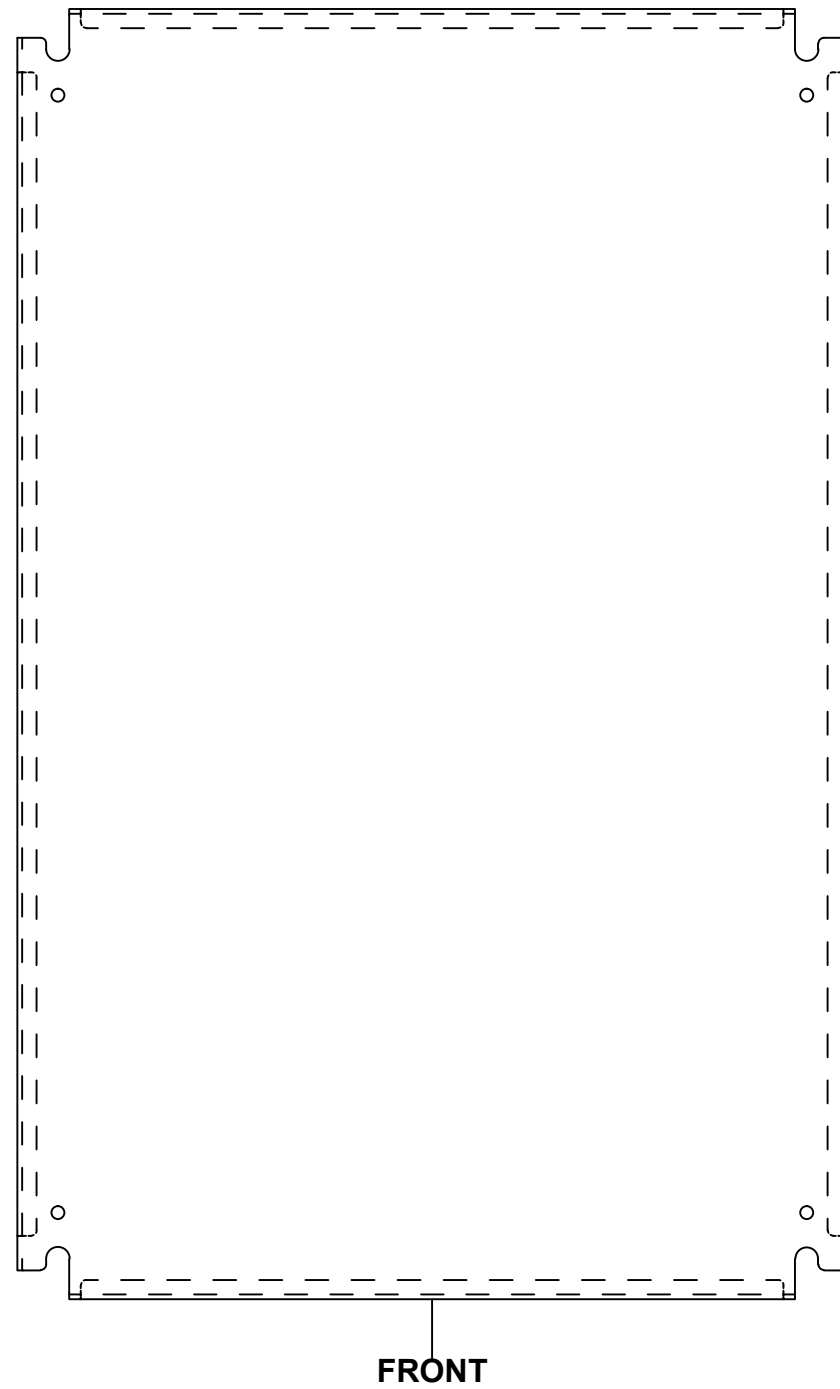
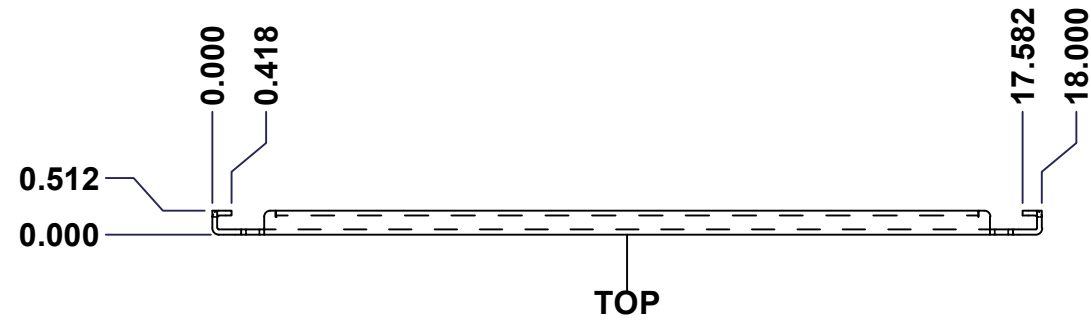

| No. | Revisions | Date | By/Par |
|-----|-----------|------|--------|
| | | | |
| | | | |
| | | | |
| | | | |

Isometric View

| | | |
|--------------------------------------------------------------|---------------------------|------------------------------|
| Tél: (450) 979-4373 Fax: (450) 979-4626 www.exmweb.com | Flatness Aplatissement | Max 3.0mm |
| | Projection | |
| Customer Client | Date | |
| Drawn By Dessiné Par | BoxCad | Date 23-Jan-07 |
| Material Matière | See Part List | |
| Color Couleur | See Part List | Finish Fini See Part List |
| Description | Detail Rev. | |
| 881 SP - Inner Panel | | |
| Part Number Numéro Pièce | Rev. 0 | 1 2 |
| 881 SP3020G | | |

| Qty | Part Number | Rev | Description | Material | Color | Finish |
|-----|---------------|-----|---------------------------|------------------|-----------|------------|
| 1 | 881 SP3020G-P | 0 | 881 SP - Inner Panel Part | 12 Ga Galvanized | Unpainted | Galvanized |

Parts List

This drawing is confidential and must not be reproduced or used without the consent of EXM

Ce dessin est confidentiel et ne doit pas être reproduit ou utilisé sans le consentement de EXM

| Table 1 | | | FRONT VIEW |
|---------|--------|--------|--------------------------|
| CUT-OUT | XDIM | YDIM | DESCRIPTION |
| 1 | 0.875 | 1.875 | GROUND HOLE (RND Ø0.290) |
| 2 | 17.125 | 1.875 | GROUND HOLE (RND Ø0.290) |
| 3 | 0.875 | 26.125 | GROUND HOLE (RND Ø0.290) |
| 4 | 17.125 | 26.125 | GROUND HOLE (RND Ø0.290) |

All knockouts are actual size / Les disques défonçables sont grandeur réel

| No. | Revisions | Date | By/Par |
|-----|-----------|------|--------|
| | | | |
| | | | |
| | | | |
| | | | |
| | | | |
| | | | |

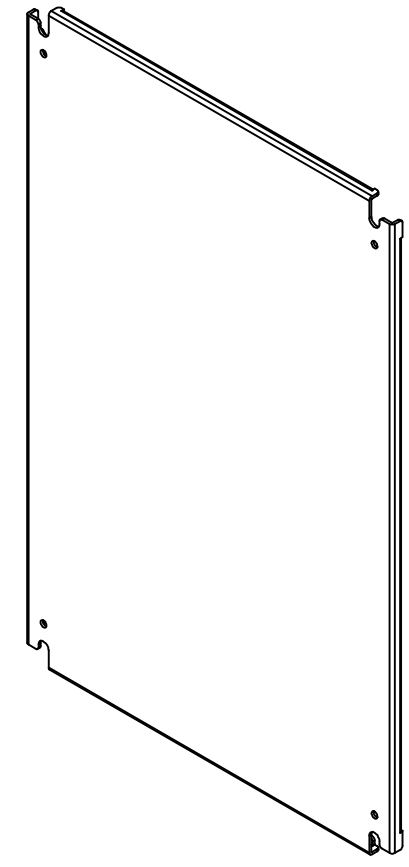
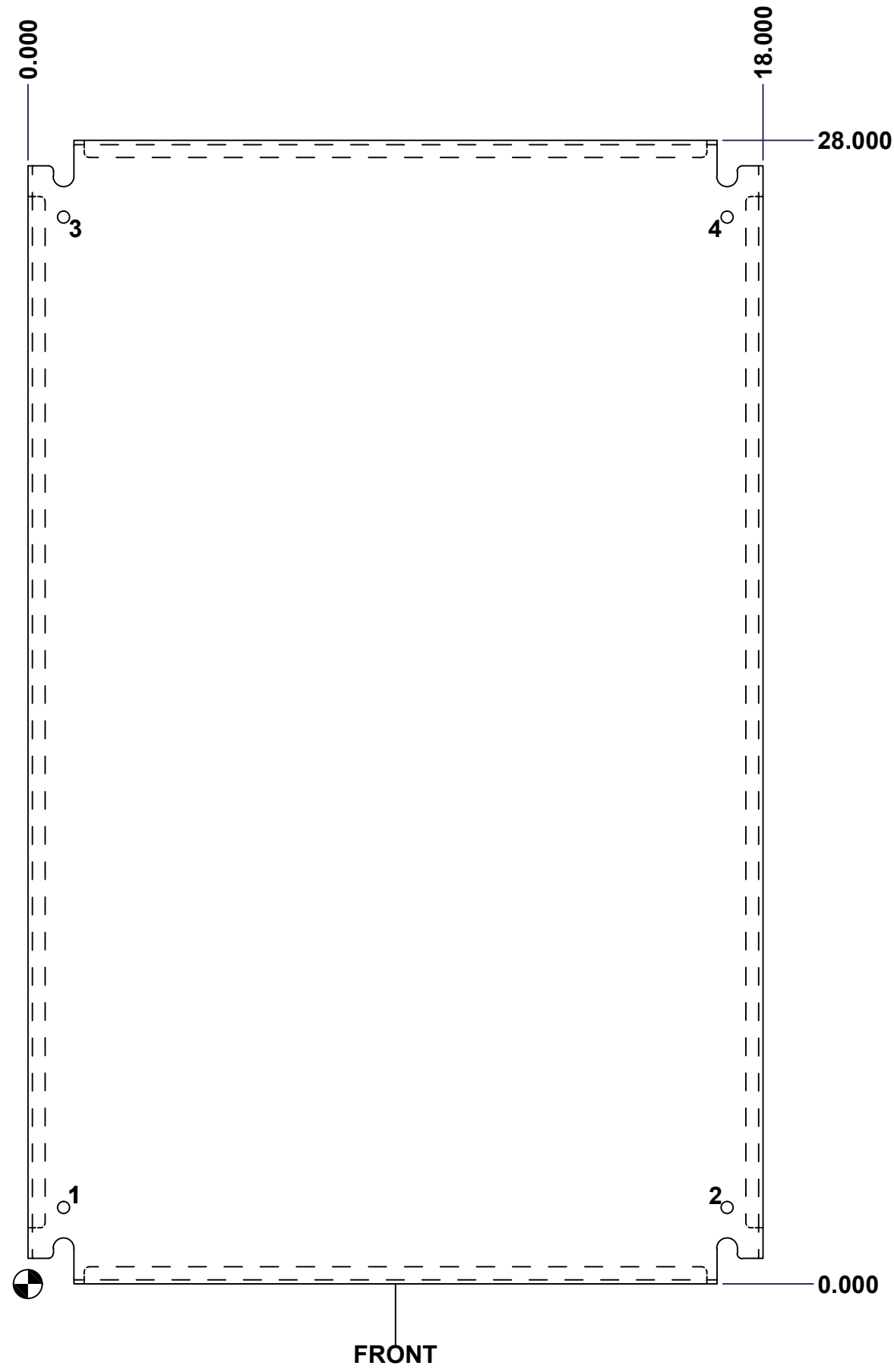

Isometric View

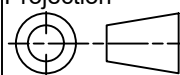

| | |
|----------------------------------------------------------------------------------------------------------------------------------------------------|-----------------------------------------------------------------------------------------------------|
|  Tél: (450) 979-4373 Fax: (450) 979-4626 www.exmweb.com | Flatness Aplatissement Max 3.0mm |
| | Projection  |
| Customer Client | Date |
| Drawn By Dessiné Par BoxCad | Date 23-Jan-07 |
| Material Matière | See Part List |
| Color Couleur | See Part List |
| Finish Fini | See Part List |
| Description 881 SP - Inner Panel | Detail Rev. |
| Part Number Numéro Pièce 881 SP3020G | Rev. 0 |

2
2