

This drawing is confidential and must not be reproduced or used without the consent of EXM

Ce dessin est confidentiel et ne doit pas être reproduit ou utilisé sans le consentement de EXM

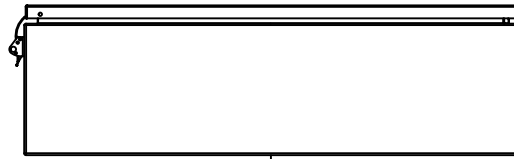

TOP

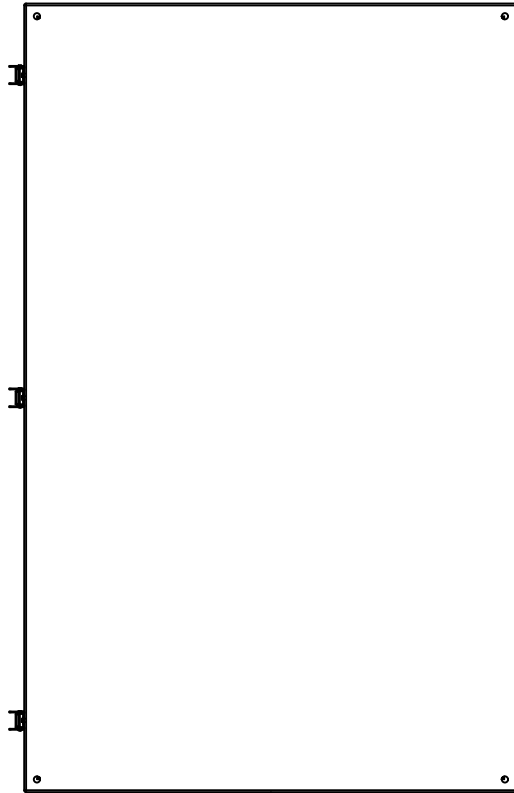

BACK

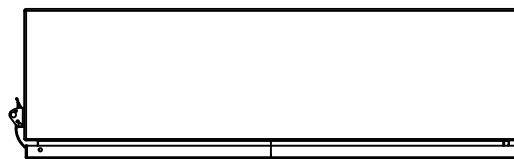

BOTTOM

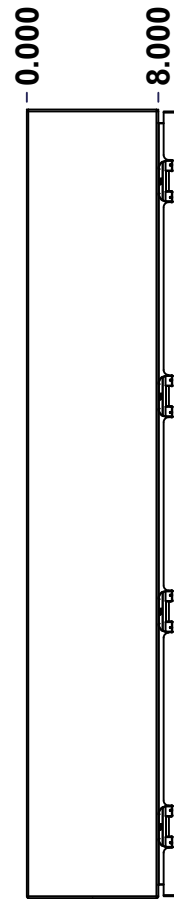

LEFT

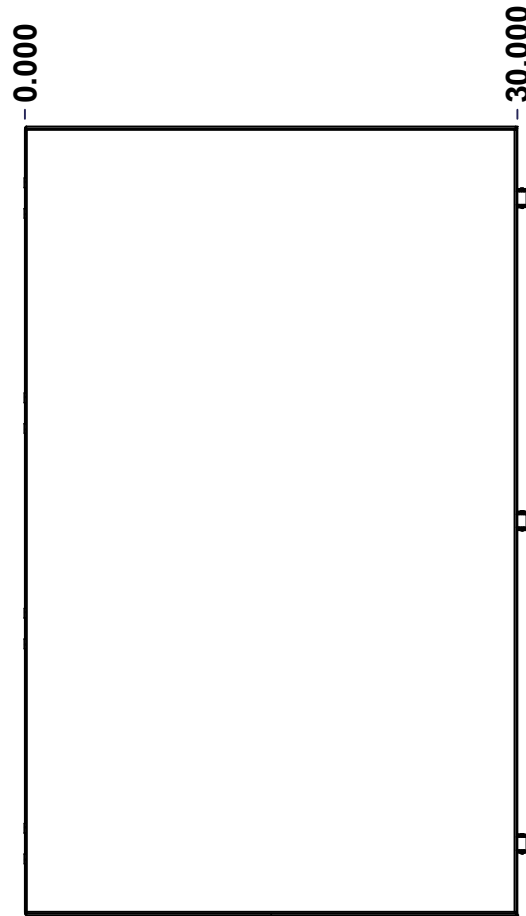

FRONT

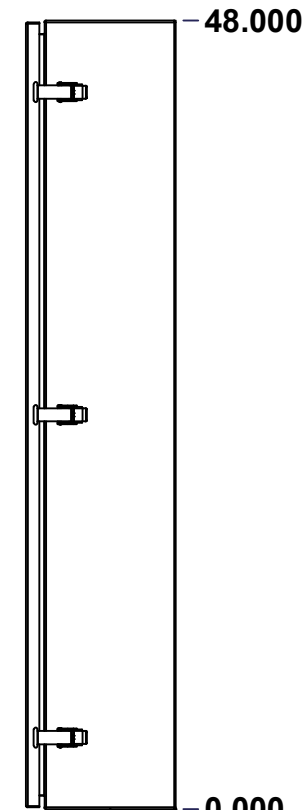

RIGHT

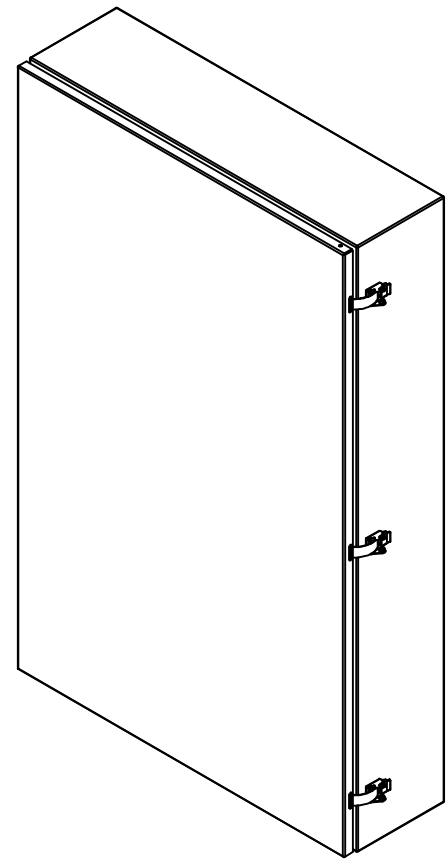

Isometric View

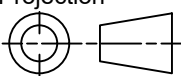

No.	Revisions	Date	By/Par

 Tél: (450) 979-4373 Fax: (450) 979-4626 www.exmweb.com		Flatness Aplatissement Max 3.0mm Projection 
Customer Client	Date	
Drawn By Dessiné Par	BoxCad: BoxCad	Date 10-May-13
Material Matière	14 Ga Cold Rolled A1008 CS Type B (1.7mm)	
Color Couleur	Asa-61 Grey	Finish Fini Smooth
Description 5300ES 48" x 30" x 8" Assembly		Detail Rev.
Part Number Numéro Pièce	Rev. 0	1 9

SEE BILL OF MATERIAL ON LAST PAGE

5300ES483008

This drawing is confidential and must not be reproduced or used without the consent of EXM

Ce dessin est confidentiel et ne doit pas être reproduit ou utilisé sans le consentement de EXM

NOTE	
ITEM	DESCRIPTION
1	NEMA 3/3R Enclosure
2	C/W Standard ground studs on box and cover
3	W/O Standard door stiffener
4	C/W Standard inner panel (Included)
5	C/W Standard inner panel mounting studs
6	C/W 880 PP included (Not installed)

No.	Revisions	Date	By/Par

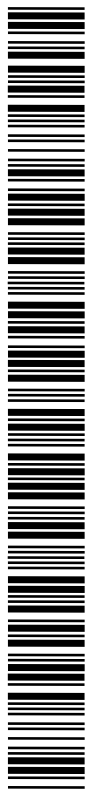
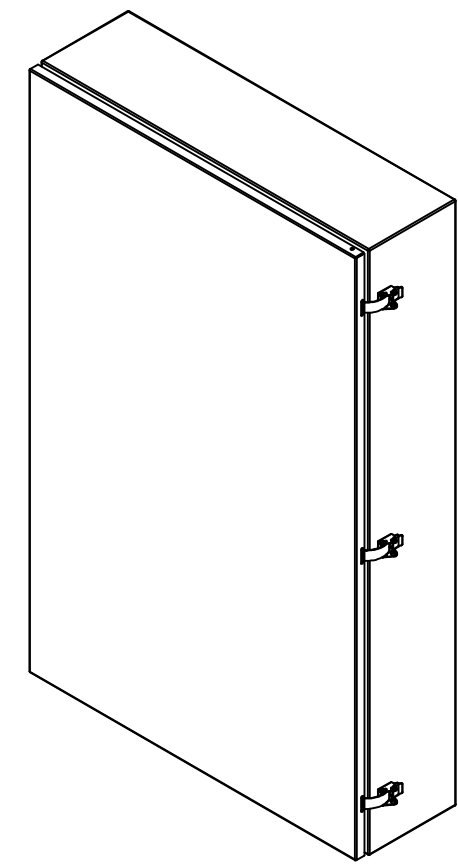

Isometric View

 Tél: (450) 979-4373
 Fax: (450) 979-4626
www.exmweb.com

Flatness
 Aplatissement
 Max 3.0mm
 Projection

Customer Client	Date
Drawn By Dessiné Par	Date 10-May-13

Material Matière 14 Ga Cold Rolled A1008 CS Type B (1.7mm)

Color Couleur Asa-61 Grey Finish Fini Smooth

Description 5300ES 48" x 30" x 8" Assembly Detail Rev.

Part Number Numéro Pièce **5300ES483008** Rev. **0** 2/9

PACKING		
ITEM	QTY	DESCRIPTION
Cardboard sleeve	2	Top and Bottom
Cardboard strip	2	Between back of enclosure and inner panel
Plastic bag	1	To protect cover surface and inside gasket
Cardboard corner	4	To reinforced for the plastic strap tightening
Plastic strap - Black	2	To Squeeze the 2 cardboard sleeve together
Packaging label	3	White label with PN
Plastic strap- Green	2	To secure the enclosure to the wood pallet
Wood Pallet	1	2" deeper and 3" larger than enclosure size

Qty	Part Number	Rev	Description
1	881 SP4830G	0	881 SP - Inner Panel
3	STK-K-01320	0	5412 ES Inner Panel Accessory Kit
1	880 PP	6	Self Adhesive Print Pocket
1	STK-K-03000	1	5100 ES Accessory Kit
1	5300ES483008C	0	5300ES 48" x 30" Cover
1	5300ES483008B	0	5300ES 48" x 30" x 8" Body
3	STK-K-11910	3	Stainless Steel Draw Pull Latch (Long)
4	STK-Q-04050-08	0	M6 x 8mm Hexagon Socket Head Machine Screw
Parts List			

This drawing is confidential and must not be reproduced or used without the consent of EXM

Ce dessin est confidentiel et ne doit pas être reproduit ou utilisé sans le consentement de EXM

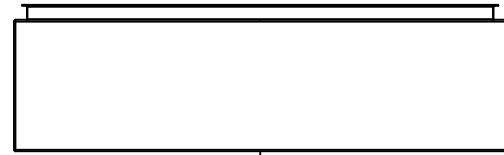

TOP

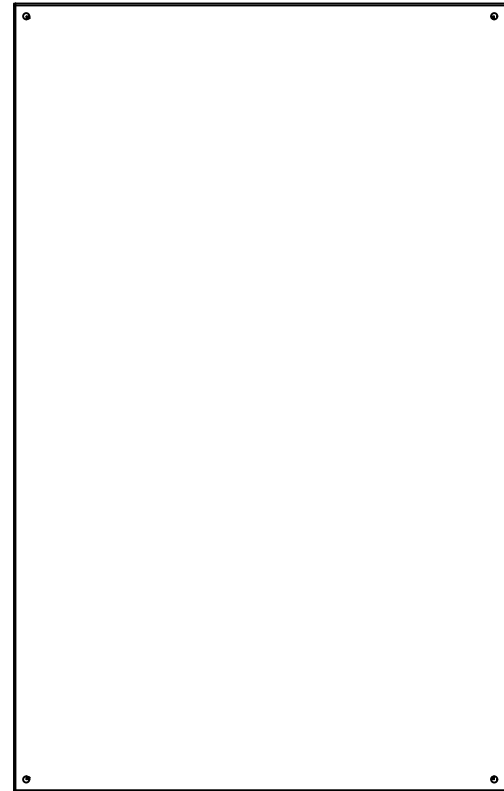

BACK

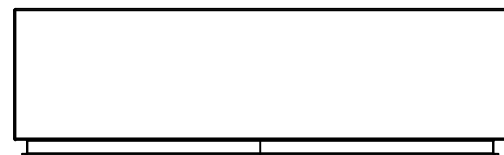

BOTTOM

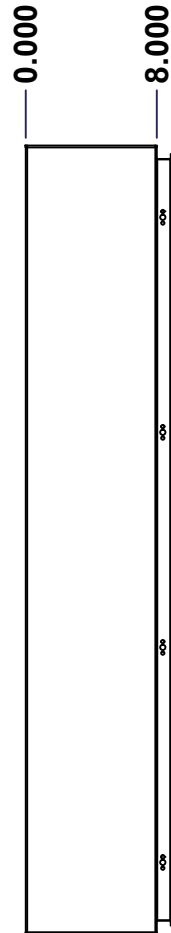

LEFT

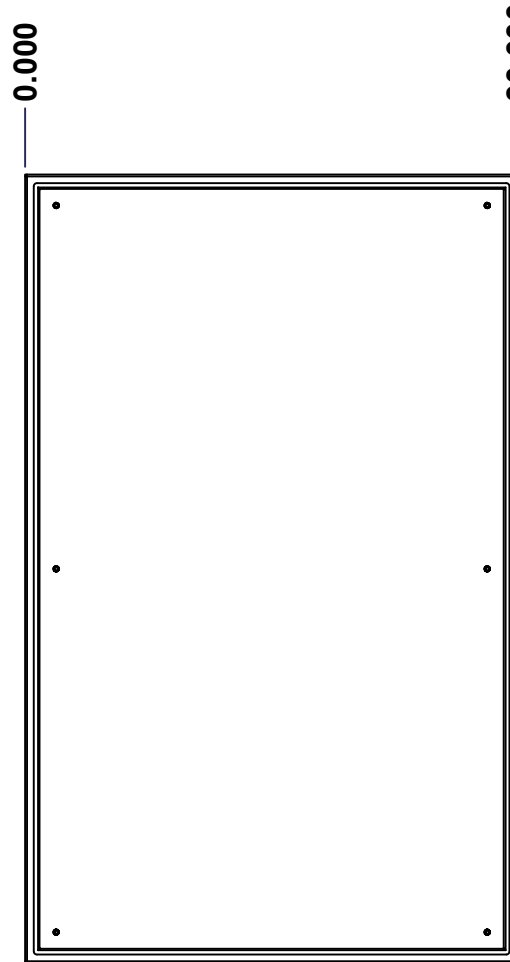

FRONT

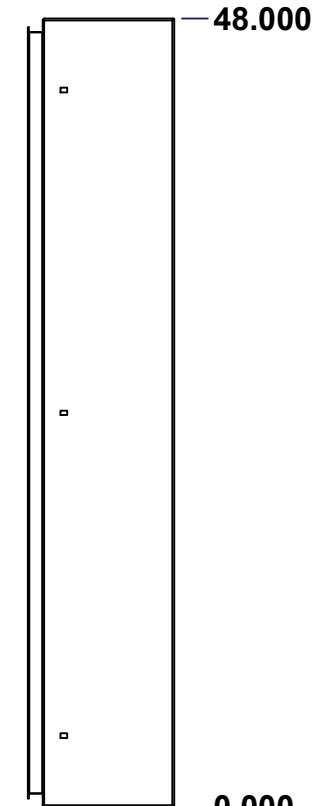

RIGHT

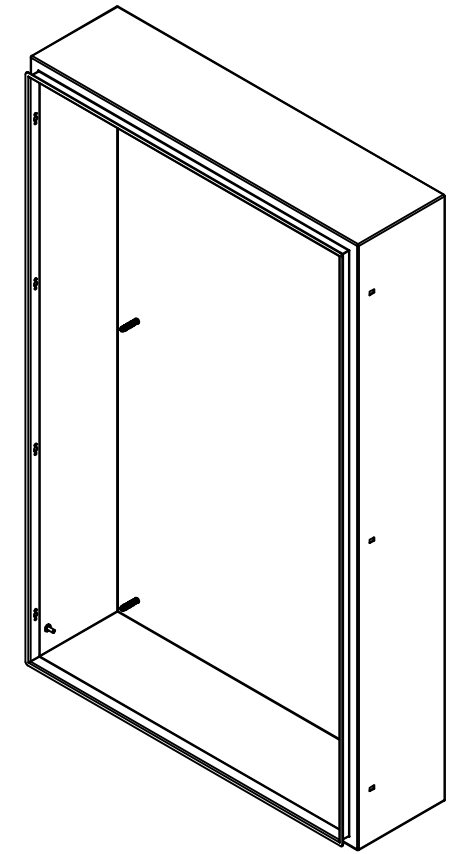

Isometric View

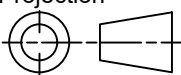

No.	Revisions	Date	By/Par

 Tél: (450) 979-4373 Fax: (450) 979-4626 www.exmweb.com		Flatness Aplatissement Max 3.0mm Projection 
Customer Client	Date	
Drawn By Dessiné Par	BoxCad: BoxCad	Date 10-May-13
Material Matière	14 Ga Cold Rolled A1008 CS Type B (1.7mm)	
Color Couleur	Asa-61 Grey	Finish Fini Smooth
Description	Detail Rev.	
5300ES 48" x 30" x 8" Body		
Part Number Numéro Pièce	Rev. 0	3 9

SEE BILL OF MATERIAL ON LAST PAGE

5300ES483008B

This drawing is confidential and must not be reproduced or used without the consent of EXM

Ce dessin est confidentiel et ne doit pas être reproduit ou utilisé sans le consentement de EXM

STANDARD FEATURES ARE NOT LISTED IN THIS HOLE TABLE			
HOLE TABLE - LEFT VIEW (CUSTOM FEATURE ONLY)			
CUT-OUT	XDIM	YDIM	DESCRIPTION
1	6.500	2.000	GND STUD M6 x 16mm (Inside)

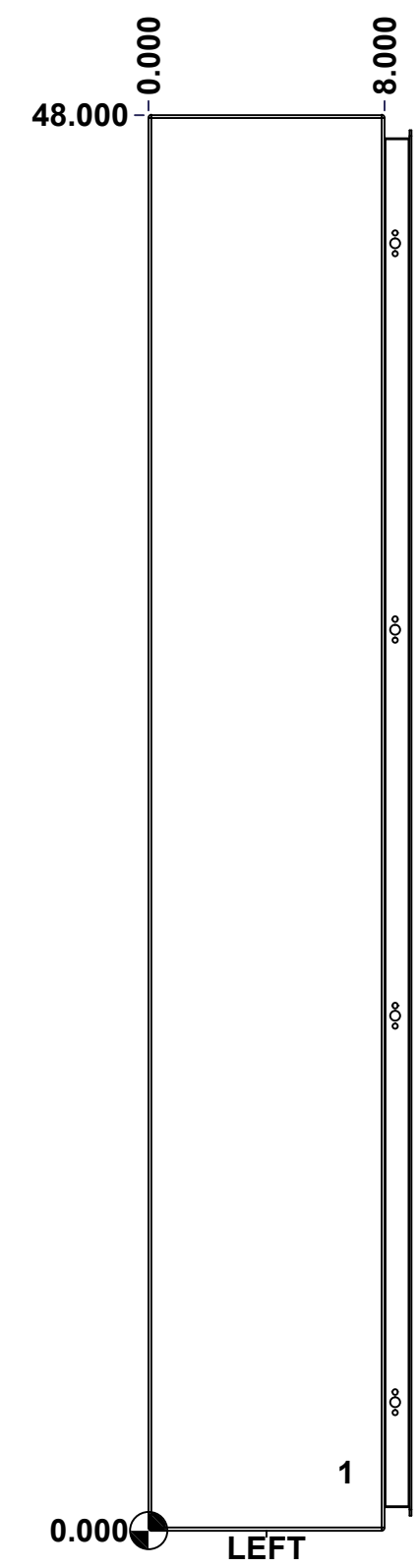

	Description	Status	
	5300ES 48" x 30" x 8" Body	(NULL)	
	Part Number Numéro Pièce	Rev.	
	5300ES483008B	0	4 9

This drawing is confidential and must not be reproduced or used without the consent of EXM

Ce dessin est confidentiel et ne doit pas être reproduit ou utilisé sans le consentement de EXM

STANDARD FEATURES ARE NOT LISTED IN THIS HOLE TABLE

HOLE TABLE - BACK VIEW (CUSTOM FEATURE ONLY)

CUT-OUT	XDIM	YDIM	DESCRIPTION
1	1.875	1.875	IP STUD M8 x 35mm (Inside)
2	1.875	46.125	IP STUD M8 x 35mm (Inside)
3	28.125	46.125	IP STUD M8 x 35mm (Inside)
4	28.125	1.875	IP STUD M8 x 35mm (Inside)
5	1.875	24.000	IP STUD M8 x 35mm (Inside)
6	28.125	24.000	IP STUD M8 x 35mm (Inside)

7	29.250	0.750	RND Ø0.390
8	29.250	47.250	RND Ø0.390
9	0.750	47.250	RND Ø0.390
10	0.750	0.750	RND Ø0.390

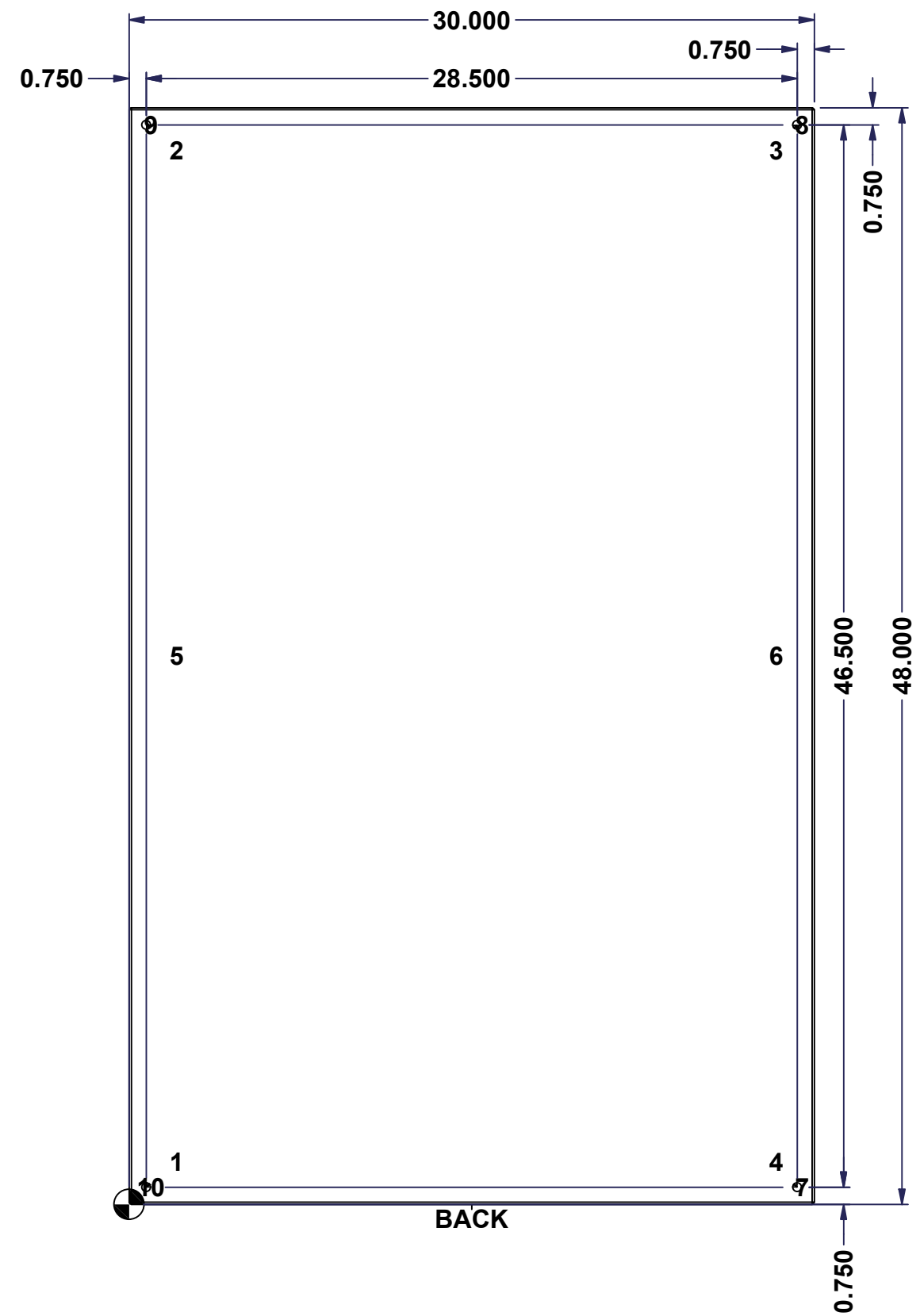

	Description	Status
	5300ES 48" x 30" x 8" Body	(NULL)
	Part Number	Rev.
	Numéro Pièce	5
	5300ES483008B	0
		9

This drawing is confidential and must not be reproduced or used without the consent of EXM

Ce dessin est confidentiel et ne doit pas être reproduit ou utilisé sans le consentement de EXM

No.	Revisions	Date	By/Par

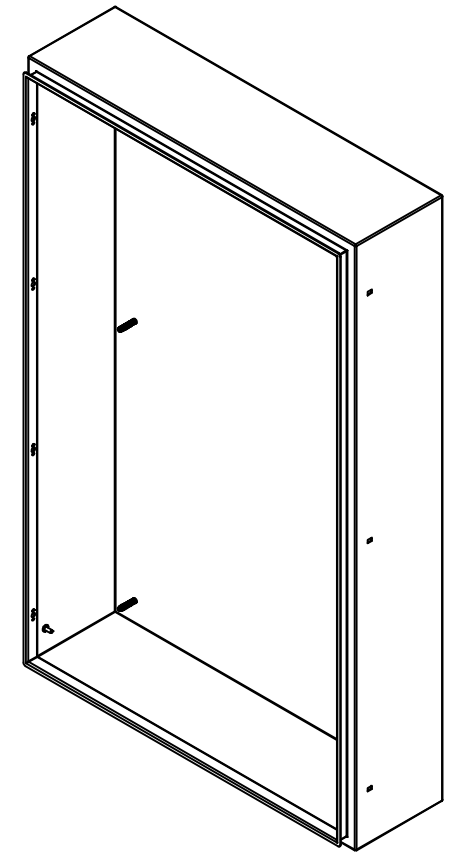

Isometric View

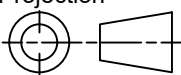

 Tél: (450) 979-4373 Fax: (450) 979-4626 www.exmweb.com		Flatness Aplatissement Max 3.0mm Projection 
Customer Client	Date	
Drawn By Dessiné Par	BoxCad: BoxCad	Date 10-May-13
Material Matière	14 Ga Cold Rolled A1008 CS Type B (1.7mm)	
Color Couleur	Asa-61 Grey	Finish Fini Smooth
Description		Detail Rev.
5300ES 48" x 30" x 8" Body		
Part Number Numéro Pièce	Rev.	6
5300ES483008B	0	9

Qty	Part Number	Rev	Description
1	STK-Q-16080	0	Ground Stud M6 x 16mm Steel
1	STK-P-02400S	0	Powder Paint (Asa-61 Grey / Smooth)
6	STK-Q-16005	1	Stud M8 x 35 (No Paint Cap Required)
1	5300ES483008B-P	0	5300ES 48" x 30" x 8" Body Part
Parts List			

This drawing is confidential and must not be reproduced or used without the consent of EXM

Ce dessin est confidentiel et ne doit pas être reproduit ou utilisé sans le consentement de EXM

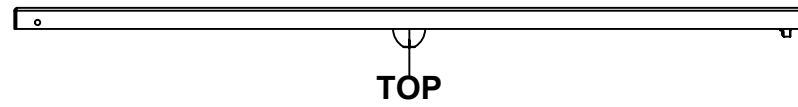

TOP

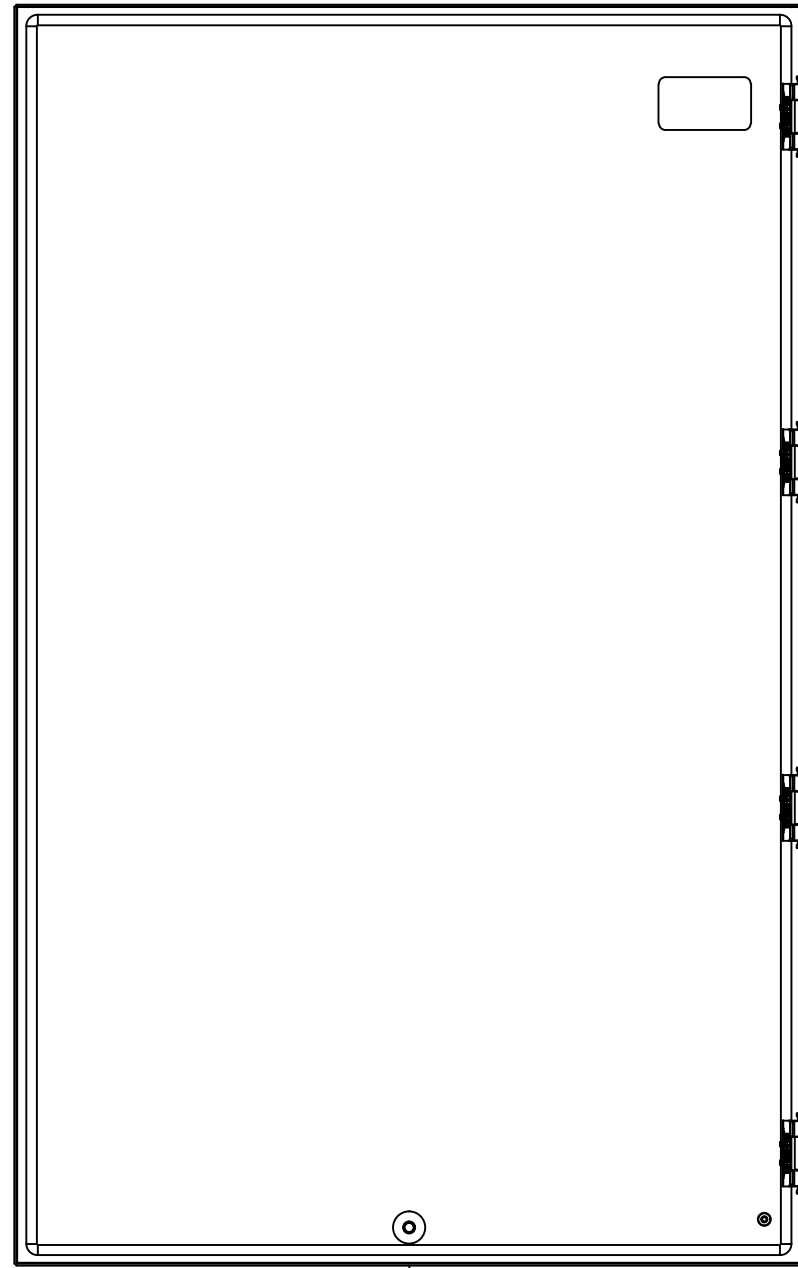

BACK



BOTTOM

0.000
0.800

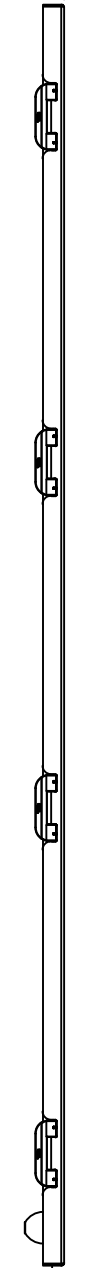

LEFT

0.000
29.918

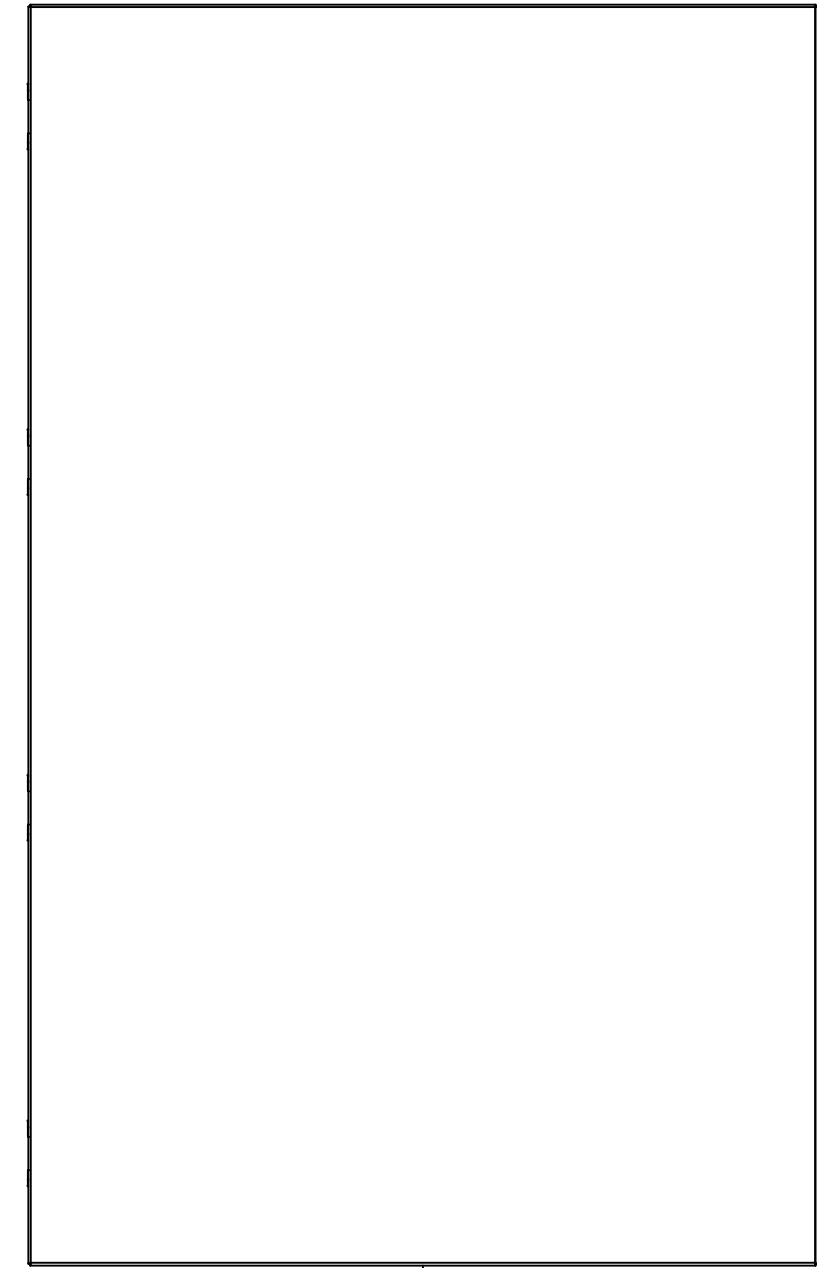

FRONT

47.803

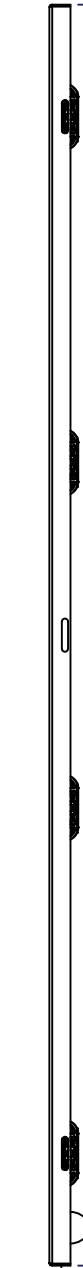

RIGHT

0.000

No.	Revisions	Date	By/Par

Isometric View

<p>Tél: (450) 979-4373 Fax: (450) 979-4626 www.exmweb.com</p>		Flatness Aplatissement
		Max 3.0mm
		Projection
Customer Client		Date
Drawn By Dessiné Par	BoxCad: BoxCad	Date 10-May-13
Material Matière	14 Ga Cold Rolled A1008 CS Type B (1.7mm)	
Color Couleur	Asa-61 Grey	Finish Fini Smooth
Description	Detail Rev.	
5300ES 48" x 30" Cover		
Part Number Numéro Pièce	Rev.	
5300ES483008C	0	7 9

SEE BILL OF MATERIAL ON LAST PAGE

This drawing is confidential and must not be reproduced or used without the consent of EXM

Ce dessin est confidentiel et ne doit pas être reproduit ou utilisé sans le consentement de EXM

STANDARD FEATURES ARE NOT LISTED IN THIS HOLE TABLE			
HOLE TABLE - FRONT VIEW (CUSTOM FEATURE ONLY)			
CUT-OUT	XDIM	YDIM	DESCRIPTION
1	14.959	1.435	STUD M6 x 18mm (Inside)

2	1.486	1.756	GND STUD M6 x 16mm (Inside)
3	3.750	44.053	LABEL_EXM (Inside)

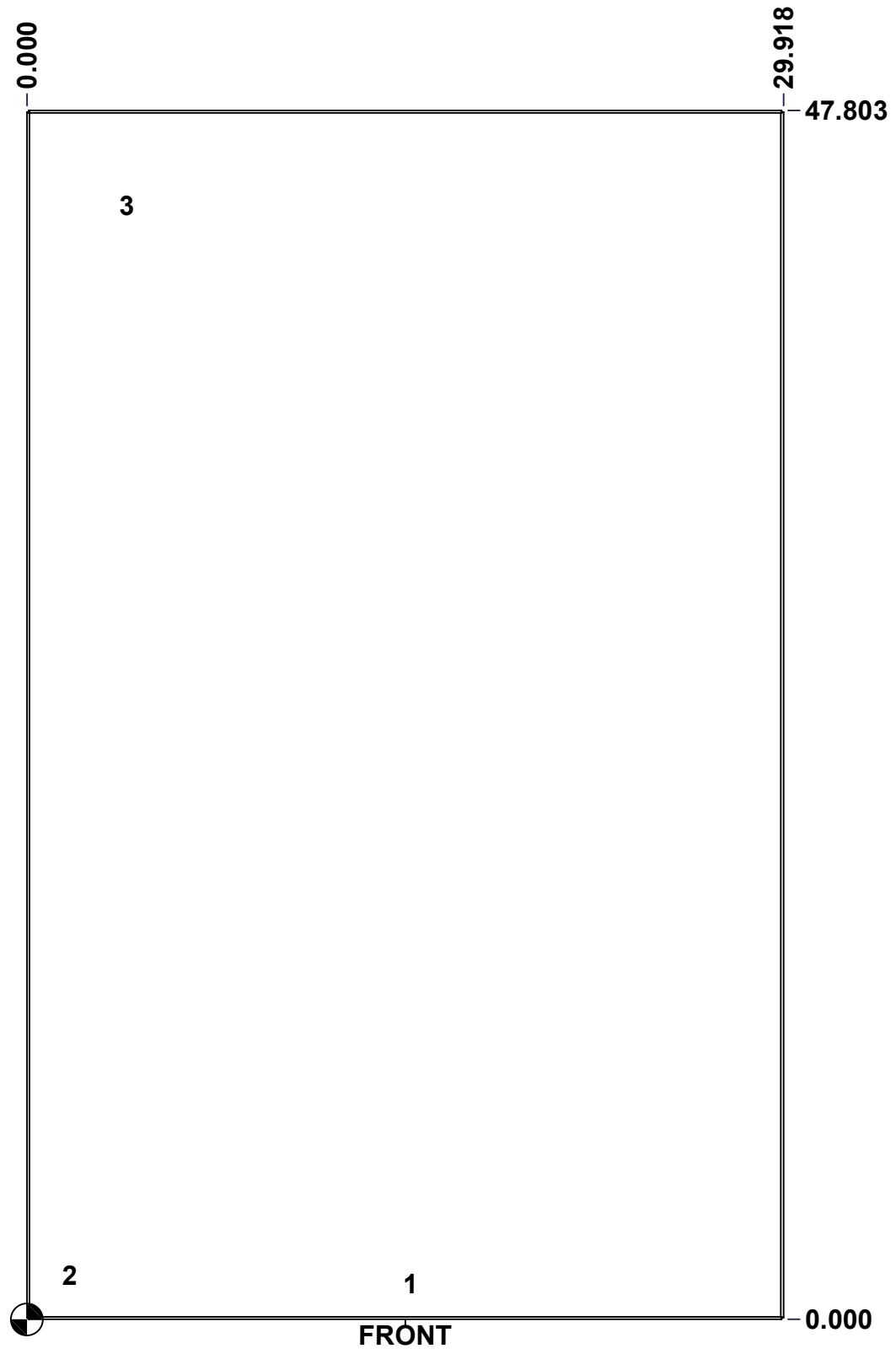

	Description	Status
	5300ES 48" x 30" Cover	(NULL)
	Part Number Numéro Pièce	Rev.
	5300ES483008C	0 / 8 / 9

This drawing is confidential and must not be reproduced or used without the consent of EXM

Ce dessin est confidentiel et ne doit pas être reproduit ou utilisé sans le consentement de EXM

No.	Revisions	Date	By/Par

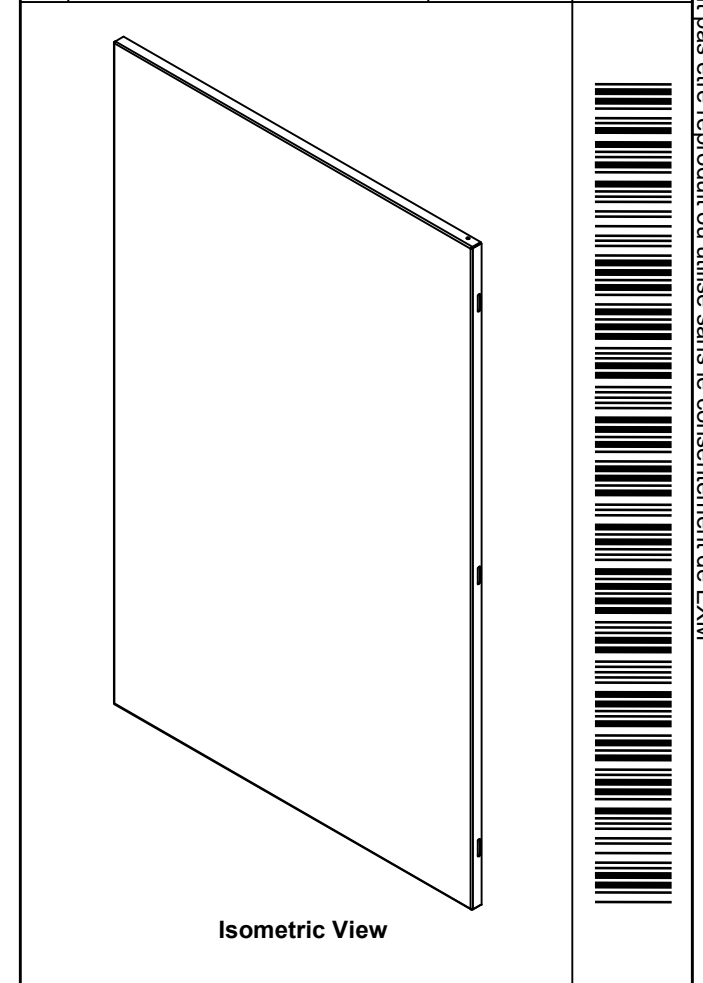

 Tél: (450) 979-4373
 Fax: (450) 979-4626
www.exmweb.com

Flatness
 Aplatissement
 Max 3.0mm
Projection

Customer Client	Date
Drawn By / Dessiné Par: BoxCad: BoxCad	Date: 10-May-13

Material / Matière	14 Ga Cold Rolled A1008 CS Type B (1.7mm)
--------------------	---

Color / Couleur: Asa-61 Grey	Finish / Fini: Smooth
------------------------------	-----------------------

Description: 5300ES 48" x 30" Cover	Detail Rev.
-------------------------------------	-------------

Part Number / Numéro Pièce: 5300ES483008C	Rev. 0	9
--	--------	---

Qty	Part Name	Rev	Description
1	STK-S-00100	0	3.5" x 2" Silver Milar Flexcon Sticker
1	STK-Q-16080	0	Ground Stud M6 x 16mm Steel
1	STK-P-02400S	0	Powder Paint (Asa-61 Grey / Smooth)
1	5300ES483008G	0	5300ES 48" x 30" Cover Gasket Part
1	STK-Q-46515	3	5412 ES Door Support with Brass Insert
1	STK-Q-16055	1	M6 x 18mm Stud (No Paint Cap Required)
1	5300ES483008C-P	0	5300ES 48" x 30" Cover Part
4	STK-K-09800	10	5412 ES Hinge with 2 Captive Hinge Pins
Parts List			

This drawing is confidential and must not be reproduced or used without the consent of EXM

Ce dessin est confidentiel et ne doit pas être reproduit ou utilisé sans le consentement de EXM

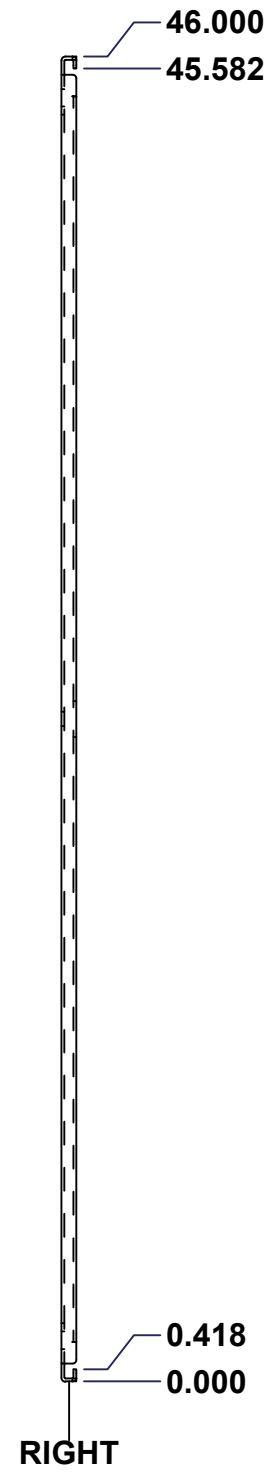
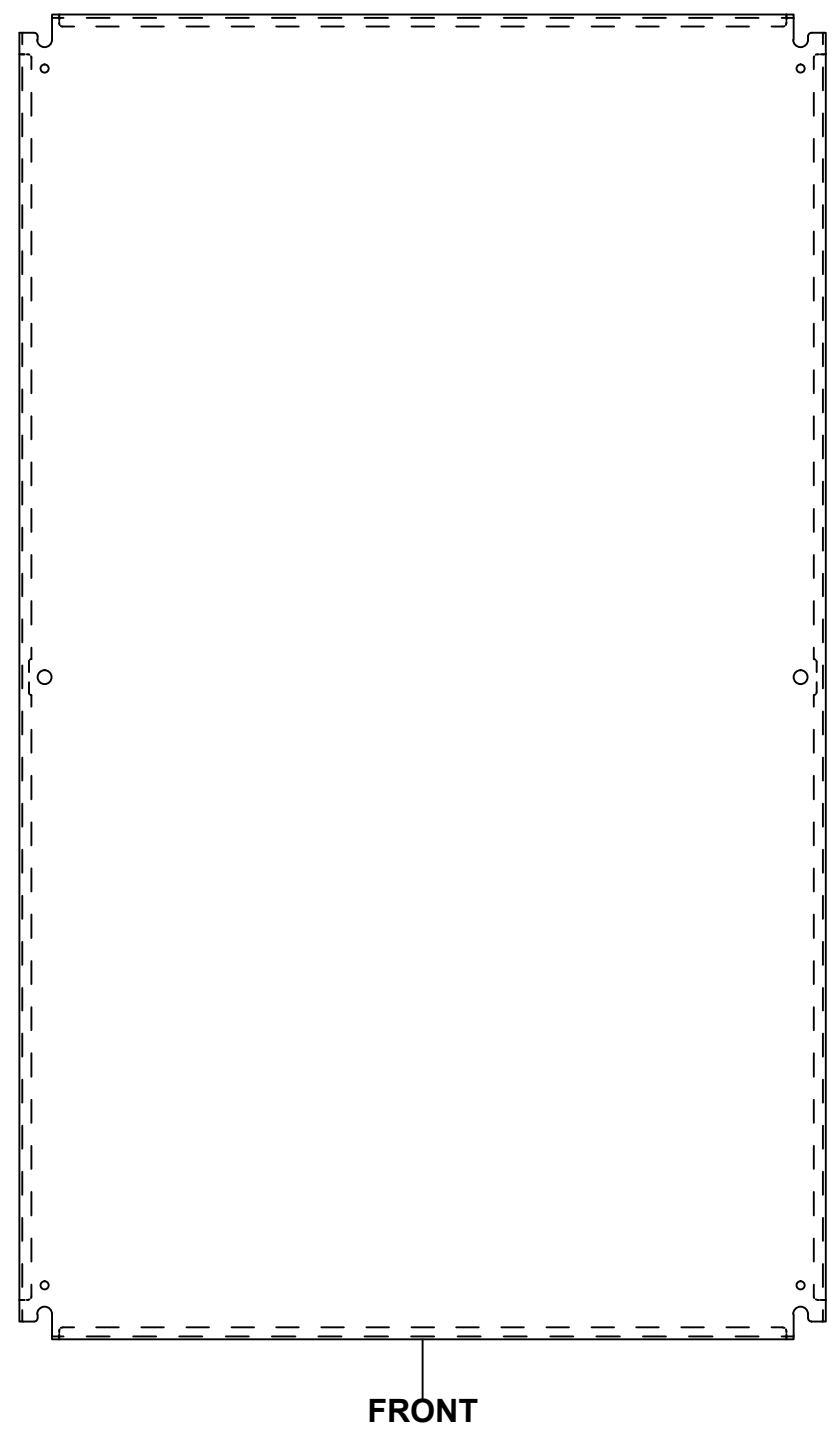
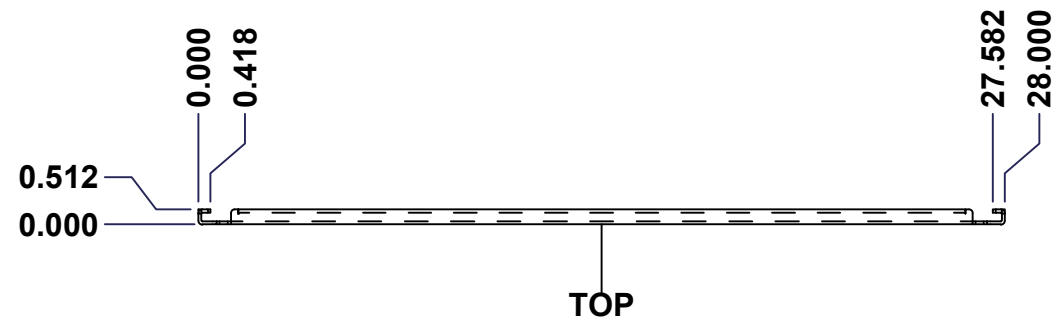

No.	Revisions	Date	By/Par

Isometric View

Tél: (450) 979-4373 Fax: (450) 979-4626 www.exmweb.com	Flatness Aplatissement
	Max 3.0mm
Projection	
Customer Client	Date
Drawn By Dessiné Par BoxCad	Date 23-Jan-07
Material Matière	See Part List
Color Couleur	See Part List
Finish Fini	See Part List
Description	Detail Rev.
881 SP - Inner Panel	
Part Number Numéro Pièce	Rev. 1
881 SP4830G	0 2

Qty	Part Number	Rev	Description	Material	Color	Finish
1	881 SP4830G-P	0	881 SP - Inner Panel Part	12 Ga Galvanized	Unpainted	Galvanized

Parts List

This drawing is confidential and must not be reproduced or used without the consent of EXM

Ce dessin est confidentiel et ne doit pas être reproduit ou utilisé sans le consentement de EXM

Table 1			FRONT VIEW
CUT-OUT	XDIM	YDIM	DESCRIPTION
1	0.875	1.875	GROUND HOLE (RND Ø0.290)
2	27.125	1.875	GROUND HOLE (RND Ø0.290)
3	0.875	44.125	GROUND HOLE (RND Ø0.290)
4	27.125	44.125	GROUND HOLE (RND Ø0.290)
5	0.875	23.000	MTG STUD HOLE (RND Ø0.500)
6	27.125	23.000	MTG STUD HOLE (RND Ø0.500)

All knockouts are actual size / Les disques défonçables sont grandeur réel

No.	Revisions	Date	By/Par

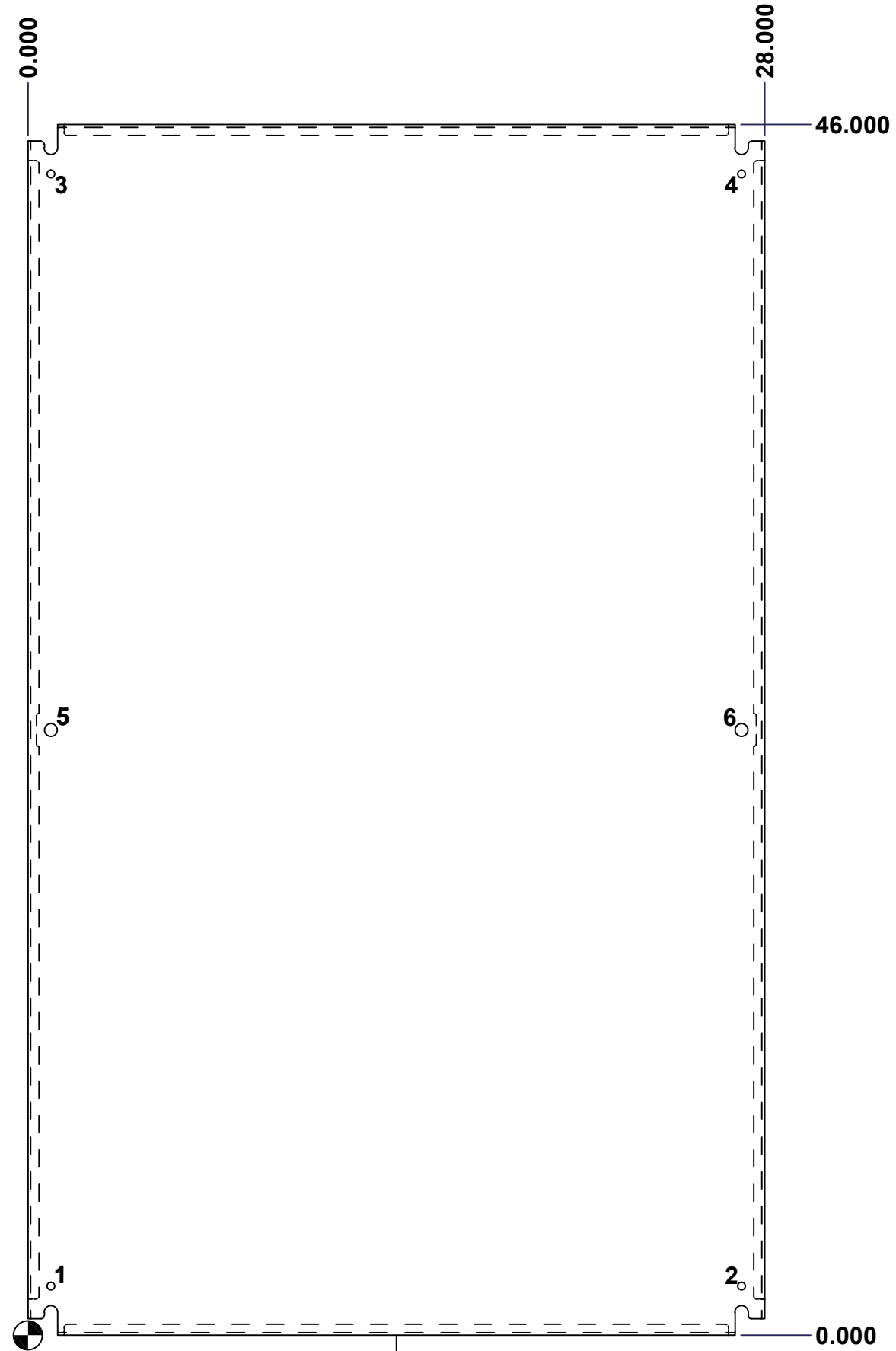

FRONT

Isometric View

		Tél: (450) 979-4373 Fax: (450) 979-4626 www.exmweb.com	Flatness Aplatissement Max 3.0mm Projection
Customer Client			Date
Drawn By Dessiné Par	BoxCad	Date 23-Jan-07	
Material Matière	See Part List		
Color Couleur	See Part List	Finish Fini	See Part List
Description	881 SP - Inner Panel		Detail Rev.
Part Number Numéro Pièce	881 SP4830G		Rev. 2 0