

This drawing is confidential and must not be reproduced or used without the consent of EXM

Ce dessin est confidentiel et ne doit pas être reproduit ou utilisé sans le consentement de EXM

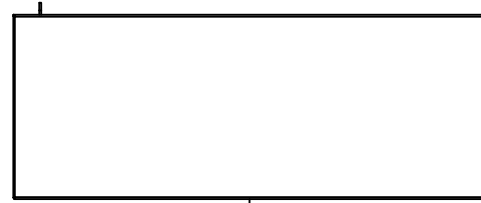

TOP

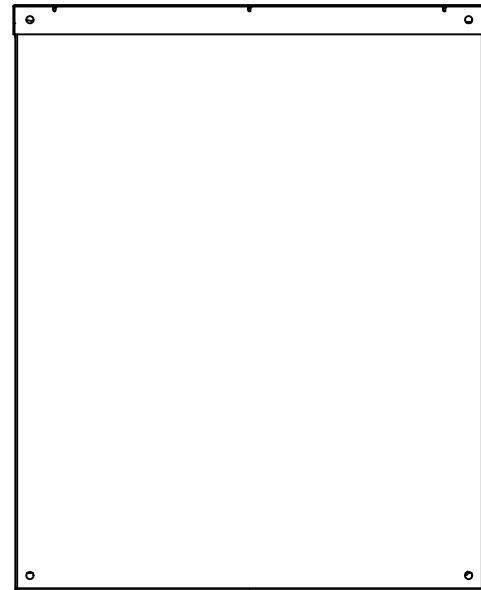

BACK

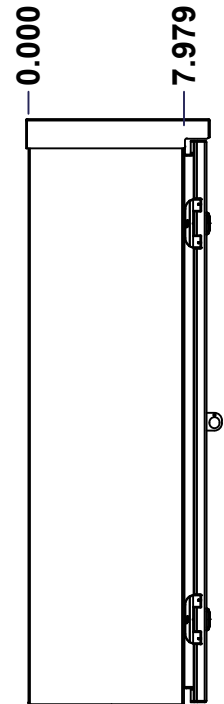

LEFT

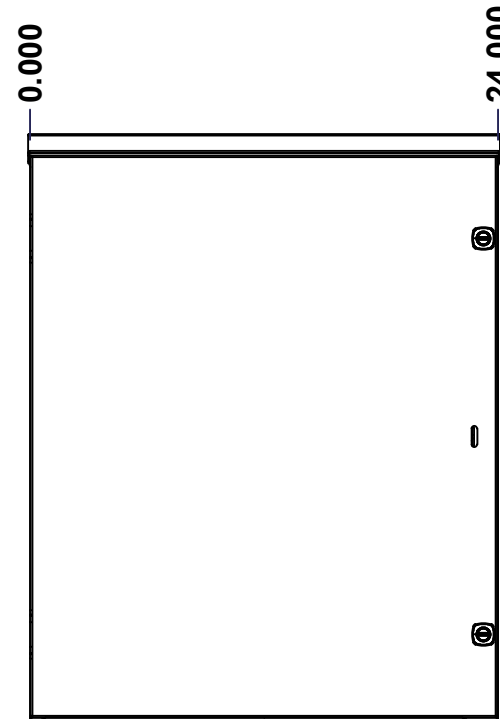

FRONT

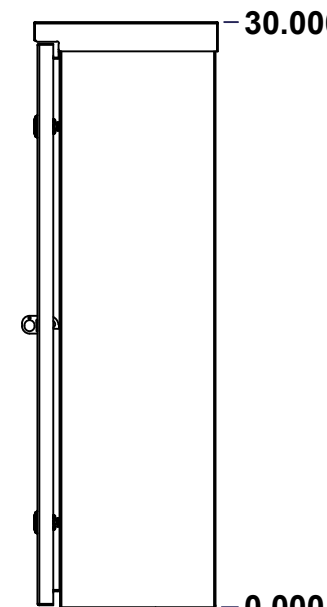

RIGHT

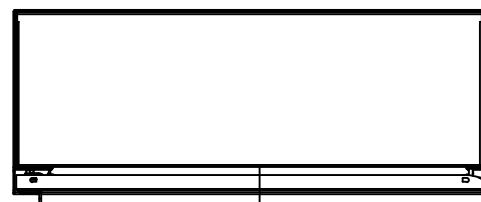

BOTTOM

No.	Revisions	Date	By/Par

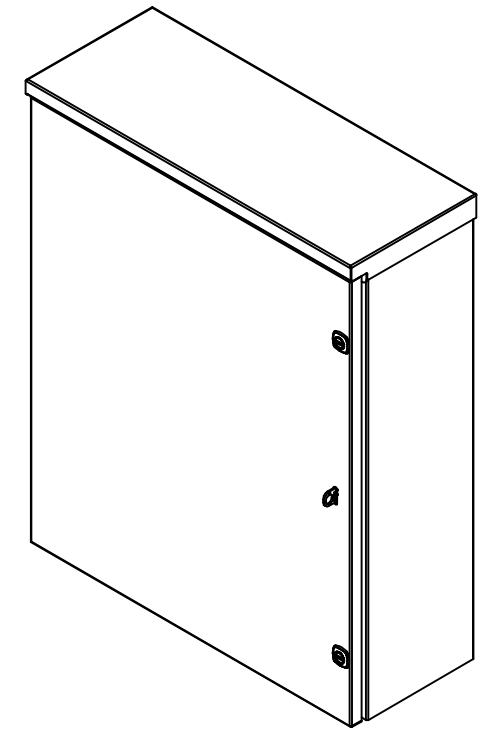

Isometric View



Tél: (450) 979-4373
 Fax: (450) 979-4626
www.exmweb.com

Flatness
Aplatissement

Max 3.0mm

Projection

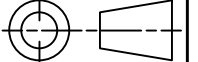

Customer Client	Date
Drawn By / Dessiné Par: BoxCad: BoxCad	Date: 01-Feb-22
Material Matière: 16 Ga Galvanized (1.4mm)	
Color Couleur: Asa-61 Grey	Finish Fini: Smooth

Description: 5300ESG 30" x 24" x 8" Assembly	Detail Rev.
--	-------------

Part Number / Numéro Pièce: 5300ESG302408	Rev. 0	1 / 10
---	--------	--------

SEE BILL OF MATERIAL ON LAST PAGE

This drawing is confidential and must not be reproduced or used without the consent of EXM

Ce dessin est confidentiel et ne doit pas être reproduit ou utilisé sans le consentement de EXM

NOTE	
ITEM	DESCRIPTION
1	NEMA 3/3R Enclosure
2	C/W Standard ground studs on box and cover
3	W/O Standard door stiffener
4	W/O Inner panel
5	C/W Standard inner panel mounting studs
6	C/W Padlock sold separately (Kit)

No.	Revisions	Date	By/Par

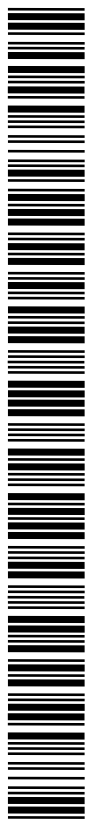
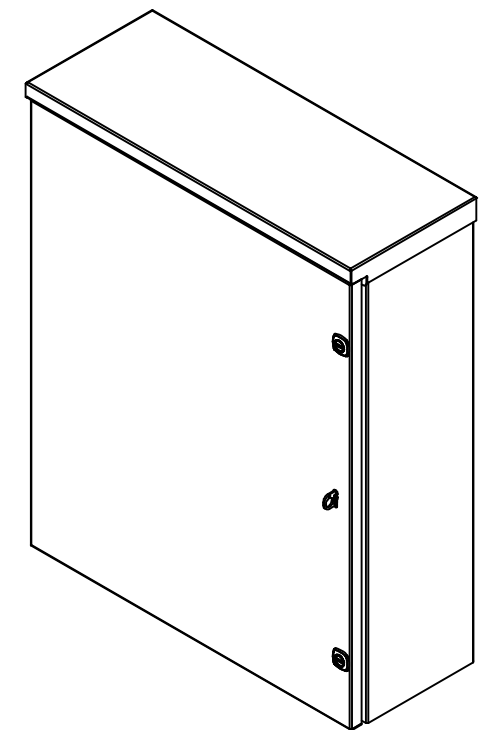

Isometric View



Tél: (450) 979-4373
 Fax: (450) 979-4626
www.exmweb.com

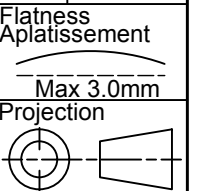

Customer Client	Date
Drawn By / Dessiné Par: BoxCad: BoxCad	Date: 01-Feb-22
Material / Matière: 16 Ga Galvanized (1.4mm)	

Color / Couleur: Asa-61 Grey	Finish / Fini: Smooth
------------------------------	-----------------------

Description: 5300ESG 30" x 24" x 8" Assembly	Detail Rev.
--	-------------

Part Number / Numéro Pièce: 5300ESG302408	Rev. / Révis: 0	2 / 10
--	------------------------	--------

PACKING		
ITEM	QTY	DESCRIPTION
Cardboard sleeve	2	Top and Bottom
Cardboard strip	2	Between back of enclosure and inner panel
Plastic bag	1	To protect cover surface and inside gasket
Plastic strap - Black	2	To Squeeze the 2 cardboard sleeve together
Packaging label	1	White label with product number

Qty	Part Number	Rev	Description
1	STK-K-03000	1	5100 ES Accessory Kit
1	5300ESG302408C	0	5300ESG 30" x 24" Cover
1	5300ESG302408B	0	5300ESG 30" x 24" x 8" Body
2	STK-Q-04050-08	0	M6 x 8mm Hexagon Socket Head Machine Screw
Parts List			

This drawing is confidential and must not be reproduced or used without the consent of EXM

Ce dessin est confidentiel et ne doit pas être reproduit ou utilisé sans le consentement de EXM

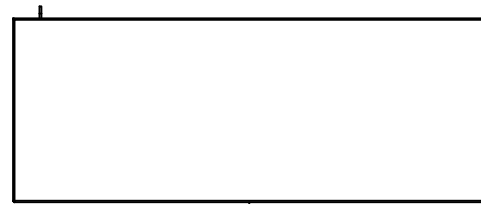

TOP

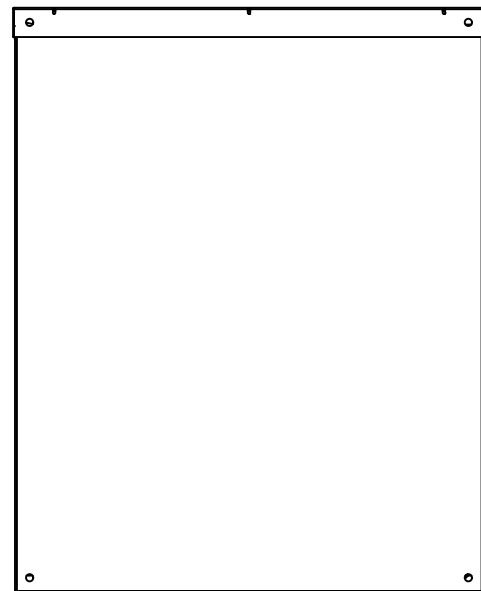

BACK

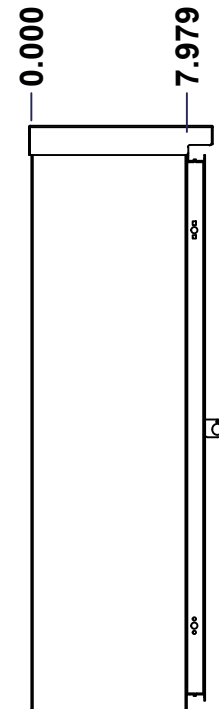

LEFT

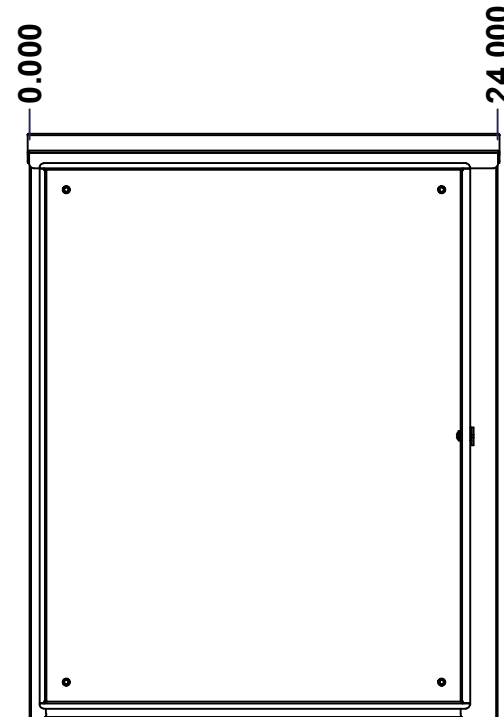

FRONT

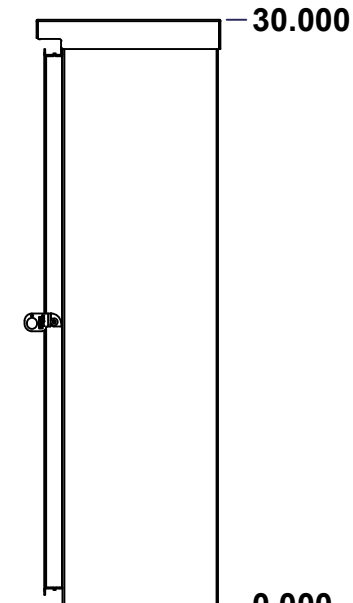

RIGHT

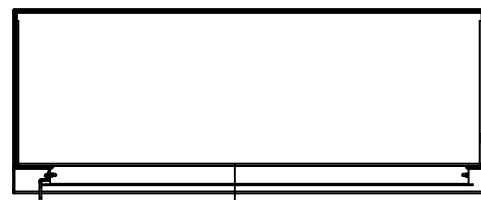

BOTTOM

No.	Revisions	Date	By/Par

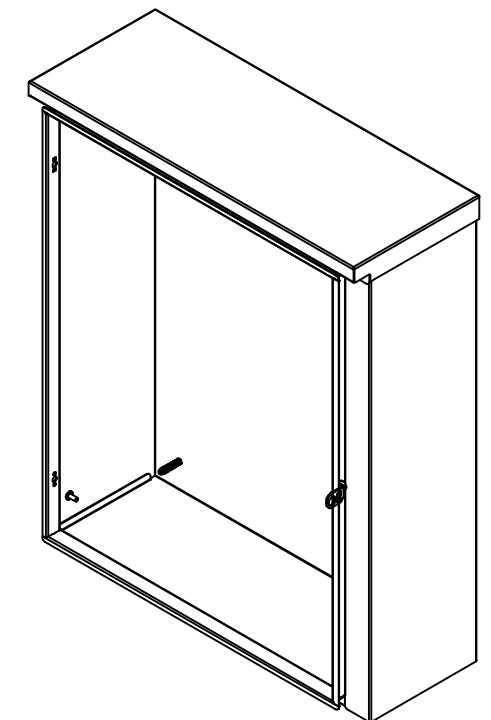

Isometric View



Tél: (450) 979-4373
 Fax: (450) 979-4626
www.exmweb.com

Flatness
Aplatissement

Max 3.0mm

Projection

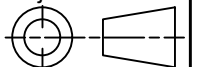

Customer Client	Date
Drawn By Dessiné Par BoxCad: BoxCad	Date 01-Feb-22
Material Matière 16 Ga Galvanized (1.4mm)	
Color Couleur Asa-61 Grey	Finish Fini Smooth
Description 5300ESG 30" x 24" x 8" Body	Detail Rev.
Part Number Numéro Pièce 5300ESG302408B	Rev. 3 0

SEE BILL OF MATERIAL ON LAST PAGE

This drawing is confidential and must not be reproduced or used without the consent of EXM

Ce dessin est confidentiel et ne doit pas être reproduit ou utilisé sans le consentement de EXM

STANDARD FEATURES ARE NOT LISTED IN THIS HOLE TABLE			
HOLE TABLE - RIGHT VIEW (CUSTOM FEATURE ONLY)			
CUT-OUT	XDIM	YDIM	DESCRIPTION
1	8.418	14.500	Padlock 880 PLH

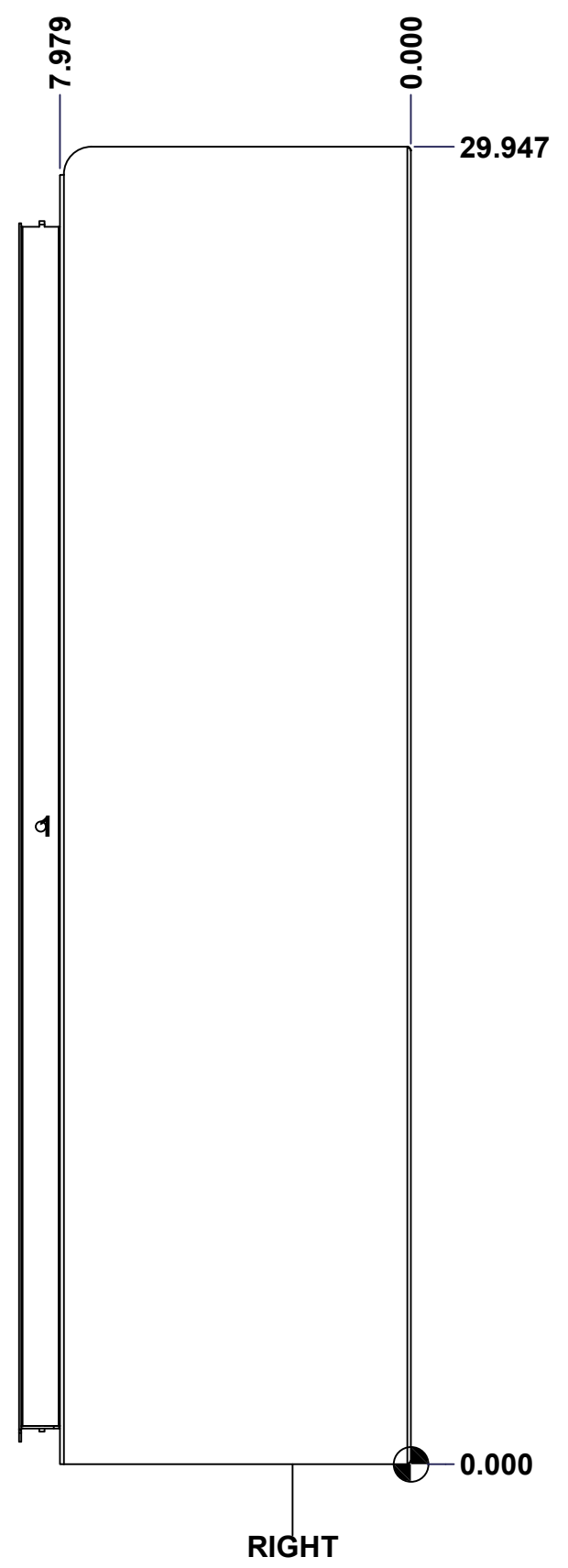

	Description	Status	
	5300ESG 30" x 24" x 8" Body	(NULL)	
	Part Number Numéro Pièce	Rev.	4
	5300ESG302408B	0	10

This drawing is confidential and must not be reproduced or used without the consent of EXM

Ce dessin est confidentiel et ne doit pas être reproduit ou utilisé sans le consentement de EXM

STANDARD FEATURES ARE NOT LISTED IN THIS HOLE TABLE			
HOLE TABLE - LEFT VIEW (CUSTOM FEATURE ONLY)			
CUT-OUT	XDIM	YDIM	DESCRIPTION
1	6.500	2.000	GND STUD M6 x 16mm (Inside)

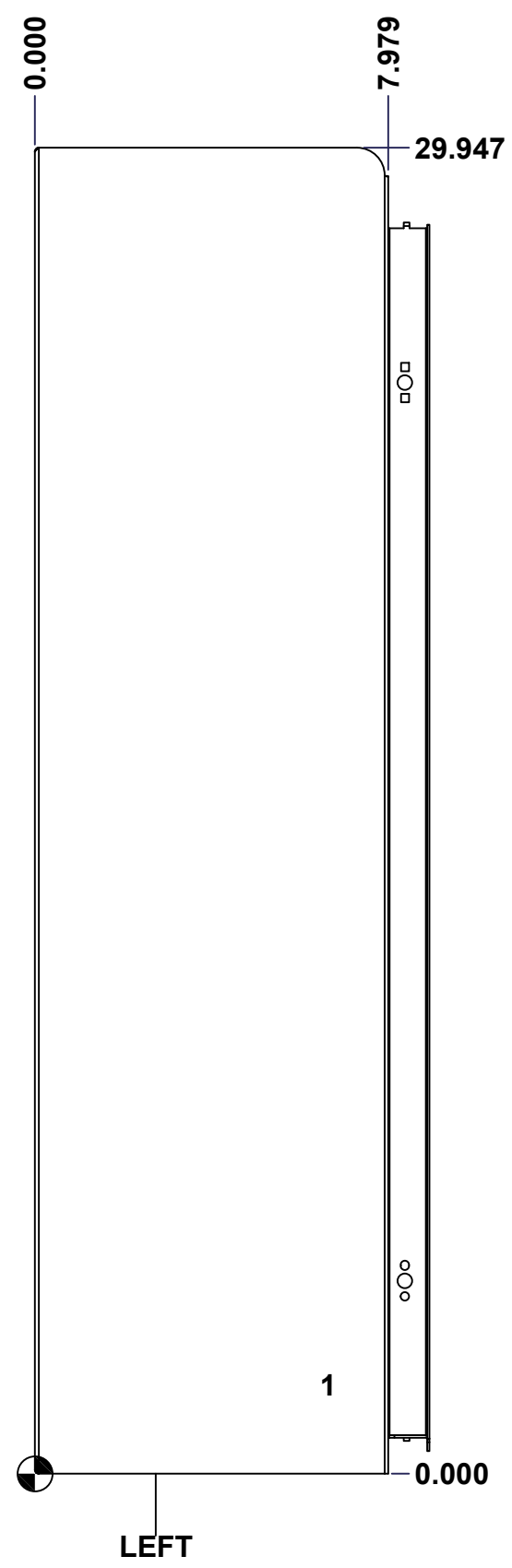

	Description	Status	
	5300ESG 30" x 24" x 8" Body	(NULL)	
	Part Number Numéro Pièce	Rev.	5
	5300ESG302408B	0	10

This drawing is confidential and must not be reproduced or used without the consent of EXM

Ce dessin est confidentiel et ne doit pas être reproduit ou utilisé sans le consentement de EXM

STANDARD FEATURES ARE NOT LISTED IN THIS HOLE TABLE

HOLE TABLE - BACK VIEW (CUSTOM FEATURE ONLY)

CUT-OUT	XDIM	YDIM	DESCRIPTION
1	3.000	3.000	IP STUD M8 x 35mm (Inside)
2	3.000	27.000	IP STUD M8 x 35mm (Inside)
3	21.000	27.000	IP STUD M8 x 35mm (Inside)
4	21.000	3.000	IP STUD M8 x 35mm (Inside)

5	23.250	0.750	RND Ø0.390
6	23.250	29.250	RND Ø0.390
7	0.750	29.250	RND Ø0.390
8	0.750	0.750	RND Ø0.390

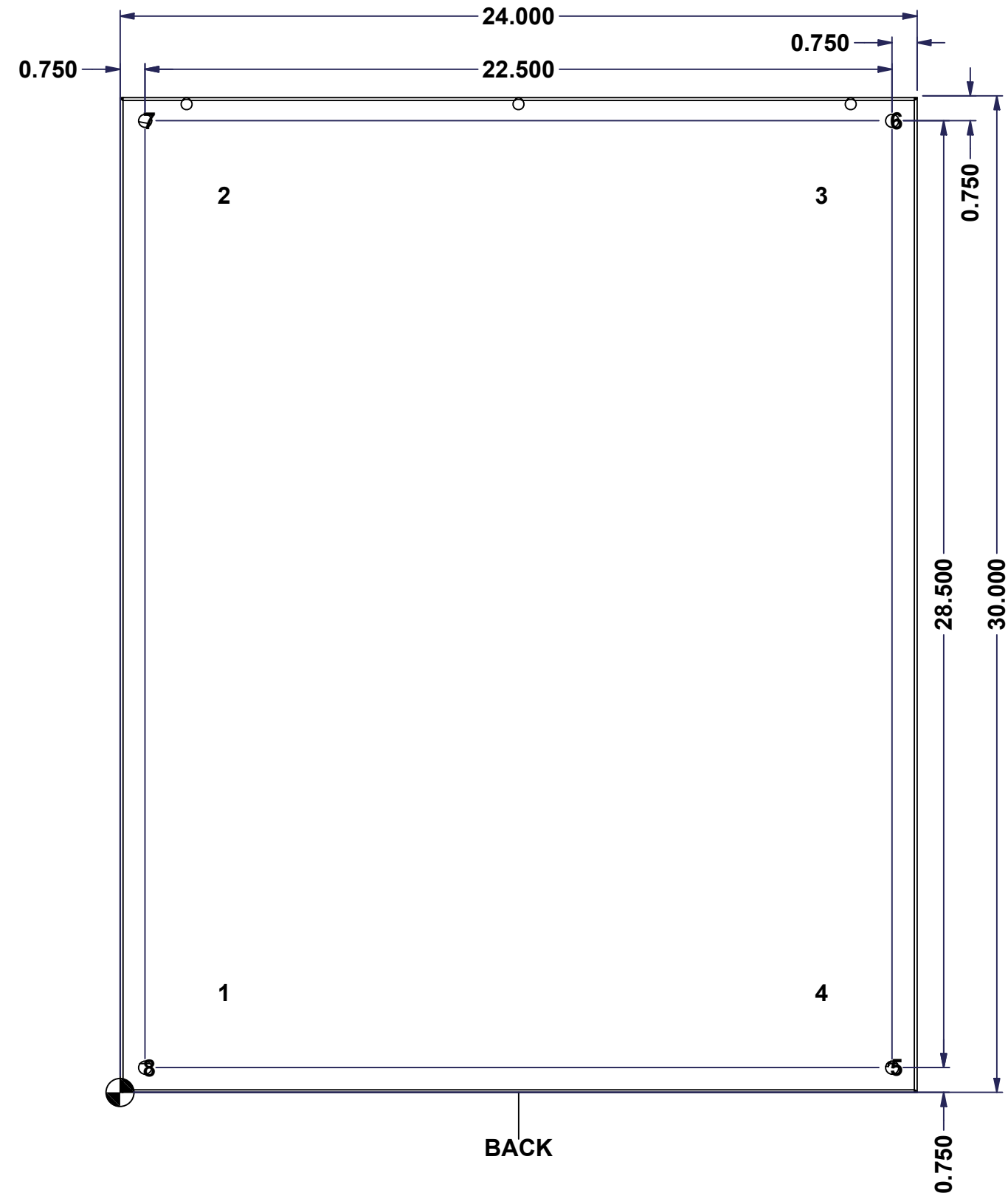

BACK

	Description	Status
	5300ESG 30" x 24" x 8" Body	(NULL)
	Part Number Numéro Pièce	Rev.
	5300ESG302408B	0 / 6
		10

This drawing is confidential and must not be reproduced or used without the consent of EXM

Ce dessin est confidentiel et ne doit pas être reproduit ou utilisé sans le consentement de EXM

No.	Revisions	Date	By/Par

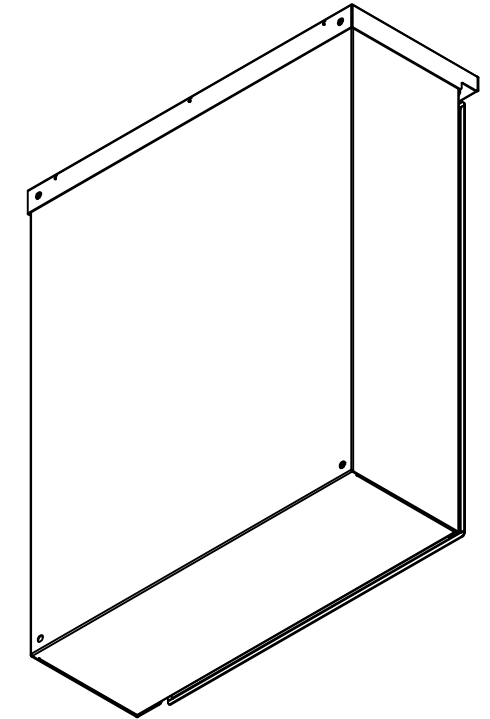

Isometric View



Tél: (450) 979-4373
 Fax: (450) 979-4626
www.exmweb.com

Flatness
Aplatissement
Max 3.0mm
Projection

Customer Client	Date
Drawn By / Dessiné Par: BoxCad: BoxCad	Date: 01-Feb-22
Material / Matière: 16 Ga Galvanized (1.4mm)	

Color / Couleur: Asa-61 Grey	Finish / Fini: Smooth
------------------------------	-----------------------

Description: 5300ESG 30" x 24" x 8" Body	Detail Rev.
--	-------------

Part Number / Numéro Pièce: 5300ESG302408B	Rev. 0	7 / 10
---	--------	--------

Qty	Part Number	Rev	Description
1	STK-Q-16080	0	Ground Stud M6 x 16mm Steel
1	STK-K-91208	0	5300 ESG Padlock Kit
1	STK-P-02400S	0	Powder Paint (Asa-61 Grey / Smooth)
4	STK-Q-16005	1	Stud M8 x 35 (No Paint Cap Required)
1	5300ESG302408T-P	0	5300ESG 30" x 24" x 8" Top Part
1	5300ESG302408B-P	0	5300ESG 30" x 24" x 8" Body Part
Parts List			

This drawing is confidential and must not be reproduced or used without the consent of EXM

Ce dessin est confidentiel et ne doit pas être reproduit ou utilisé sans le consentement de EXM

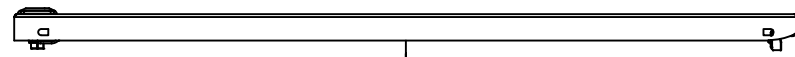

TOP

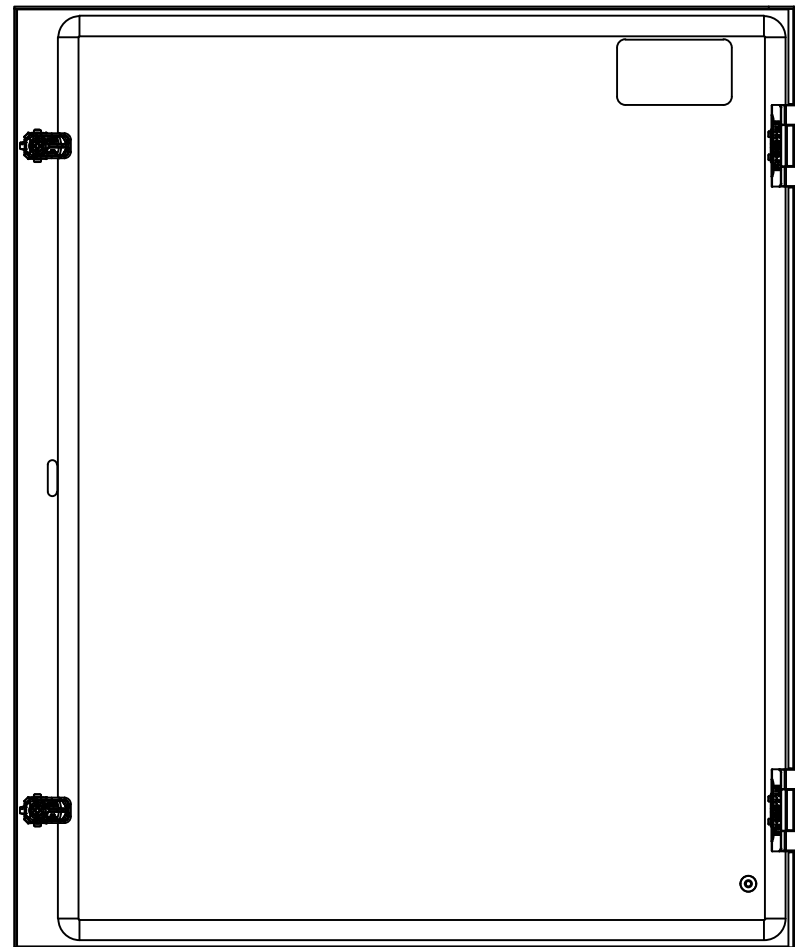

BACK

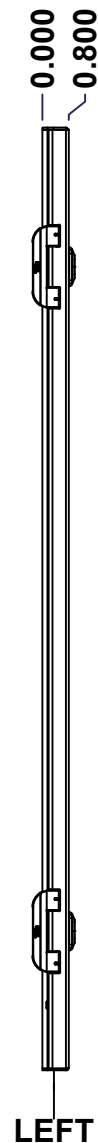

LEFT

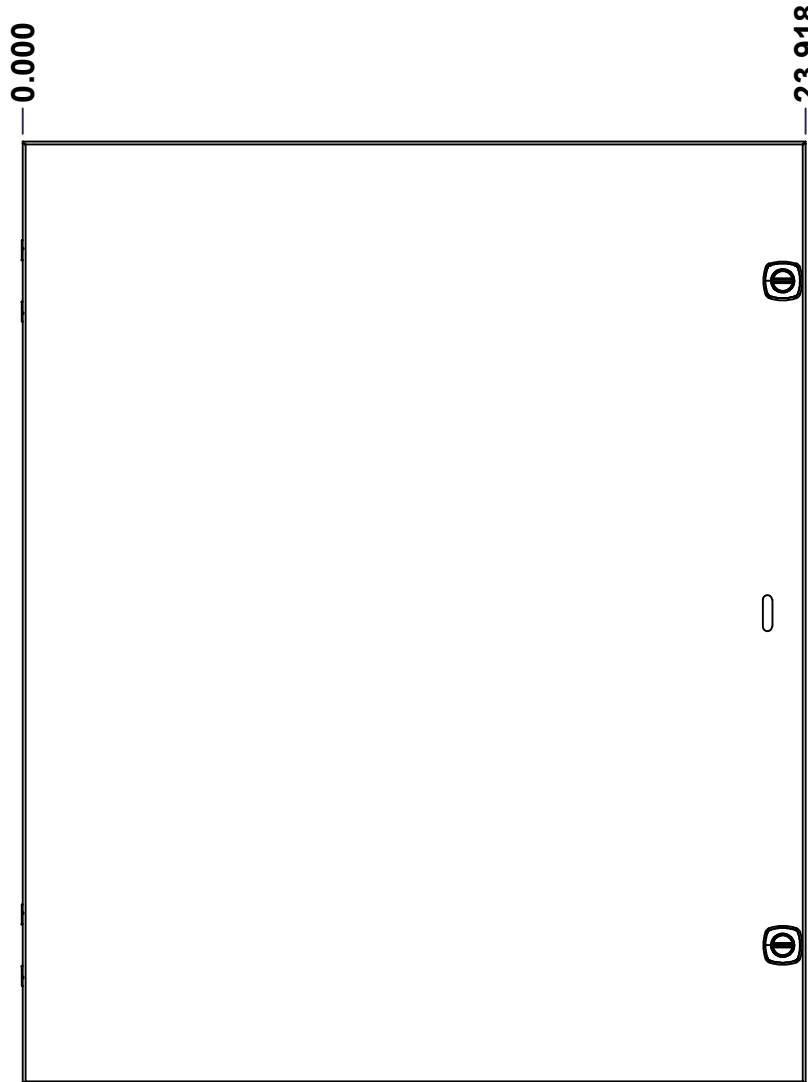

FRONT

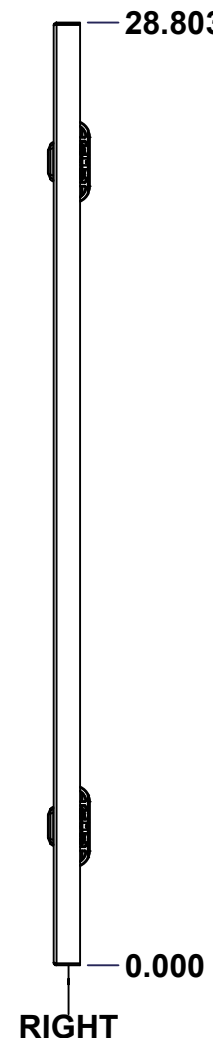

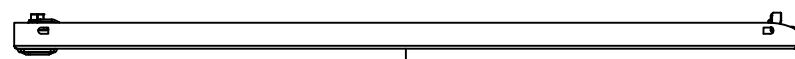

RIGHT

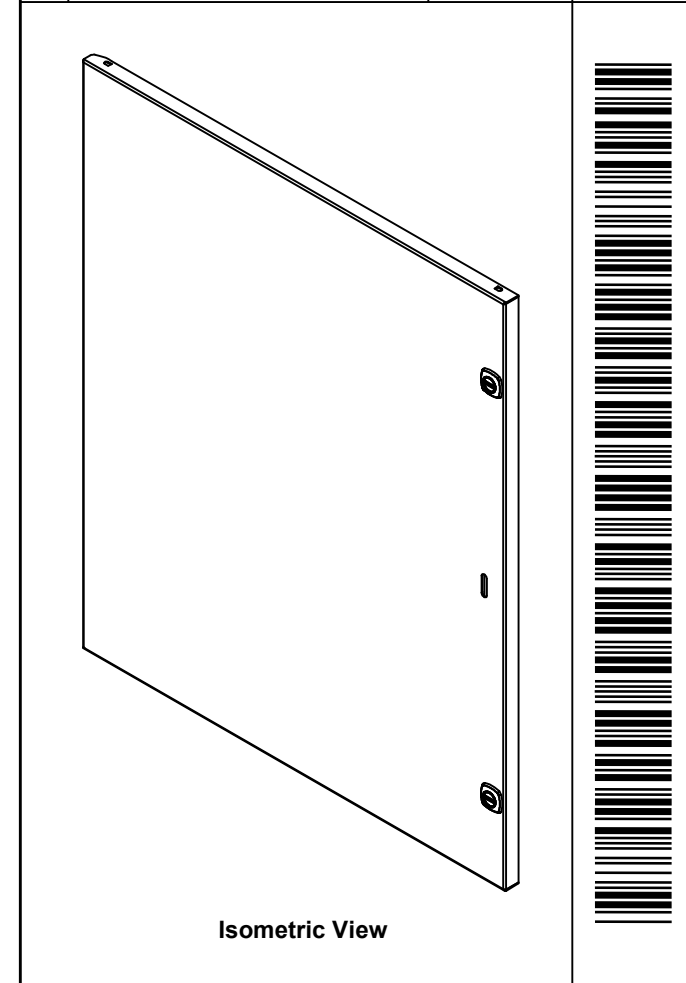

BOTTOM

No.	Revisions	Date	By/Par



 Tél: (450) 979-4373 Fax: (450) 979-4626 www.exmweb.com		Flatness Aplatissement	
		Max 3.0mm	
Customer Client		Date	
Drawn By Dessiné Par BoxCad: BoxCad		Date 01-Feb-22	
Material Matière 16 Ga Galvanized (1.4mm)			
Color Couleur Asa-61 Grey		Finish Fini Smooth	
Description 5300ESG 30" x 24" Cover			Detail Rev.
Part Number Numéro Pièce 5300ESG302408C		Rev. 0	8 / 10

SEE BILL OF MATERIAL ON LAST PAGE

This drawing is confidential and must not be reproduced or used without the consent of EXM

Ce dessin est confidentiel et ne doit pas être reproduit ou utilisé sans le consentement de EXM

STANDARD FEATURES ARE NOT LISTED IN THIS HOLE TABLE			
HOLE TABLE - FRONT VIEW (CUSTOM FEATURE ONLY)			
CUT-OUT	XDIM	YDIM	DESCRIPTION
1	22.755	14.401	Padlock 880 PLH
2	3.750	26.803	LABEL_EXM (Inside)
3	1.486	2.000	GND STUD M6 x 16mm (Inside)
4	23.218	24.553	880 SCQ4CH-SL
5	23.218	4.250	880 SCQ4CH-SL

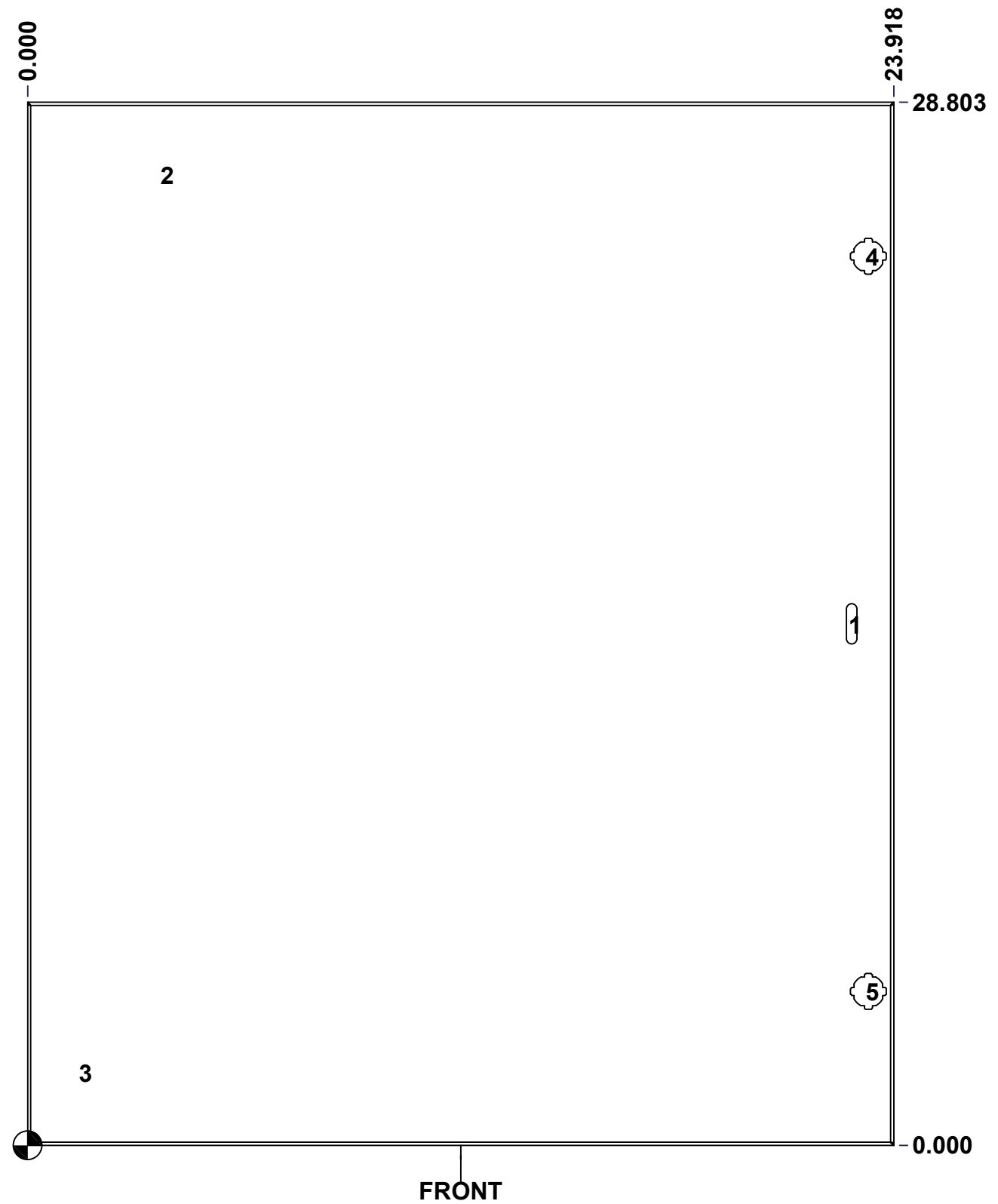

FRONT

	Description	Status
	5300ESG 30" x 24" Cover	(NULL)
	Part Number Numéro Pièce	Rev.
	5300ESG302408C	0 / 9
		10

This drawing is confidential and must not be reproduced or used without the consent of EXM

Ce dessin est confidentiel et ne doit pas être reproduit ou utilisé sans le consentement de EXM

No.	Revisions	Date	By/Par

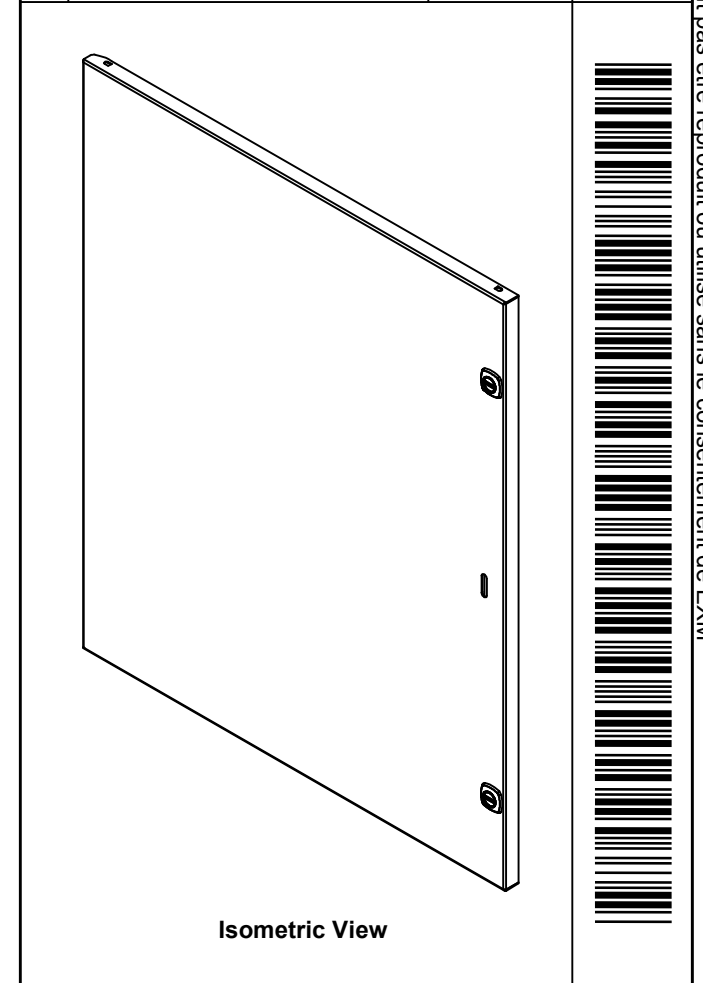

 Tél: (450) 979-4373
 Fax: (450) 979-4626
www.exmweb.com

Flatness
 Aplatissement
 Max 3.0mm
Projection

Customer Client	Date
Drawn By / Dessiné Par: BoxCad: BoxCad	Date: 01-Feb-22
Material / Matière: 16 Ga Galvanized (1.4mm)	

Color / Couleur: Asa-61 Grey	Finish / Fini: Smooth
Description: 5300ESG 30" x 24" Cover	
Detail Rev.	

Part Number / Numéro Pièce: 5300ESG302408C	Rev. 0	10
		10

QTY	Part Number	Rev	Description
1	STK-Q-16080	0	Ground Stud M6 x 16mm Steel
1	STK-S-00100	0	3.5" x 2" Silver Milar Flexcon Sticker
1	STK-P-02400S	0	Powder Paint (Asa-61 Grey / Smooth)
1	5300ESG302408G	0	5300ESG 30" x 24" Cover Gasket Part
1	5300ESG302408C-P	0	5300ESG 30" x 24" Cover Part
2	880 SCQ4CH-SL	0	5412 CH 1/4 Turn Lock
2	STK-K-09800	10	5412 ES Hinge with 2 Captive Hinge Pins
Parts List			