

This drawing is confidential and must not be reproduced or used without the consent of EXM

Ce dessin est confidentiel et ne doit pas être reproduit ou utilisé sans le consentement de EXM

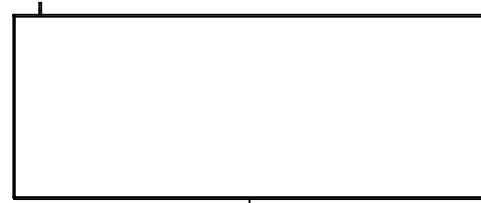

TOP

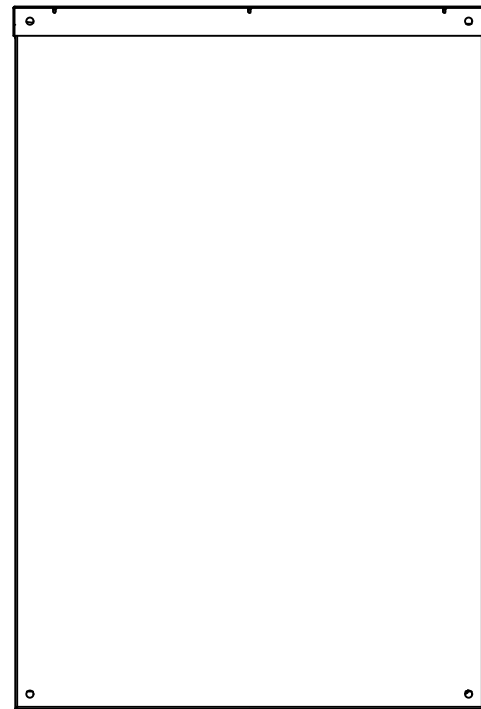

BACK



BOTTOM

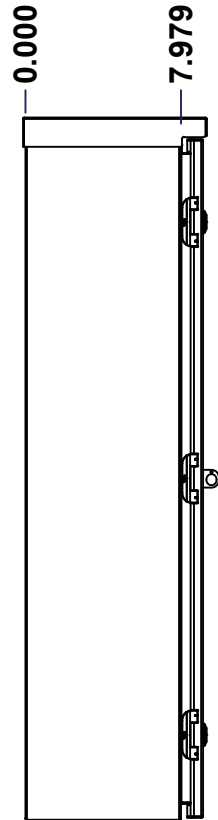

LEFT

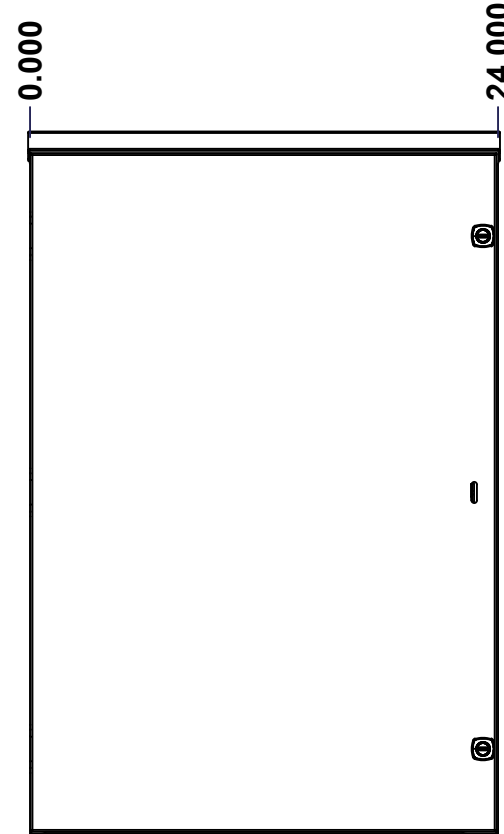

FRONT

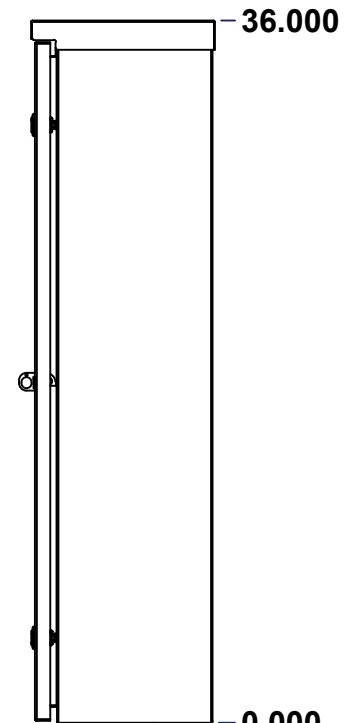

RIGHT

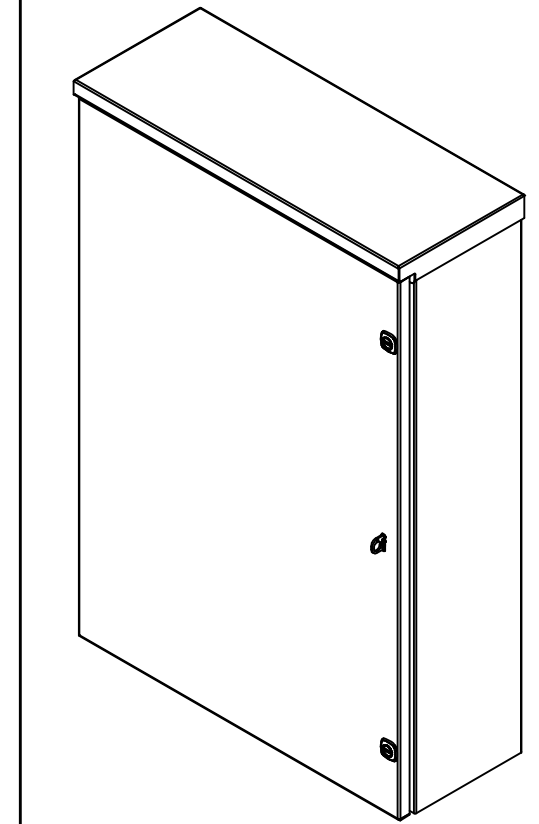

Isometric View

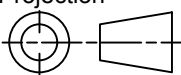

No.	Revisions	Date	By/Par

 Tél: (450) 979-4373 Fax: (450) 979-4626 www.exmweb.com		Flatness Aplatissement Max 3.0mm Projection 
Customer Client	Date	
Drawn By Dessiné Par	BoxCad: BoxCad	Date 04-Jan-22
Material Matière	16 Ga Galvanized (1.4mm)	
Color Couleur	Asa-61 Grey	Finish Fini Smooth
Description	Detail Rev.	
5300ESG 36" x 24" x 8" Assembly		
Part Number Numéro Pièce	Rev.	1
5300ESG362408	0	10

SEE BILL OF MATERIAL ON LAST PAGE

This drawing is confidential and must not be reproduced or used without the consent of EXM

Ce dessin est confidentiel et ne doit pas être reproduit ou utilisé sans le consentement de EXM

NOTE	
ITEM	DESCRIPTION
1	NEMA 3/3R Enclosure
2	C/W Standard ground studs on box and cover
3	W/O Standard door stiffener
4	W/O Inner panel
5	C/W Standard inner panel mounting studs
6	C/W Padlock sold separately (Kit)

No.	Revisions	Date	By/Par

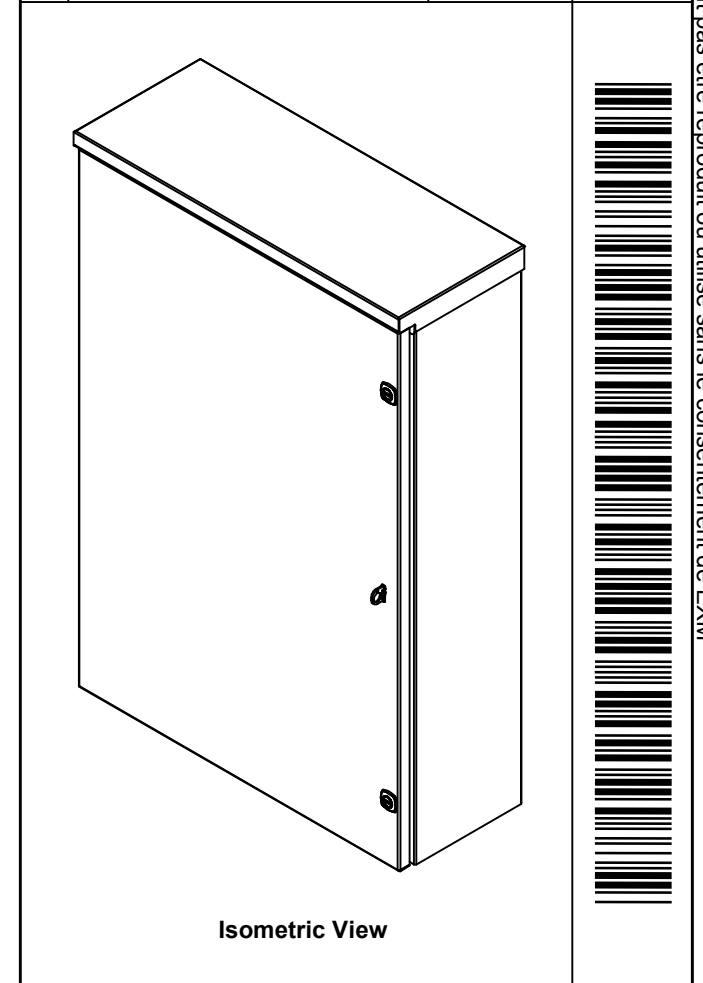

Tél: (450) 979-4373
Fax: (450) 979-4626
www.exmweb.com

Flatness
Aplatissement
Max 3.0mm

Projection

Customer Client	Date
Drawn By / Dessiné Par: BoxCad: BoxCad	Date: 04-Jan-22
Material / Matière: 16 Ga Galvanized (1.4mm)	
Color / Couleur: Asa-61 Grey	Finish / Fini: Smooth

Description: 5300ESG 36" x 24" x 8" Assembly		Detail Rev.	
Part Number / Numéro Pièce: 5300ESG362408		Rev.:	2
		0	10

PACKING		
ITEM	QTY	DESCRIPTION
Cardboard sleeve	2	Top and Bottom
Cardboard strip	2	Between back of enclosure and inner panel
Plastic bag	1	To protect cover surface and inside gasket
Plastic strap - Black	2	To Squeeze the 2 cardboard sleeve together
Packaging label	1	White label with product number

Qty	Part Number	Rev	Description
1	STK-K-03000	1	5100 ES Accessory Kit
1	5300ESG362408C	0	5300ESG 36" x 24" Cover
1	5300ESG362408B	0	5300ESG 36" x 24" x 8" Body
3	STK-Q-04050-08	0	M6 x 8mm Hexagon Socket Head Machine Screw
Parts List			

This drawing is confidential and must not be reproduced or used without the consent of EXM

Ce dessin est confidentiel et ne doit pas être reproduit ou utilisé sans le consentement de EXM

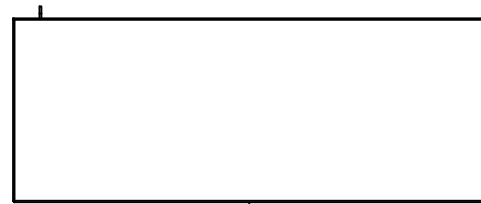

TOP

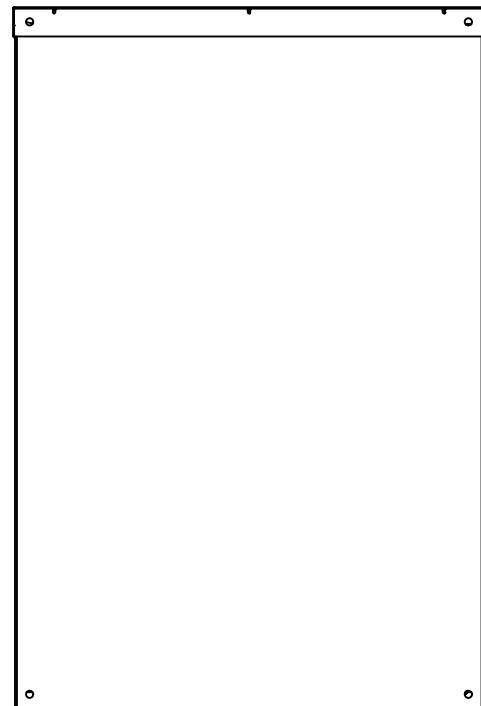

BACK

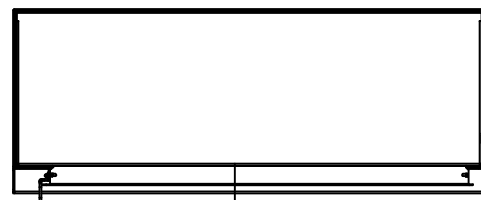

BOTTOM

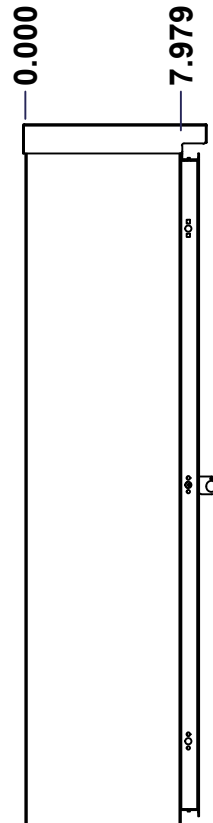

LEFT

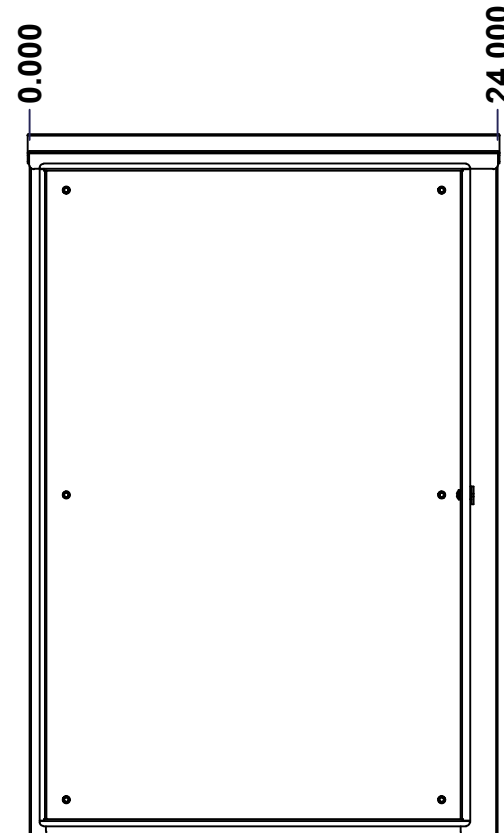

FRONT

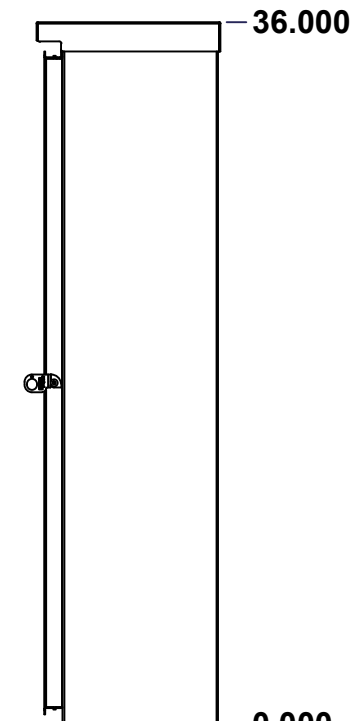

RIGHT

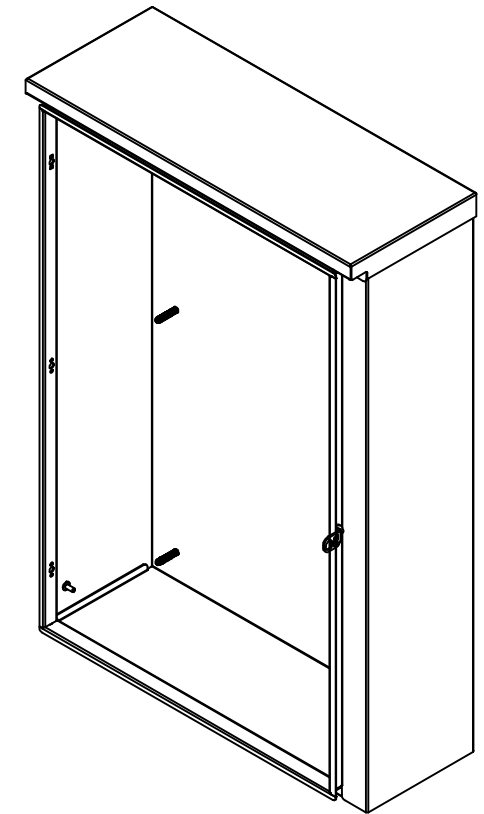

Isometric View

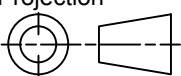

No.	Revisions	Date	By/Par

 Tél: (450) 979-4373 Fax: (450) 979-4626 www.exmweb.com		Flatness Aplatissement Max 3.0mm Projection 
Customer Client	Date	
Drawn By Dessiné Par	BoxCad: BoxCad	Date 04-Jan-22
Material Matière	16 Ga Galvanized (1.4mm)	
Color Couleur	Asa-61 Grey	Finish Fini Smooth
Description	Detail Rev.	
5300ESG 36" x 24" x 8" Body		
Part Number Numéro Pièce	Rev. 0	3 / 10

SEE BILL OF MATERIAL ON LAST PAGE

5300ESG362408B

This drawing is confidential and must not be reproduced or used without the consent of EXM

Ce dessin est confidentiel et ne doit pas être reproduit ou utilisé sans le consentement de EXM

STANDARD FEATURES ARE NOT LISTED IN THIS HOLE TABLE			
HOLE TABLE - RIGHT VIEW (CUSTOM FEATURE ONLY)			
CUT-OUT	XDIM	YDIM	DESCRIPTION
1	8.418	17.500	Padlock 880 PLH

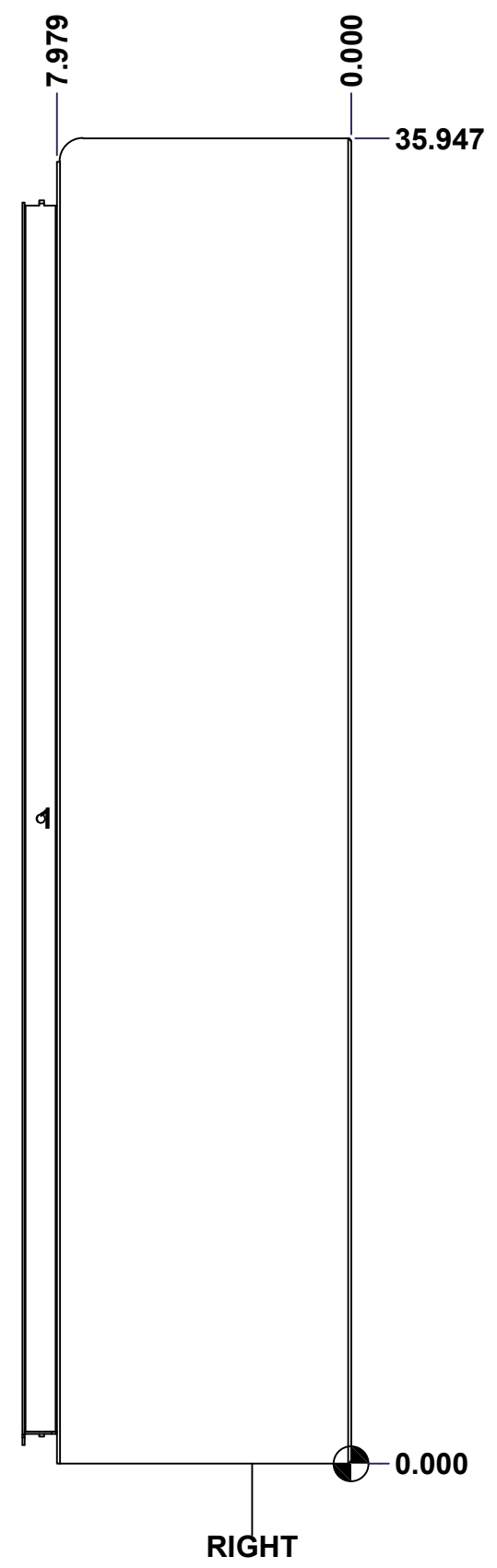

	Description	Status
	5300ESG 36" x 24" x 8" Body	(NULL)
Part Number Numéro Pièce 5300ESG362408B	Rev.	4
	0	10

This drawing is confidential and must not be reproduced or used without the consent of EXM

Ce dessin est confidentiel et ne doit pas être reproduit ou utilisé sans le consentement de EXM

STANDARD FEATURES ARE NOT LISTED IN THIS HOLE TABLE			
HOLE TABLE - LEFT VIEW (CUSTOM FEATURE ONLY)			
CUT-OUT	XDIM	YDIM	DESCRIPTION
1	6.500	2.000	GND STUD M6 x 16mm (Inside)

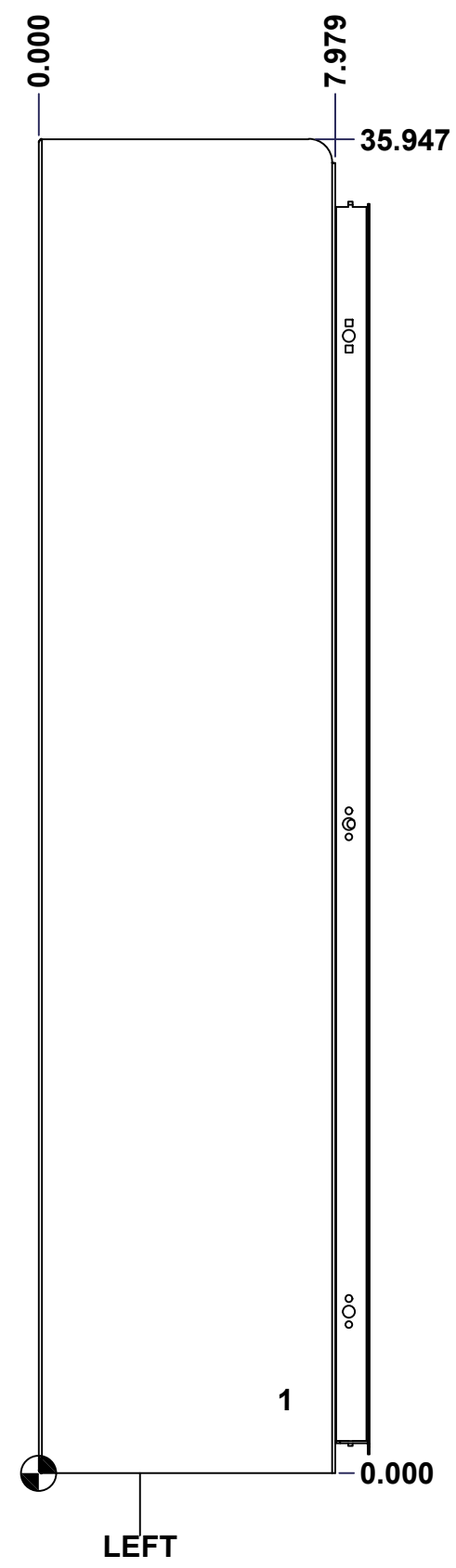

	Description	Status	
	5300ESG 36" x 24" x 8" Body	(NULL)	
Part Number Numéro Pièce 5300ESG362408B	Rev.	5	10
	0		

This drawing is confidential and must not be reproduced or used without the consent of EXM

Ce dessin est confidentiel et ne doit pas être reproduit ou utilisé sans le consentement de EXM

STANDARD FEATURES ARE NOT LISTED IN THIS HOLE TABLE

HOLE TABLE - BACK VIEW (CUSTOM FEATURE ONLY)

CUT-OUT	XDIM	YDIM	DESCRIPTION
1	3.000	3.000	IP STUD M8 x 35mm (Inside)
2	3.000	33.000	IP STUD M8 x 35mm (Inside)
3	21.000	33.000	IP STUD M8 x 35mm (Inside)
4	21.000	3.000	IP STUD M8 x 35mm (Inside)
5	3.000	18.000	IP STUD M8 x 35mm (Inside)
6	21.000	18.000	IP STUD M8 x 35mm (Inside)

7	23.250	0.750	RND Ø0.390
8	23.250	35.250	RND Ø0.390
9	0.750	35.250	RND Ø0.390
10	0.750	0.750	RND Ø0.390

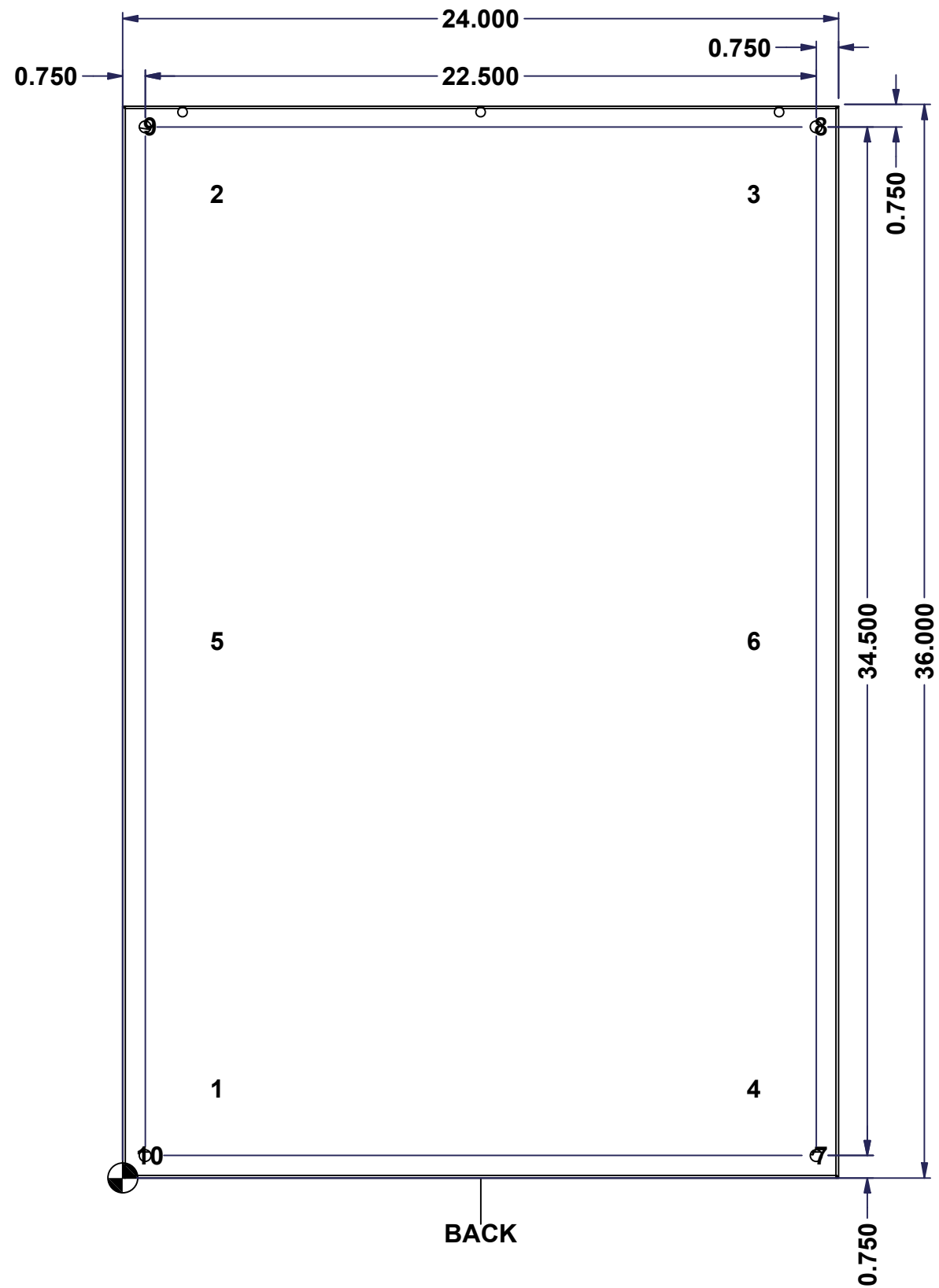

	Description	Status	
	5300ESG 36" x 24" x 8" Body	(NULL)	
	Part Number	Rev.	6
	Numéro Pièce	0	10
	5300ESG362408B		

This drawing is confidential and must not be reproduced or used without the consent of EXM

Ce dessin est confidentiel et ne doit pas être reproduit ou utilisé sans le consentement de EXM

No.	Revisions	Date	By/Par

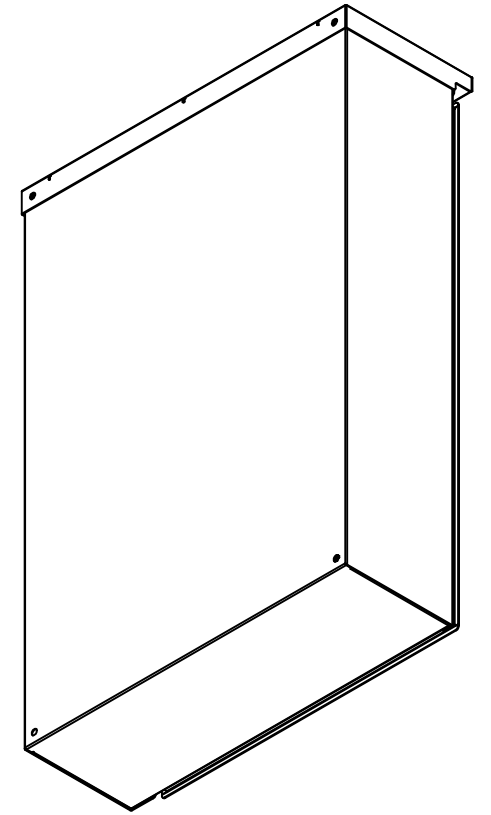

Isometric View



Tél: (450) 979-4373
 Fax: (450) 979-4626
www.exmweb.com

Flatness
Aplatissement
Max 3.0mm
Projection

Customer Client	Date
Drawn By / Dessiné Par: BoxCad: BoxCad	Date: 04-Jan-22
Material / Matière: 16 Ga Galvanized (1.4mm)	

Color / Couleur: Asa-61 Grey	Finish / Fini: Smooth
------------------------------	-----------------------

Description: 5300ESG 36" x 24" x 8" Body	Detail Rev.
--	-------------

Part Number / Numéro Pièce: 5300ESG362408B	Rev. 0	7 / 10
---	--------	--------

Qty	Part Number	Rev	Description
1	STK-Q-16080	0	Ground Stud M6 x 16mm Steel
1	STK-K-91208	0	5300 ESG Padlock Kit
1	STK-P-02400S	0	Powder Paint (Asa-61 Grey / Smooth)
6	STK-Q-16005	1	Stud M8 x 35 (No Paint Cap Required)
1	5300ESG362408T-P	0	5300ESG 36" x 24" x 8" Top Part
1	5300ESG362408B-P	0	5300ESG 36" x 24" x 8" Body Part
Parts List			

This drawing is confidential and must not be reproduced or used without the consent of EXM

Ce dessin est confidentiel et ne doit pas être reproduit ou utilisé sans le consentement de EXM

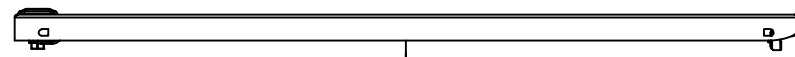

TOP

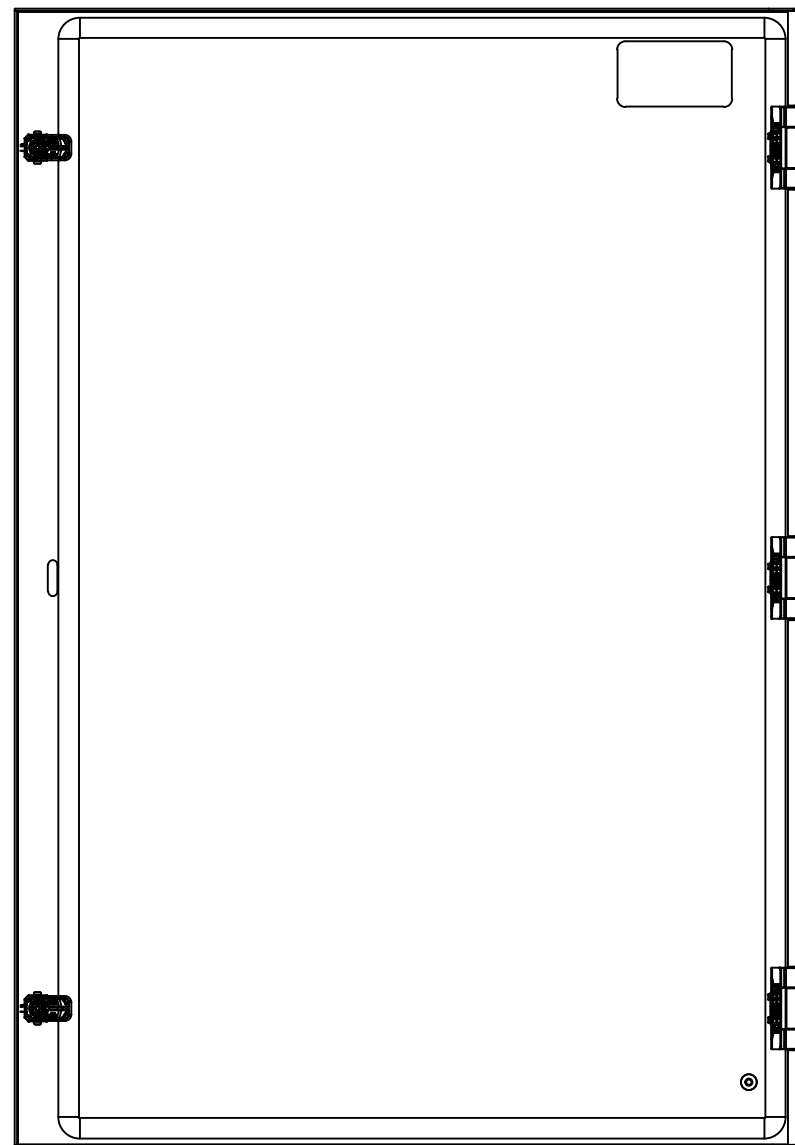

BACK

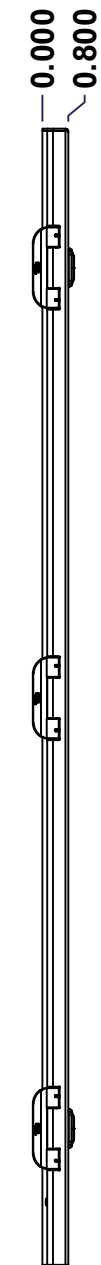

LEFT

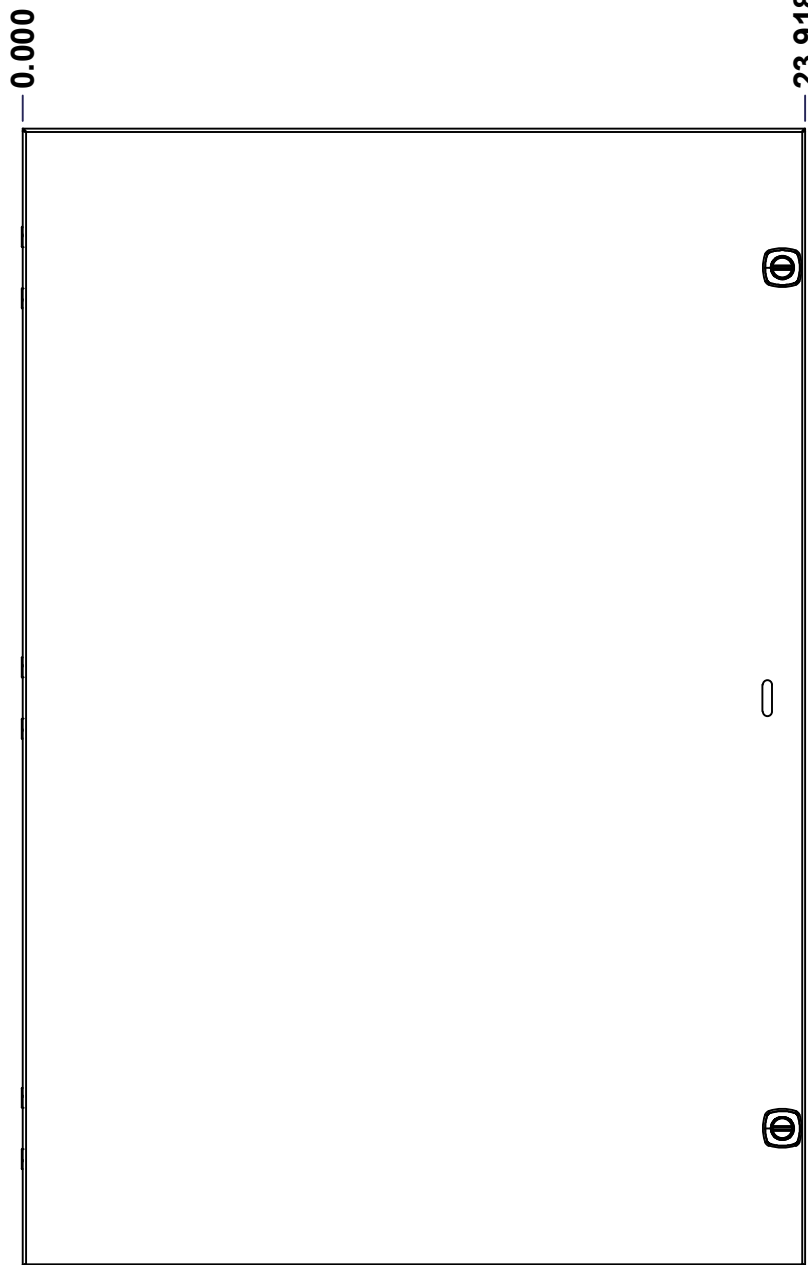

FRONT

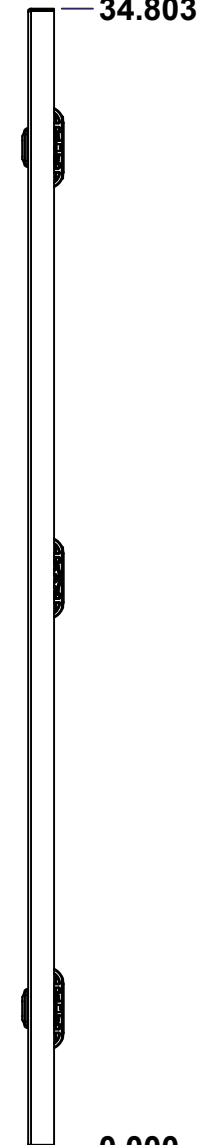

RIGHT

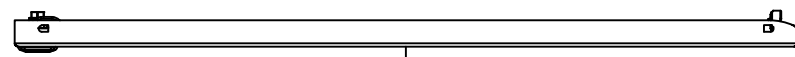

BOTTOM

No.	Revisions	Date	By/Par

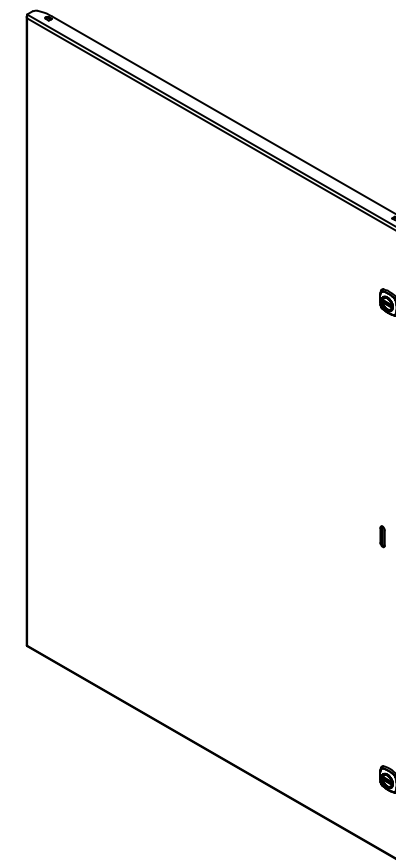

Isometric View



Tél: (450) 979-4373
 Fax: (450) 979-4626
www.exmweb.com

Flatness
Aplatissement

Max 3.0mm

Projection



Customer Client	Date
Drawn By Dessiné Par BoxCad: BoxCad	Date 04-Jan-22
Material Matière 14 Ga Galvanized (1.7mm)	

Color Couleur Asa-61 Grey	Finish Fini Smooth
------------------------------	-----------------------

Description 5300ESG 36" x 24" Cover	Detail Rev.
--	-------------

Part Number Numéro Pièce 5300ESG362408C	Rev. 0	8 10
--	------------------	---------

SEE BILL OF MATERIAL ON LAST PAGE

This drawing is confidential and must not be reproduced or used without the consent of EXM

Ce dessin est confidentiel et ne doit pas être reproduit ou utilisé sans le consentement de EXM

STANDARD FEATURES ARE NOT LISTED IN THIS HOLE TABLE

HOLE TABLE - FRONT VIEW (CUSTOM FEATURE ONLY)

CUT-OUT	XDIM	YDIM	DESCRIPTION
1	22.755	17.401	Padlock 880 PLH
2	23.218	30.553	880 SCQ4CH-SL
3	23.218	4.250	880 SCQ4CH-SL
4	1.486	2.000	GND STUD M6 x 16mm (Inside)
5	3.750	32.803	LABEL_EXM (Inside)

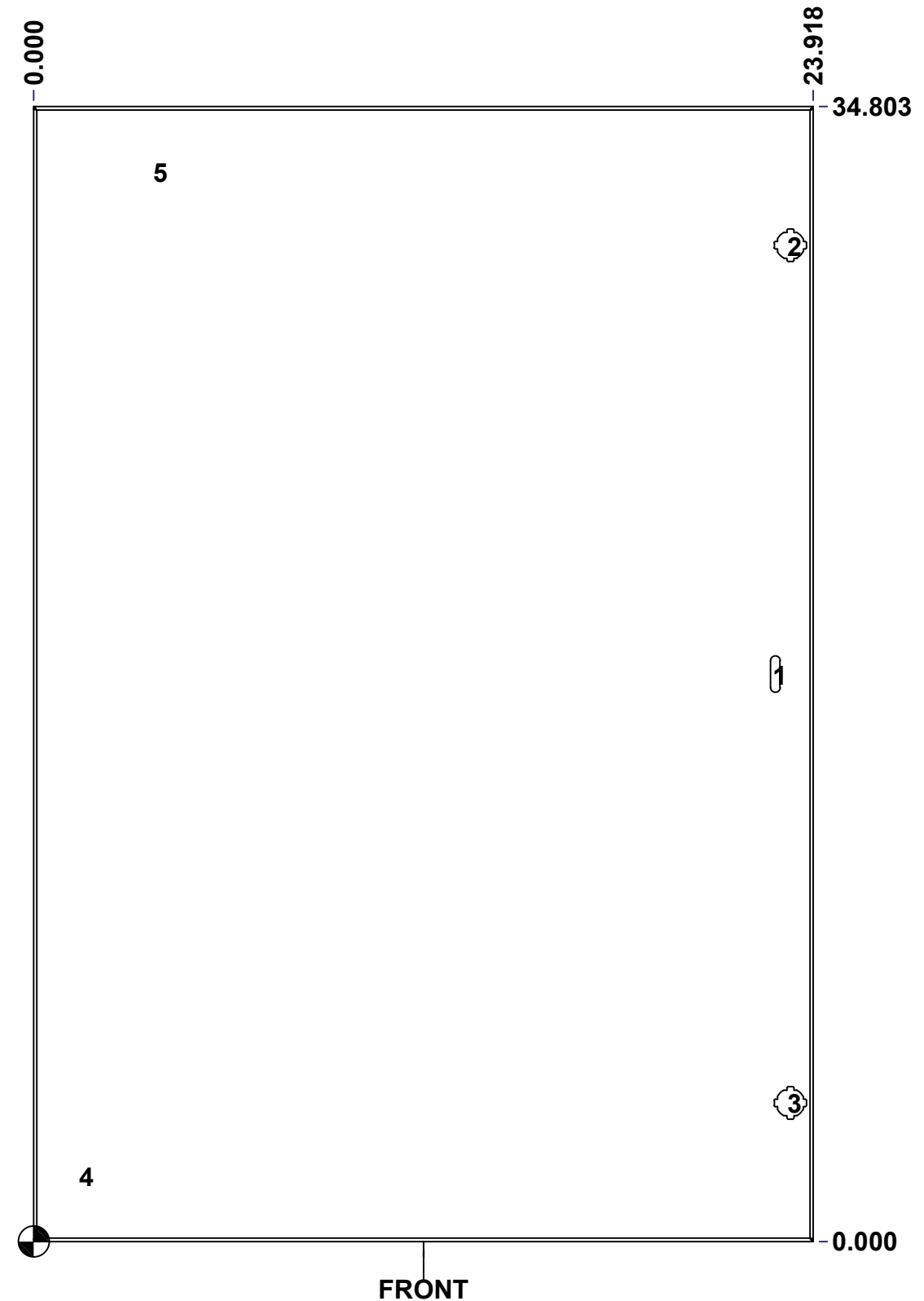

	Description	Status
	5300ESG 36" x 24" Cover	(NULL)
Part Number Numéro Pièce 5300ESG362408C	Rev.	9
	0	10

This drawing is confidential and must not be reproduced or used without the consent of EXM

Ce dessin est confidentiel et ne doit pas être reproduit ou utilisé sans le consentement de EXM

No.	Revisions	Date	By/Par

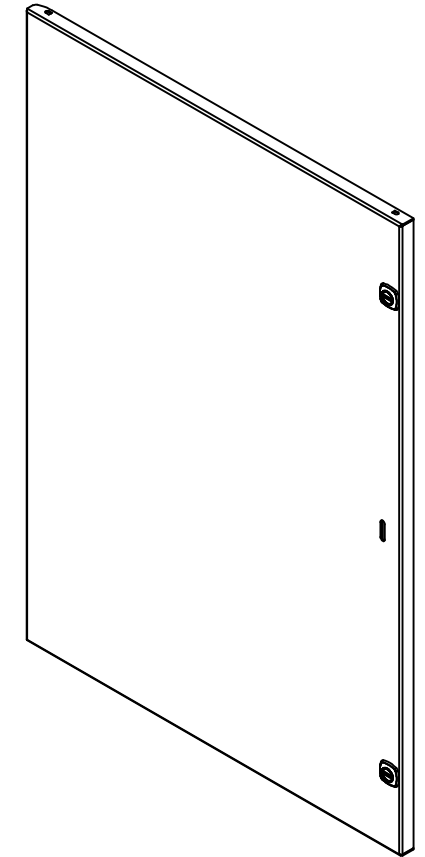

Isometric View

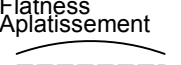

 Tél: (450) 979-4373 Fax: (450) 979-4626 www.exmweb.com		Flatness Aplatissement  Max 3.0mm
Customer Client		Date
Drawn By / Dessiné Par: BoxCad: BoxCad		Date: 04-Jan-22
Material / Matière: 14 Ga Galvanized (1.7mm)		
Color / Couleur: Asa-61 Grey	Finish / Fini: Smooth	
Description: 5300ESG 36" x 24" Cover		Detail Rev.
Part Number / Numéro Pièce: 5300ESG362408C		Rev. 10 0

QTY	Part Number	Rev	Description
1	STK-S-00100	0	3.5" x 2" Silver Milar Flexcon Sticker
1	STK-Q-16080	0	Ground Stud M6 x 16mm Steel
1	STK-P-02400S	0	Powder Paint (Asa-61 Grey / Smooth)
1	5300ESG362408G	0	5300ESG 36" x 24" Cover Gasket Part
1	5300ESG362408C-P	0	5300ESG 36" x 24" Cover Part
2	880 SCQ4CH-SL	0	5412 CH 1/4 Turn Lock
3	STK-K-09800	10	5412 ES Hinge with 2 Captive Hinge Pins
Parts List			