

This drawing is confidential and must not be reproduced or used without the consent of EXM

Ce dessin est confidentiel et ne doit pas être reproduit ou utilisé sans le consentement de EXM

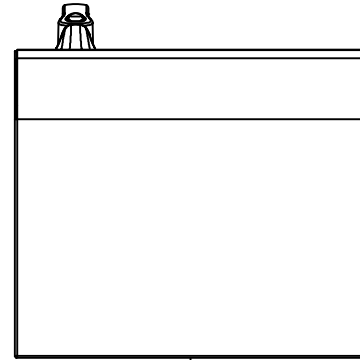

TOP

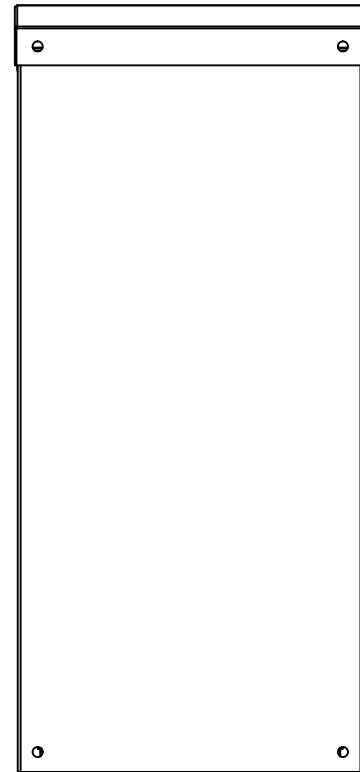

BACK

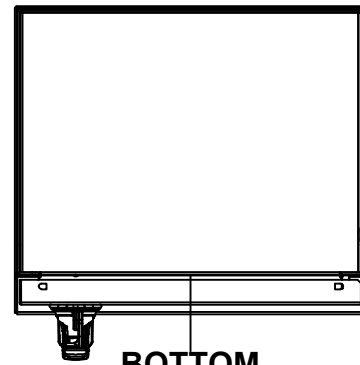

BOTTOM

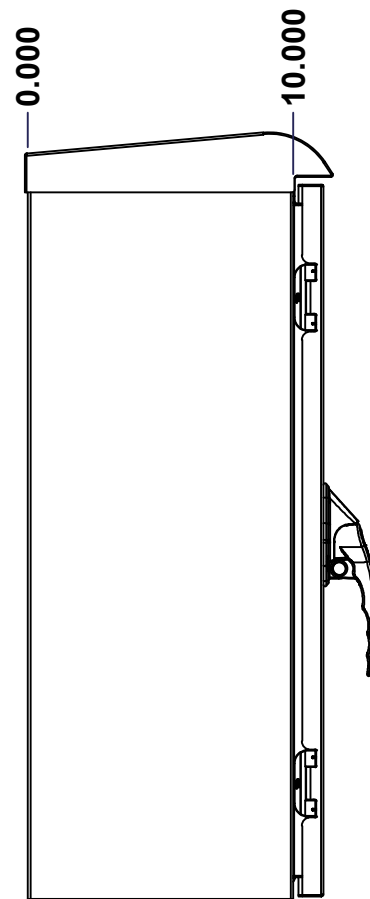

LEFT

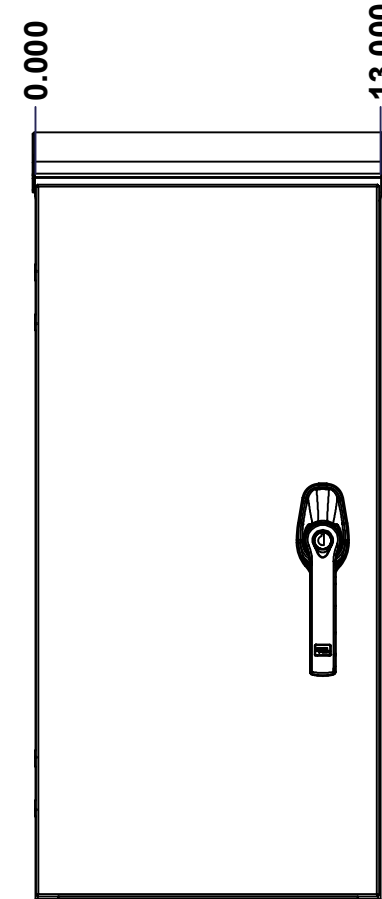

FRONT

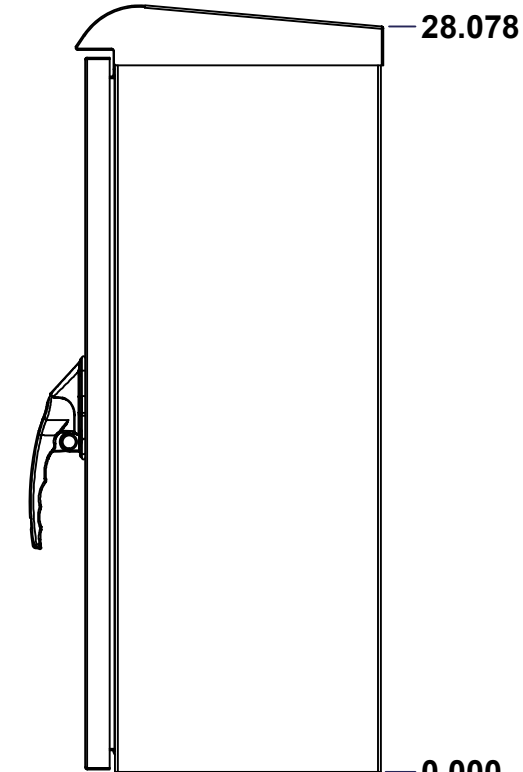

RIGHT

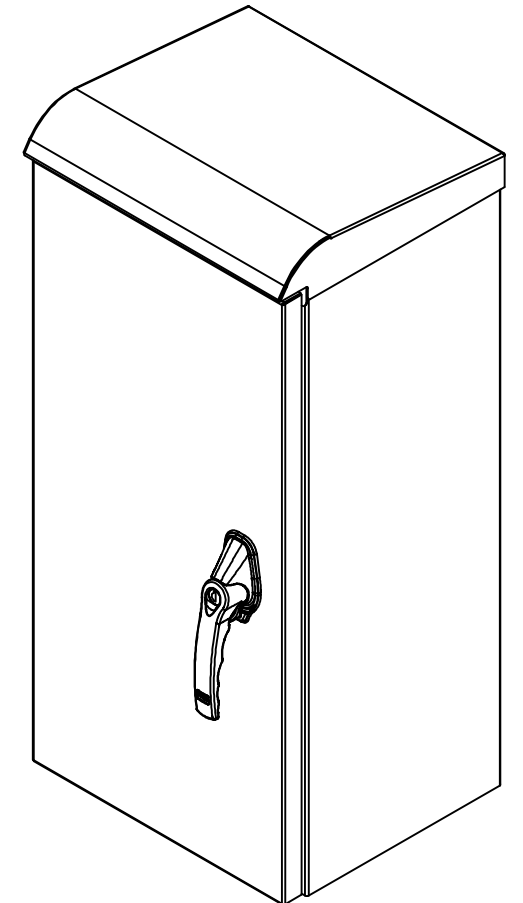

Isometric View

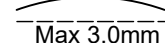
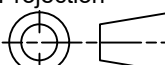

No.	Revisions	Date	By/Par

 Tél: (450) 979-4373 Fax: (450) 979-4626 www.exmweb.com		Flatness Aplatissement  Max 3.0mm Projection 
Customer Client	Date	
Drawn By Dessiné Par	BoxCad: BoxCad	Date 23-Sep-21
Material Matière	16 Ga Cold Rolled A1008 CS Type B (1.4mm)	
Color Couleur	Asa-61 Grey	Finish Fini Smooth
Description	Detail Rev.	
5300MC 27" x 13" x 10" Assembly		
Part Number Numéro Pièce	Rev.	1
5300MC271310	0	11

SEE BILL OF MATERIAL ON LAST PAGE

This drawing is confidential and must not be reproduced or used without the consent of EXM

Ce dessin est confidentiel et ne doit pas être reproduit ou utilisé sans le consentement de EXM

NOTE	
ITEM	DESCRIPTION
1	NEMA 3/3R Enclosure
2	C/W Standard ground studs on box and cover
3	W/O Standard door stiffener
4	C/W Special inner panel (Sold separately)
5	C/W Standard inner panel mounting studs

No.	Revisions	Date	By/Par

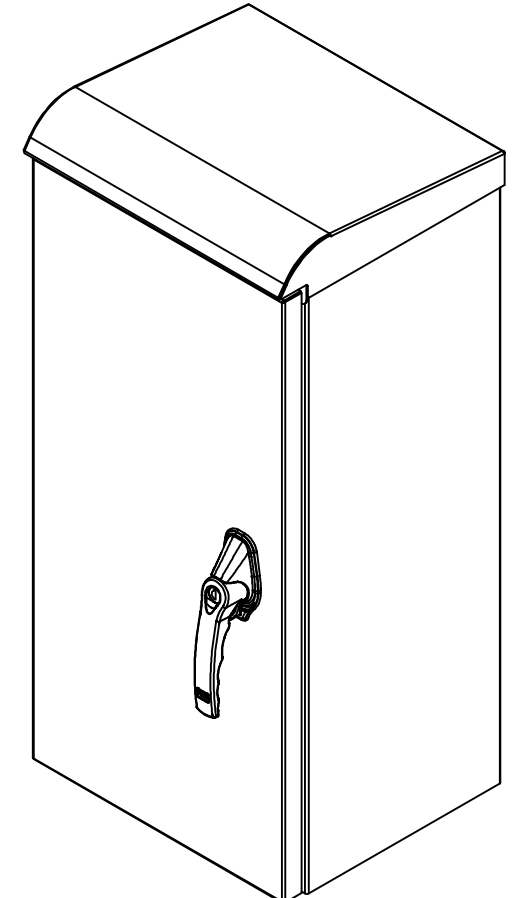

Isometric View



	Tél: (450) 979-4373 Fax: (450) 979-4626 www.exmweb.com	Flatness Aplatissement Max 3.0mm Projection
	Customer Client Drawn By / Dessiné Par: BoxCad: BoxCad Material / Matière: 16 Ga Cold Rolled A1008 CS Type B (1.4mm) Color / Couleur: Asa-61 Grey Finish / Fini: Smooth	Date Date: 23-Sep-21
Part Number / Numéro Pièce: 5300MC271310		Rev. 0 / 2 11

PACKING		
ITEM	QTY	DESCRIPTION
Cardboard sleeve	2	Top and Bottom
Cardboard strip	2	Between back of enclosure and inner panel
Plastic bag	1	To protect cover surface and inside gasket
Plastic strap - Black	2	To Squeeze the 2 cardboard sleeve together
Packaging label	1	White label with product number

Qty	Part Number	Rev	Description
1	5300MC271310IP	0	5300MC 27" x 13" Inner Panel Part
2	STK-K-01320	0	5412 ES Inner Panel Accessory Kit
1	5300MC271310C	0	5300MC 27" x 13" Cover
1	5300MC271310B	0	5300MC 27" x 13" x 10" Body
2	STK-Q-04050-10	8	M6 x 10mm Hexagon Socket Head Machine Screw with Nyseal

Parts List

This drawing is confidential and must not be reproduced or used without the consent of EXM

Ce dessin est confidentiel et ne doit pas être reproduit ou utilisé sans le consentement de EXM

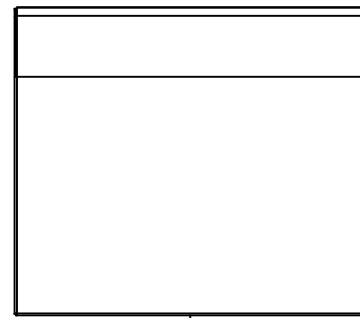

TOP

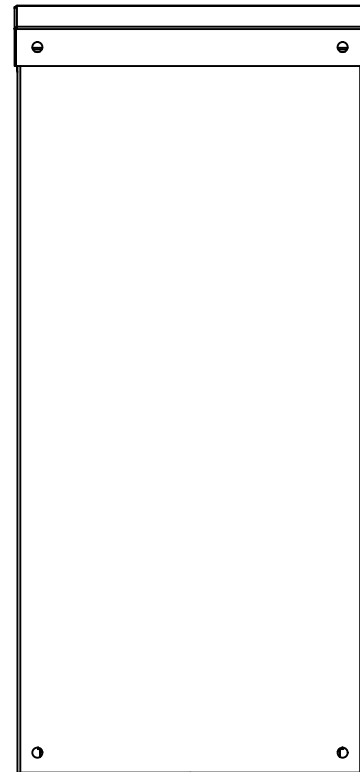

BACK

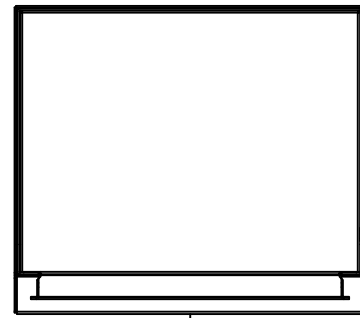

BOTTOM

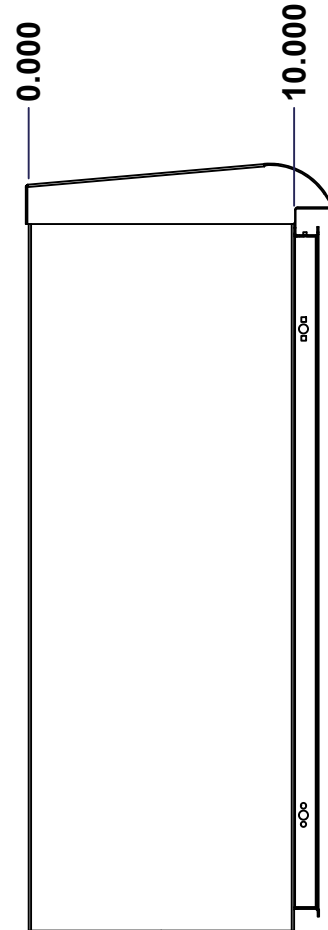

LEFT

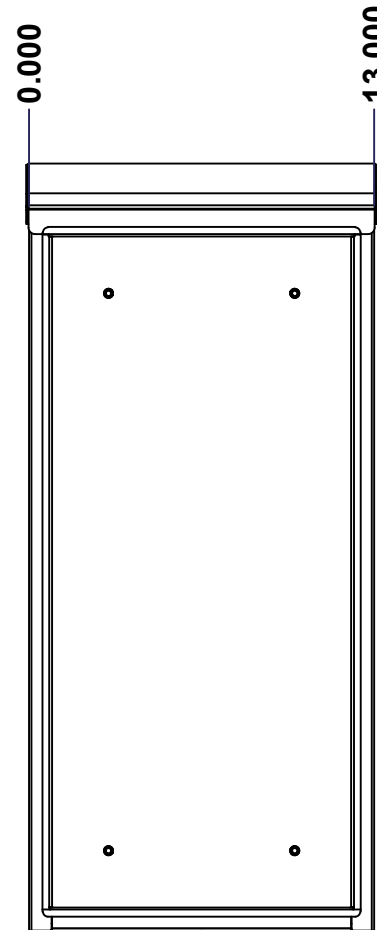

FRONT

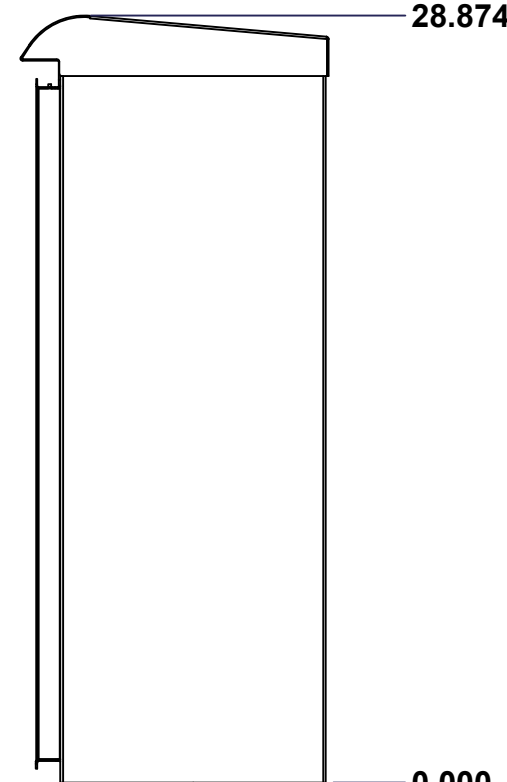

RIGHT

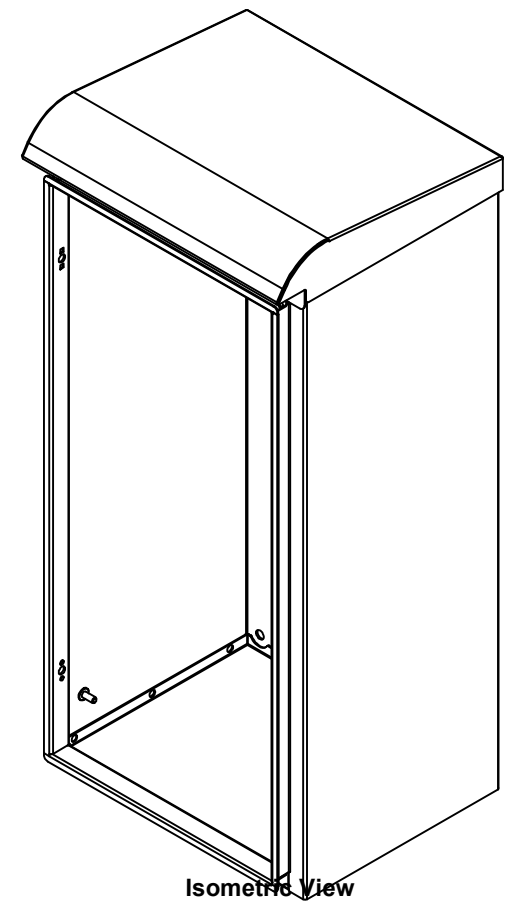

Isometric View

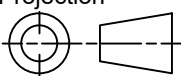

No.	Revisions	Date	By/Par

 Tél: (450) 979-4373 Fax: (450) 979-4626 www.exmweb.com		Flatness Aplatissement Max 3.0mm Projection 
Customer Client	Date	
Drawn By Dessiné Par	BoxCad: BoxCad	Date 23-Sep-21
Material Matière	16 Ga Cold Rolled A1008 CS Type B (1.4mm)	
Color Couleur	Asa-61 Grey	Finish Fini Smooth
Description	Detail Rev.	
5300MC 27" x 13" x 10" Body		
Part Number Numéro Pièce	Rev.	3
5300MC271310B	0	11

SEE BILL OF MATERIAL ON LAST PAGE

This drawing is confidential and must not be reproduced or used without the consent of EXM

Ce dessin est confidentiel et ne doit pas être reproduit ou utilisé sans le consentement de EXM

STANDARD FEATURES ARE NOT LISTED IN THIS HOLE TABLE			
HOLE TABLE - LEFT VIEW (CUSTOM FEATURE ONLY)			
CUT-OUT	XDIM	YDIM	DESCRIPTION
1	8.500	2.000	GND STUD M6 x 16mm (Inside)

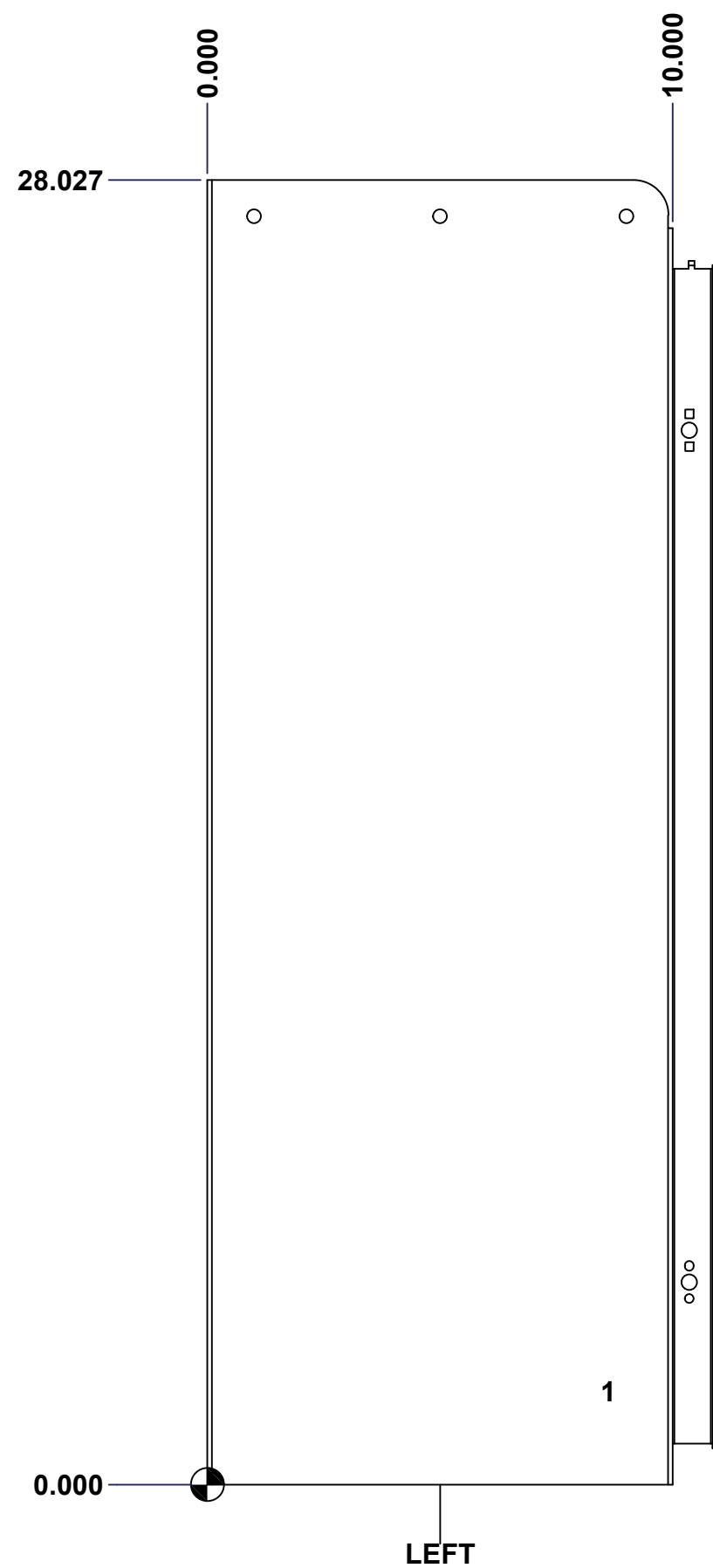

	Description	Status
	5300MC 27" x 13" x 10" Body	(NULL)
	Part Number Numéro Pièce	Rev.
	5300MC271310B	0 / 4
		11

This drawing is confidential and must not be reproduced or used without the consent of EXM

Ce dessin est confidentiel et ne doit pas être reproduit ou utilisé sans le consentement de EXM

STANDARD FEATURES ARE NOT LISTED IN THIS HOLE TABLE

HOLE TABLE - BACK VIEW (CUSTOM FEATURE ONLY)

CUT-OUT	XDIM	YDIM	DESCRIPTION
1	3.000	3.000	IP STUD M8 x 35mm (Inside)
2	3.000	24.000	IP STUD M8 x 35mm (Inside)
3	10.000	24.000	IP STUD M8 x 35mm (Inside)
4	10.000	3.000	IP STUD M8 x 35mm (Inside)

5	12.250	0.750	RND Ø0.390
6	12.250	27.321	RND Ø0.500
7	0.750	27.321	RND Ø0.500
8	0.750	0.750	RND Ø0.390

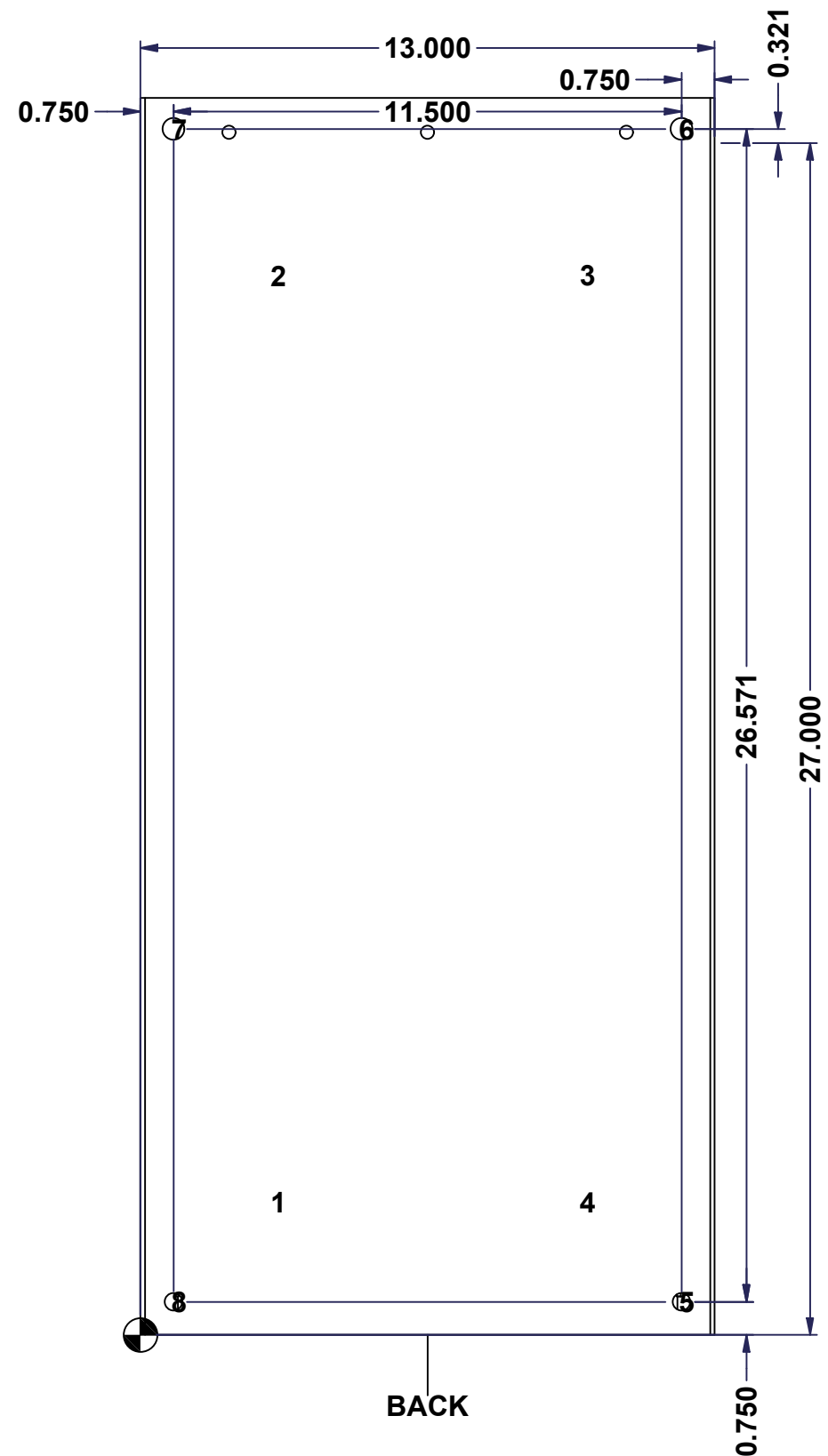

	Description	Status	
	5300MC 27" x 13" x 10" Body	(NULL)	
	Part Number Numéro Pièce	Rev.	5
	5300MC271310B	0	11

This drawing is confidential and must not be reproduced or used without the consent of EXM

Ce dessin est confidentiel et ne doit pas être reproduit ou utilisé sans le consentement de EXM

No.	Revisions	Date	By/Par

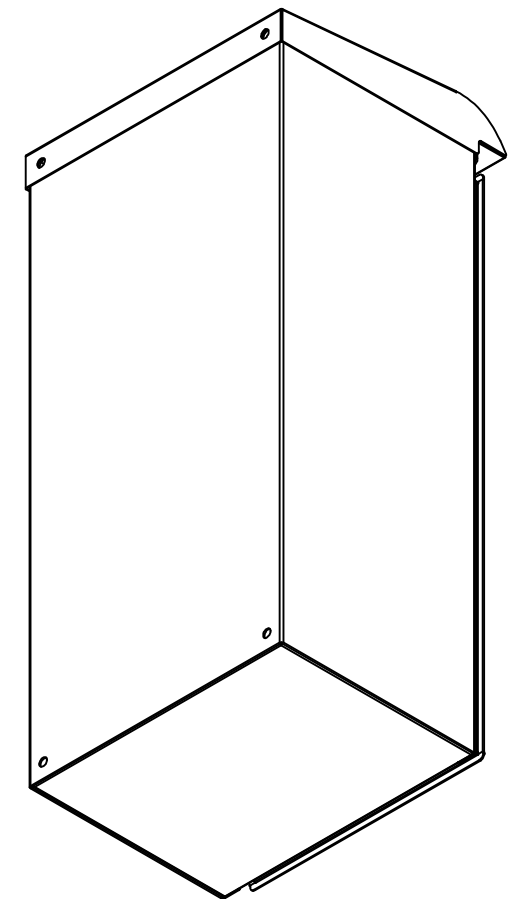

Isometric View



EXM
www.exmweb.com

Tél: (450) 979-4373
Fax: (450) 979-4626

Flatness
Aplatissement
Max 3.0mm

Projection

Customer Client	Date
Drawn By Dessiné Par	Date 23-Sep-21
Material Matière	16 Ga Cold Rolled A1008 CS Type B (1.4mm)

Color Couleur	Asa-61 Grey	Finish Fini	Smooth
Description		Detail Rev.	
5300MC 27" x 13" x 10" Body			
Part Number Numéro Pièce	Rev.	6	
5300MC271310B	0	11	

Qty	Part Number	Rev	Description
1	STK-Q-16080	0	Ground Stud M6 x 16mm Steel
1	STK-P-02400S	0	Powder Paint (Asa-61 Grey / Smooth)
1	5300MC271310BT-P	0	5300MC 13" x 10" Bottom Part
4	STK-Q-16005	1	Stud M8 x 35 (No Paint Cap Required)
1	5300MC271310T-P	0	5300MC 13" x 8" Top Part
1	5300MC271310B-P	0	5300MC 27" x 13" x 10" Body Part
Parts List			

This drawing is confidential and must not be reproduced or used without the consent of EXM

Ce dessin est confidentiel et ne doit pas être reproduit ou utilisé sans le consentement de EXM

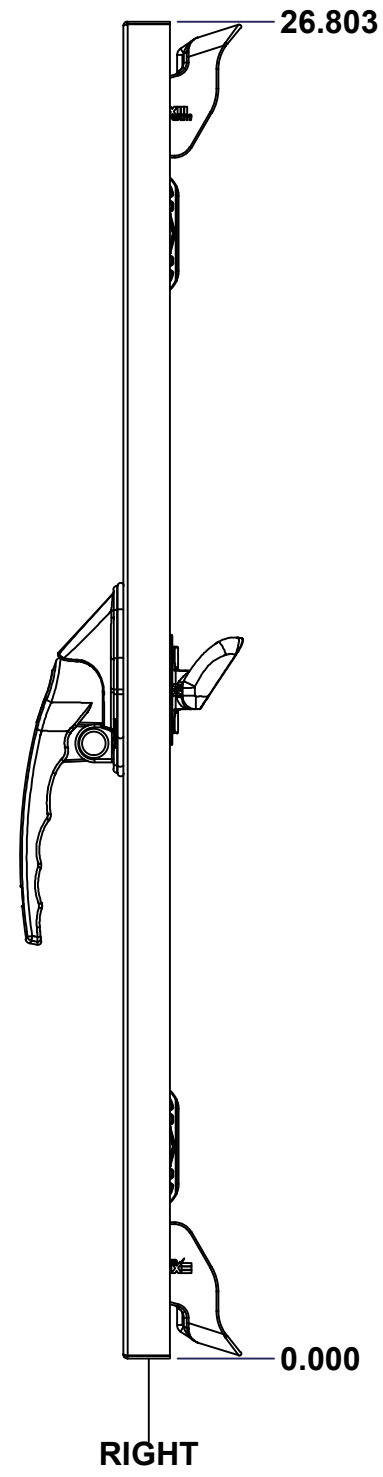
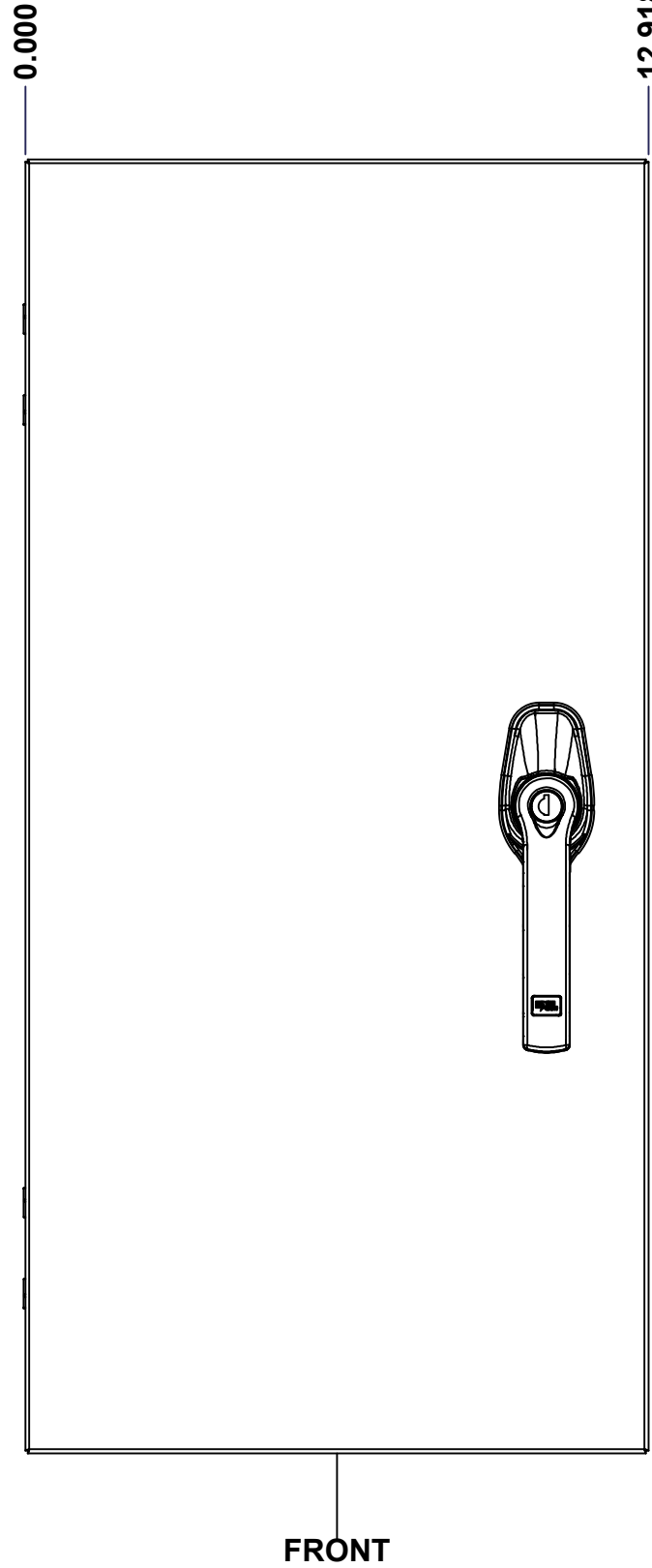
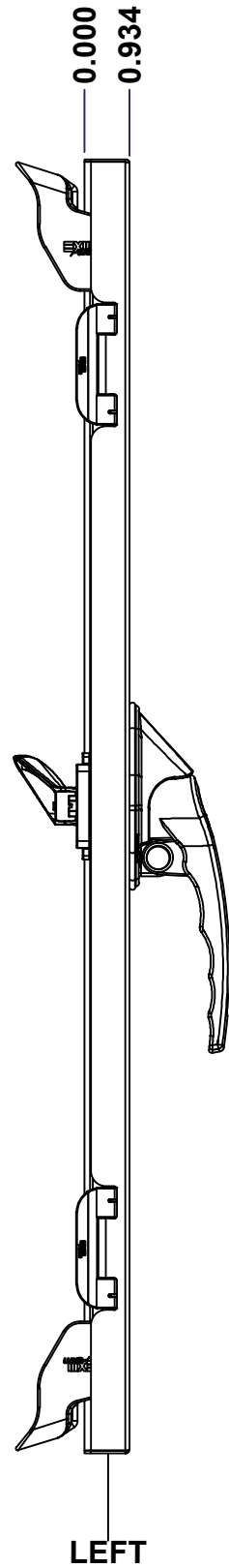
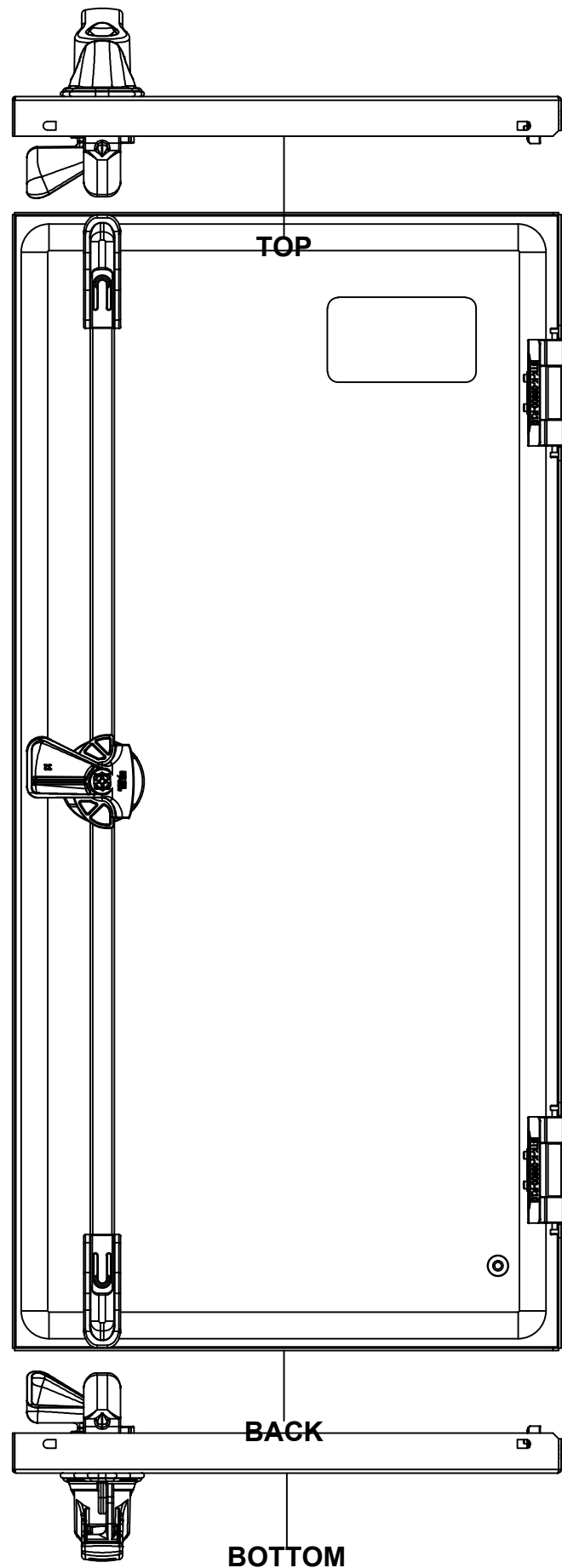

No.	Revisions	Date	By/Par

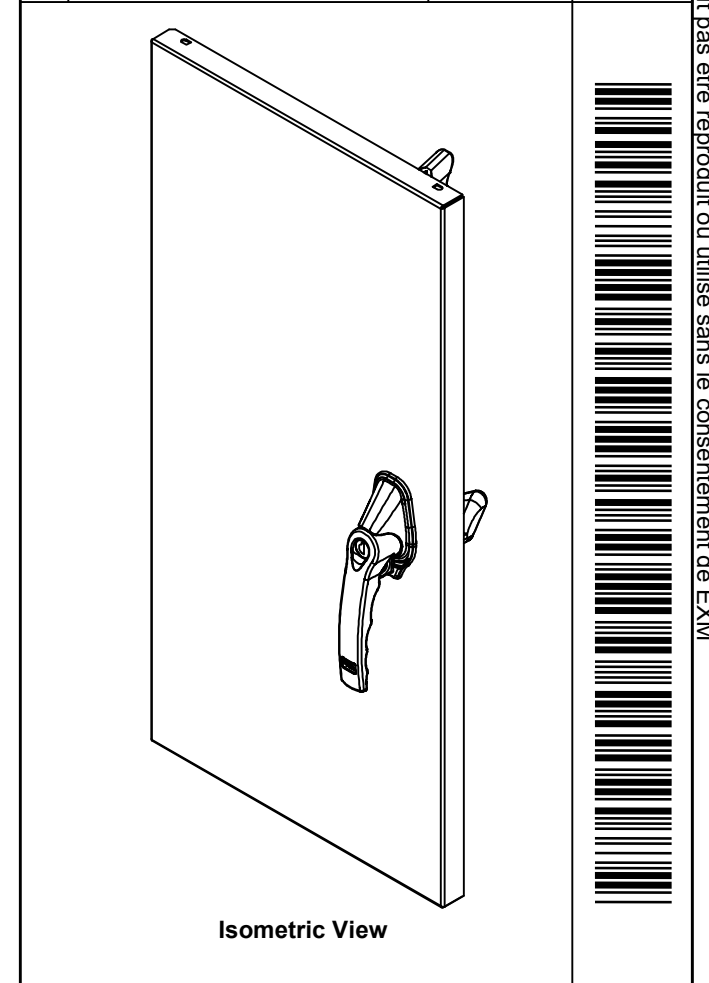

	Flatness Aplatissement Max 3.0mm
	Projection
Customer Client Drawn By / Dessiné Par: BoxCad: BoxCad Material / Matière: 16 Ga Cold Rolled A1008 CS Type B (1.4mm)	Date Date: 23-Sep-21
Color / Couleur: Asa-61 Grey Finish / Fini: Smooth	Detail Rev.
Description: 5300MC 27" x 13" Cover	Part Number / Numéro Pièce: 5300MC271310C
Rev. 0	Rev. 7 11

SEE BILL OF MATERIAL ON LAST PAGE

This drawing is confidential and must not be reproduced or used without the consent of EXM

Ce dessin est confidentiel et ne doit pas être reproduit ou utilisé sans le consentement de EXM

STANDARD FEATURES ARE NOT LISTED IN THIS HOLE TABLE

HOLE TABLE - FRONT VIEW (CUSTOM FEATURE ONLY)

CUT-OUT	XDIM	YDIM	DESCRIPTION
1	10.803	21.896	CLOSING BAR STUD (Inside)
2	10.803	4.907	CLOSING BAR STUD (Inside)

3	1.486	2.000	GND STUD M6 x 16mm (Inside)
4	3.750	23.803	LABEL_EXM (Inside)
5	10.803	13.402	885 ESL2A-APHK

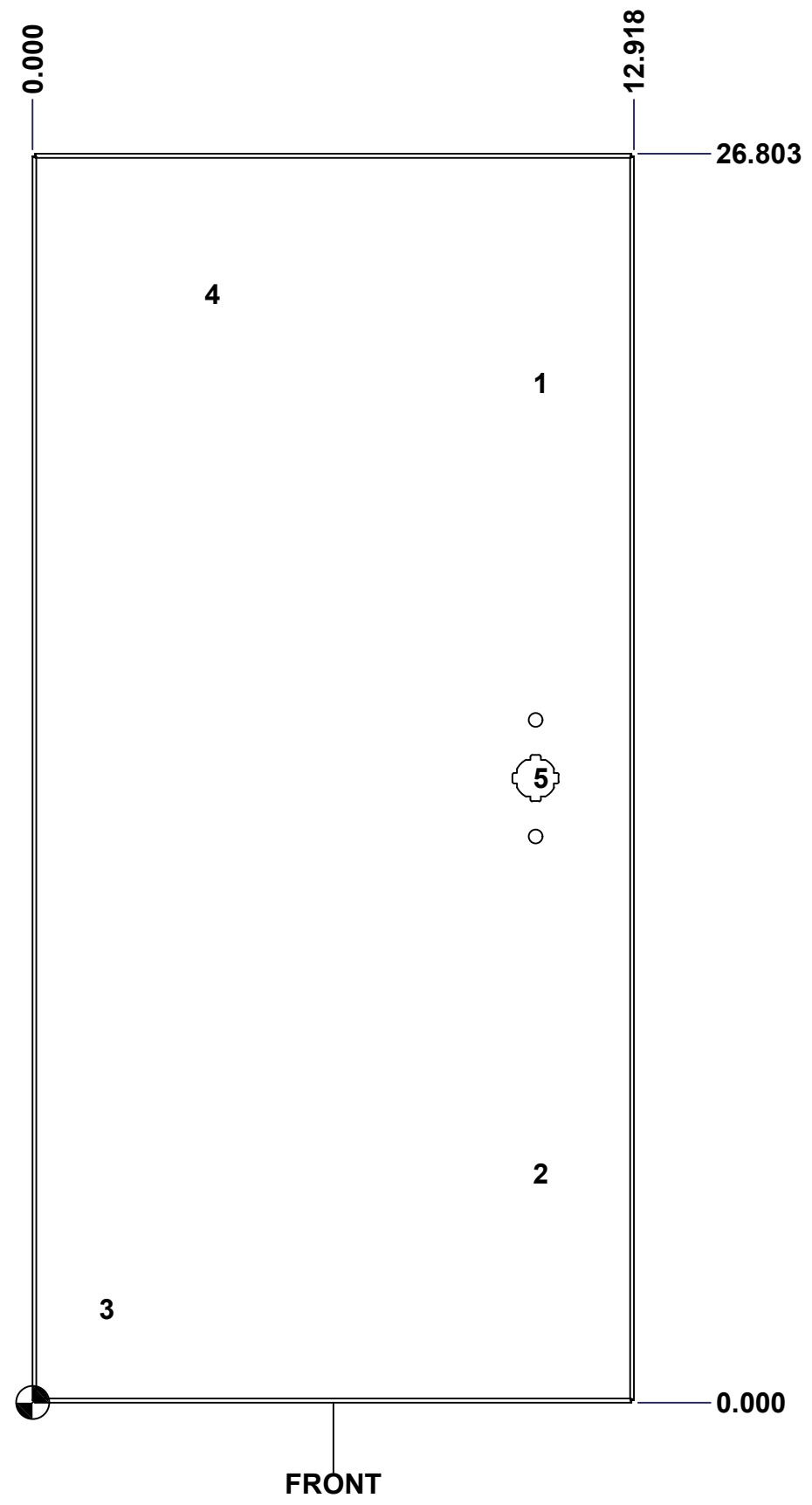

	Description	Status
	5300MC 27" x 13" Cover	(NULL)
	Part Number Numéro Pièce	Rev.
	5300MC271310C	0 / 8
		11

This drawing is confidential and must not be reproduced or used without the consent of EXM

Ce dessin est confidentiel et ne doit pas être reproduit ou utilisé sans le consentement de EXM

No.	Revisions	Date	By/Par

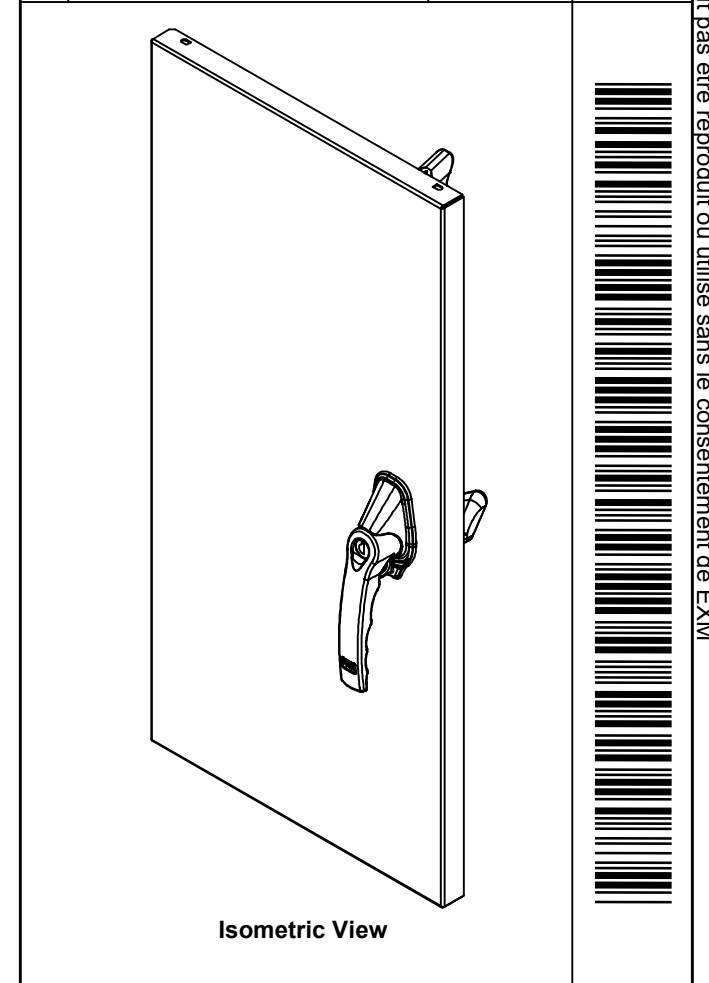

1	5300MC271310LBAR	0	5412 ES - Lower Closing Bar (Length = 11.5")
2	STK-Q-90042	4	5412 ES - Cabinet Closing Bar End (Small)
1	5300MC271310UBAR	0	5412 ES - Upper Closing Bar (Length = 11.5")
1	STK-Q-50536	13	5412 ES - Handle Cam Clockwise (Grip 32mm)
1	STK-Q-90051	3	5412 ES - Handle Cam Spacer
1	885ESL2A-APHK	6	885 ESL2A-APHK - Zinc Die Cast L-Handle Padlockable Assy
1	STK-S-00100	0	3.5" x 2" Silver Milar Flexcon Sticker
1	STK-Q-16080	0	Ground Stud M6 x 16mm Steel
1	STK-P-02400S	0	Powder Paint (Asa-61 Grey / Smooth)
2	STK-Q-16405	6	Guide Stud - Small (No Paint Cap Required)
1	5300MC271310C-G	0	5300MC 27" x 13" Cover Gasket
1	5300MC271310C-P	0	5300MC 27" x 13" Cover Part
2	STK-K-09800	10	5412 ES Hinge with 2 Captive Hinge Pins
Qty	Part Name	Rev	Description
Parts List			

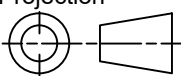
 Tél: (450) 979-4373 Fax: (450) 979-4626 www.exmweb.com	Flatness Aplatissement	Max 3.0mm
	Projection	
Customer Client	Date	
Drawn By Dessiné Par	BoxCad: BoxCad	Date 23-Sep-21
Material Matière	16 Ga Cold Rolled A1008 CS Type B (1.4mm)	
Color Couleur	Asa-61 Grey	Finish Fini Smooth
Description	Detail Rev.	
5300MC 27" x 13" Cover		
Part Number Numéro Pièce	Rev.	9
5300MC271310C	0	11

This drawing is confidential and must not be reproduced or used without the consent of EXM

Ce dessin est confidentiel et ne doit pas être reproduit ou utilisé sans le consentement de EXM

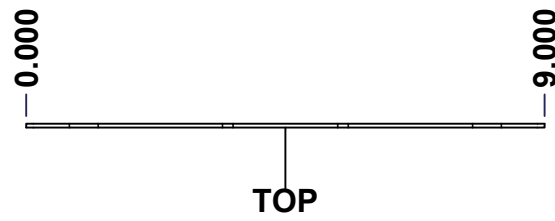

TOP

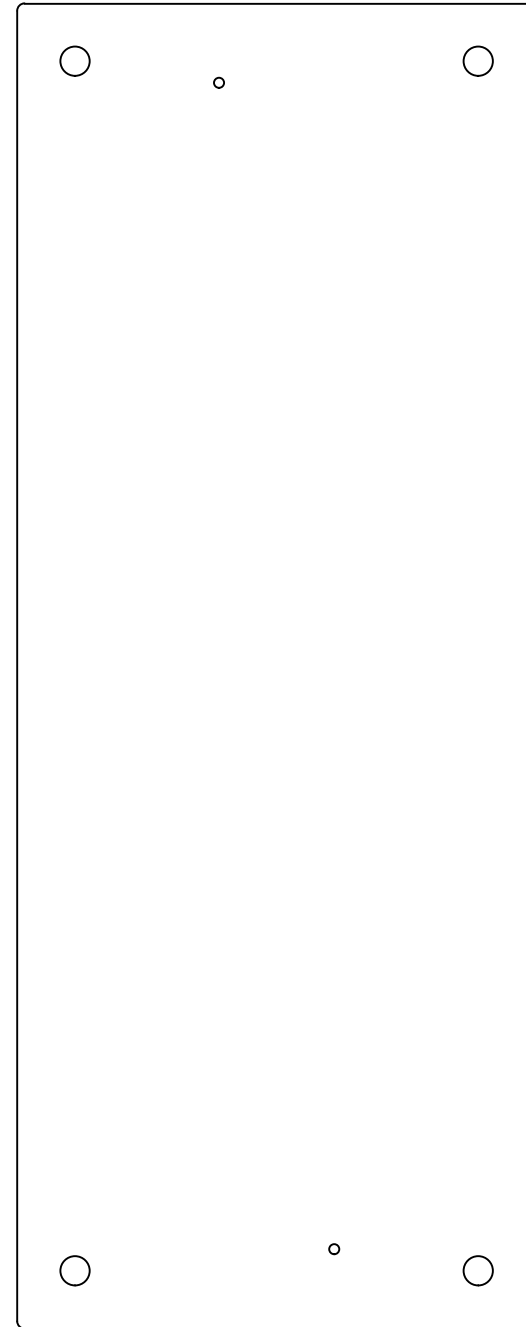

FRONT

23.000

0.000

RIGHT

No.	Revisions	Date	By/Par

Isometric View

Tél: (450) 979-4373 Fax: (450) 979-4626 www.exmweb.com		Flatness Aplatissement Max 3.0mm Projection
Customer Client	Date	
Drawn By Dessiné Par	BoxCad: BoxCad	Date 23-Sep-21
Material Matière	14 Ga Galvanized	
Color Couleur	Unpainted	Finish Fini Unpainted
Description	Detail Rev.	
5300MC 27" x 13" Inner Panel Part		
Part Number Numéro Pièce	Rev.	10
5300MC271310IP	0	11

SEE BILL OF MATERIAL ON LAST PAGE

This drawing is confidential and must not be reproduced or used without the consent of EXM

Ce dessin est confidentiel et ne doit pas être reproduit ou utilisé sans le consentement de EXM

No.	Revisions	Date	By/Par

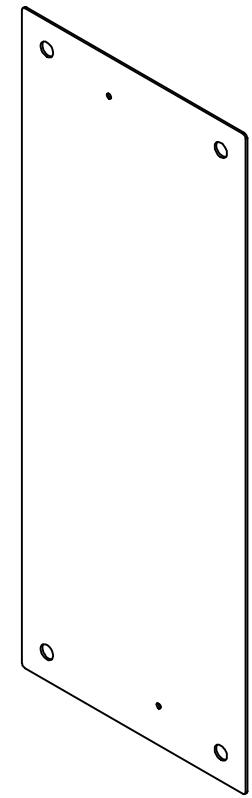

Isometric View

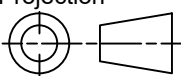

 Tél: (450) 979-4373 Fax: (450) 979-4626 www.exmweb.com		Flatness Aplatissement Max 3.0mm
Customer Client		Projection 
Drawn By / Dessiné Par: BoxCad: BoxCad		Date: 23-Sep-21
Material / Matière: 14 Ga Galvanized		
Color / Couleur: Unpainted	Finish / Fini: Unpainted	
Description: 5300MC 27" x 13" Inner Panel Part		Detail Rev.
Part Number / Numéro Pièce: 5300MC271310IP		Rev. 0 / 11

Qty	Part Number	Rev	Description
1	5300MC271310IP-P	0	5300MC 27" x 13" Inner Panel Part
Parts List			