

This drawing is confidential and must not be reproduced or used without the consent of EXM

Ce dessin est confidentiel et ne doit pas être reproduit ou utilisé sans le consentement de EXM

No.	Revisions	Date	By/Par

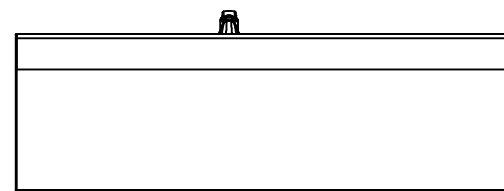

TOP

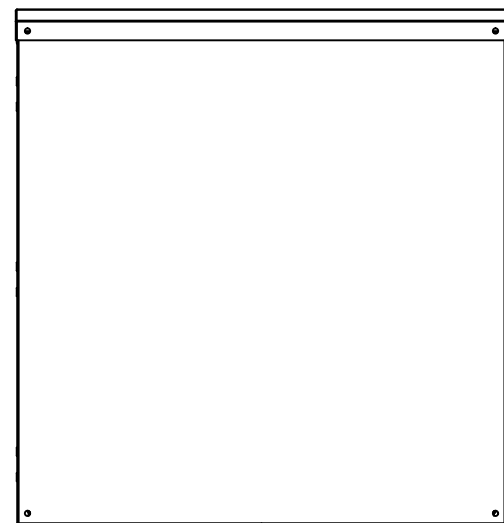

BACK

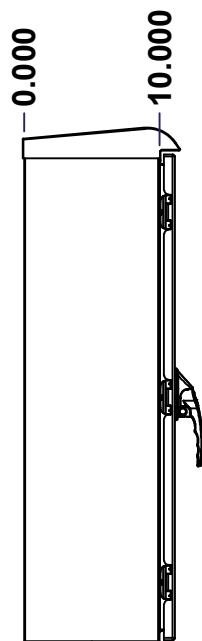

LEFT

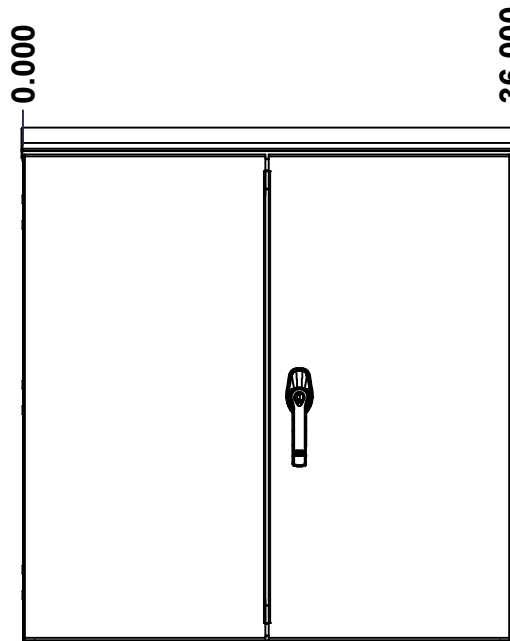

FRONT

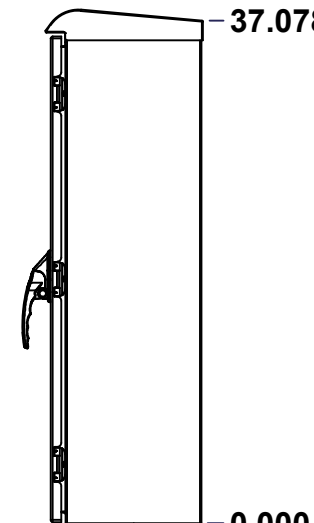

RIGHT

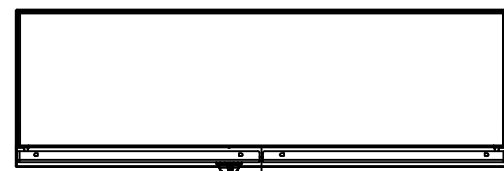

BOTTOM

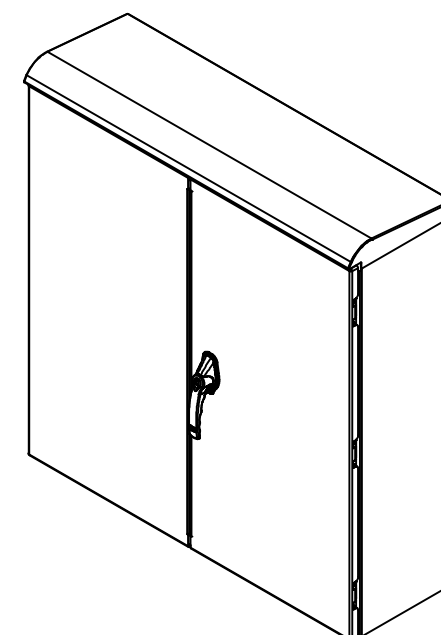

Isometric View



Tél: (450) 979-4373  
 Fax: (450) 979-4626  
[www.exmweb.com](http://www.exmweb.com)

Flatness  
 Aplatissement  
 Max 3.0mm  
 Projection

Customer Client  
 Date  
 Drawn By Dessiné Par BoxCad: BoxCad  
 Date 23-Sep-21

Material Matière 14 Ga Cold Rolled A1008 CS Type B (1.7mm)

Color Couleur Asa-61 Grey  
 Finish Fini Smooth

Description 5300MCDD 36" x 36" x 10" Assembly  
 Detail Rev.

Part Number Numéro Pièce 5300MCDD363610  
 Rev. 0  
 1  
 15

SEE BILL OF MATERIAL ON LAST PAGE

This drawing is confidential and must not be reproduced or used without the consent of EXM

Ce dessin est confidentiel et ne doit pas être reproduit ou utilisé sans le consentement de EXM

NOTE	
ITEM	DESCRIPTION
1	NEMA 3/3R Enclosure
2	C/W Standard ground studs on box and cover
3	W/O Standard door stiffener
4	C/W Special inner panel (Sold separately)
5	C/W Standard inner panel mounting studs

No.	Revisions	Date	By/Par

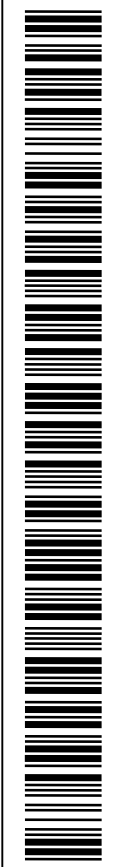
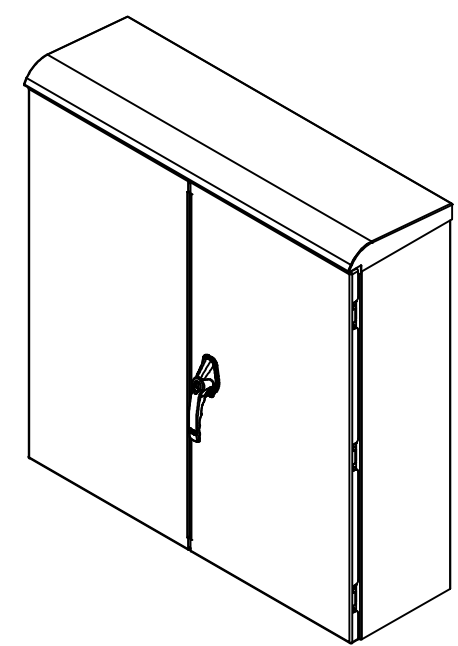

Isometric View



Tél: (450) 979-4373  
 Fax: (450) 979-4626  
[www.exmweb.com](http://www.exmweb.com)

Flatness  
Aplatissement  
Max 3.0mm  
Projection

Customer Client	Date
Drawn By / Dessiné Par: BoxCad: BoxCad	Date: 23-Sep-21
Material / Matière: 14 Ga Cold Rolled A1008 CS Type B (1.7mm)	

Color / Couleur: Asa-61 Grey	Finish / Fini: Smooth
Description: 5300MCDD 36" x 36" x 10" Assembly	
Part Number / Numéro Pièce: <b>5300MCDD363610</b>	Rev. 0

PACKING		
ITEM	QTY	DESCRIPTION
Cardboard sleeve	2	Top and Bottom
Cardboard strip	2	Between back of enclosure and inner panel
Plastic bag	1	To protect cover surface and inside gasket
Plastic strap - Black	2	To Squeeze the 2 cardboard sleeve together
Packaging label	1	White label with product number

Qty	Part Number	Rev	Description
1	5300MCDD363610IP	0	5300MCDD 36" x 36" Inner Panel Part
4	STK-K-01320	0	5412 ES Inner Panel Accessory Kit
1	5300MCDD363610LD	0	5300MCDD 36" x 36" Lock Door
1	5300MCDD363610FD	0	5300MCDD 36" x 36" Flange Door
1	5300MCDD363610B	0	5300MCDD 36" x 36" x 10" Body
6	STK-Q-04050-10	8	M6 x 10mm Hexagon Socket Head Machine Screw with Nyseal

Parts List

This drawing is confidential and must not be reproduced or used without the consent of EXM

Ce dessin est confidentiel et ne doit pas être reproduit ou utilisé sans le consentement de EXM

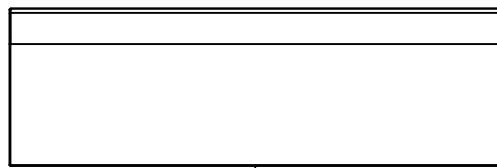

TOP

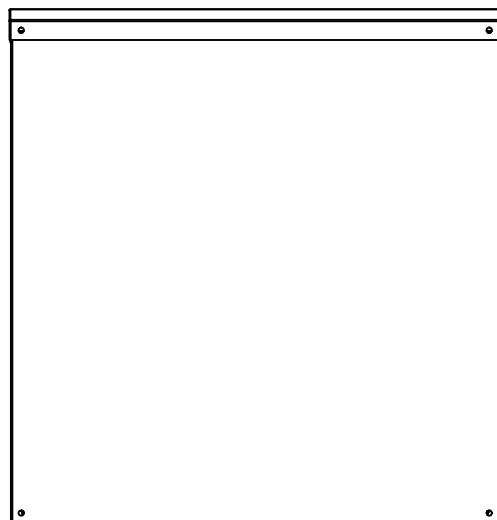

BACK

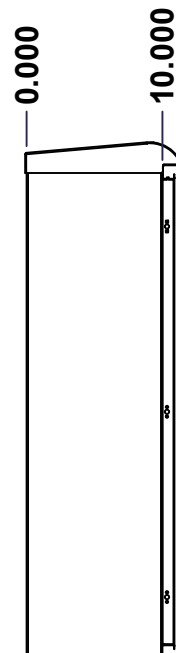

LEFT

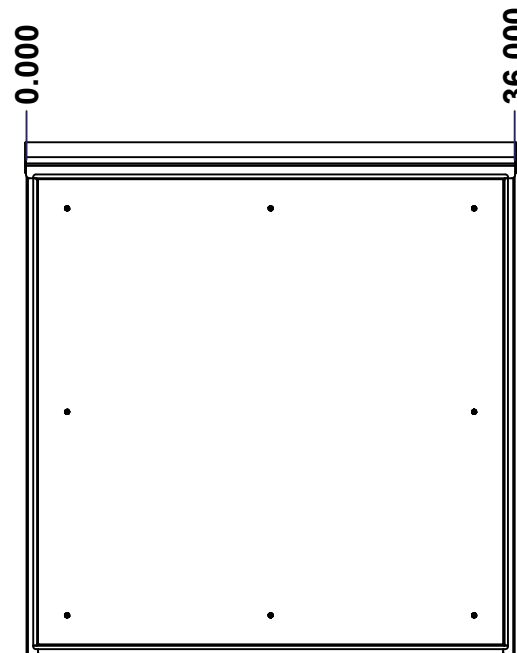

FRONT

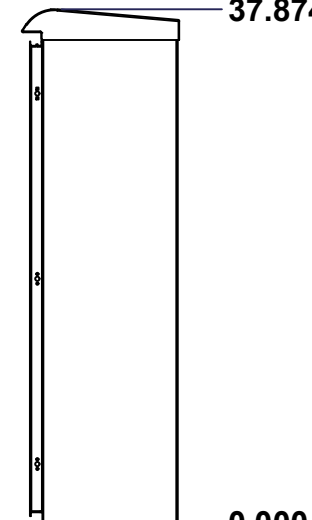

RIGHT



BOTTOM

No.	Revisions	Date	By/Par

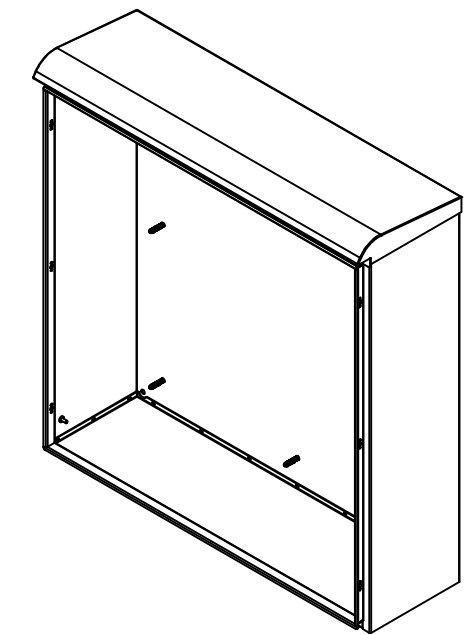

Isometric View



Tél: (450) 979-4373  
 Fax: (450) 979-4626  
[www.exmweb.com](http://www.exmweb.com)

Flatness  
Aplatissement

Max 3.0mm

Projection

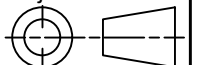

Customer Client	Date
Drawn By Dessiné Par BoxCad: BoxCad	Date 23-Sep-21
Material Matière 14 Ga Cold Rolled A1008 CS Type B (1.7mm)	
Color Couleur Asa-61 Grey	Finish Fini Smooth
Description 5300MCDD 36" x 36" x 10" Body	Detail Rev.
Part Number Numéro Pièce <b>5300MCDD363610B</b>	Rev. 3
	0

SEE BILL OF MATERIAL ON LAST PAGE

This drawing is confidential and must not be reproduced or used without the consent of EXM

Ce dessin est confidentiel et ne doit pas être reproduit ou utilisé sans le consentement de EXM

<b>STANDARD FEATURES ARE NOT LISTED IN THIS HOLE TABLE</b>			
<b>HOLE TABLE - RIGHT VIEW (CUSTOM FEATURE ONLY)</b>			
CUT-OUT	XDIM	YDIM	DESCRIPTION
1	8.500	2.000	GND STUD M6 x 16mm (Inside)

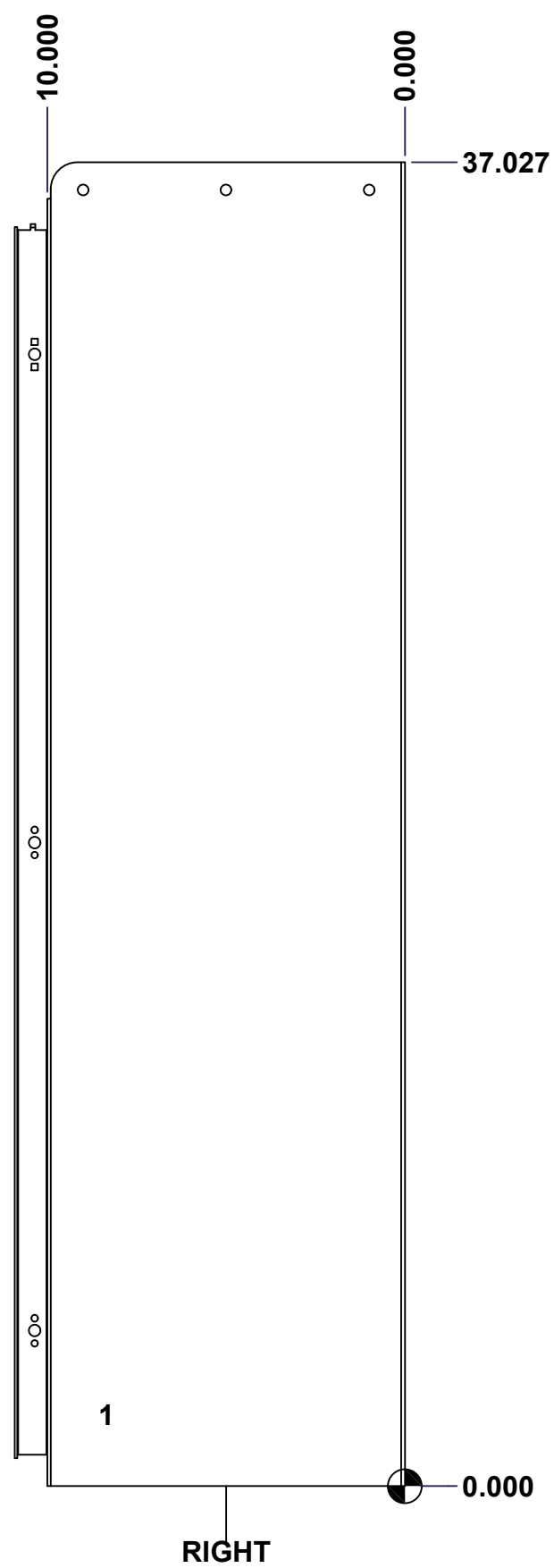

	Description	Status
	5300MCDD 36" x 36" x 10" Body	(NULL)
	Part Number Numéro Pièce	Rev.
	<b>5300MCDD363610B</b>	<b>0</b> / 4
		15

This drawing is confidential and must not be reproduced or used without the consent of EXM

Ce dessin est confidentiel et ne doit pas être reproduit ou utilisé sans le consentement de EXM

<b>STANDARD FEATURES ARE NOT LISTED IN THIS HOLE TABLE</b>			
<b>HOLE TABLE - LEFT VIEW (CUSTOM FEATURE ONLY)</b>			
CUT-OUT	XDIM	YDIM	DESCRIPTION
1	8.500	2.000	GND STUD M6 x 16mm (Inside)

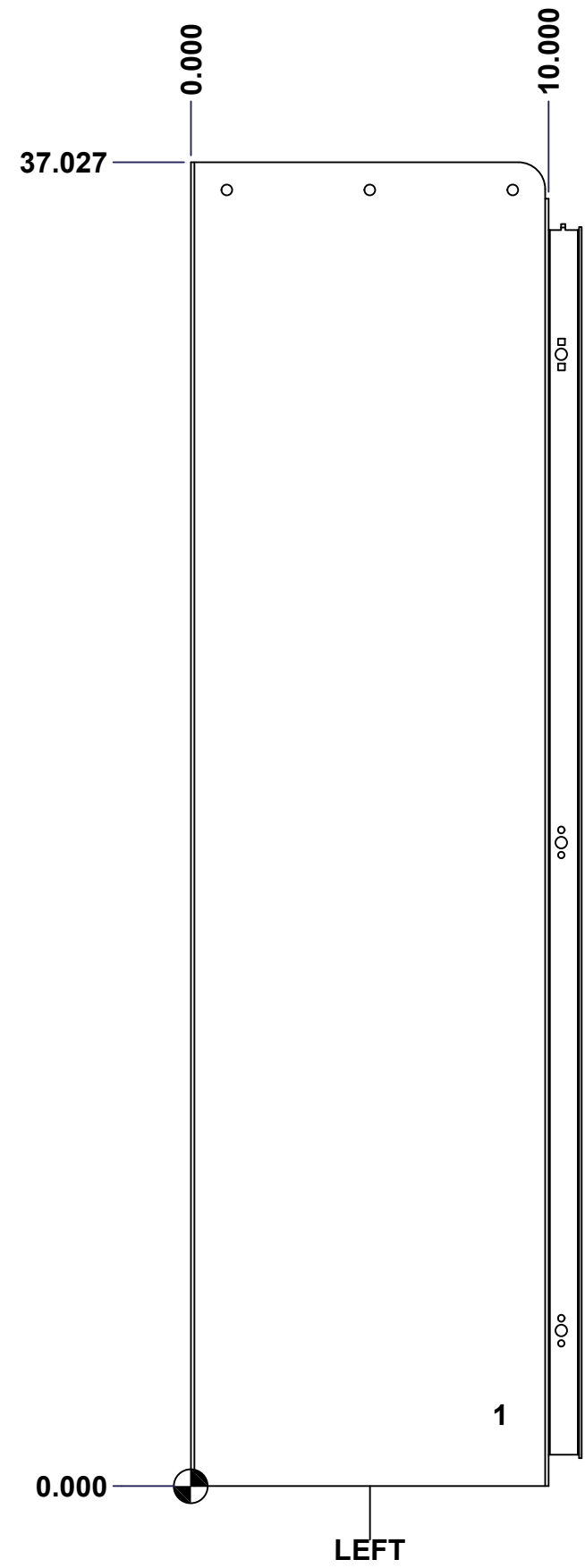

	Description	Status
	5300MCDD 36" x 36" x 10" Body	(NULL)
Part Number Numéro Pièce <b>5300MCDD363610B</b>	Rev.	5
	<b>0</b>	15

This drawing is confidential and must not be reproduced or used without the consent of EXM

Ce dessin est confidentiel et ne doit pas être reproduit ou utilisé sans le consentement de EXM

**STANDARD FEATURES ARE NOT LISTED IN THIS HOLE TABLE**

**HOLE TABLE - BACK VIEW (CUSTOM FEATURE ONLY)**

CUT-OUT	XDIM	YDIM	DESCRIPTION
1	3.000	3.000	IP STUD M8 x 35mm (Inside)
2	3.000	33.000	IP STUD M8 x 35mm (Inside)
3	33.000	33.000	IP STUD M8 x 35mm (Inside)
4	33.000	3.000	IP STUD M8 x 35mm (Inside)
5	3.000	18.000	IP STUD M8 x 35mm (Inside)
6	33.000	18.000	IP STUD M8 x 35mm (Inside)
7	18.000	3.000	IP STUD M8 x 35mm (Inside)
8	18.000	33.000	IP STUD M8 x 35mm (Inside)
-----			
9	35.250	0.750	RND Ø0.390
10	35.250	36.321	RND Ø0.500
11	0.750	36.321	RND Ø0.500
12	0.750	0.750	RND Ø0.390

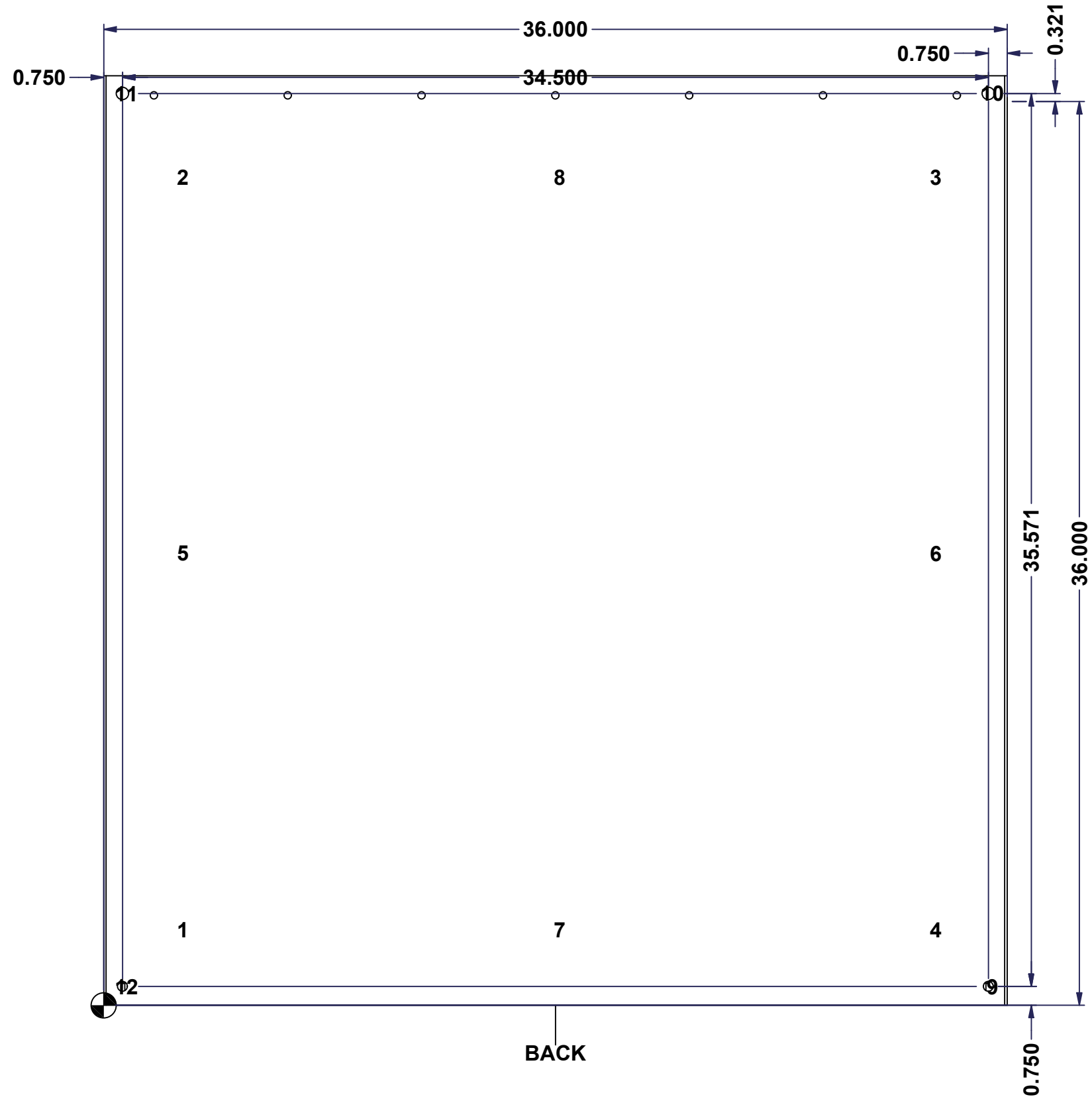



	Description	Status
	5300MCDD 36" x 36" x 10" Body	(NULL)
Part Number Numéro Pièce <b>5300MCDD363610B</b>	Rev.	6
	<b>0</b>	15

This drawing is confidential and must not be reproduced or used without the consent of EXM

Ce dessin est confidentiel et ne doit pas être reproduit ou utilisé sans le consentement de EXM

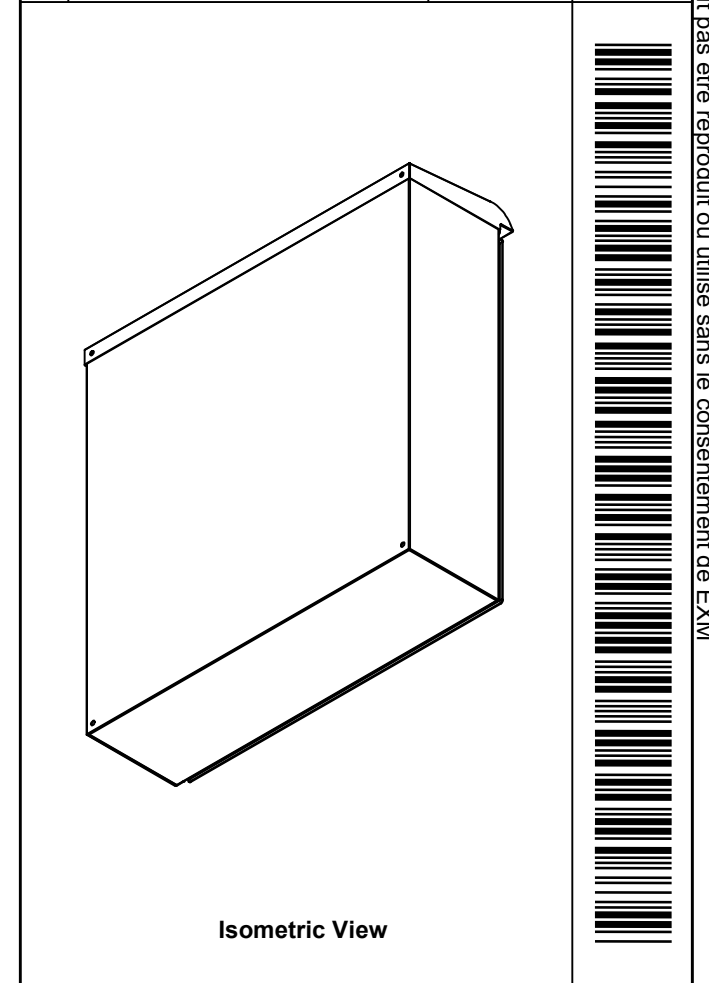
No.	Revisions	Date	By/Par

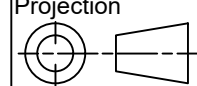

 Tél: (450) 979-4373 Fax: (450) 979-4626 <a href="http://www.exmweb.com">www.exmweb.com</a>		Flatness Aplatissement Max 3.0mm Projection 
Customer Client	Date	
Drawn By Dessiné Par	BoxCad: BoxCad	Date 23-Sep-21
Material Matière	14 Ga Cold Rolled A1008 CS Type B (1.7mm)	
Color Couleur	Asa-61 Grey	Finish Fini Smooth
Description		Detail Rev.
5300MCDD 36" x 36" x 10" Body		
Part Number Numéro Pièce	Rev.	7
<b>5300MCDD363610B</b>	<b>0</b>	15

Qty	Part Number	Rev	Description
2	STK-Q-16080	0	Ground Stud M6 x 16mm Steel
1	STK-P-02400S	0	Powder Paint (Asa-61 Grey / Smooth)
1	5300MCDD363610BT-P	0	5300MCDD 36" x 36" Bottom Part
8	STK-Q-16005	1	Stud M8 x 35 (No Paint Cap Required)
1	5300MCDD363610T-P	0	5300MCDD 36" x 8" Top Part
1	5300MCDD363610B-P	0	5300MCDD 36" x 36" x 10" Body Part
Parts List			

This drawing is confidential and must not be reproduced or used without the consent of EXM

Ce dessin est confidentiel et ne doit pas être reproduit ou utilisé sans le consentement de EXM

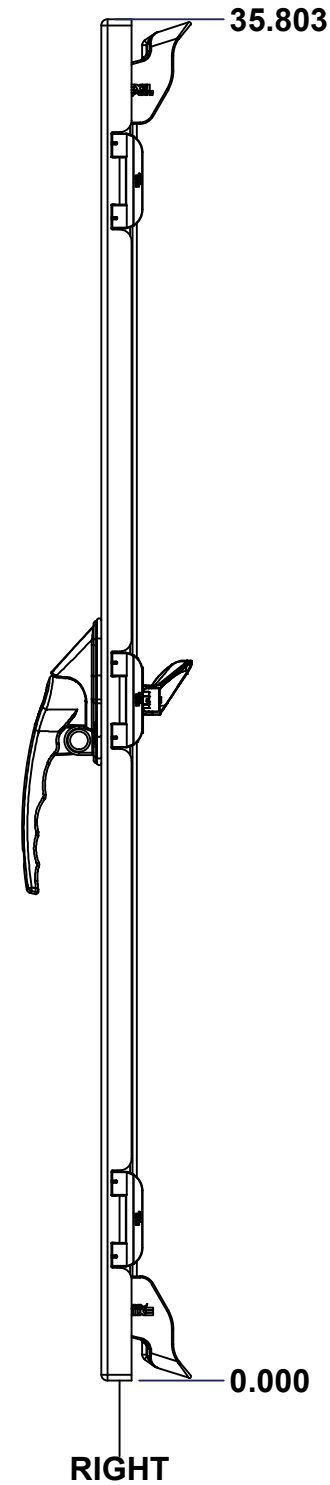
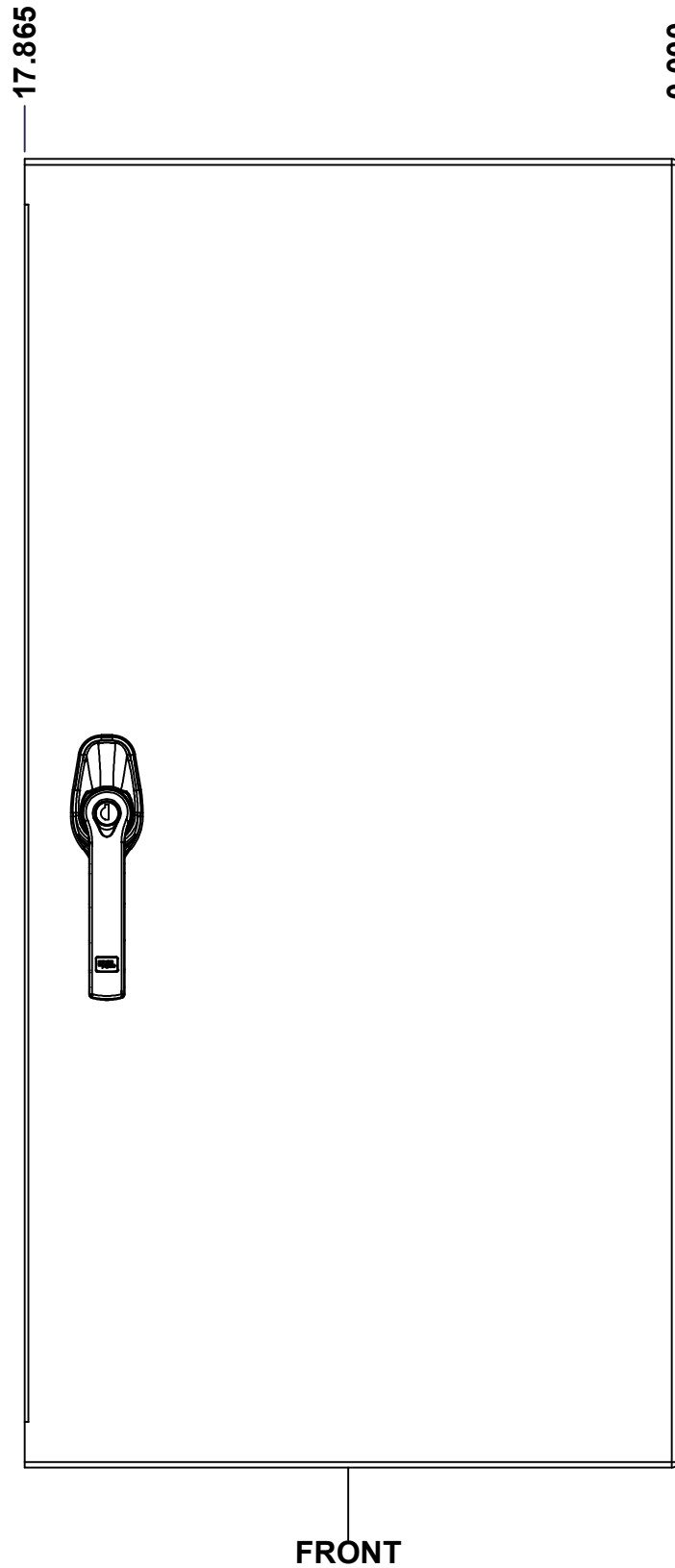
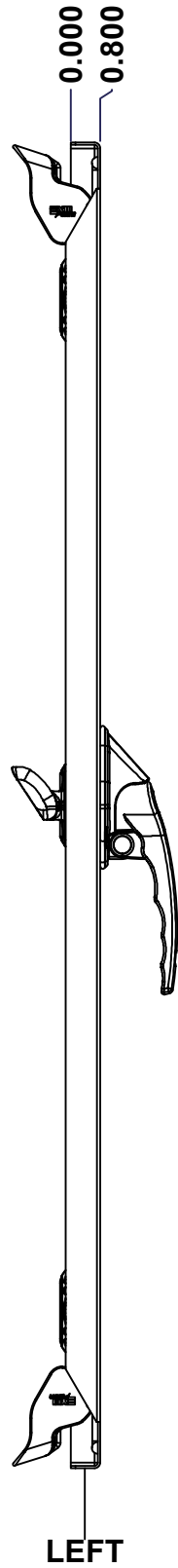
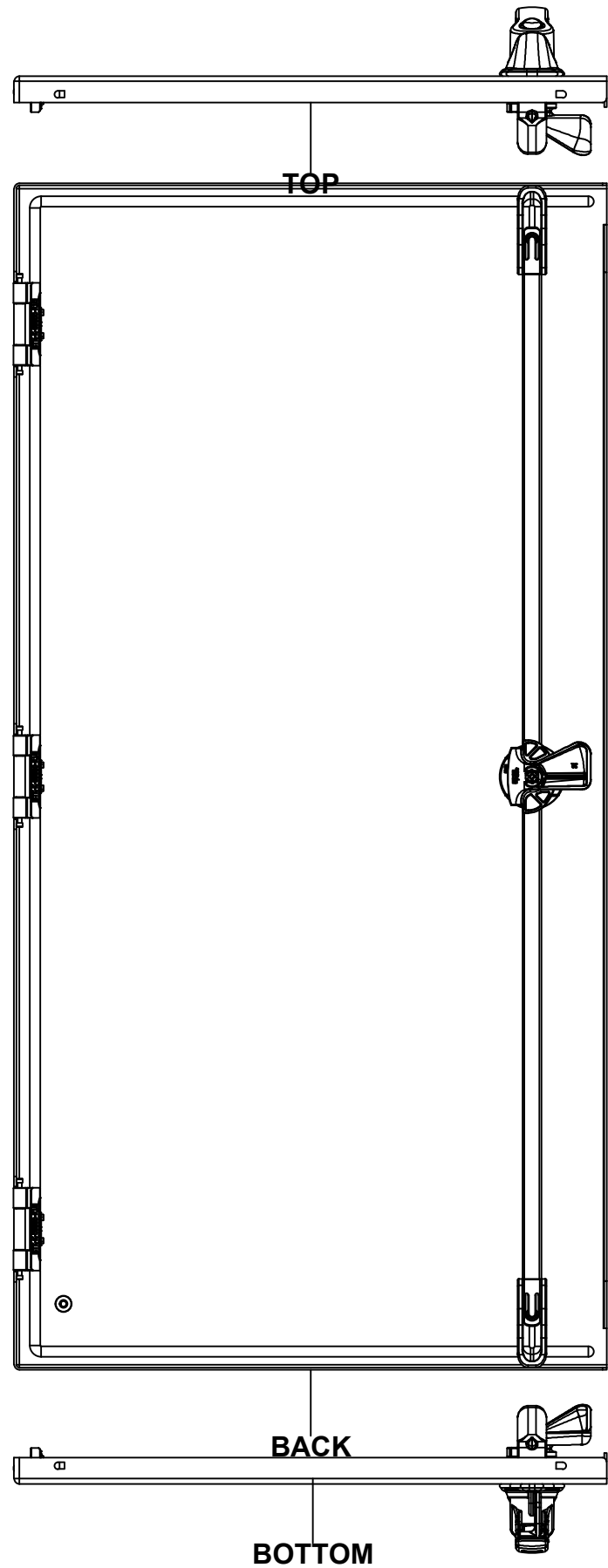

No.	Revisions	Date	By/Par

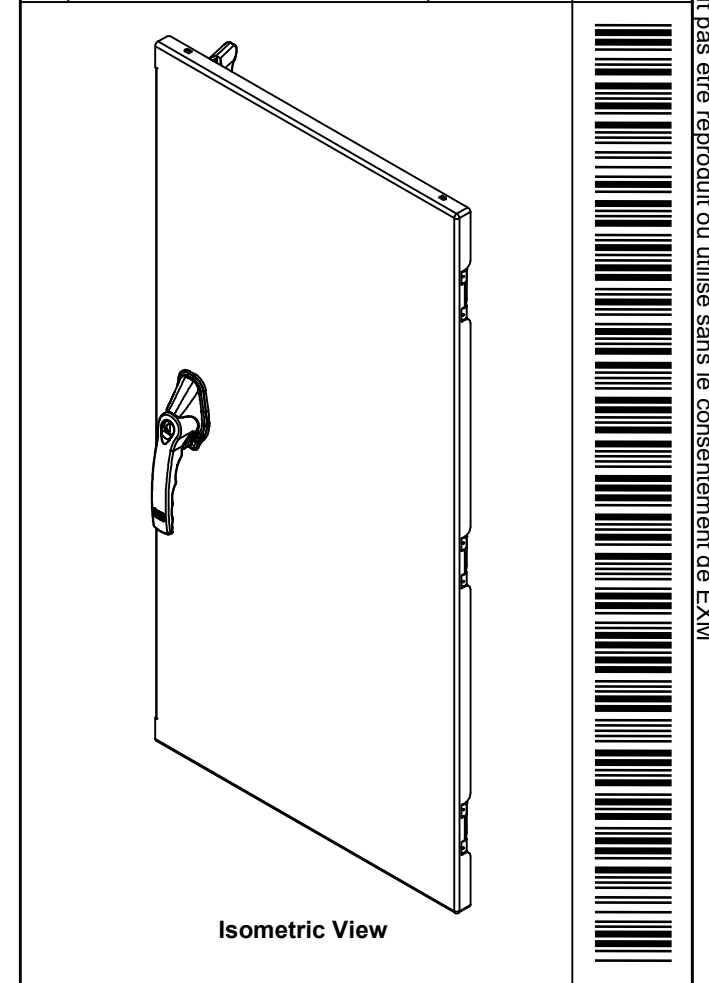

<p>Tél: (450) 979-4373 Fax: (450) 979-4626 <a href="http://www.exmweb.com">www.exmweb.com</a></p>	Flatness Aplatissement	Max 3.0mm
	Projection	
Customer Client	Date	
Drawn By Dessiné Par	BoxCad: BoxCad	Date 23-Sep-21
Material Matière	14 Ga Cold Rolled A1008 CS Type B (1.7mm)	
Color Couleur	Asa-61 Grey	Finish Fini Smooth
Description	Detail Rev.	
5300MCDD 36" x 36" Lock Door		
Part Number Numéro Pièce	Rev.	8
SEE BILL OF MATERIAL ON LAST PAGE		0
5300MCDD363610LD		15



This drawing is confidential and must not be reproduced or used without the consent of EXM

Ce dessin est confidentiel et ne doit pas être reproduit ou utilisé sans le consentement de EXM

**STANDARD FEATURES ARE NOT LISTED IN THIS HOLE TABLE**

**HOLE TABLE - FRONT VIEW (CUSTOM FEATURE ONLY)**

CUT-OUT	XDIM	YDIM	DESCRIPTION
1	15.615	30.896	CLOSING BAR STUD (Inside)
2	15.615	4.907	CLOSING BAR STUD (Inside)
-----	-----	-----	-----
3	1.486	2.000	GND STUD M6 x 16mm (Inside)
4	15.615	17.902	HANDLE 885 ESL2A-APHK @ 0.0°

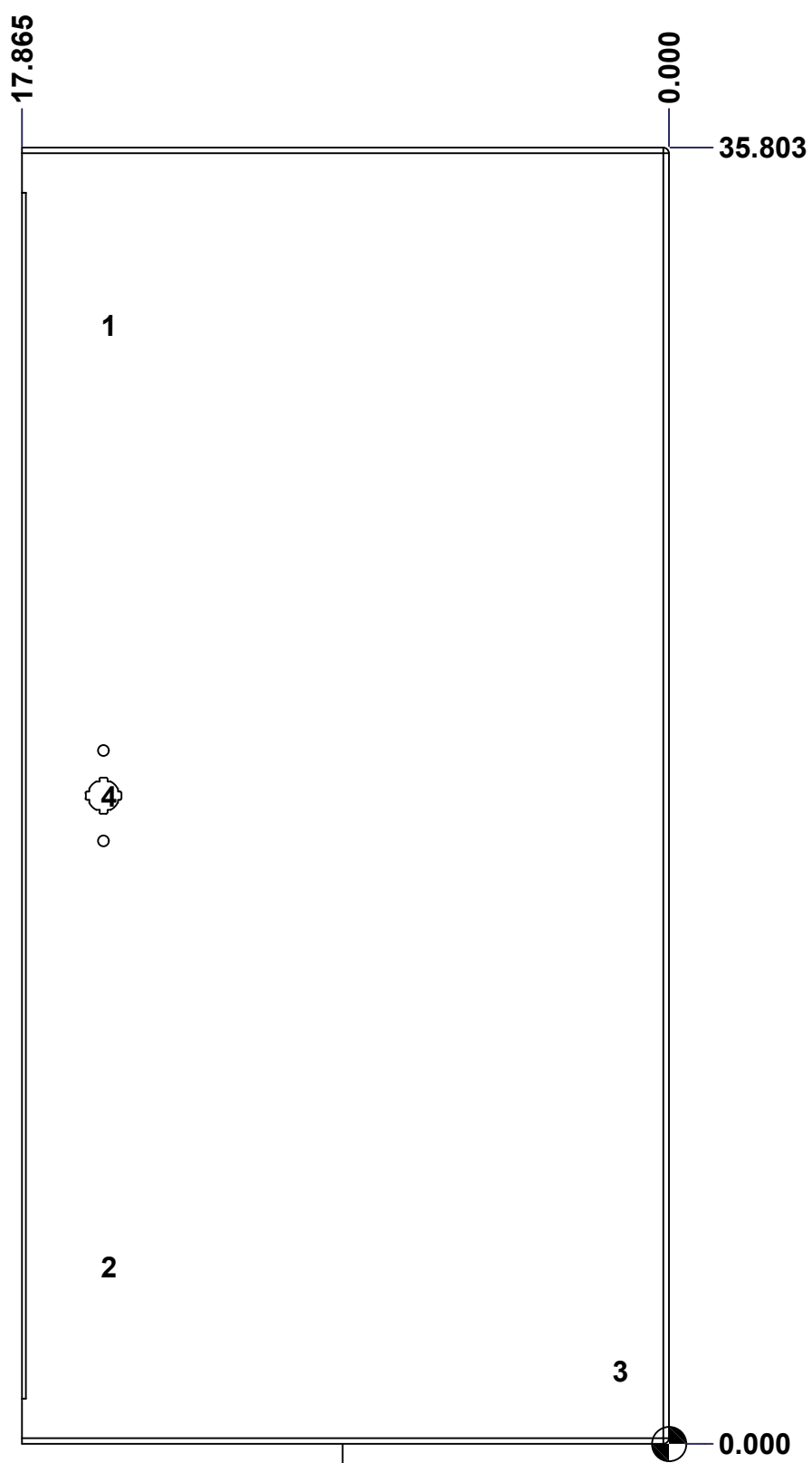

FRONT

	Description	Status
	5300MCDD 36" x 36" LD	(NULL)
	Part Number Numéro Pièce	Rev.
	<b>5300MCDD363610LD</b>	<b>0</b> / 9
		15

This drawing is confidential and must not be reproduced or used without the consent of EXM

Ce dessin est confidentiel et ne doit pas être reproduit ou utilisé sans le consentement de EXM

No.	Revisions	Date	By/Par

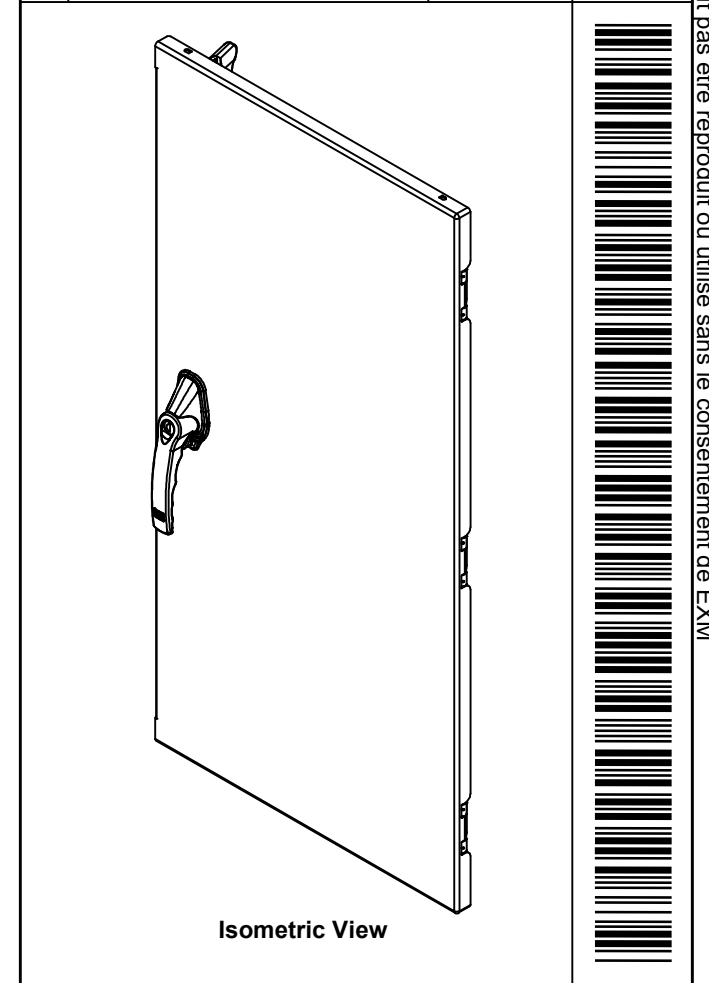

**EXM**  
exm

Tél: (450) 979-4373  
Fax: (450) 979-4626  
[www.exmweb.com](http://www.exmweb.com)

Flatness  
Aplatissement  
Max 3.0mm

Projection

2	STK-Q-90042	4	5412 ES - Cabinet Closing Bar End (Small)
2	STK-Q-45655-36	0	5412 ES - Closing Bar
1	STK-Q-50535	14	5412 ES - Handle Cam Counter Clockwise (Grip 32mm)
1	STK-Q-90051	3	5412 ES - Handle Cam Spacer
1	885ESL2A-APHK	6	885 ESL2A-APHK - Zinc Die Cast L-Handle Padlockable Assy
1	STK-Q-16080	0	Ground Stud M6 x 16mm Steel
2	STK-Q-16405	6	Guide Stud - Small (No Paint Cap Required)
1	5300MCDD363610LD-G	0	5300MCDD 36" x 36" Lock Door Gasket
1	5300MCDD363610LD-P	0	5300MCDD 36" x 36" Lock Door
3	STK-K-09800	10	5412 ES Hinge with 2 Captive Hinge Pins

Customer Client	Date
Drawn By Dessiné Par BoxCad: BoxCad	Date 23-Sep-21
Material Matière 14 Ga Cold Rolled A1008 CS Type B (1.7mm)	
Color Couleur Asa-61 Grey	Finish Fini Smooth
Description 5300MCDD 36" x 36" Lock Door	Detail Rev.
Part Number Numéro Pièce <b>5300MCDD363610LD</b>	Rev. 10

Qty	Part Name	Rev	Description
Parts List			

This drawing is confidential and must not be reproduced or used without the consent of EXM

Ce dessin est confidentiel et ne doit pas être reproduit ou utilisé sans le consentement de EXM



TOP

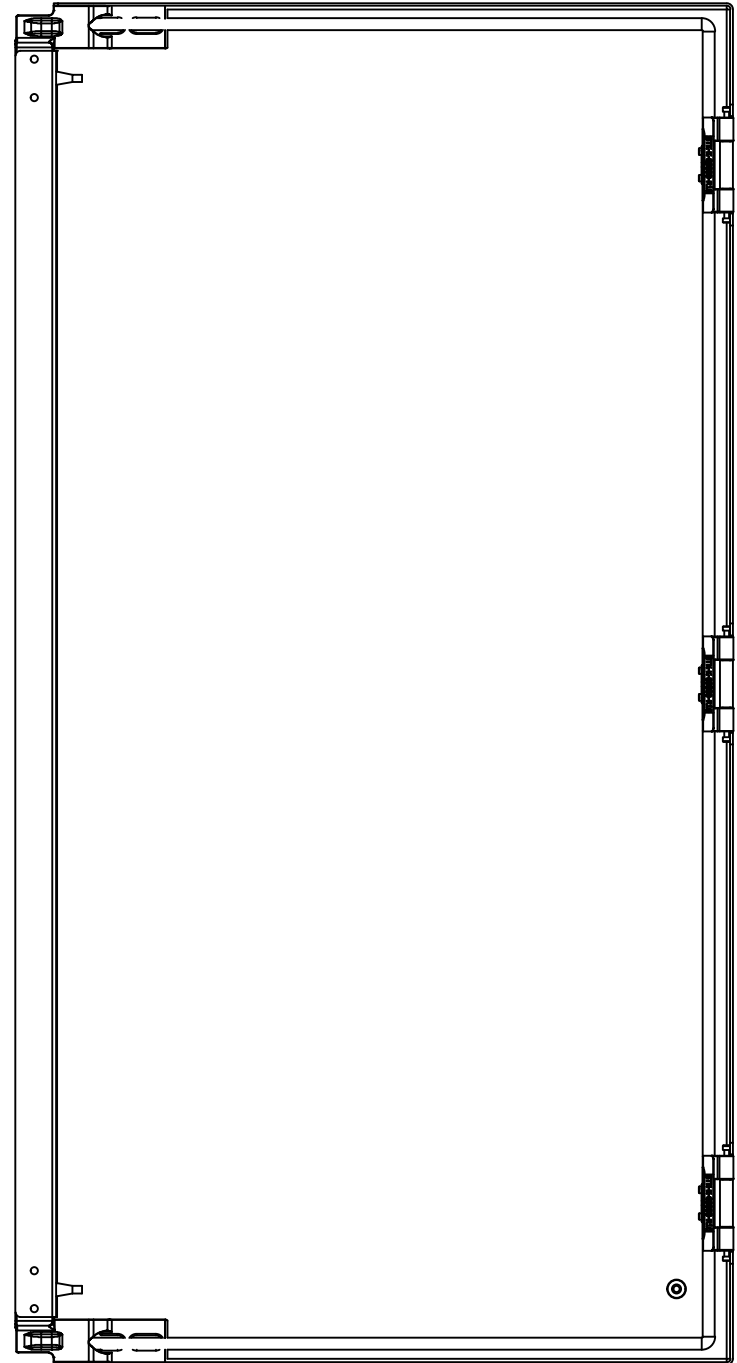

0.000  
0.800

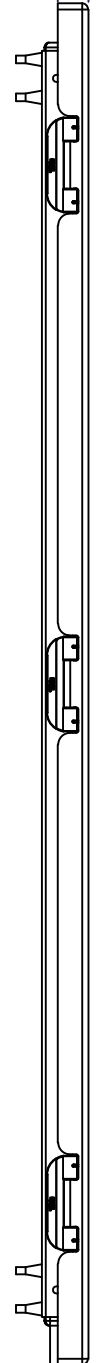

LEFT

0.000

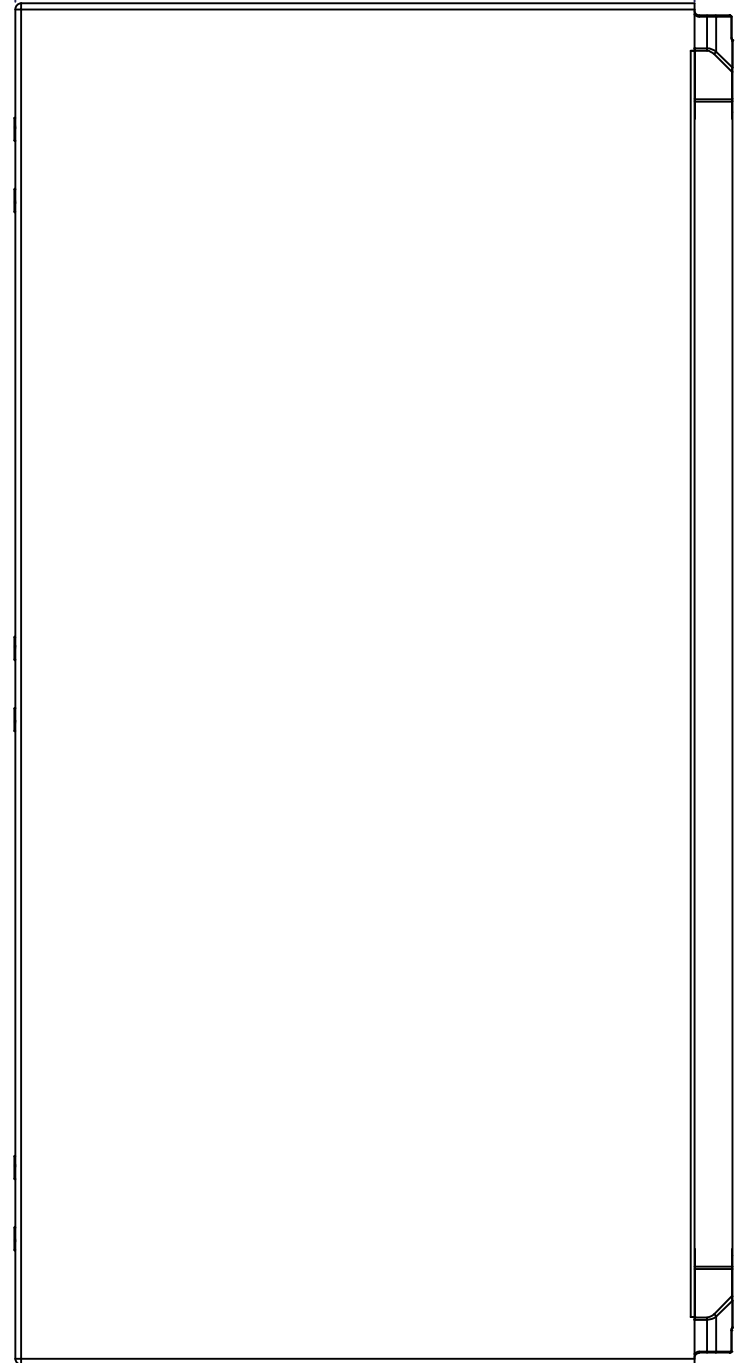

FRONT

17.865

35.803

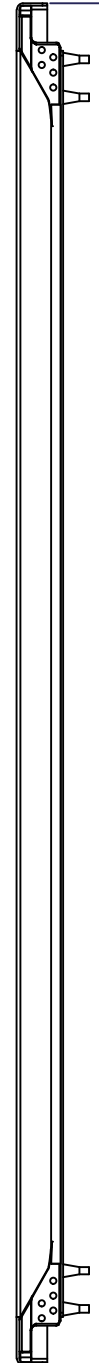

RIGHT

0.000

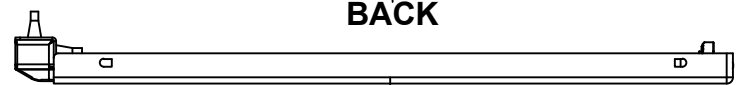

BACK



BOTTOM

No.	Revisions	Date	By/Par

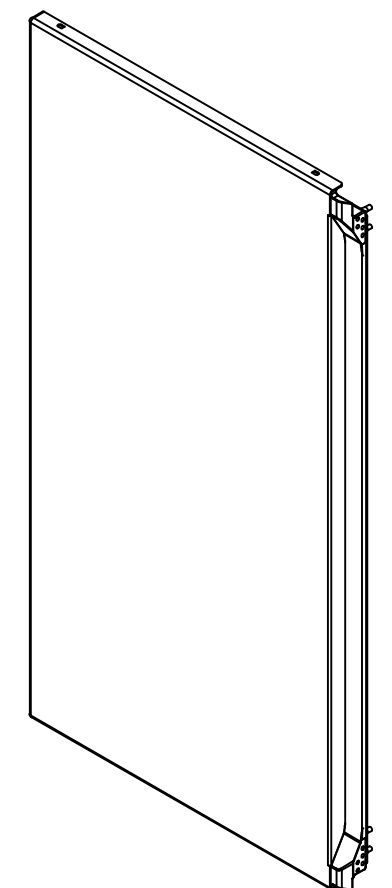

Isometric View



Tél: (450) 979-4373  
Fax: (450) 979-4626  
[www.exmweb.com](http://www.exmweb.com)

Flatness  
Aplatissement

Max 3.0mm

Projection

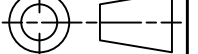

Customer Client

Date

Drawn By  
Dessiné Par

BoxCad: BoxCad

Date 23-Sep-21

Material  
Matière

14 Ga Cold Rolled A1008 CS Type B (1.7mm)

Color  
Couleur

Asa-61 Grey

Finish  
Fini

Smooth

Description  
5300MCDD 36" x 36" Flange Door

Detail Rev.

Part Number  
Numéro Pièce

**5300MCDD363610FD**

Rev. 11

**0** 15

SEE BILL OF MATERIAL ON LAST PAGE

This drawing is confidential and must not be reproduced or used without the consent of EXM

Ce dessin est confidentiel et ne doit pas être reproduit ou utilisé sans le consentement de EXM

**STANDARD FEATURES ARE NOT LISTED IN THIS HOLE TABLE**

**HOLE TABLE - FRONT VIEW (CUSTOM FEATURE ONLY)**

CUT-OUT	XDIM	YDIM	DESCRIPTION
1	1.486	2.000	GND STUD M6 x 16mm (Inside)

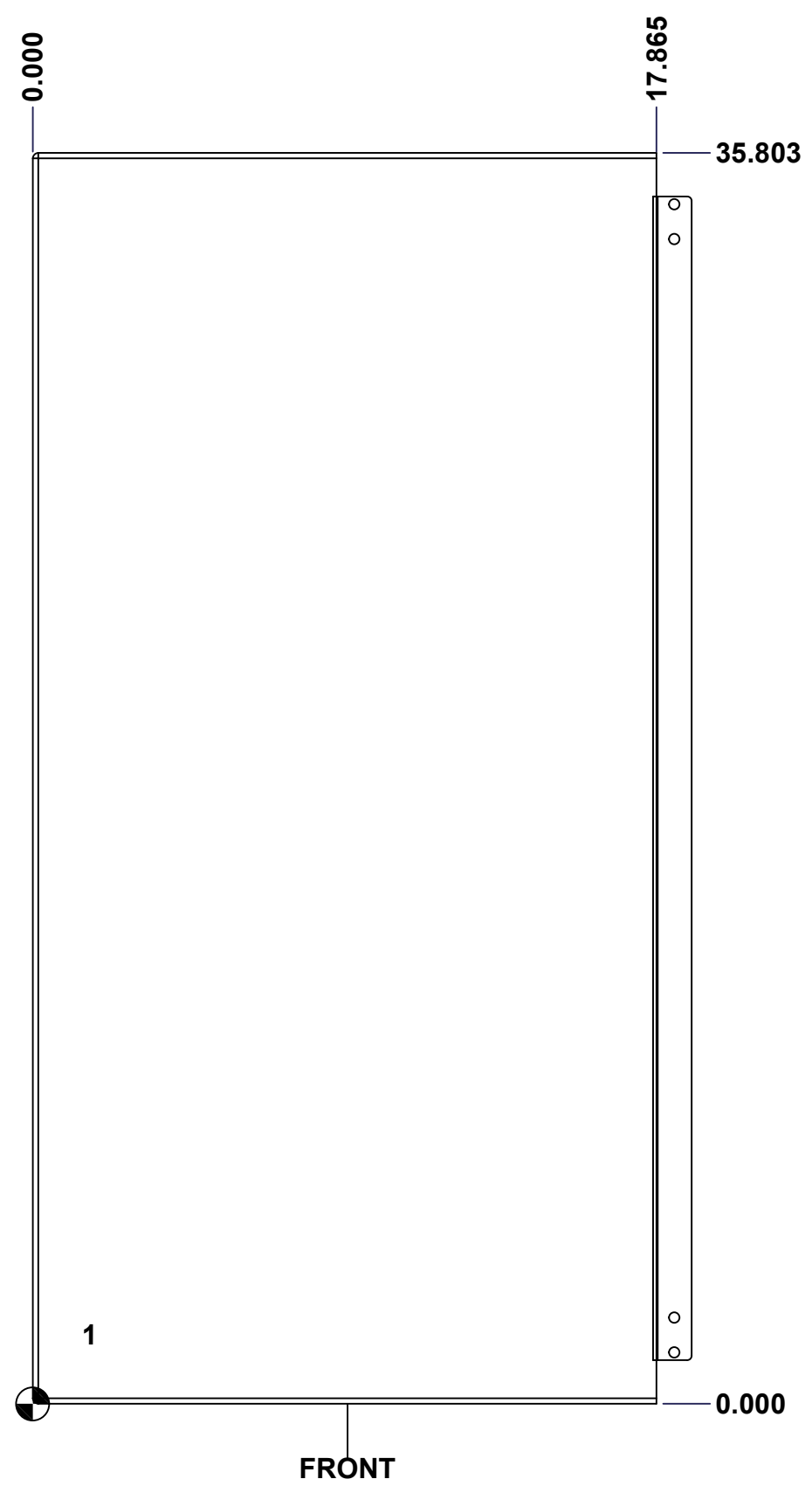

	Description	Status	
	5300MCDD 36" x 36" Flange Door	(NULL)	
	Part Number Numéro Pièce	Rev.	12
	<b>5300MCDD363610FD</b>	<b>0</b>	15

This drawing is confidential and must not be reproduced or used without the consent of EXM

Ce dessin est confidentiel et ne doit pas être reproduit ou utilisé sans le consentement de EXM

No.	Revisions	Date	By/Par

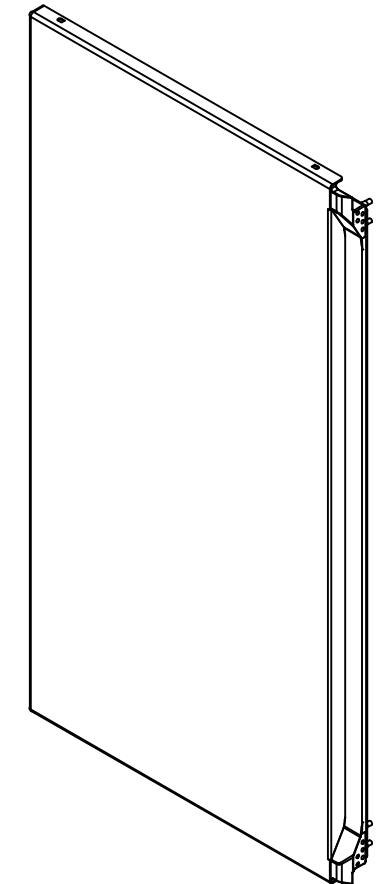

Isometric View

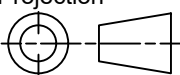

 Tél: (450) 979-4373 Fax: (450) 979-4626 <a href="http://www.exmweb.com">www.exmweb.com</a>	Flatness Aplatissement	Max 3.0mm
	Projection	
Customer Client	Date	
Drawn By Dessiné Par	BoxCad: BoxCad	Date 23-Sep-21
Material Matière	14 Ga Cold Rolled A1008 CS Type B (1.7mm)	
Color Couleur	Asa-61 Grey	Finish Fini Smooth
Description	Detail Rev.	
5300MCDD 36" x 36" Flange Door		
Part Number Numéro Pièce	Rev. 0	13 / 15
<b>5300MCDD363610FD</b>		

Qty	Part Name	Rev	Description
1	STK-Q-16080	0	Ground Stud M6 x 16mm Steel
1	STK-P-02400S	0	Powder Paint (Asa-61 Grey / Smooth)
1	STK-G-00701	0	1" x 1/4" Self-Adhesive Neoprene Gasket
1	STK-G-03200	7	5500 ESDD Lower Flange Door Gasket
1	STK-G-03100	7	5500 ESDD Upper Flange Door Gasket
1	5300MCDD363610FD-G	0	5300MCDD 36" x 36" Flange Door Gasket
1	5300MCDD363610FD-P	0	5300MCDD 36" x 36" Flange Door Part
3	STK-K-09800	10	5412 ES Hinge with 2 Captive Hinge Pins
Parts List			

This drawing is confidential and must not be reproduced or used without the consent of EXM

Ce dessin est confidentiel et ne doit pas être reproduit ou utilisé sans le consentement de EXM

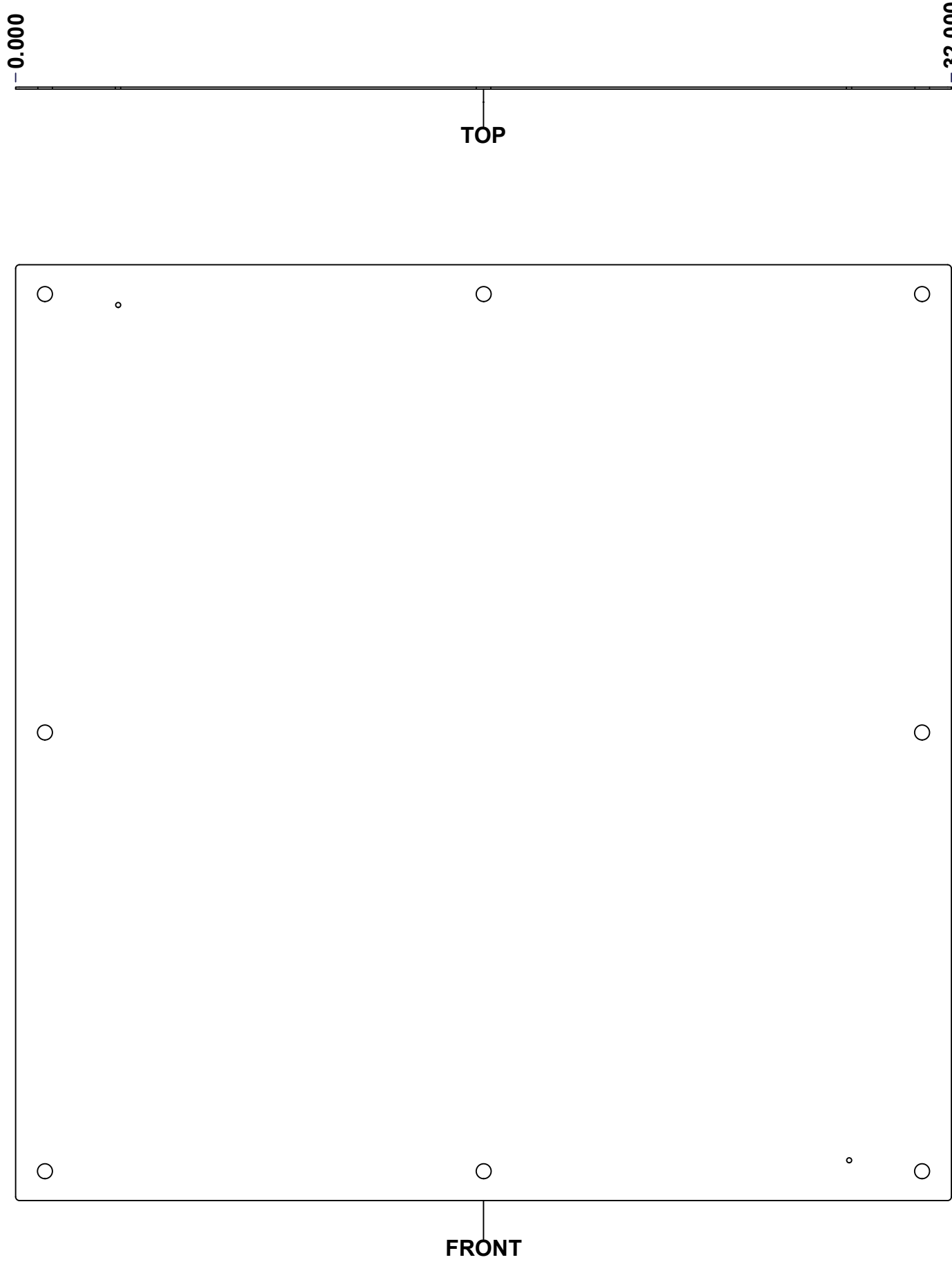

No.	Revisions	Date	By/Par

**Isometric View**

<p>Tél: (450) 979-4373                  Fax: (450) 979-4626  <a href="http://www.exmweb.com">www.exmweb.com</a></p>		Flatness Aplatissement
		Max 3.0mm
Projection		
Customer Client		Date
Drawn By Dessiné Par	BoxCad: BoxCad	Date 23-Sep-21
Material Matière	14 Ga Galvanized	
Color Couleur	Unpainted	Finish Fini Unpainted
Description		Detail Rev.
5300MCDD 36" x 36" Inner Panel Part		
Part Number Numéro Pièce	Rev.	14
<b>5300MCDD363610IP</b>	<b>0</b>	15

**SEE BILL OF MATERIAL ON LAST PAGE**

This drawing is confidential and must not be reproduced or used without the consent of EXM

Ce dessin est confidentiel et ne doit pas être reproduit ou utilisé sans le consentement de EXM

No.	Revisions	Date	By/Par

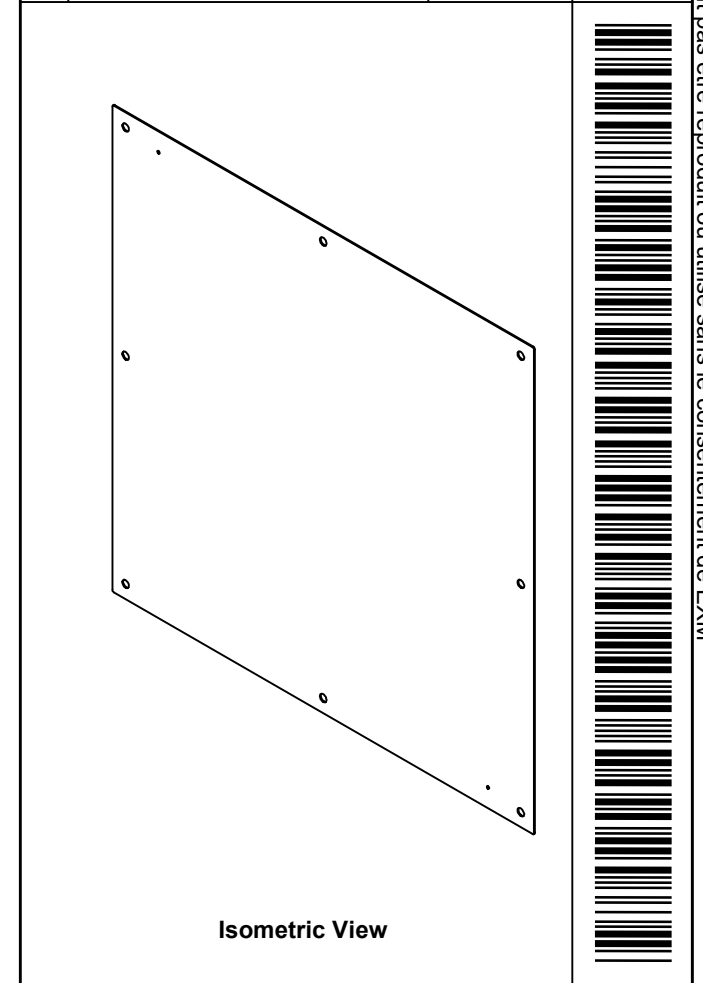

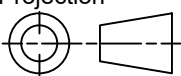
 Tél: (450) 979-4373 Fax: (450) 979-4626 <a href="http://www.exmweb.com">www.exmweb.com</a>		Flatness Aplatissement Max 3.0mm
Customer Client		Projection 
Drawn By / Dessiné Par: BoxCad: BoxCad		Date: 23-Sep-21
Material / Matière: 14 Ga Galvanized		
Color / Couleur: Unpainted	Finish / Fini: Unpainted	
Description: 5300MCDD 36" x 36" Inner Panel Part		Detail Rev.
Part Number / Numéro Pièce: <b>5300MCDD363610IP</b>		Rev. 0 / 15

Qty	Part Number	Rev	Description
1	5300MCDD363610IP-P	0	5300MCDD 36" x 36" Inner Panel Part
Parts List			