

This drawing is confidential and must not be reproduced or used without the consent of EXM

Ce dessin est confidentiel et ne doit pas être reproduit ou utilisé sans le consentement de EXM

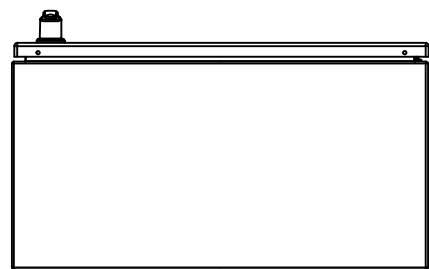

TOP

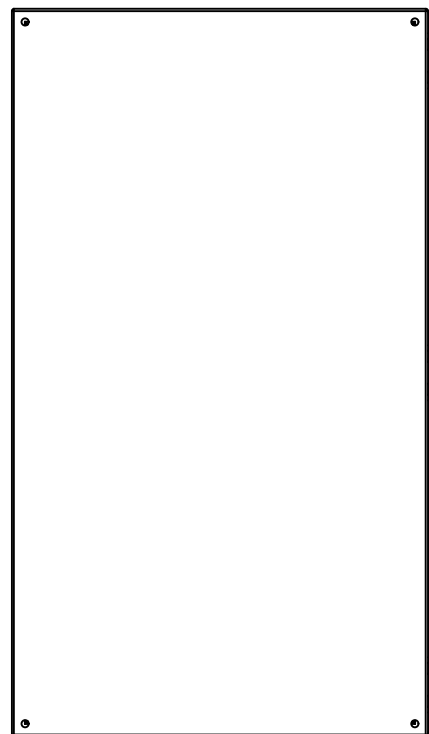

BACK

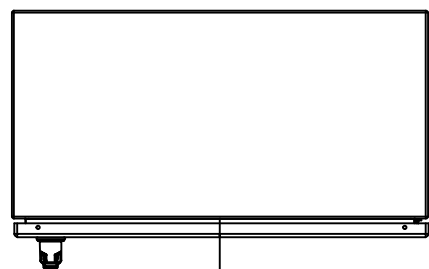

BOTTOM

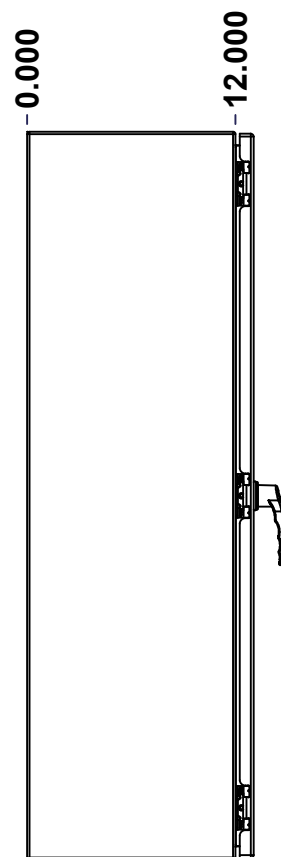

LEFT

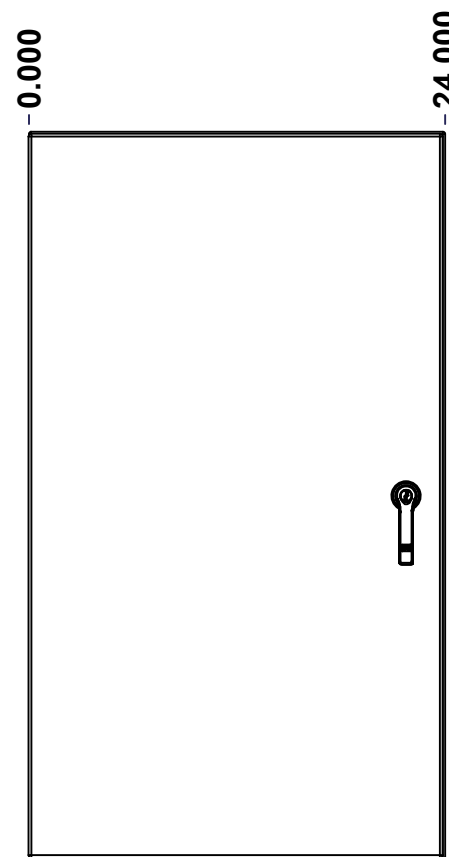

FRONT

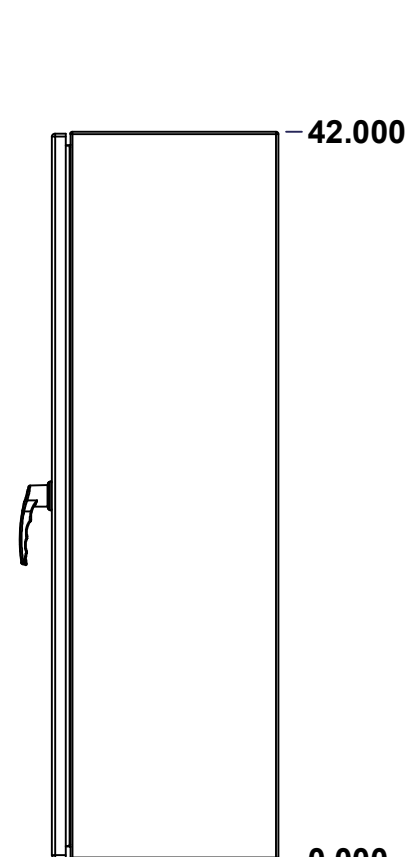

RIGHT

| No. | Revisions | Date | By/Par |
|-----|-----------|------|--------|
| | | | |
| | | | |
| | | | |
| | | | |
| | | | |

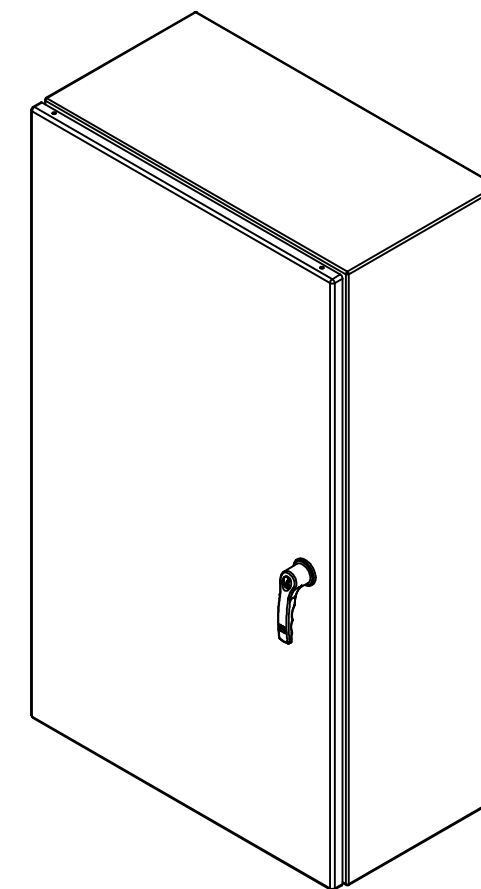

Isometric View



Tél: (450) 979-4373
 Fax: (450) 979-4626
www.exmweb.com

Flatness
Aplatissement

Max 3.0mm

Projection



| | |
|--------------------------------------------------|-----------------------|
| Customer Client | Date |
| Drawn By Dessiné Par BoxCad: BoxCad | Date 05-Sep-14 |
| Material Matière Aluminum 5052-H32 (2.3mm) | |
| Color Couleur Asa-61 Grey | Finish Fini Smooth |
| Description 5412EAL 42" x 24" x 12" Assembly | Detail Rev. |
| Part Number Numéro Pièce 5412EAL422412 | Rev. 0 |

SEE BILL OF MATERIAL ON LAST PAGE

1
9

This drawing is confidential and must not be reproduced or used without the consent of EXM

Ce dessin est confidentiel et ne doit pas être reproduit ou utilisé sans le consentement de EXM

| NOTE | |
|------|--------------------------------------------|
| ITEM | DESCRIPTION |
| 1 | NEMA 4X Enclosure |
| 2 | C/W Standard ground studs on box and cover |
| 3 | C/W Standard door stiffener |
| 4 | C/W Standard inner panel (Included) |
| 5 | C/W Standard inner panel mounting studs |
| 6 | C/W 880 PP included (Not installed) |

| No. | Revisions | Date | By/Par |
|-----|-----------|------|--------|
| | | | |
| | | | |
| | | | |
| | | | |
| | | | |
| | | | |

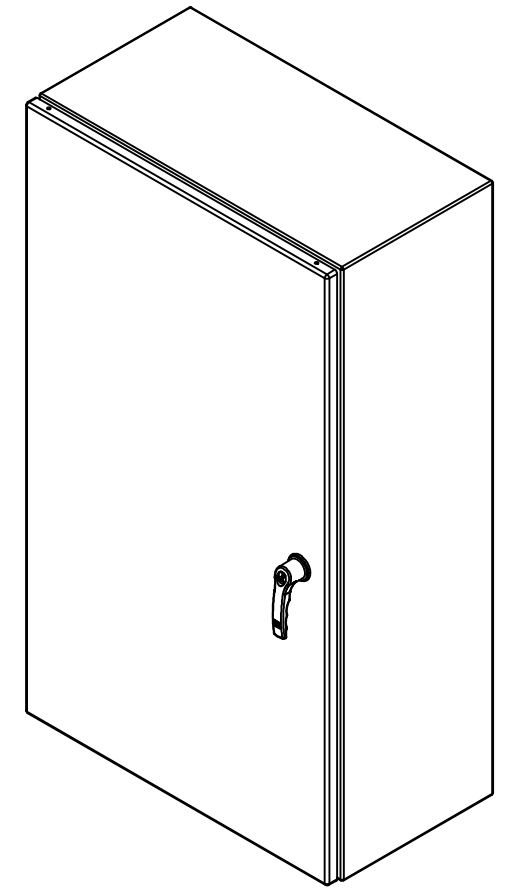

Isometric View



 Tél: (450) 979-4373
 Fax: (450) 979-4626
www.exmweb.com

Flatness
 Aplatissement
 Max 3.0mm
 Projection

| | |
|-------------------------|----------------|
| Customer Client | Date |
| Drawn By Dessiné Par | Date 05-Sep-14 |

Material Matière Aluminum 5052-H32 (2.3mm)

Color Couleur Asa-61 Grey Finish Fini Smooth

Description 5412EAL 42" x 24" x 12" Assembly Detail Rev.

Part Number Numéro Pièce **5412EAL422412** Rev. 0 2/9

| PACKING | | |
|-----------------------|-----|------------------------------------------------|
| ITEM | QTY | DESCRIPTION |
| Cardboard sleeve | 2 | Top and Bottom |
| Cardboard strip | 2 | Between back of enclosure and inner panel |
| Plastic bag | 1 | To protect cover surface and inside gasket |
| Cardboard corner | 4 | To reinforced for the plastic strap tightening |
| Plastic strap - Black | 2 | To Squeeze the 2 cardboard sleeve together |
| Packaging label | 3 | White label with PN |
| Plastic strap- Green | 2 | To secure the enclosure to the wood pallet |
| Wood Pallet | 1 | 2" deeper and 3" larger than enclosure size |

| Qty | Part Number | Rev | Description |
|------------|----------------|-----|--------------------------------------------|
| 2 | STK-Q-07310 | 2 | Flange Lock Nut M8 |
| 1 | 881 SP4224G | 0 | 881 SP - Inner Panel |
| 2 | STK-Q-07615 | 0 | Inner Panel Support Bracket |
| 2 | STK-K-01320 | 0 | 5412 ES Inner Panel Accessory Kit |
| 1 | 880 PP | 6 | Self Adhesive Print Pocket |
| 1 | STK-K-01800 | 5 | 5412 ES Accessory Kit |
| 1 | 5412EAL422412C | 0 | 5412EAL 42" x 24" Cover |
| 1 | 5412EAL422412B | 0 | 5412EAL 42" x 24" x 12" Body |
| 3 | STK-Q-04050-08 | 0 | M6 x 8mm Hexagon Socket Head Machine Screw |
| Parts List | | | |

This drawing is confidential and must not be reproduced or used without the consent of EXM

Ce dessin est confidentiel et ne doit pas être reproduit ou utilisé sans le consentement de EXM

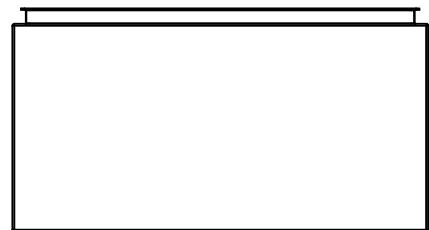

TOP

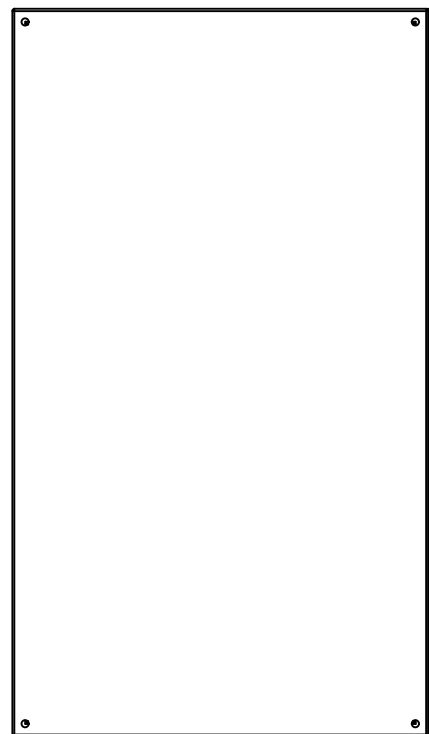

BACK



BOTTOM

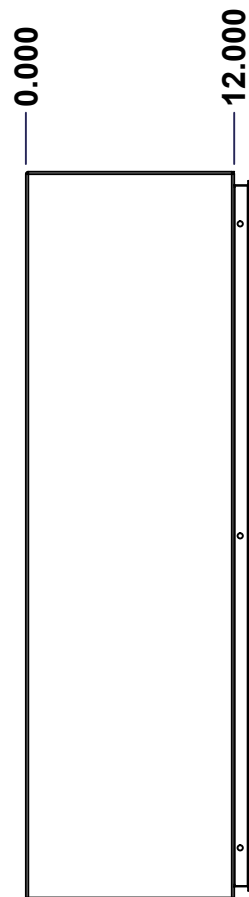

LEFT

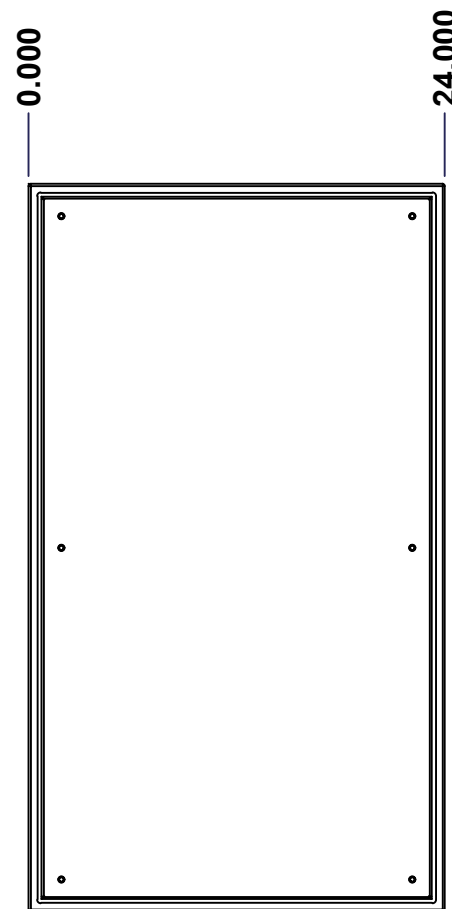

FRONT

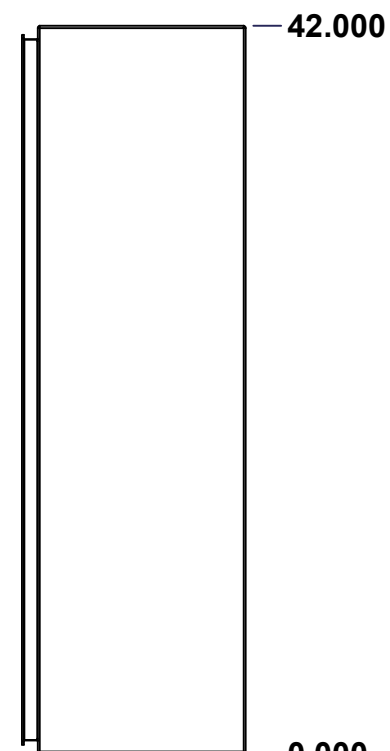

RIGHT

| No. | Revisions | Date | By/Par |
|-----|-----------|------|--------|
| | | | |
| | | | |
| | | | |
| | | | |

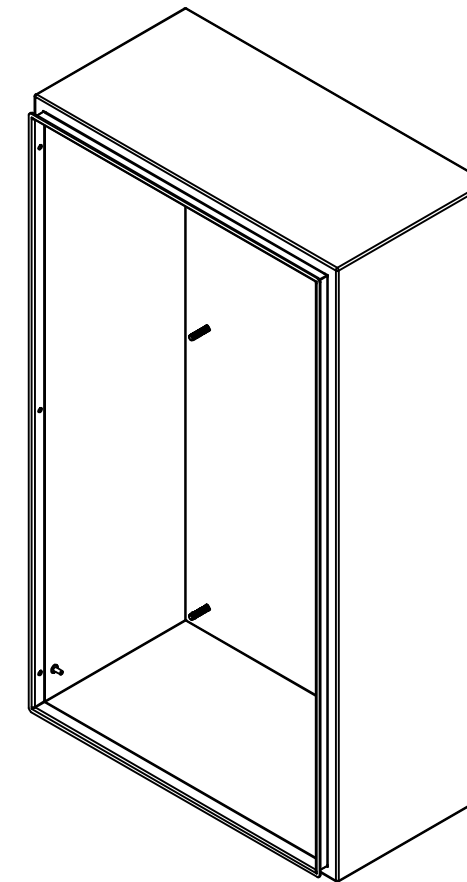

Isometric View



Tél: (450) 979-4373
 Fax: (450) 979-4626
www.exmweb.com

Flatness
Aplatissement

Max 3.0mm

Projection



| | |
|-----------------------------------------------|-----------------------|
| Customer Client | Date |
| Drawn By Dessiné Par BoxCad: BoxCad | Date 05-Sep-14 |
| Material Matière Aluminum 5052-H32 (2.3mm) | |
| Color Couleur Asa-61 Grey | Finish Fini Smooth |
| Description 5412EAL 42" x 24" x 12" Body | Detail Rev. |
| Part Number Numéro Pièce 5412EAL422412B | Rev. 3 |
| SEE BILL OF MATERIAL ON LAST PAGE | 0 |

This drawing is confidential and must not be reproduced or used without the consent of EXM

Ce dessin est confidentiel et ne doit pas être reproduit ou utilisé sans le consentement de EXM

STANDARD FEATURES ARE NOT LISTED IN THIS HOLE TABLE

HOLE TABLE - LEFT VIEW (CUSTOM FEATURE ONLY)

| CUT-OUT | XDIM | YDIM | DESCRIPTION |
|---------|--------|-------|-----------------------------|
| 1 | 10.500 | 2.000 | GND STUD M6 x 16mm (Inside) |

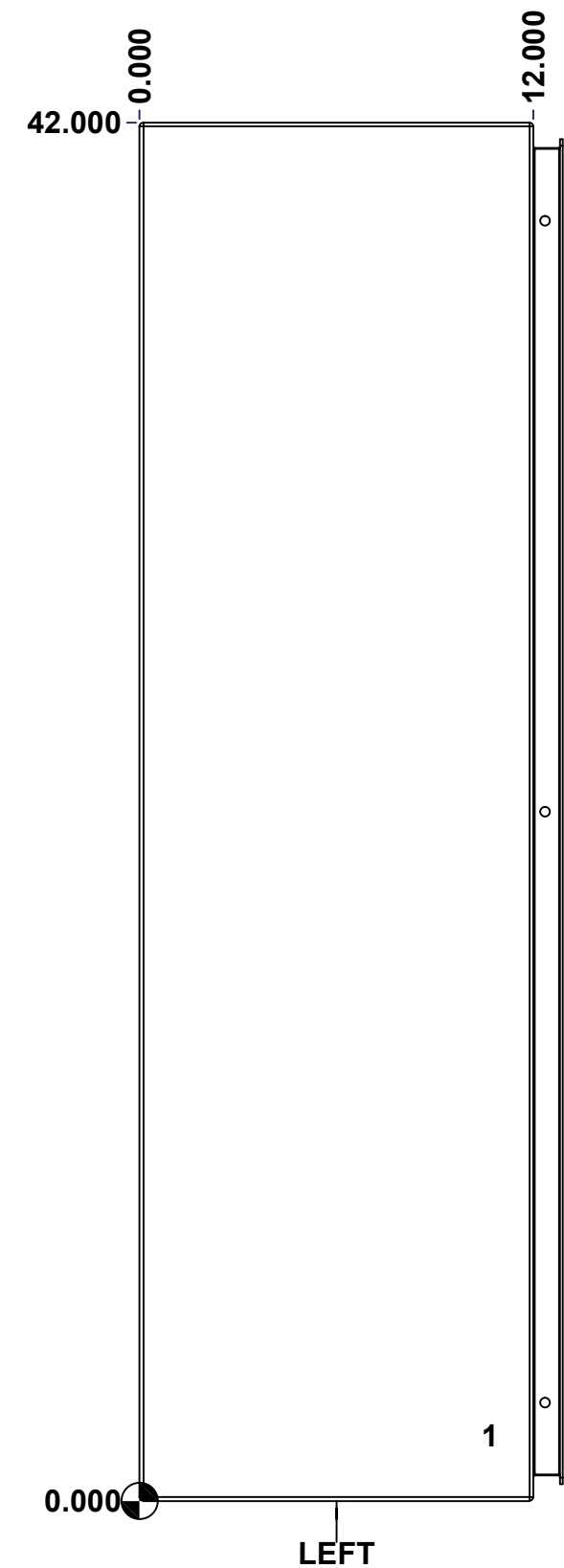

| | | | |
|--|------------------------------|----------|--------|
| | Description | Status | |
| | 5412EAL 42" x 24" x 12" Body | (NULL) | |
| | Part Number Numéro Pièce | Rev. | |
| | 5412EAL422412B | 0 | 4 9 |

This drawing is confidential and must not be reproduced or used without the consent of EXM

Ce dessin est confidentiel et ne doit pas être reproduit ou utilisé sans le consentement de EXM

STANDARD FEATURES ARE NOT LISTED IN THIS HOLE TABLE

HOLE TABLE - BACK VIEW (CUSTOM FEATURE ONLY)

| CUT-OUT | XDIM | YDIM | DESCRIPTION |
|---------|--------|--------|----------------------------|
| 1 | 1.875 | 1.875 | IP STUD M8 x 35mm (Inside) |
| 2 | 1.875 | 40.125 | IP STUD M8 x 35mm (Inside) |
| 3 | 22.125 | 40.125 | IP STUD M8 x 35mm (Inside) |
| 4 | 22.125 | 1.875 | IP STUD M8 x 35mm (Inside) |
| 5 | 1.875 | 21.000 | IP STUD M8 x 35mm (Inside) |
| 6 | 22.125 | 21.000 | IP STUD M8 x 35mm (Inside) |
| ----- | | | |
| 7 | 23.250 | 0.750 | RND Ø0.390 |
| 8 | 23.250 | 41.250 | RND Ø0.390 |
| 9 | 0.750 | 41.250 | RND Ø0.390 |
| 10 | 0.750 | 0.750 | RND Ø0.390 |

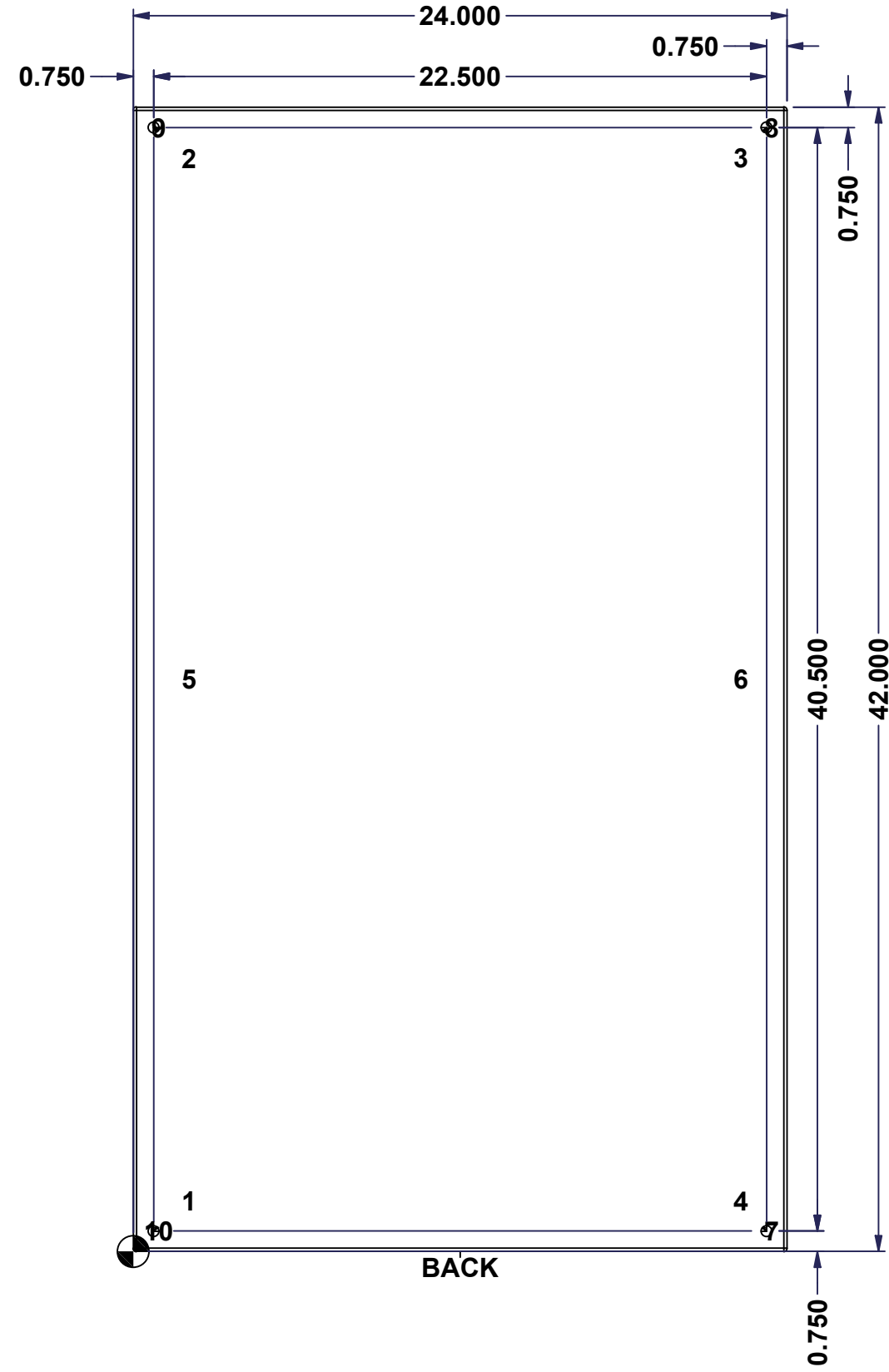

| | | |
|--|------------------------------|------------------|
| | Description | Status |
| | 5412EAL 42" x 24" x 12" Body | (NULL) |
| | Part Number Numéro Pièce | Rev. |
| | 5412EAL422412B | 0 / 5 / 9 |

This drawing is confidential and must not be reproduced or used without the consent of EXM

Ce dessin est confidentiel et ne doit pas être reproduit ou utilisé sans le consentement de EXM

| No. | Revisions | Date | By/Par |
|-----|-----------|------|--------|
| | | | |
| | | | |
| | | | |
| | | | |
| | | | |

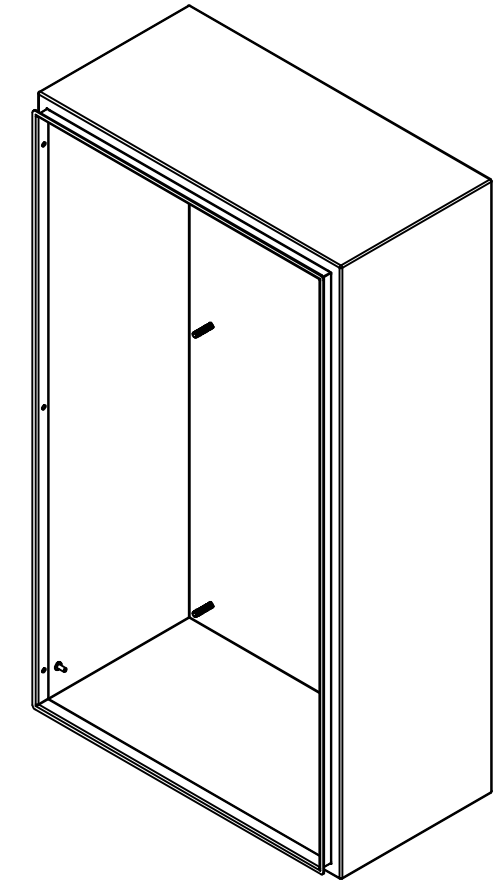

Isometric View



| | | |
|----------------------------------------------------------------------------------------------------------------------------------------------------------------------------------------|-----------------------|----------------------------------------|
|  Tél: (450) 979-4373 Fax: (450) 979-4626 www.exmweb.com | | Flatness Aplatissement Max 3.0mm |
| Customer Client | | Date |
| Drawn By / Dessiné Par: BoxCad: BoxCad | | Date: 05-Sep-14 |
| Material / Matière: Aluminum 5052-H32 (2.3mm) | | |
| Color / Couleur: Asa-61 Grey | Finish / Fini: Smooth | |
| Description: 5412EAL 42" x 24" x 12" Body | | Detail Rev. |
| Part Number / Numéro Pièce: 5412EAL422412B | | Rev. 6 0 / 9 |

| Qty | Part Number | Rev | Description |
|------------|------------------|-----|-------------------------------------|
| 1 | STK-Q-16090 | 0 | Ground Stud M6 x 16mm Aluminum |
| 1 | STK-P-02400S | 0 | Powder Paint (Asa-61 Grey / Smooth) |
| 6 | STK-Q-16010 | 0 | Stud M8 x 35mm Aluminum |
| 1 | 5412EAL422412B-P | 0 | 5412EAL 42" x 24" x 12" Body Part |
| Parts List | | | |

This drawing is confidential and must not be reproduced or used without the consent of EXM

Ce dessin est confidentiel et ne doit pas être reproduit ou utilisé sans le consentement de EXM

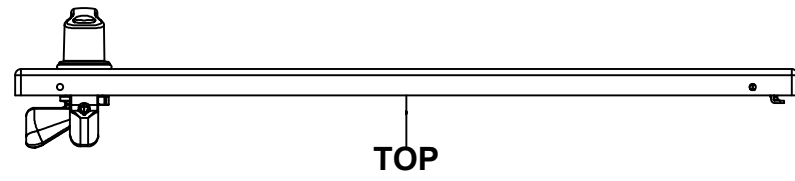

TOP

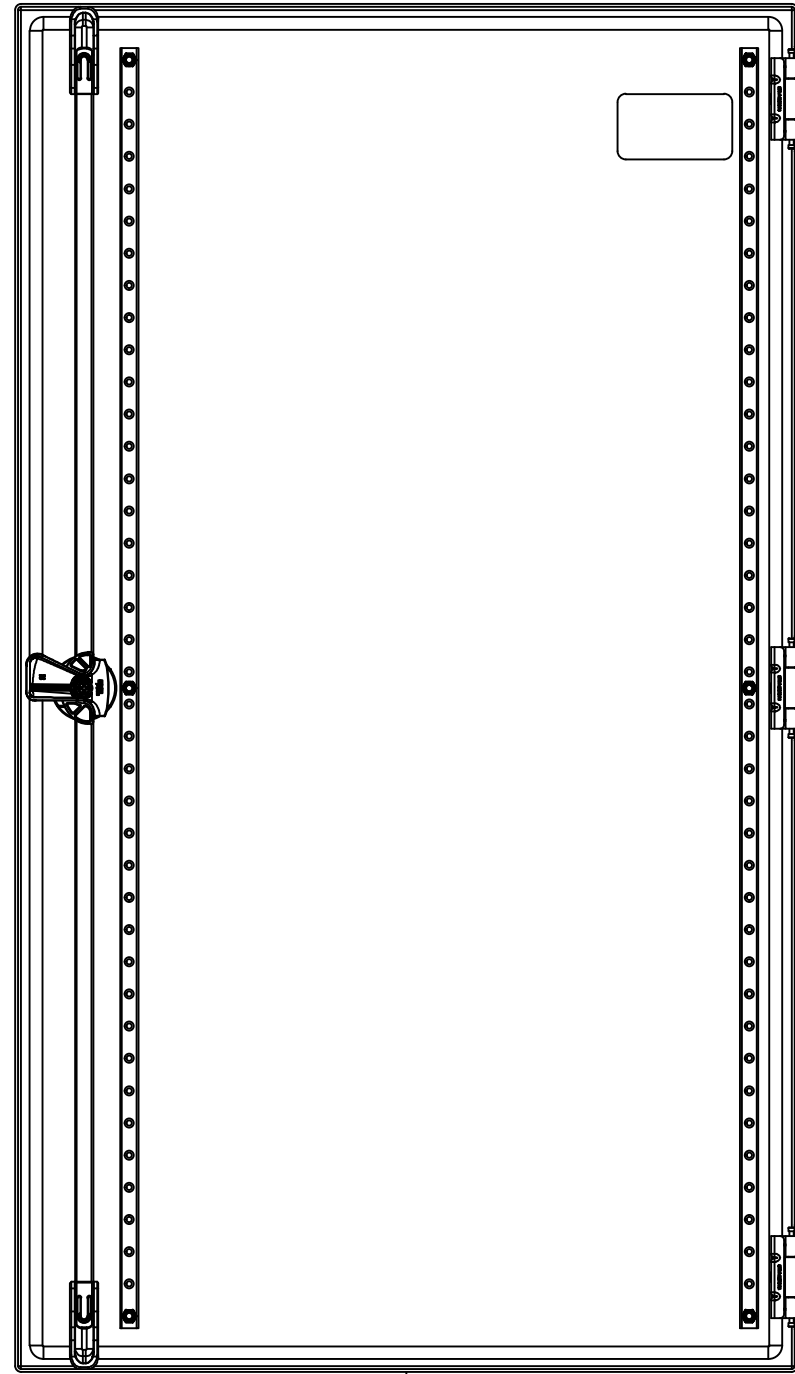

BACK

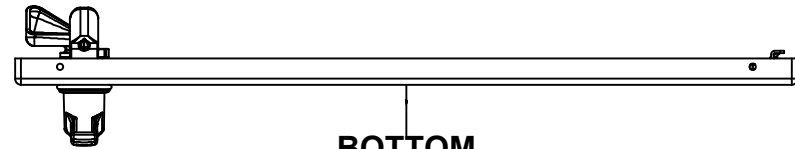

BOTTOM

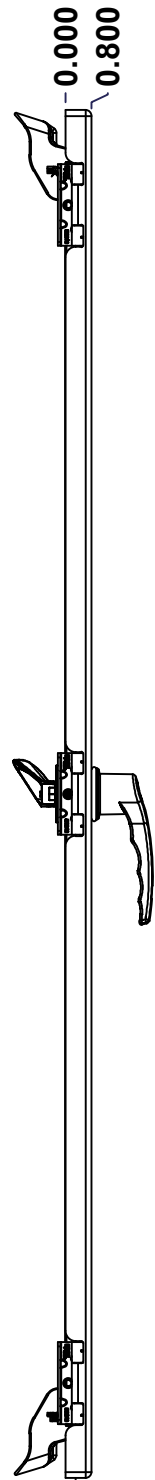

LEFT

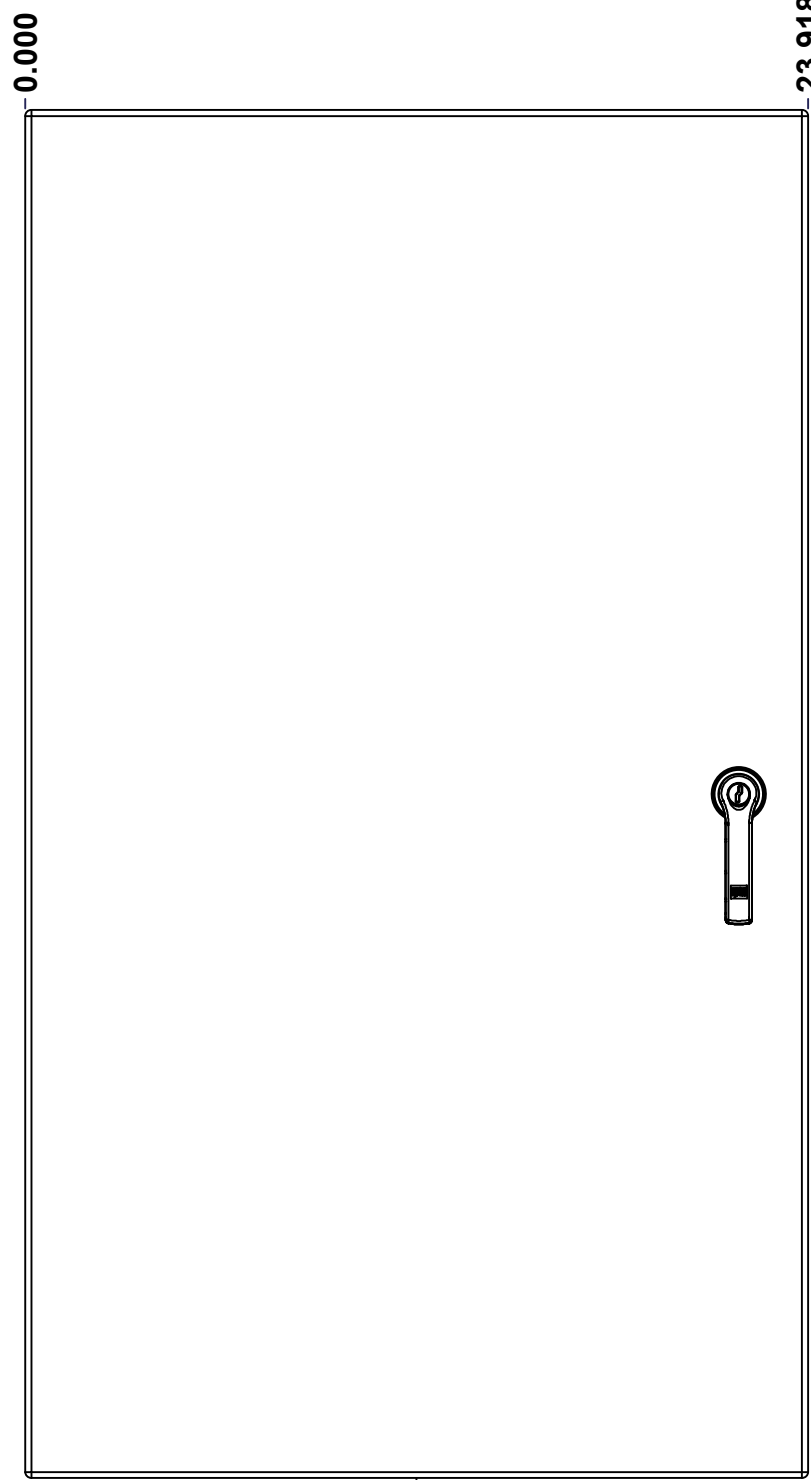

FRONT

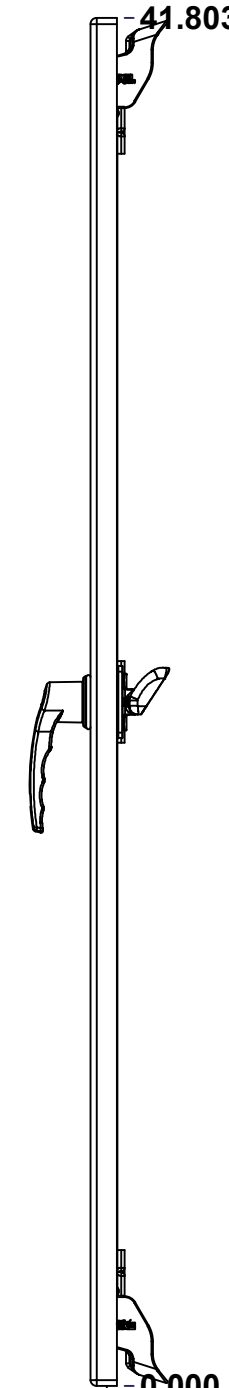

RIGHT

0.000
0.800

0.000

23.918

41.803

0.000

| No. | Revisions | Date | By/Par |
|-----|-----------|------|--------|
| | | | |
| | | | |
| | | | |
| | | | |
| | | | |

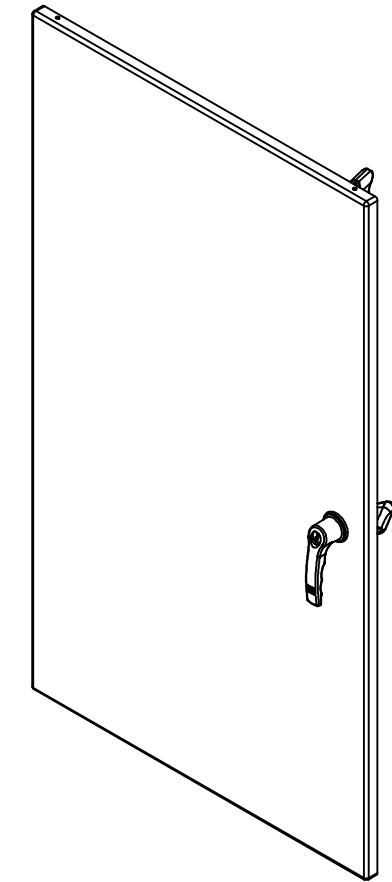

Isometric View

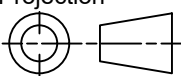

| | | |
|----------------------------------------------------------------------------------------------------------------------------------------------------------------------------------------|---------------------------|-----------------------------------------------------------------------------------------------------------------------------------------------|
|  Tél: (450) 979-4373 Fax: (450) 979-4626 www.exmweb.com | | Flatness Aplatissement Max 3.0mm Projection  |
| Customer Client | Date | |
| Drawn By Dessiné Par | BoxCad: BoxCad | Date 05-Sep-14 |
| Material Matière | Aluminum 5052-H32 (2.3mm) | |
| Color Couleur | Asa-61 Grey | Finish Fini Smooth |
| Description | Detail Rev. | |
| 5412EAL 42" x 24" Cover | | |
| Part Number Numéro Pièce | Rev. | 7 |
| 5412EAL422412C | 0 | 9 |

SEE BILL OF MATERIAL ON LAST PAGE

This drawing is confidential and must not be reproduced or used without the consent of EXM

Ce dessin est confidentiel et ne doit pas être reproduit ou utilisé sans le consentement de EXM

| STANDARD FEATURES ARE NOT LISTED IN THIS HOLE TABLE | | | |
|-----------------------------------------------------|--------|--------|---------------------------|
| HOLE TABLE - FRONT VIEW (CUSTOM FEATURE ONLY) | | | |
| CUT-OUT | XDIM | YDIM | DESCRIPTION |
| 1 | 1.486 | 1.709 | STUD M6 x 18mm (Inside) |
| 2 | 1.486 | 40.094 | STUD M6 x 18mm (Inside) |
| 3 | 20.423 | 40.094 | STUD M6 x 18mm (Inside) |
| 4 | 20.423 | 1.709 | STUD M6 x 18mm (Inside) |
| 5 | 1.486 | 20.902 | STUD M6 x 18mm (Inside) |
| 6 | 20.423 | 20.902 | STUD M6 x 18mm (Inside) |
| 7 | 21.803 | 36.896 | CLOSING BAR STUD (Inside) |
| 8 | 21.803 | 4.907 | CLOSING BAR STUD (Inside) |
| ----- | ----- | ----- | ----- |
| 9 | 3.750 | 38.053 | LABEL_EXM (Inside) |
| 10 | 21.803 | 20.902 | 885 ESL2A |

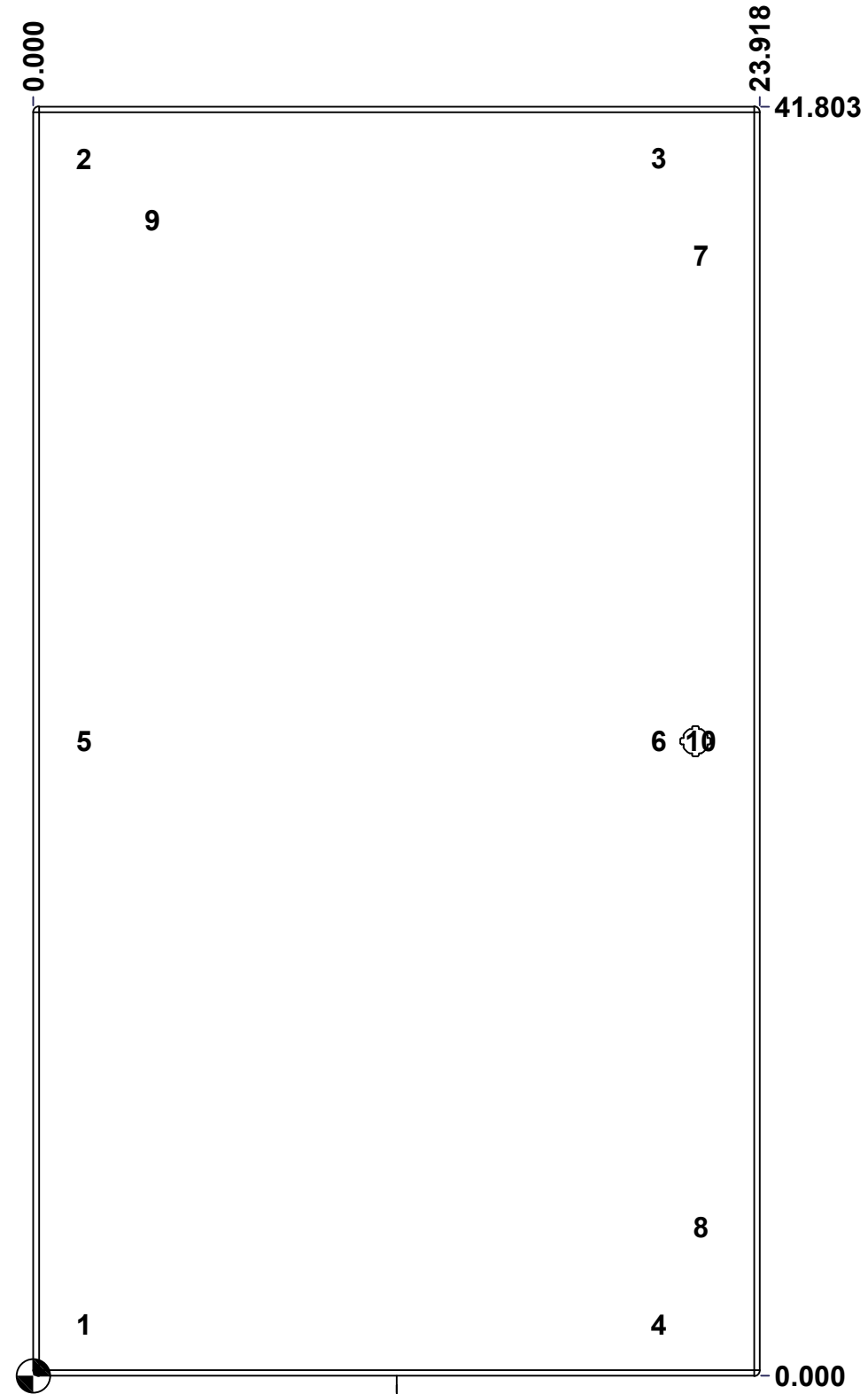

FRONT

| | | |
|--|-----------------------------|------------------|
| | Description | Status |
| | 5412EAL 42" x 24" Cover | (NULL) |
| | Part Number Numéro Pièce | Rev. |
| | 5412EAL422412C | 0 / 8 / 9 |

This drawing is confidential and must not be reproduced or used without the consent of EXM

Ce dessin est confidentiel et ne doit pas être reproduit ou utilisé sans le consentement de EXM

| No. | Revisions | Date | By/Par |
|-----|-----------|------|--------|
| | | | |
| | | | |
| | | | |
| | | | |
| | | | |

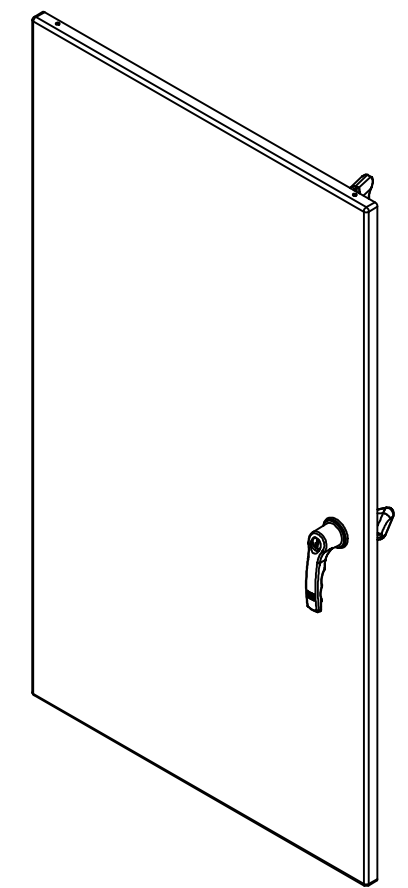

Isometric View

| | | | |
|---|------------------|----|--------------------------------------------|
| 2 | STK-Q-90042 | 4 | 5412 ES - Cabinet Closing Bar End (Small) |
| 2 | STK-Q-45655-42 | 0 | 5412 ES - Closing Bar |
| 1 | STK-Q-50536 | 13 | 5412 ES - Handle Cam Clockwise (Grip 32mm) |
| 1 | STK-Q-90051 | 2 | 5412 ES - Handle Cam Spacer |
| 1 | 885 ESL2A | 4 | 5412 ES Key Lock L-Handle (3 Pts) |
| 1 | STK-S-00100 | 0 | 3.5" x 2" Silver Milar Flexcon Sticker |
| 1 | STK-P-02400S | 0 | Powder Paint (Asa-61 Grey / Smooth) |
| 2 | STK-Q-46020-42 | 5 | 5412 ES Vertical Door Stiffener 42" |
| 2 | STK-Q-16406 | 2 | Guide Stud - Small (No Paint Cap Required) |
| 6 | STK-Q-16060 | 0 | Stud M6 x 18mm Aluminum |
| 1 | 5412EAL422412G | 0 | 5412EAL 42" x 24" Cover Gasket Part |
| 1 | 5412EAL422412C-P | 0 | 5412EAL 42" x 24" Cover Part |
| 3 | STK-A-33016 | 0 | 5412 ESS Bended Hinge (Body Part) |
| 6 | STK-Q-07220 | 1 | M6 Nylon Insert Lock Nut |

| Qty | Part Name | Rev | Description |
|------------|-----------|-----|-------------|
| Parts List | | | |

| | | |
|------------------------------------------------------|--------------------------------------------------------------------------------------------------|--------------------------------------------------|
| | Tél: (450) 979-4373 Fax: (450) 979-4626 www.exmweb.com | Flatness Aplatissement Max 3.0mm |
| | Projection | Customer Client |
| Drawn By Dessiné Par BoxCad: BoxCad | Date 05-Sep-14 | Material Matière Aluminum 5052-H32 (2.3mm) |
| Color Couleur Asa-61 Grey | Finish Fini Smooth | Description 5412EAL 42" x 24" Cover |
| Part Number Numéro Pièce 5412EAL422412C | Rev. 0 | Detail Rev. 9 |

This drawing is confidential and must not be reproduced or used without the consent of EXM

Ce dessin est confidentiel et ne doit pas être reproduit ou utilisé sans le consentement de EXM

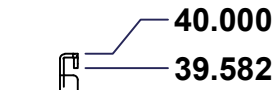
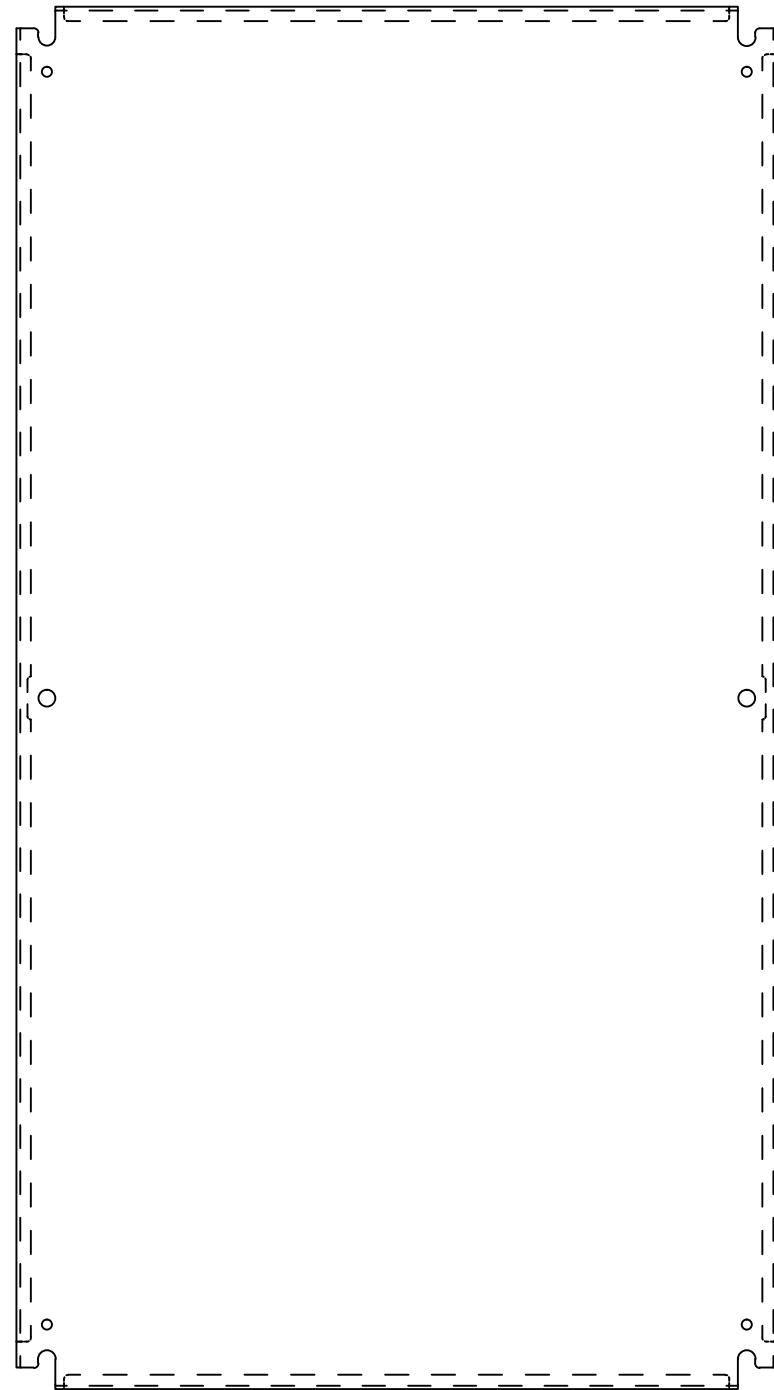
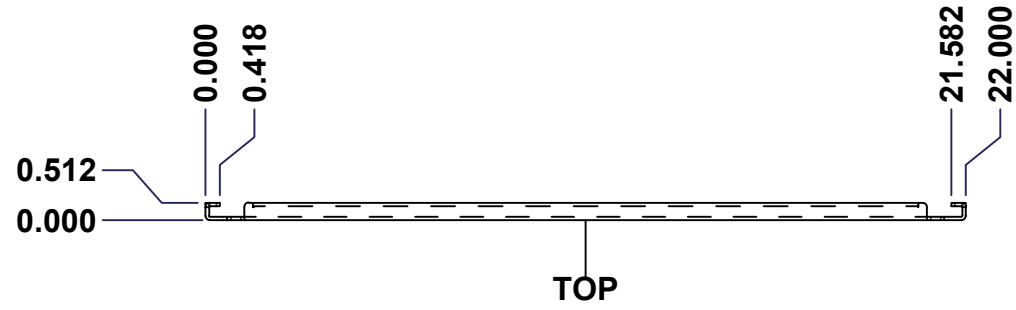

| No. | Revisions | Date | By/Par |
|-----|-----------|------|--------|
| | | | |
| | | | |
| | | | |
| | | | |
| | | | |

Isometric View

| | | |
|--------------------------------------------------------------|-----------------|----------------------------------------------------------|
| Tél: (450) 979-4373 Fax: (450) 979-4626 www.exmweb.com | | Flatness Aplatissement Max 3.0mm Projection |
| Customer Client | Date | |
| Drawn By Dessiné Par: BoxCad | Date: 23-Jan-07 | |
| Material Matière | See Part List | |
| Color Couleur | See Part List | Finish Fini: See Part List |
| Description: 881 SP - Inner Panel | | Detail Rev. |
| Part Number Numéro Pièce: 881 SP4224G | Rev. 0 | 1 2 |

| Qty | Part Number | Rev | Description | Material | Color | Finish |
|-----|---------------|-----|---------------------------|------------------|-----------|------------|
| 1 | 881 SP4224G-P | 0 | 881 SP - Inner Panel Part | 12 Ga Galvanized | Unpainted | Galvanized |

Parts List

This drawing is confidential and must not be reproduced or used without the consent of EXM

Ce dessin est confidentiel et ne doit pas être reproduit ou utilisé sans le consentement de EXM

| Table 1 | | | FRONT VIEW |
|---------|--------|--------|----------------------------|
| CUT-OUT | XDIM | YDIM | DESCRIPTION |
| 1 | 0.875 | 1.875 | GROUND HOLE (RND Ø0.290) |
| 2 | 21.125 | 1.875 | GROUND HOLE (RND Ø0.290) |
| 3 | 0.875 | 38.125 | GROUND HOLE (RND Ø0.290) |
| 4 | 21.125 | 38.125 | GROUND HOLE (RND Ø0.290) |
| 5 | 0.875 | 20.000 | MTG STUD HOLE (RND Ø0.500) |
| 6 | 21.125 | 20.000 | MTG STUD HOLE (RND Ø0.500) |

All knockouts are actual size / Les disques défonçables sont grandeur réel

| No. | Revisions | Date | By/Par |
|-----|-----------|------|--------|
| | | | |
| | | | |
| | | | |
| | | | |
| | | | |
| | | | |

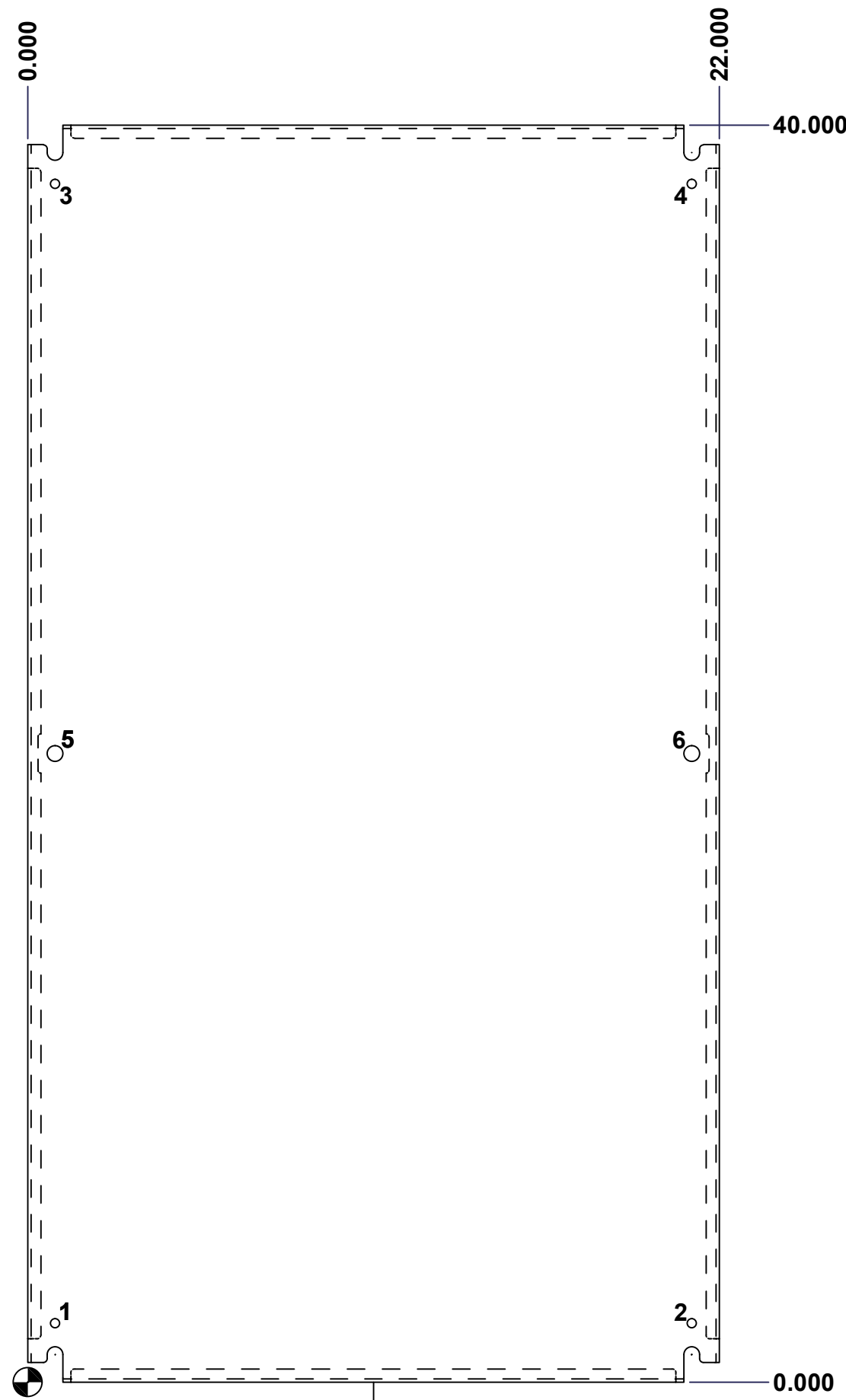

FRONT

Isometric View

| | | | | | |
|---------------------------------------------------|--|--------------------------------------------------------------|--|----------------------------------------|--|
| | | Tél: (450) 979-4373 Fax: (450) 979-4626 www.exmweb.com | | Flatness Aplatissement Max 3.0mm | |
| Customer Client | | Date | | Projection | |
| Drawn By Dessiné Par BoxCad | | Date 23-Jan-07 | | Material Matière See Part List | |
| Color Couleur See Part List | | Finish Fini See Part List | | Description 881 SP - Inner Panel | |
| Part Number Numéro Pièce 881 SP4224G | | Rev. 0 | | Detail Rev. 2 | |