

This drawing is confidential and must not be reproduced or used without the consent of EXM

Ce dessin est confidentiel et ne doit pas être reproduit ou utilisé sans le consentement de EXM

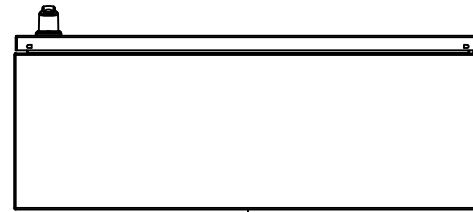

TOP

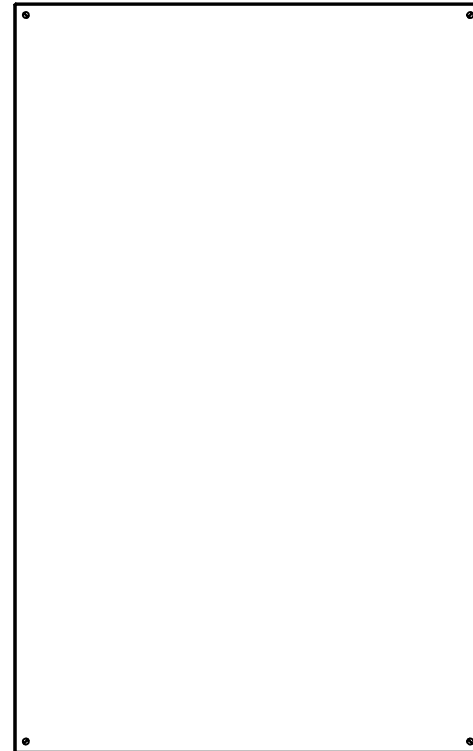

BACK



BOTTOM

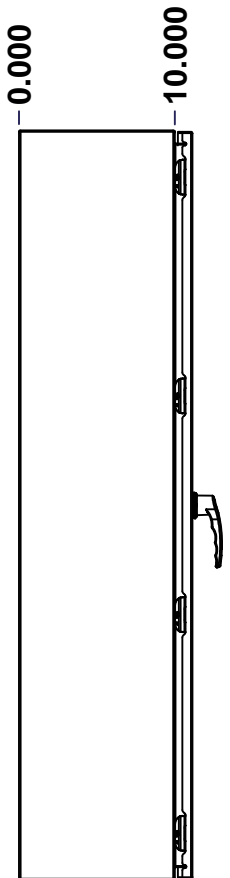

LEFT

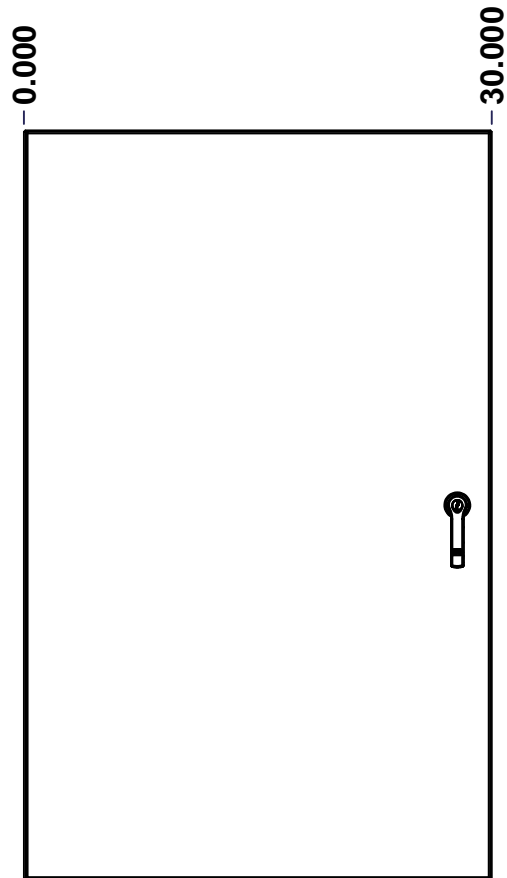

FRONT

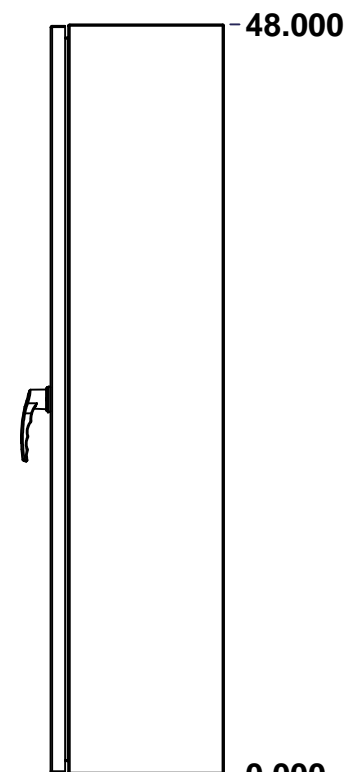

RIGHT

No.	Revisions	Date	By/Par

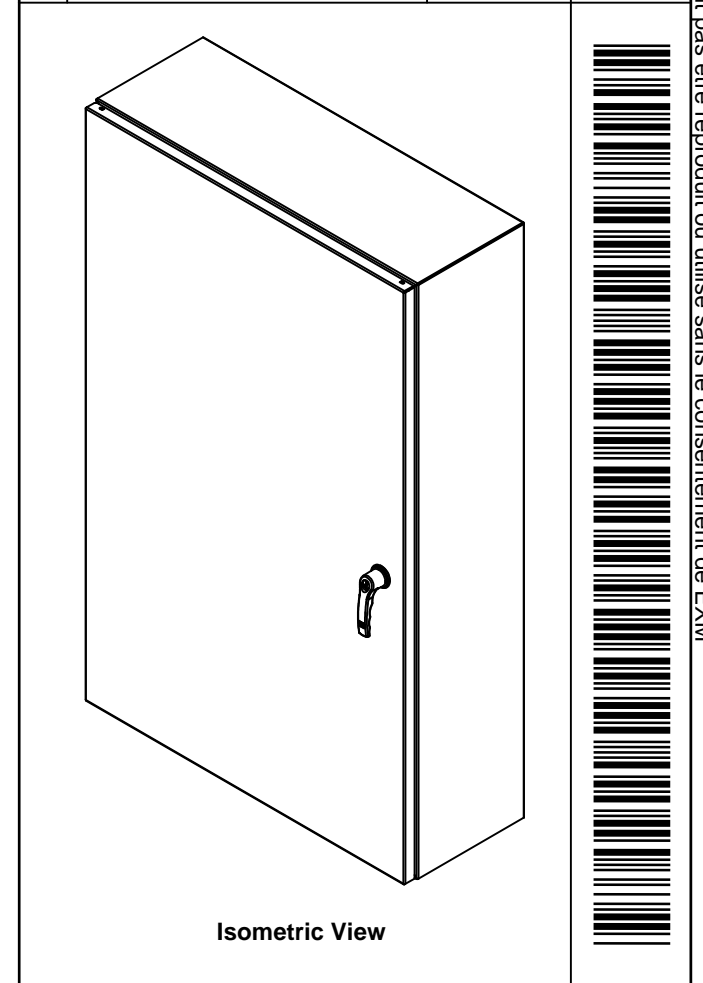

Isometric View

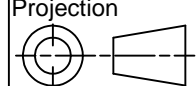

 Tél: (450) 979-4373 Fax: (450) 979-4626 www.exmweb.com		Flatness Aplatissement Max 3.0mm Projection 
Customer Client	Date	
Drawn By Dessiné Par	BoxCad: Annie	Date 27/03/2015
Material Matière	Aluminum 5052-H32 (1.7mm)	
Color Couleur	Asa-61 Grey	Finish Fini Smooth
Description	Detail Rev.	
5412EALBU 48" x 30" x 10" Assembly		
Part Number Numéro Pièce	Rev.	1
5412EALBU483010	0	2

SEE BILL OF MATERIAL ON LAST PAGE

This drawing is confidential and must not be reproduced or used without the consent of EXM

Ce dessin est confidentiel et ne doit pas être reproduit ou utilisé sans le consentement de EXM

NOTE	
ITEM	DESCRIPTION
1	NEMA 4X Enclosure
2	C/W Standard ground studs on box and cover
3	C/W Standard door stiffener
4	C/W Standard inner panel (Sold seperately)
5	C/W Standard inner panel mounting studs

No.	Revisions	Date	By/Par

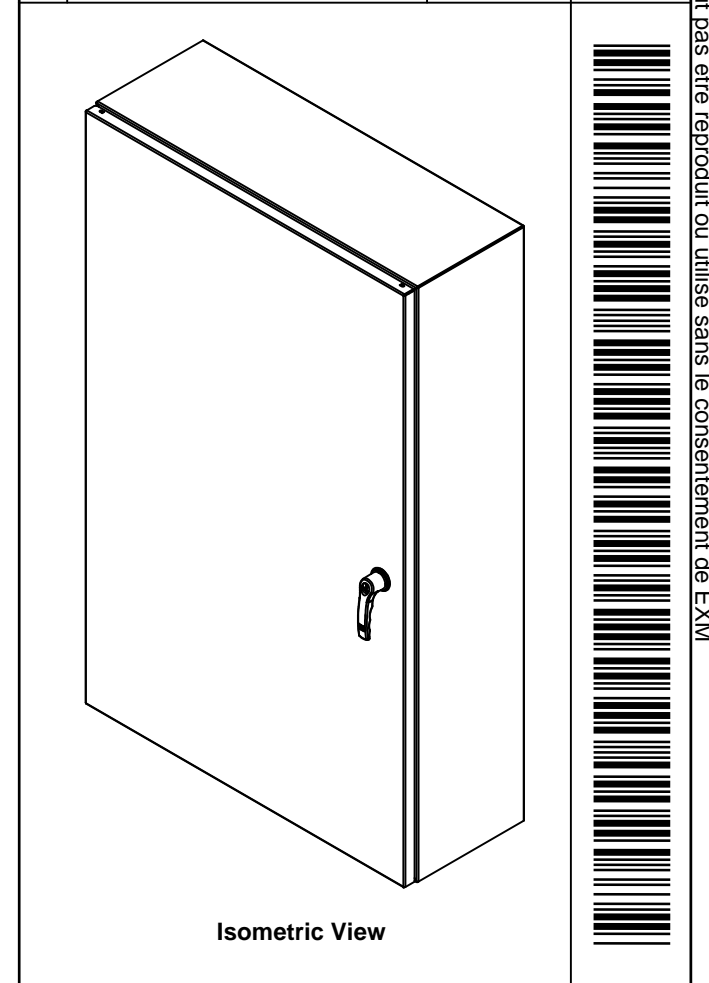

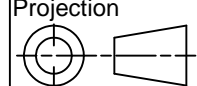
 Tél: (450) 979-4373 Fax: (450) 979-4626 www.exmweb.com		Flatness Aplatissement Max 3.0mm Projection 
Customer Client	Date	Date 27/03/2015
Drawn By Dessiné Par	BoxCad: Annie	
Material Matière	Aluminum 5052-H32 (1.7mm)	
Color Couleur	Asa-61 Grey	Finish Fini Smooth
Description	5412EALBU 48" x 30" x 10" Assembly	
Part Number Numéro Pièce	Rev. 0	2
5412EALBU483010		

Qty	Part Number	Rev	Description
1	880 PP	0	Self Adhesive Print Pocket
1	STK-K-01800	0	5412 ES Accessory Kit
8	STK-Q-03001	1	M5 x 8mm Stainless Steel Phillips Flat Head Screw
1	5412EALBU483010C	0	5412EALBU 48" x 30" Cover
4	STK-Q-07610	7	M8 Plastic Spacer 22.2mm
6	STK-Q-07310	2	Flange Lock Nut M8
1	881 SP4830	0	881 SP - Inner Panel
2	STK-Q-07615	0	Inner Panel Support Bracket
1	5412EALBU483010B	0	5412EALBU 48" x 30" x 10" Body
Parts List			

This drawing is confidential and must not be reproduced or used without the consent of EXM

Ce dessin est confidentiel et ne doit pas être reproduit ou utilisé sans le consentement de EXM

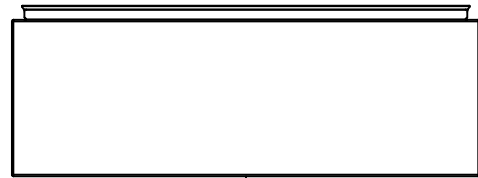

TOP

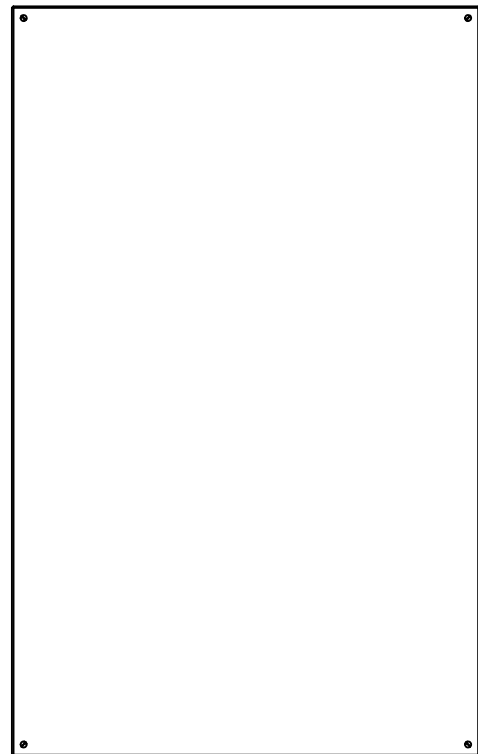

BACK

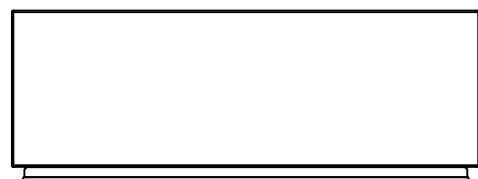

BOTTOM

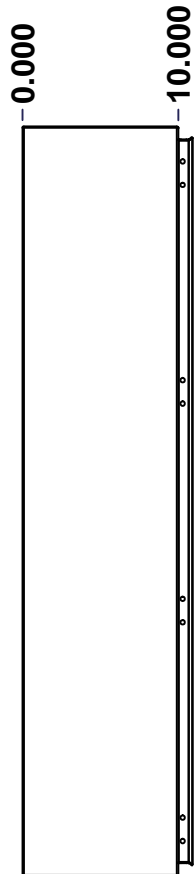

LEFT

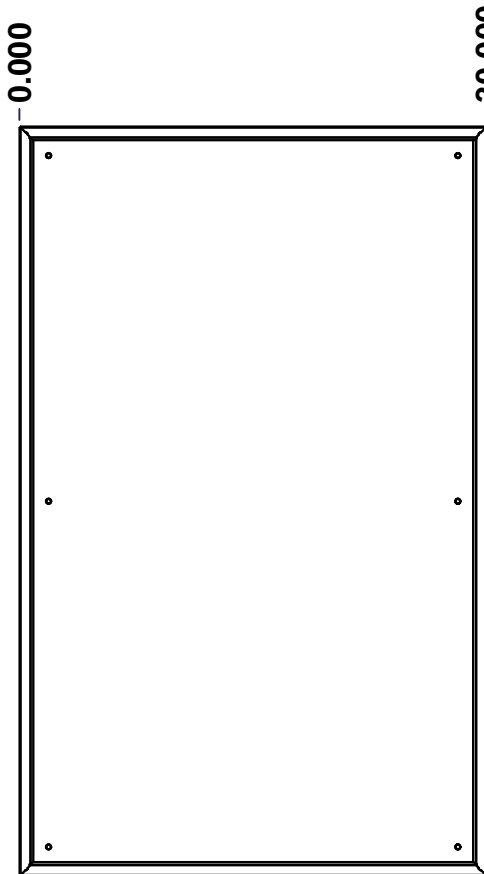

FRONT

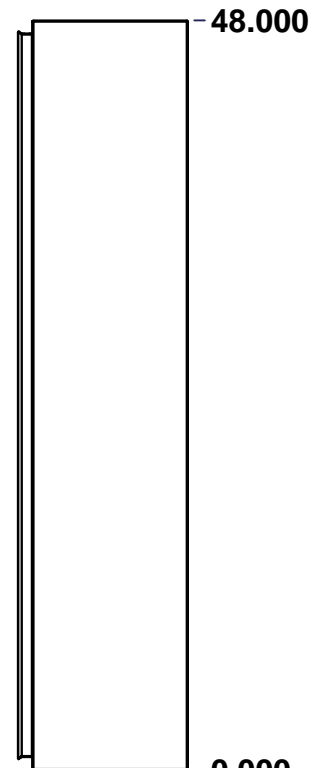

RIGHT

No.	Revisions	Date	By/Par

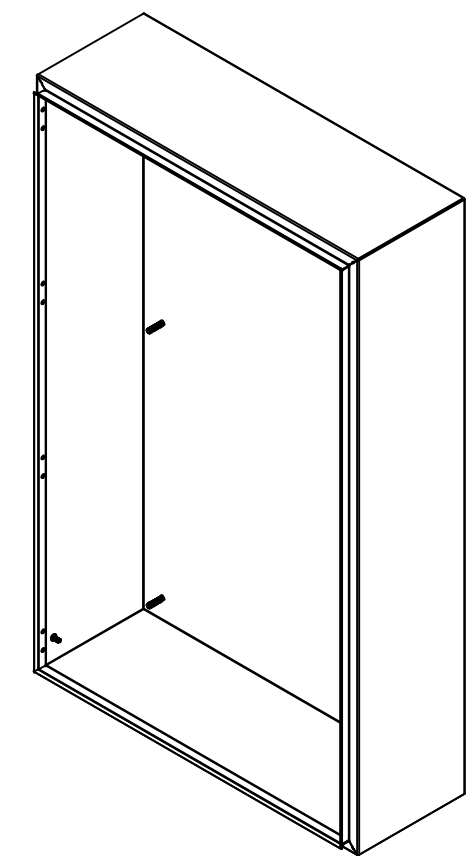

Isometric View



Tél: (450) 979-4373
 Fax: (450) 979-4626
www.exmweb.com

Flatness
Aplatissement
Max 3.0mm
Projection

Customer Client
 Drawn By Dessiné Par BoxCad: Annie
 Date 27/03/2015

Material Matière Aluminum 5052-H32 (1.7mm)

Color Couleur Asa-61 Grey
 Finish Fini Smooth

Description 5412EALBU 48" x 30" x 10" Body
 Detail Rev.

Part Number Numéro Pièce 5412EALBU483010B
 Rev. 0

SEE BILL OF MATERIAL ON LAST PAGE

1
7

This drawing is confidential and must not be reproduced or used without the consent of EXM

Ce dessin est confidentiel et ne doit pas être reproduit ou utilisé sans le consentement de EXM

STANDARD FEATURES ARE NOT LISTED IN THIS HOLE TABLE			
HOLE TABLE - LEFT VIEW (CUSTOM FEATURE ONLY)			
CUT-OUT	XDIM	YDIM	DESCRIPTION
1	8.500	2.000	GND STUD M6 x 16mm (Inside)

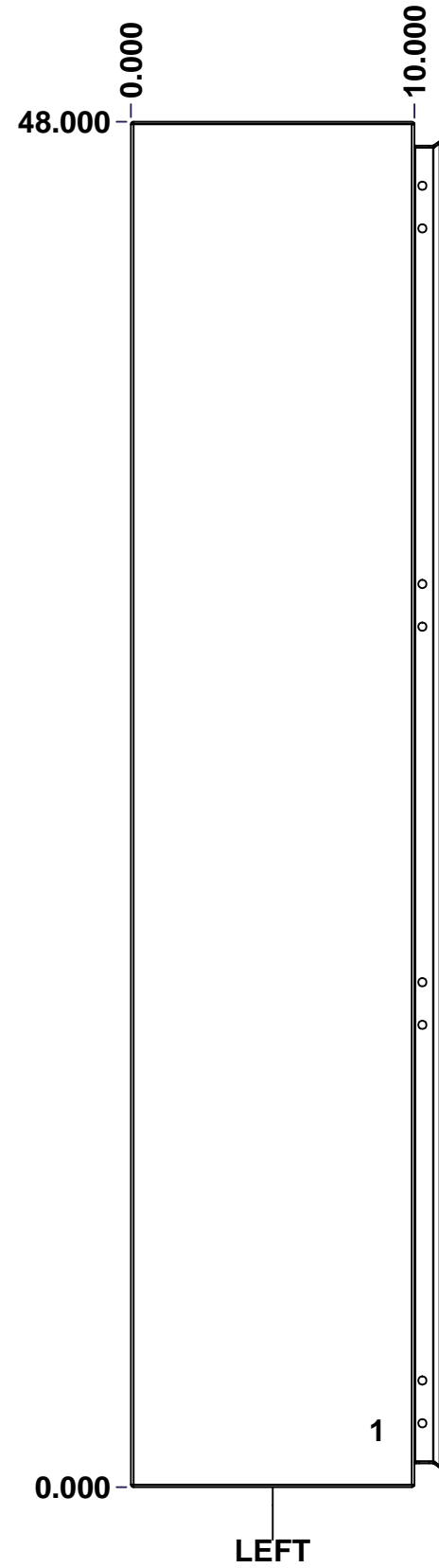

	Description	Status	
	5412EALBU 48" x 30" x 10" Body		
	Part Number Numéro Pièce	Rev.	
	5412EALBU483010B	0	5 / 7

This drawing is confidential and must not be reproduced or used without the consent of EXM

Ce dessin est confidentiel et ne doit pas être reproduit ou utilisé sans le consentement de EXM

STANDARD FEATURES ARE NOT LISTED IN THIS HOLE TABLE

HOLE TABLE - BACK VIEW (CUSTOM FEATURE ONLY)

CUT-OUT	XDIM	YDIM	DESCRIPTION
1	1.875	1.875	IP STUD M8 x 35mm (Inside)
2	1.875	46.125	IP STUD M8 x 35mm (Inside)
3	28.125	46.125	IP STUD M8 x 35mm (Inside)
4	28.125	1.875	IP STUD M8 x 35mm (Inside)
5	1.875	24.000	IP STUD M8 x 35mm (Inside)
6	28.125	24.000	IP STUD M8 x 35mm (Inside)

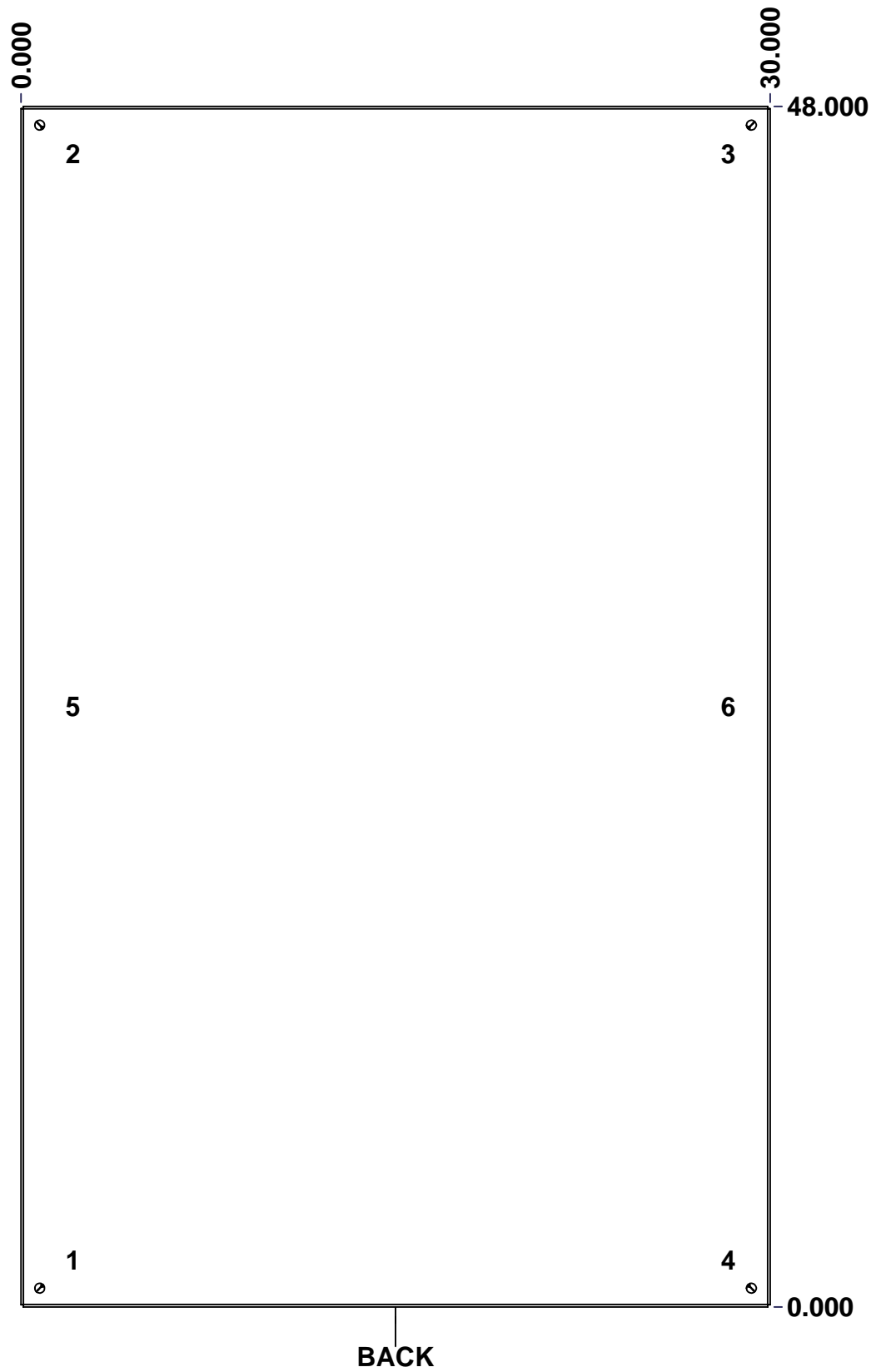

	Description	Status	
	5412EALBU 48" x 30" x 10" Body		
	Part Number Numéro Pièce	Rev.	
	5412EALBU483010B	0	6 / 7

This drawing is confidential and must not be reproduced or used without the consent of EXM

Ce dessin est confidentiel et ne doit pas être reproduit ou utilisé sans le consentement de EXM

No.	Revisions	Date	By/Par

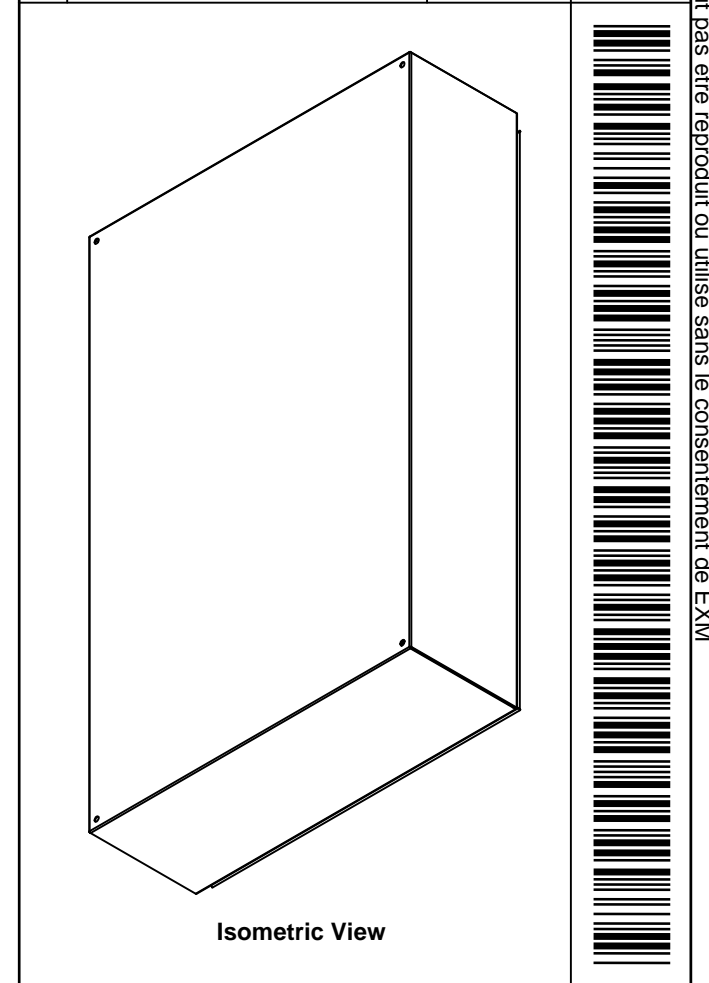

Tél: (450) 979-4373 Fax: (450) 979-4626 www.exmweb.com		Flatness Aplatissement	
		Max 3.0mm Projection	
Customer Client		Date	
Drawn By Dessiné Par BoxCad: Annie		Date 27/03/2015	
Material Matière Aluminum 5052-H32 (1.7mm)			
Color Couleur Asa-61 Grey		Finish Fini Smooth	
Description 5412EALBU 48" x 30" x 10" Body			Detail Rev.
Part Number Numéro Pièce 5412EALBU483010B		Rev. 0	7 / 7

Qty	Part Number	Rev	Description
1	STK-P-02400S	0	Powder Paint (Asa-61 Grey / Smooth)
6	STK-Q-16010	0	Stud M8 x 35mm Aluminum
1	STK-Q-16090	0	M6 x 16mm Aluminum Ground Stud
1	5412EALBU483010B-P	0	5412EALBU 48" x 30" x 10" Body Part
Parts List			

This drawing is confidential and must not be reproduced or used without the consent of EXM

Ce dessin est confidentiel et ne doit pas être reproduit ou utilisé sans le consentement de EXM

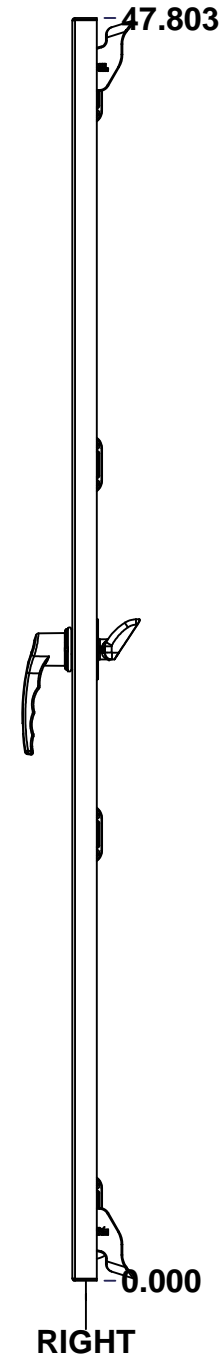
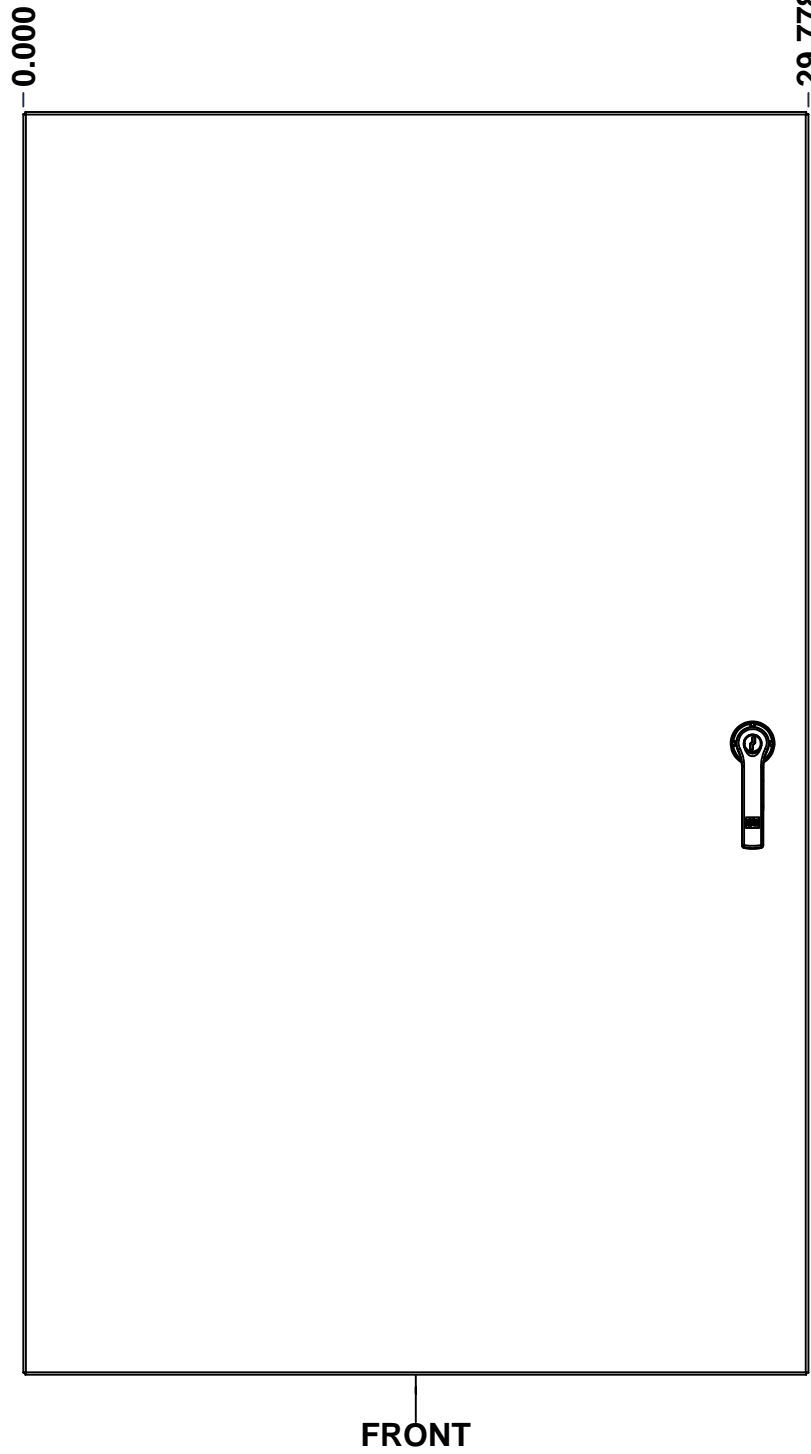
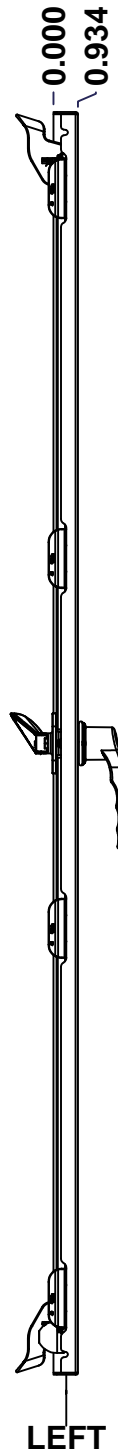
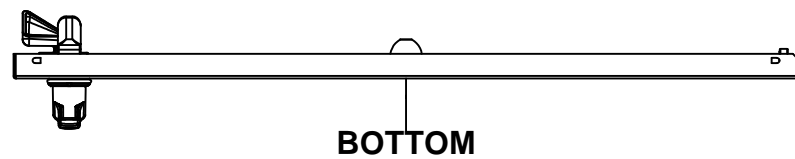
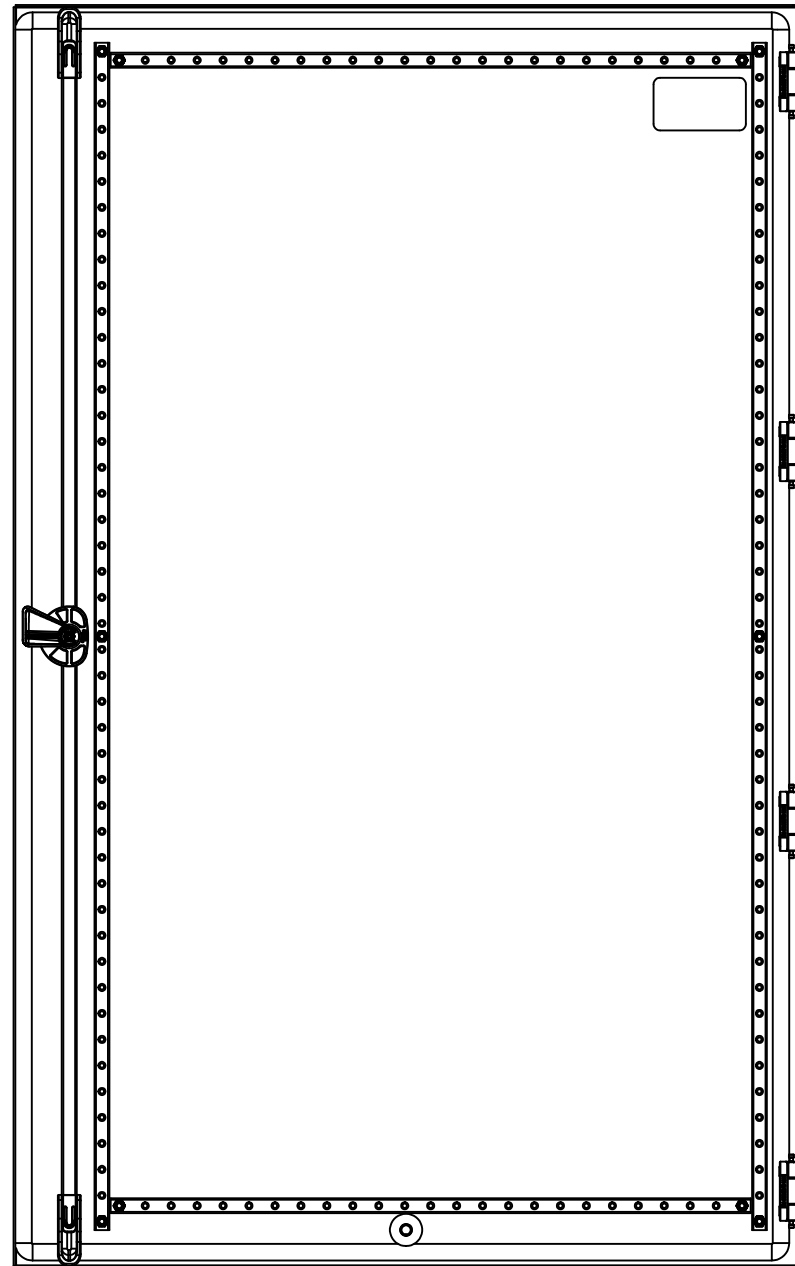
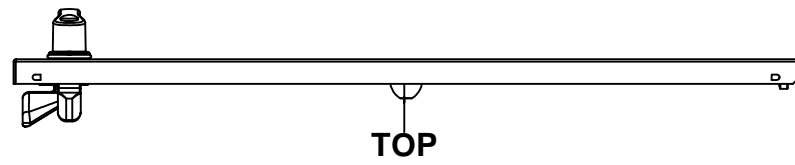

No.	Revisions	Date	By/Par

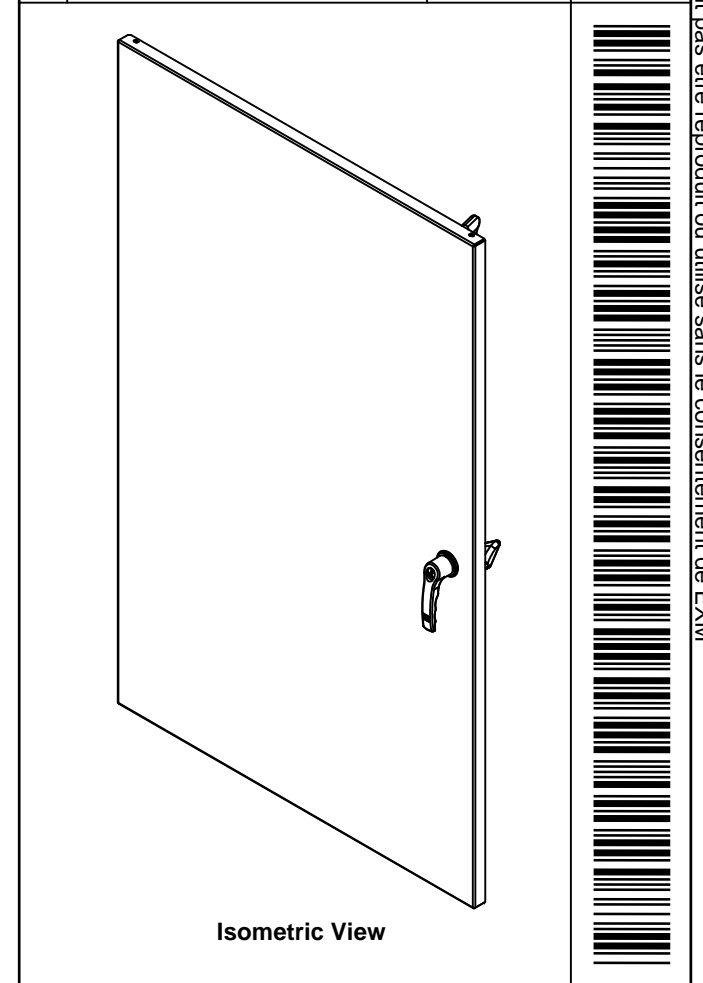

Tél: (450) 979-4373 Fax: (450) 979-4626 www.exmweb.com		Flatness Aplatissement Max 3.0mm Projection
Customer Client	Date	Date
Drawn By Dessiné Par	BoxCad: Annie	Date 27/03/2015
Material Matière	Aluminum 5052-H32 (1.7mm)	
Color Couleur	Asa-61 Grey	Finish Fini: Smooth
Description	Detail Rev.	
5412EALBU 48" x 30" Cover		
Part Number Numéro Pièce	Rev. 0	1 / 3

SEE BILL OF MATERIAL ON LAST PAGE

5412EALBU483010C

This drawing is confidential and must not be reproduced or used without the consent of EXM

Ce dessin est confidentiel et ne doit pas être reproduit ou utilisé sans le consentement de EXM

STANDARD FEATURES ARE NOT LISTED IN THIS HOLE TABLE

HOLE TABLE - FRONT VIEW (CUSTOM FEATURE ONLY)

CUT-OUT	XDIM	YDIM	DESCRIPTION
1	1.486	1.756	STUD M6 x 18mm (Inside)
2	1.486	46.047	STUD M6 x 18mm (Inside)
3	26.423	46.047	STUD M6 x 18mm (Inside)
4	26.423	1.756	STUD M6 x 18mm (Inside)
5	1.486	23.902	STUD M6 x 18mm (Inside)
6	26.423	23.902	STUD M6 x 18mm (Inside)
7	2.143	2.350	STUD M6 x 18mm (Inside)
8	2.143	45.713	STUD M6 x 18mm (Inside)
9	25.766	45.713	STUD M6 x 18mm (Inside)
10	25.766	2.350	STUD M6 x 18mm (Inside)
11	27.803	42.896	CLOSING BAR STUD (Inside)
12	27.803	4.907	CLOSING BAR STUD (Inside)
13	14.959	1.435	STUD M6 x 18mm (Inside)

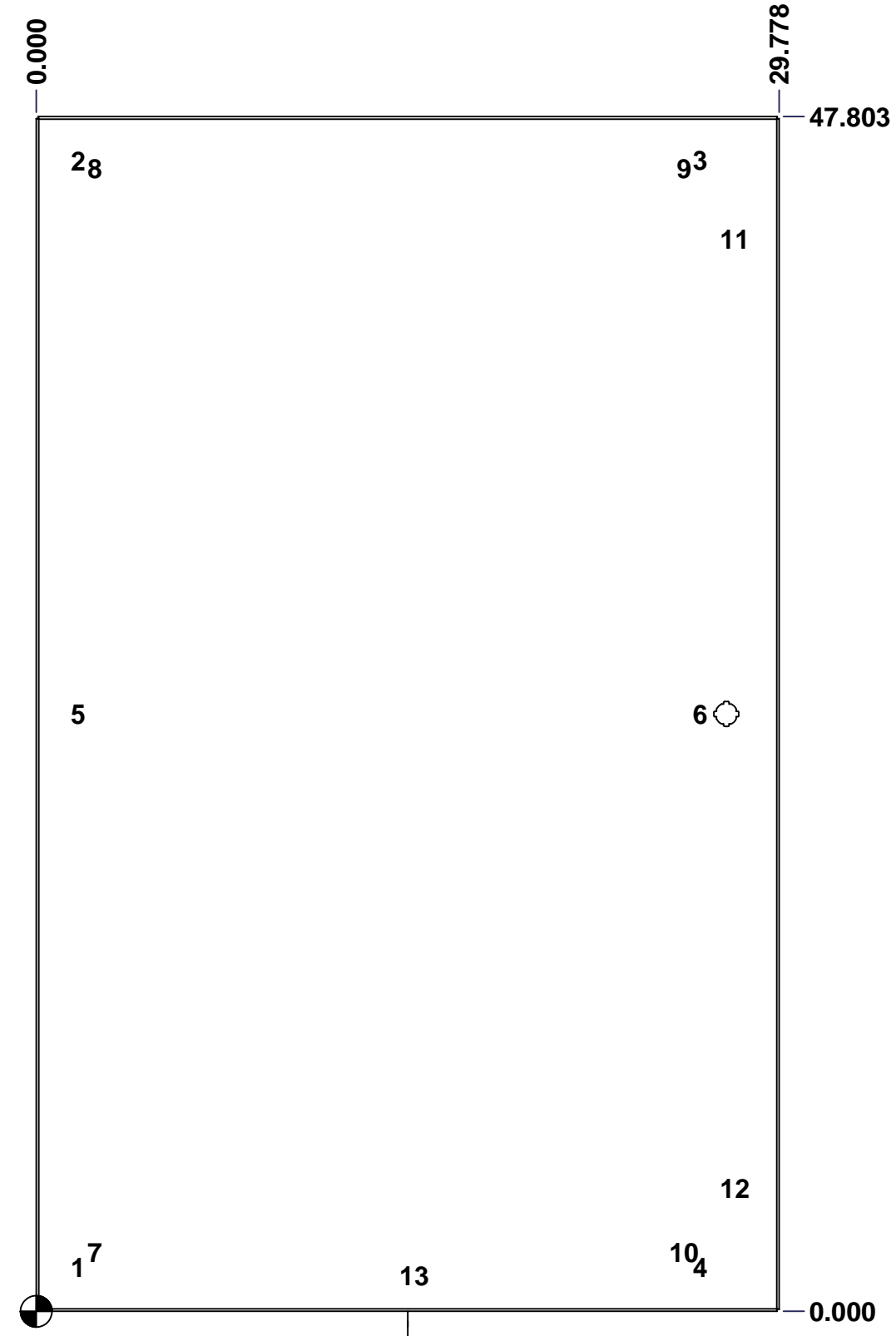

FRONT

	Description	Status
	5412EALBU 48" x 30" Cover	(NULL)
	Part Number Numéro Pièce	Rev.
	5412EALBU483010C	0
		2
		3

This drawing is confidential and must not be reproduced or used without the consent of EXM

Ce dessin est confidentiel et ne doit pas être reproduit ou utilisé sans le consentement de EXM

No.	Revisions	Date	By/Par

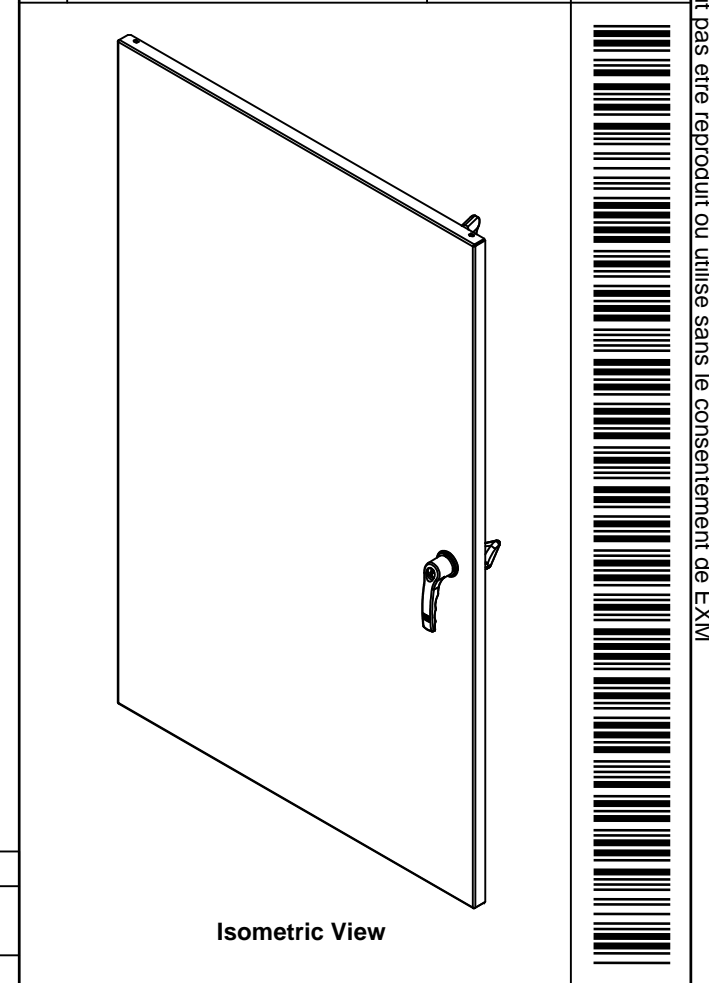

1	STK-P-02400S	0	Powder Paint (Asa-61 Grey / Smooth)
1	STK-S-00100	0.1.1	3.5" x 2" Silver Milar Flexcon Sticker
1	STK-Q-46515	3	5412 ES Door Support with Brass Insert
2	STK-Q-90042	0	5412 ES - Cabinet Closing Bar End (Small)
2	STK-Q-45655-48	0	5412 ES - Closing Bar
1	STK-K-50536	4	Handle Gear Clockwise Assy (Grip 32mm)
2	STK-Q-16405	2	Guide Stud - Small (No Paint Cap Required)
11	STK-Q-16060	0	Stud M6 x 18mm Aluminum
1	885 ESL2A	0	5412 ES Key Lock L-Handle (3 Pts)
1			
1			
4	STK-Q-33106	0	5412 ESSBU Buttable Hinge (Cover Part)
2	STK-Q-46025-30-3	4	5412 ES Horizontal Door Stiffener 30" (3Pts)
2	STK-Q-46020-48	5	5412 ES Vertical Door Stiffener 48"
1			
1			
1	5412EALBU483010G	0	5412EALBU 48" x 30" Cover Gasket
1	5412EALBU483010C-P	0	5412EALBU 48" x 30" Cover Part
10	STK-Q-07220	1	M6 Nylon Insert Lock Nut
Qty	Part Name	Rev	Description
Parts List			

Tél: (450) 979-4373 Fax: (450) 979-4626 www.exmweb.com	Flatness Aplatissement
	Max 3.0mm
Projection	
Customer Client	Date
Drawn By Dessiné Par	Date 27/03/2015
Material Matière	Aluminum 5052-H32 (1.7mm)
Color Couleur	Asa-61 Grey
Finish Fini	Smooth
Description	Detail Rev.
5412EALBU 48" x 30" Cover	
Part Number Numéro Pièce	Rev. 3
5412EALBU483010C	0 3

This drawing is confidential and must not be reproduced or used without the consent of EXM

Ce dessin est confidentiel et ne doit pas être reproduit ou utilisé sans le consentement de EXM

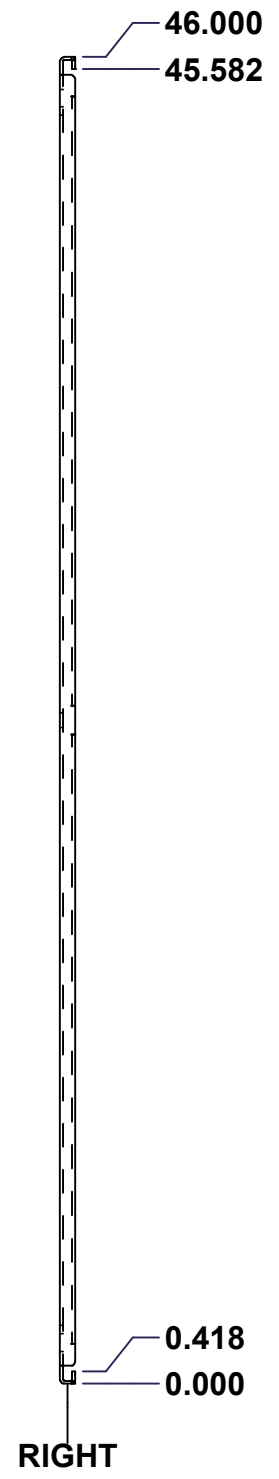
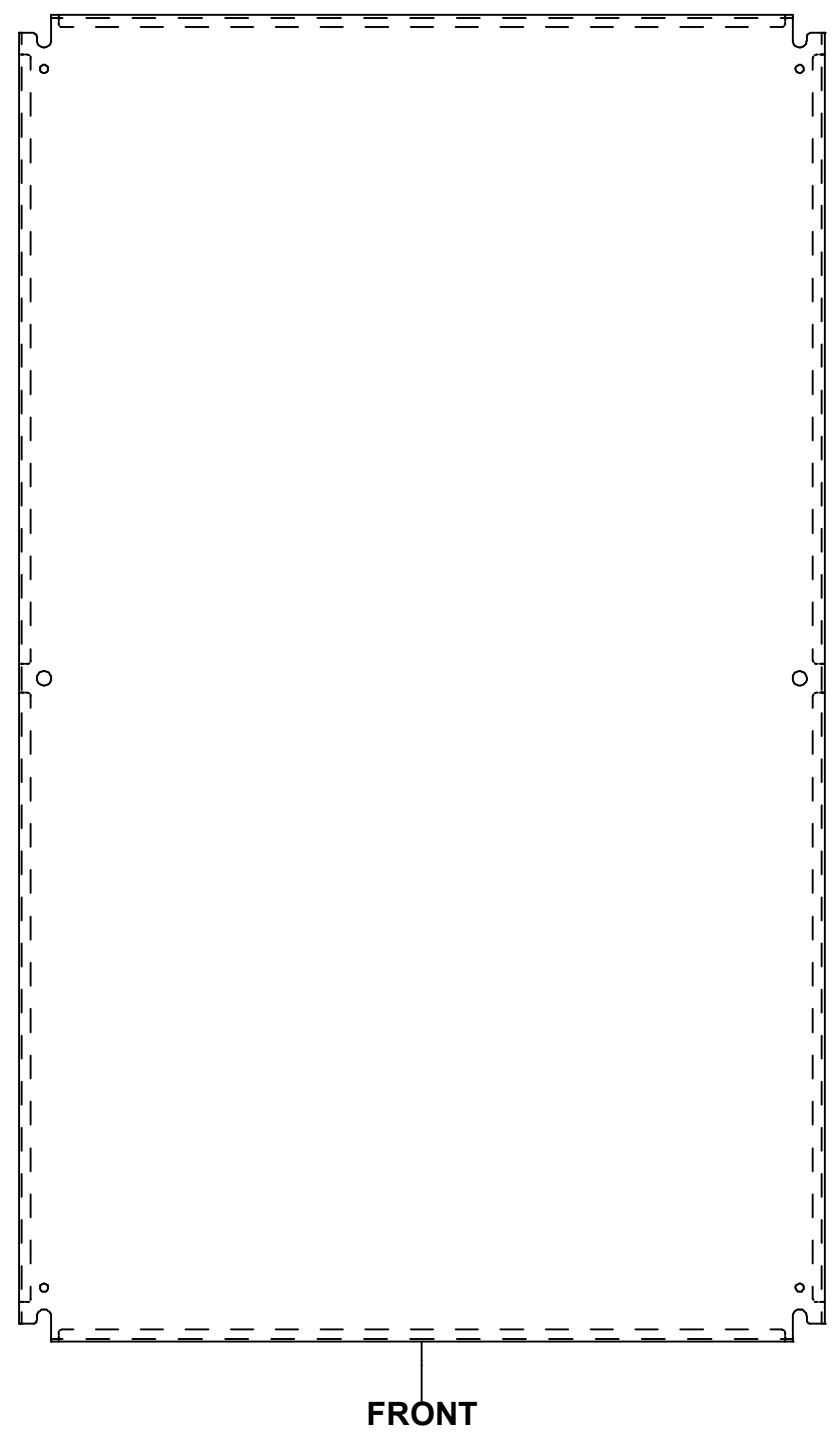
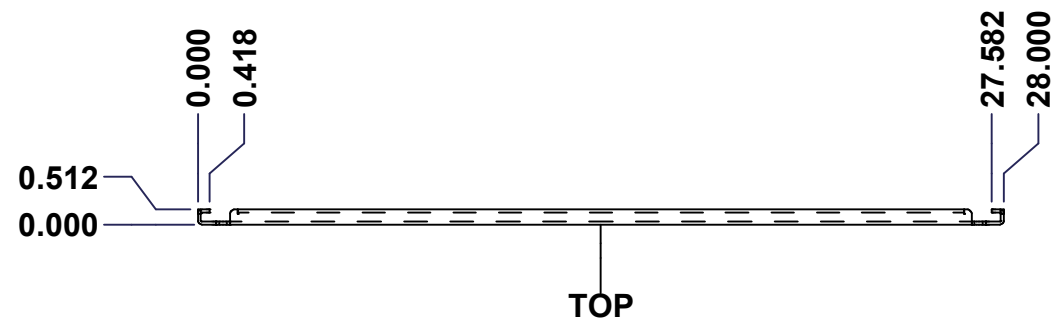

No.	Revisions	Date	By/Par

Isometric View

Tél: (450) 979-4373 Fax: (450) 979-4626 www.exmweb.com		Flatness Aplatissement Max 3.0mm Projection
Customer Client	Date	
Drawn By Dessiné Par	BoxCad	Date 1/23/2007
Material Matière	See Part List	
Color Couleur	See Part List	Finish Fini See Part List
Description		Detail Rev.
881 SP - Inner Panel		
Part Number Numéro Pièce	Rev. 0	1/2
881 SP4830		

Qty	Part Number	Rev	Description	Material	Color	Finish
1	STK-P-02401S	0	Powder Paint (White / Smooth)	Polyester-Epoxy Hybrid	White RAL9003	Smooth
1	881 SP4830-P	0	881 SP - Inner Panel Part	12 Ga H.R.P. & O.	White	Smooth

Parts List

This drawing is confidential and must not be reproduced or used without the consent of EXM

Ce dessin est confidentiel et ne doit pas être reproduit ou utilisé sans le consentement de EXM

Table 1			FRONT VIEW
CUT-OUT	XDIM	YDIM	DESCRIPTION
1	0.875	1.875	GROUND HOLE (RND Ø0.290)
2	27.125	1.875	GROUND HOLE (RND Ø0.290)
3	0.875	44.125	GROUND HOLE (RND Ø0.290)
4	27.125	44.125	GROUND HOLE (RND Ø0.290)
5	0.875	23.000	MTG STUD HOLE (RND Ø0.500)
6	27.125	23.000	MTG STUD HOLE (RND Ø0.500)

All knockouts are actual size / Les disques défonçables sont grandeur réel

No.	Revisions	Date	By/Par

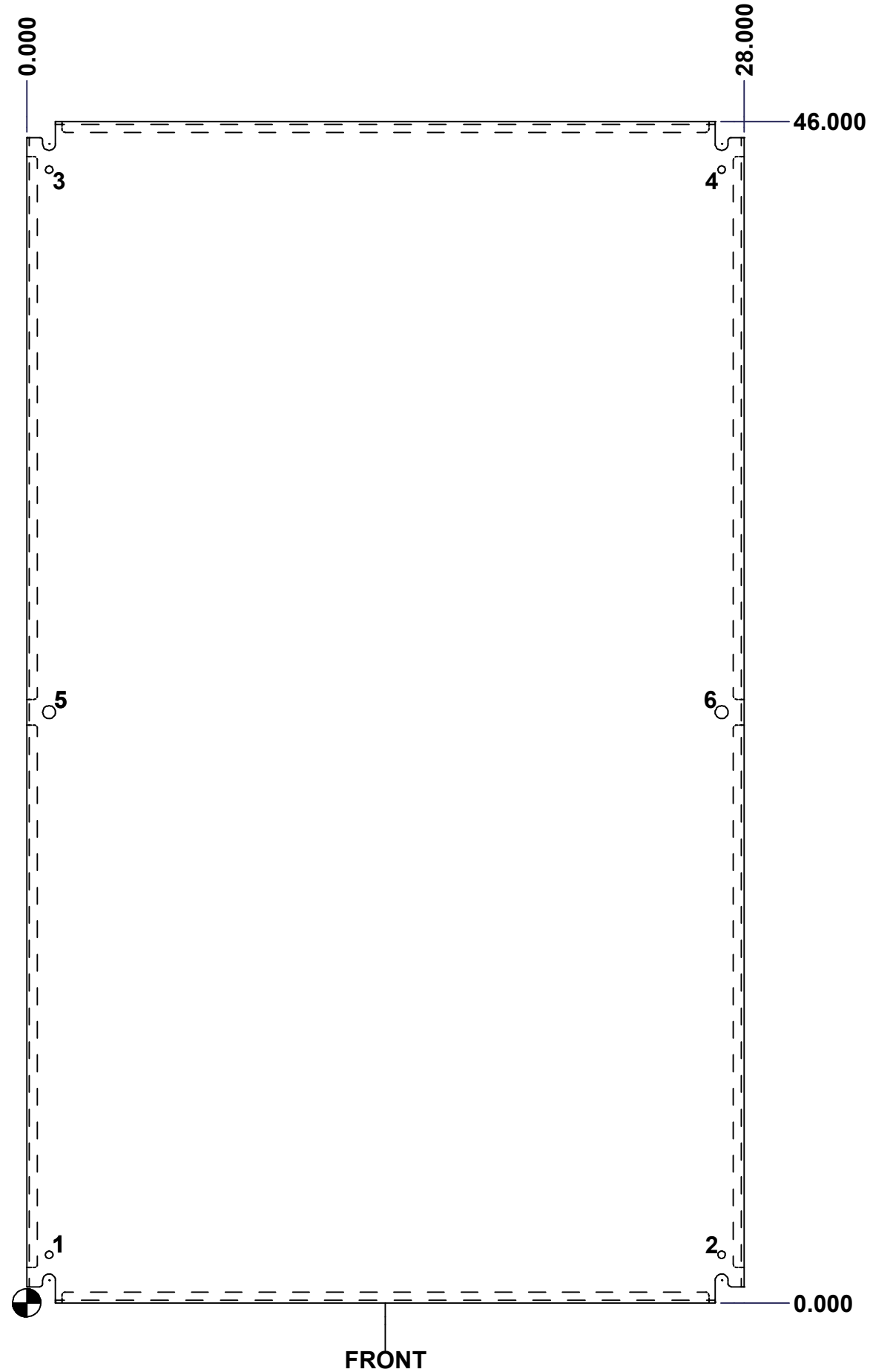

Isometric View

		Tél: (450) 979-4373 Fax: (450) 979-4626 www.exmweb.com		Flatness Aplatissement Max 3.0mm	
Customer Client		Date		Projection 	
Drawn By Dessiné Par		BoxCad		Date 1/23/2007	
Material Matière		See Part List			
Color Couleur		See Part List		Finish Fini See Part List	
Description 881 SP - Inner Panel				Detail Rev.	
Part Number Numéro Pièce 881 SP4830				Rev. 2 0	