

This drawing is confidential and must not be reproduced or used without the consent of EXM

Ce dessin est confidentiel et ne doit pas être reproduit ou utilisé sans le consentement de EXM

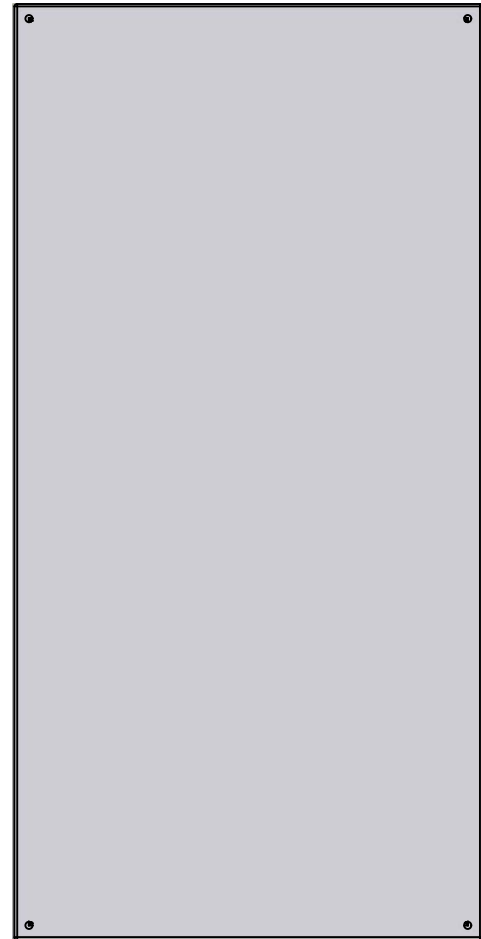

TOP



BACK

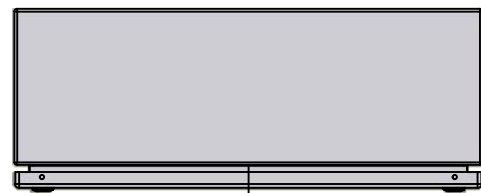

BOTTOM

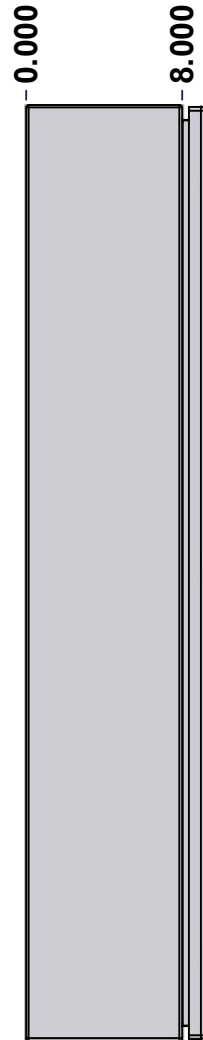

LEFT

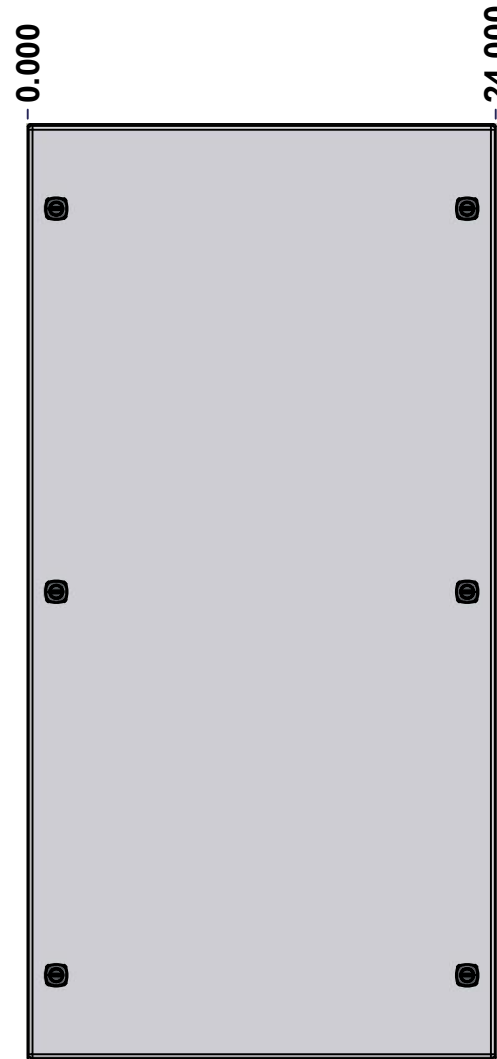

FRONT

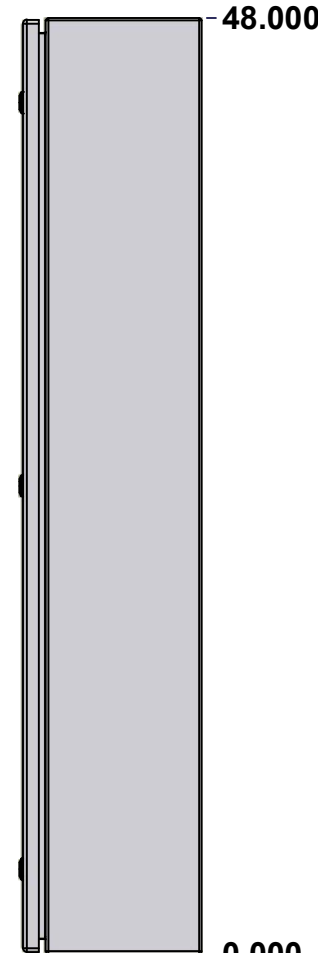

RIGHT

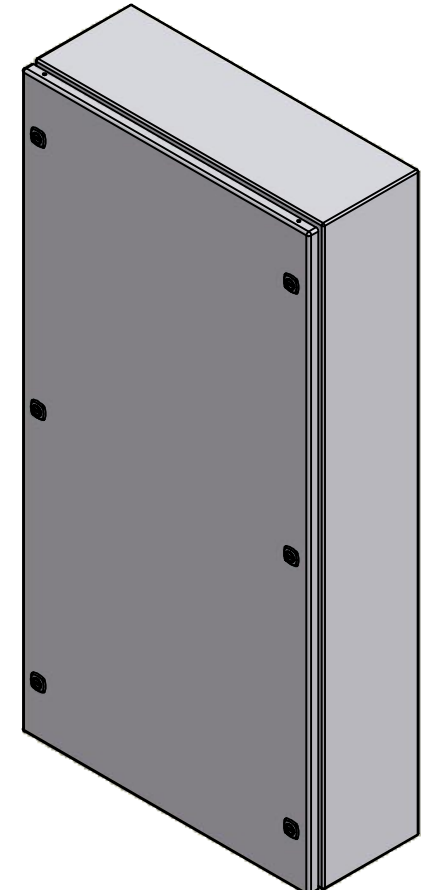

Isometric View

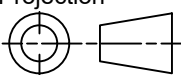

No.	Revisions	Date	By/Par

 Tél: (450) 979-4373 Fax: (450) 979-4626 www.exmweb.com		Flatness Aplatissement Max 3.0mm Projection 
Customer Client	Date	
Drawn By Dessiné Par	BoxCad: BoxCad	Date 12/9/2022
Material Matière	Aluminum 5052-H32 (2.5mm)	
Color Couleur	Asa-61 Grey	Finish Fini Smooth
Description	Detail Rev.	
5412EALQT 48" x 24" x 8" Assembly		
Part Number Numéro Pièce	Rev.	1
5412EALQT482408	0	9

SEE BILL OF MATERIAL ON LAST PAGE

This drawing is confidential and must not be reproduced or used without the consent of EXM

Ce dessin est confidentiel et ne doit pas être reproduit ou utilisé sans le consentement de EXM

NOTE	
ITEM	DESCRIPTION
1	NEMA 4X Enclosure
2	C/W Standard ground studs on box and cover
3	C/W Standard door stiffener
4	C/W Standard inner panel (Included)
5	C/W Standard inner panel mounting studs
6	C/W 880 PP included (Not installed)

No.	Revisions	Date	By/Par

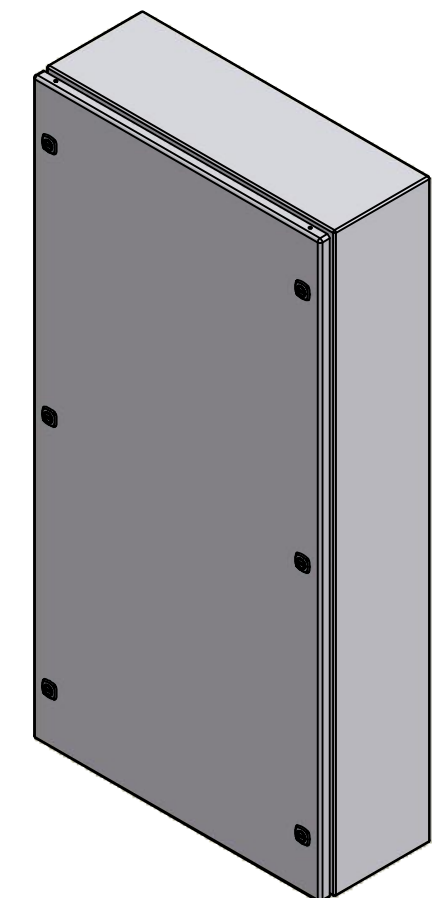

Isometric View



 Tél: (450) 979-4373
 Fax: (450) 979-4626
www.exmweb.com

Flatness
 Aplatissement
 Max 3.0mm
 Projection

Customer Client	Date
Drawn By Dessiné Par BoxCad: BoxCad	Date 12/9/2022

Material Matière	Aluminum 5052-H32 (2.5mm)
---------------------	---------------------------

Color Couleur	Asa-61 Grey	Finish Fini	Smooth
------------------	-------------	----------------	--------

Description	Detail Rev.
5412EALQT 48" x 24" x 8" Assembly	

Part Number Numéro Pièce	Rev.	2
5412EALQT482408	0	9

PACKING		
ITEM	QTY	DESCRIPTION
Cardboard sleeve	2	Top and Bottom
Cardboard strip	2	Between back of enclosure and inner panel
Plastic bag	1	To protect cover surface and inside gasket
Cardboard corner	4	To reinforced for the plastic strap tightening
Plastic strap - Black	2	To Squeeze the 2 cardboard sleeve together
Packaging label	3	White label with PN
Plastic strap- Green	2	To secure the enclosure to the wood pallet
Wood Pallet	1	2" deeper and 3" larger than enclosure size

Qty	Part Number	Rev	Description
2	STK-Q-07310	2	Flange Lock Nut M8
1	881 SP4824G	0	881 SP - Inner Panel
2	STK-Q-07615	0	Inner Panel Support Bracket
1	STK-K-01800	5	5412 ES Accessory Kit
2	STK-K-01320	0	5412 ES Inner Panel Accessory Kit
1	880 PP	6	Self Adhesive Print Pocket
1	5412EALQT482408C	0	5412EALQT 48" x 24" Cover
1	5412EALQT482408B	0	5412EALQT 48" x 24" x 8" Body
Parts List			

This drawing is confidential and must not be reproduced or used without the consent of EXM

Ce dessin est confidentiel et ne doit pas être reproduit ou utilisé sans le consentement de EXM



TOP

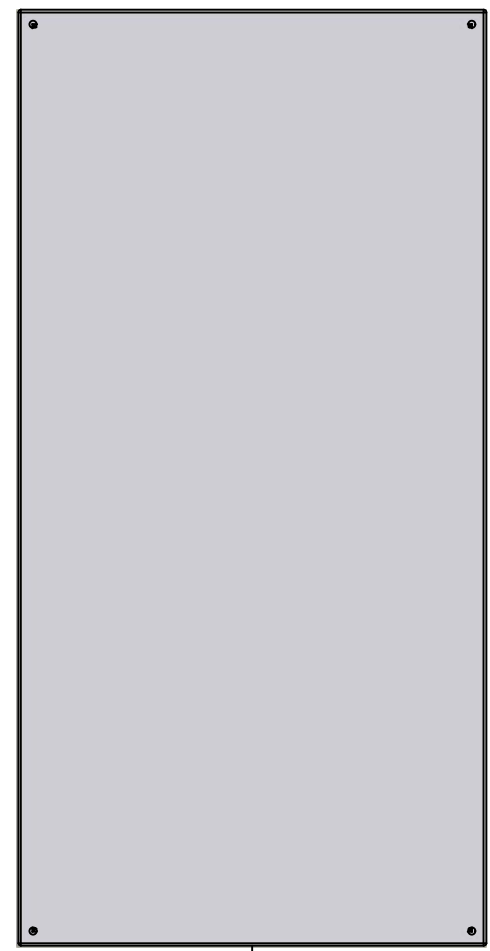

BACK

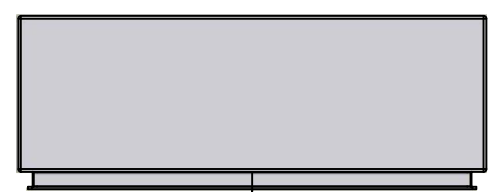

BOTTOM

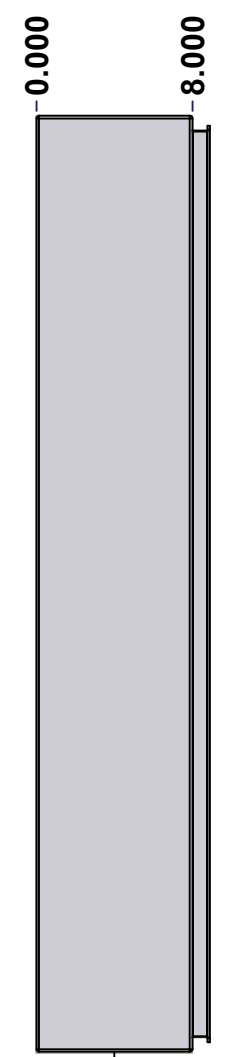

LEFT

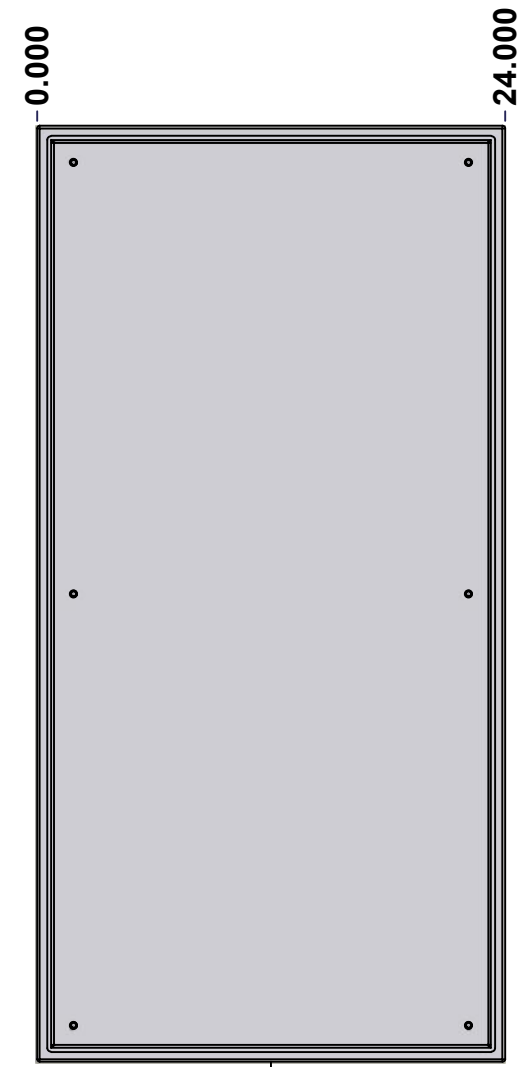

FRONT

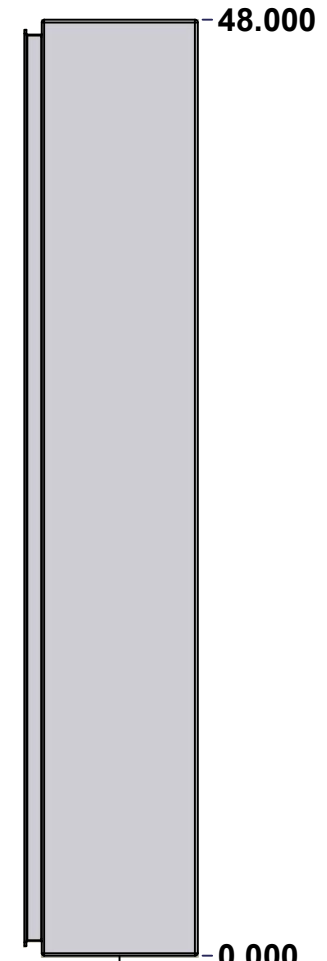

RIGHT

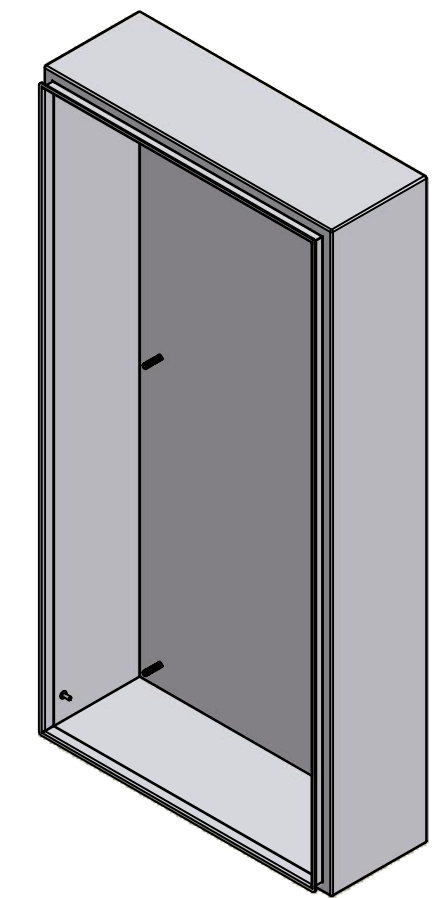

Isometric View

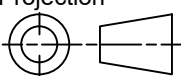

No.	Revisions	Date	By/Par

 Tél: (450) 979-4373 Fax: (450) 979-4626 www.exmweb.com		Flatness Aplatissement Max 3.0mm Projection 
Customer Client	Date	
Drawn By Dessiné Par	BoxCad: BoxCad	Date 12/9/2022
Material Matière	Aluminum 5052-H32 (2.5mm)	
Color Couleur	Asa-61 Grey	Finish Fini Smooth
Description	Detail Rev.	
5412EALQT 48" x 24" x 8" Body		
Part Number Numéro Pièce	Rev.	3
5412EALQT482408B	0	9

SEE BILL OF MATERIAL ON LAST PAGE

This drawing is confidential and must not be reproduced or used without the consent of EXM

Ce dessin est confidentiel et ne doit pas être reproduit ou utilisé sans le consentement de EXM

STANDARD FEATURES ARE NOT LISTED IN THIS HOLE TABLE			
HOLE TABLE - LEFT VIEW (CUSTOM FEATURE ONLY)			
CUT-OUT	XDIM	YDIM	DESCRIPTION
1	6.500	2.000	GND STUD M6 x 16mm (Inside)

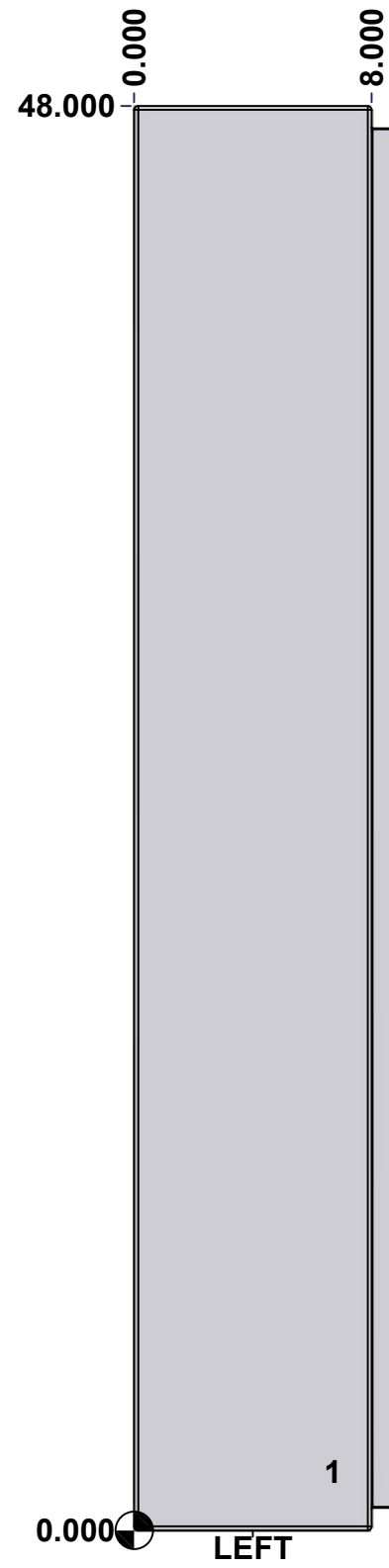

	Description	Status	
	5412EALQT 48" x 24" x 8" Body	(NULL)	
	Part Number Numéro Pièce	Rev.	
	5412EALQT482408B	0	4 9

This drawing is confidential and must not be reproduced or used without the consent of EXM

Ce dessin est confidentiel et ne doit pas être reproduit ou utilisé sans le consentement de EXM

STANDARD FEATURES ARE NOT LISTED IN THIS HOLE TABLE

HOLE TABLE - BACK VIEW (CUSTOM FEATURE ONLY)

CUT-OUT	XDIM	YDIM	DESCRIPTION
1	1.875	1.875	IP STUD M8 x 35mm (Inside)
2	1.875	46.125	IP STUD M8 x 35mm (Inside)
3	22.125	46.125	IP STUD M8 x 35mm (Inside)
4	22.125	1.875	IP STUD M8 x 35mm (Inside)
5	1.875	24.000	IP STUD M8 x 35mm (Inside)
6	22.125	24.000	IP STUD M8 x 35mm (Inside)

7	23.250	0.750	RND Ø0.390
8	23.250	47.250	RND Ø0.390
9	0.750	47.250	RND Ø0.390
10	0.750	0.750	RND Ø0.390

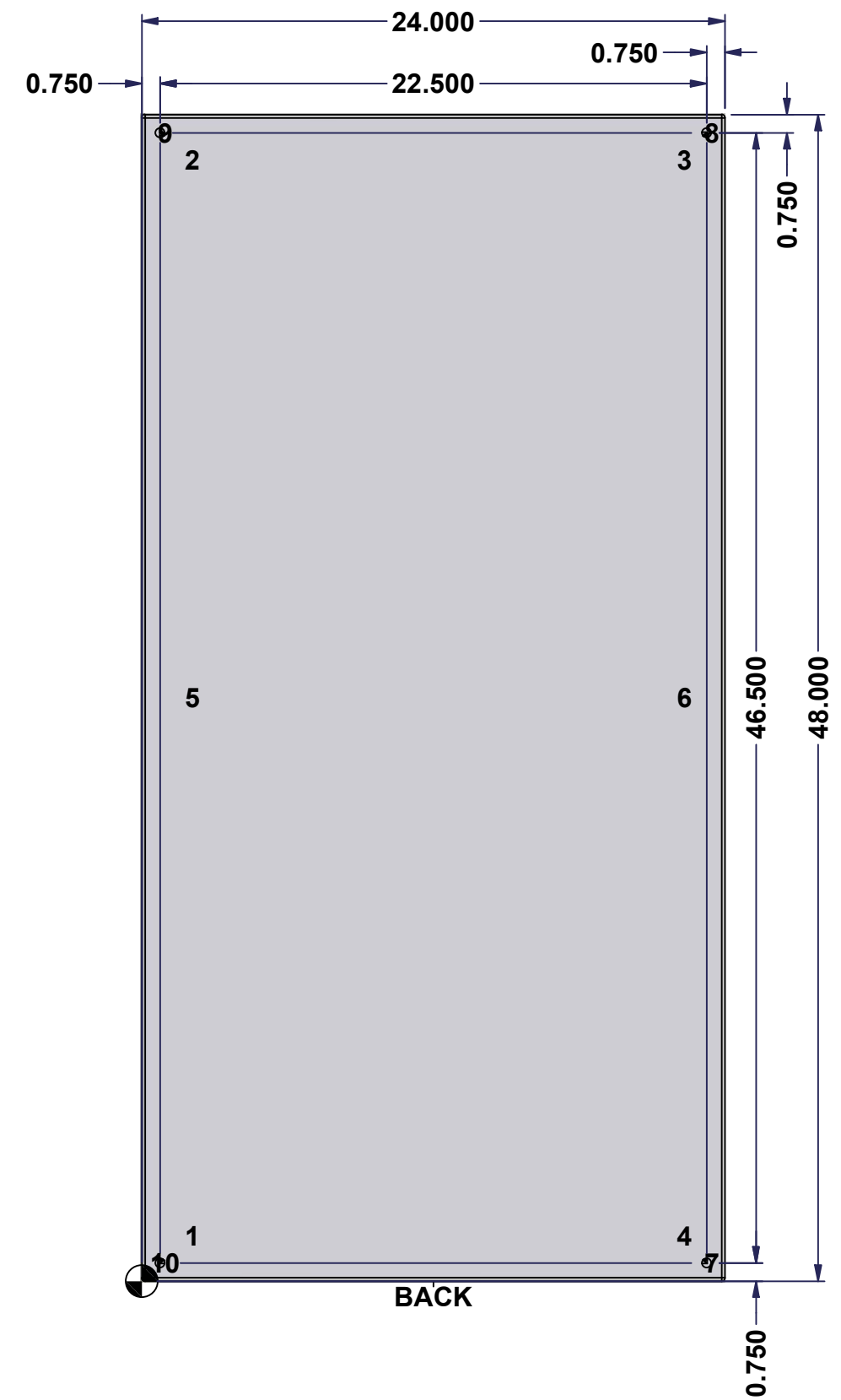

BACK

	Description	Status	
	5412EALQT 48" x 24" x 8" Body	(NULL)	
	Part Number Numéro Pièce	Rev.	
	5412EALQT482408B	0	5 9

This drawing is confidential and must not be reproduced or used without the consent of EXM

Ce dessin est confidentiel et ne doit pas être reproduit ou utilisé sans le consentement de EXM

No.	Revisions	Date	By/Par

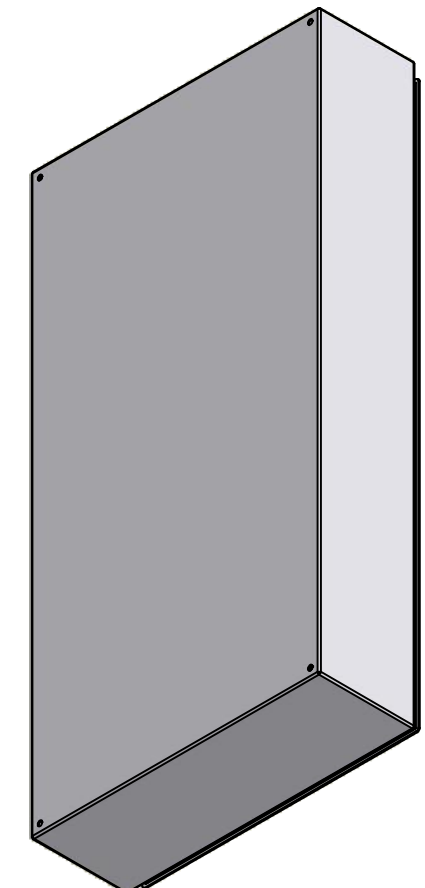

Isometric View

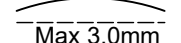

 Tél: (450) 979-4373 Fax: (450) 979-4626 www.exmweb.com		Flatness Aplatissement  Max 3.0mm
Customer Client		Date
Drawn By / Dessiné Par: BoxCad: BoxCad		Date: 12/9/2022
Material / Matière: Aluminum 5052-H32 (2.5mm)		
Color / Couleur: Asa-61 Grey	Finish / Fini: Smooth	
Description: 5412EALQT 48" x 24" x 8" Body		Detail Rev.
Part Number / Numéro Pièce: 5412EALQT482408B		Rev. 0

Qty	Part Number	Rev	Description
1	STK-Q-16090	0	Ground Stud M6 x 16mm Aluminum
1	STK-P-02400S	0	Powder Paint (Asa-61 Grey / Smooth)
6	STK-Q-16010	0	Stud M8 x 35mm Aluminum
1	5412EALQT482408B-P	0	5412EALQT 48" x 24" x 8" Body Part
Parts List			

This drawing is confidential and must not be reproduced or used without the consent of EXM

Ce dessin est confidentiel et ne doit pas être reproduit ou utilisé sans le consentement de EXM

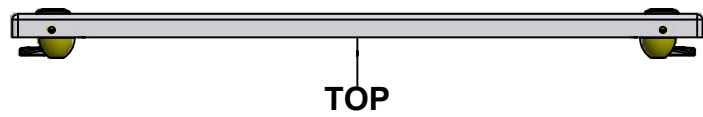

TOP

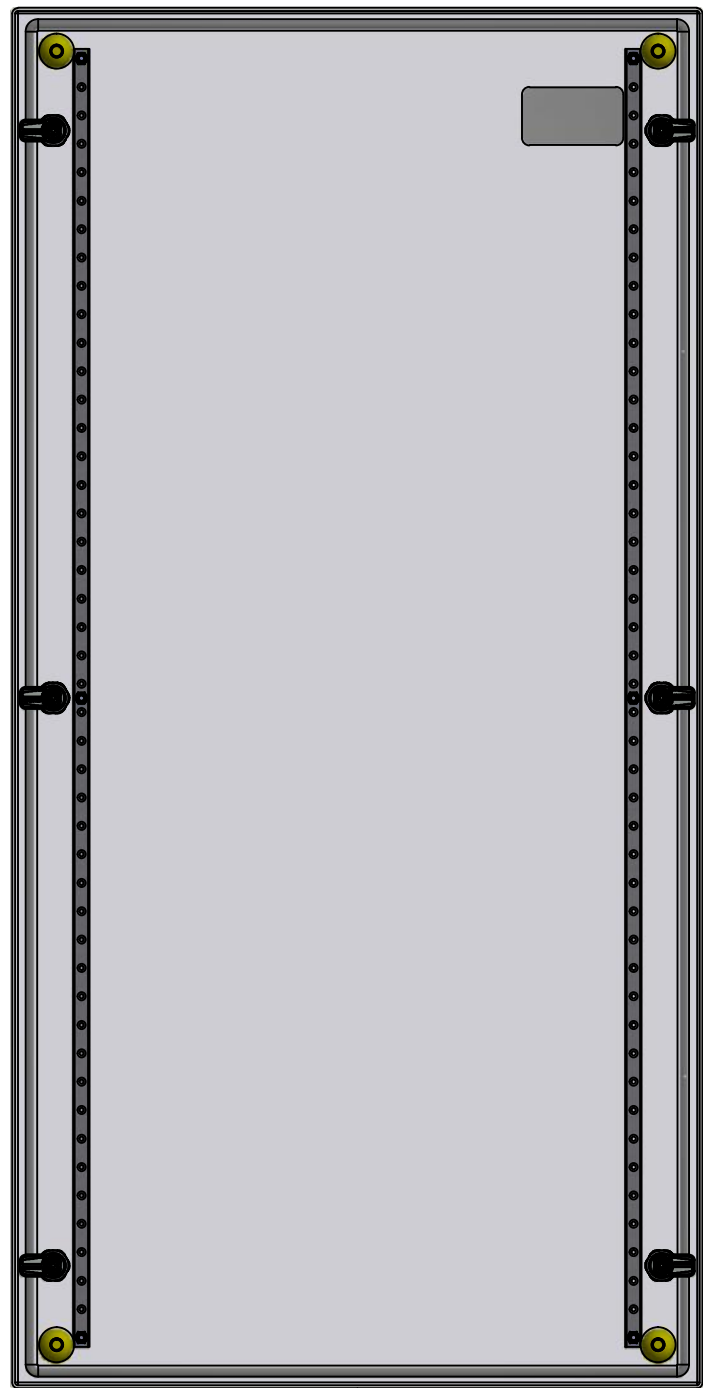

BACK



BOTTOM

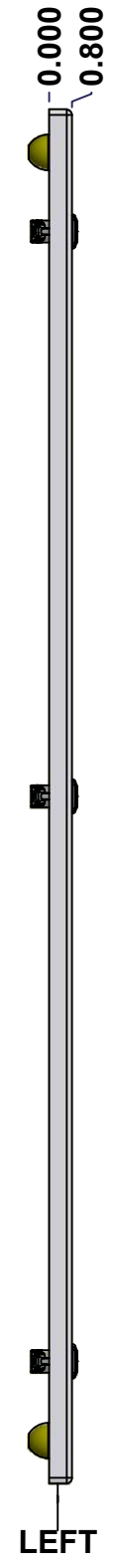

LEFT

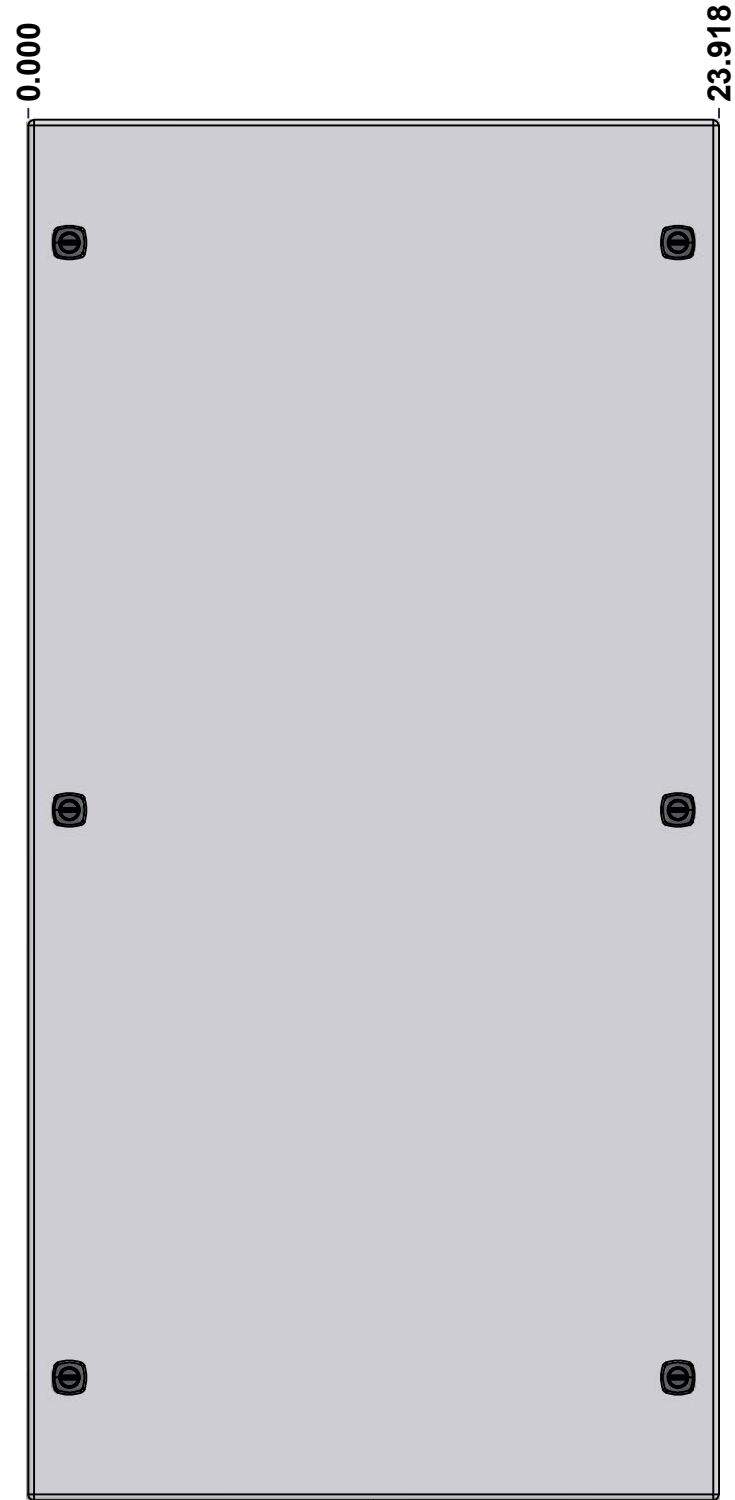

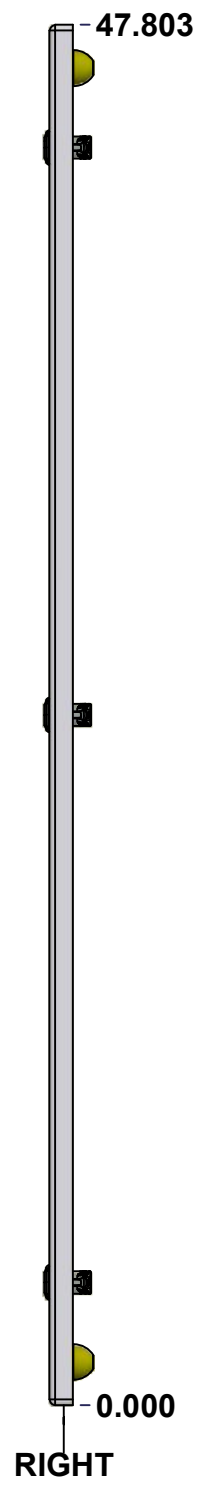

FRONT

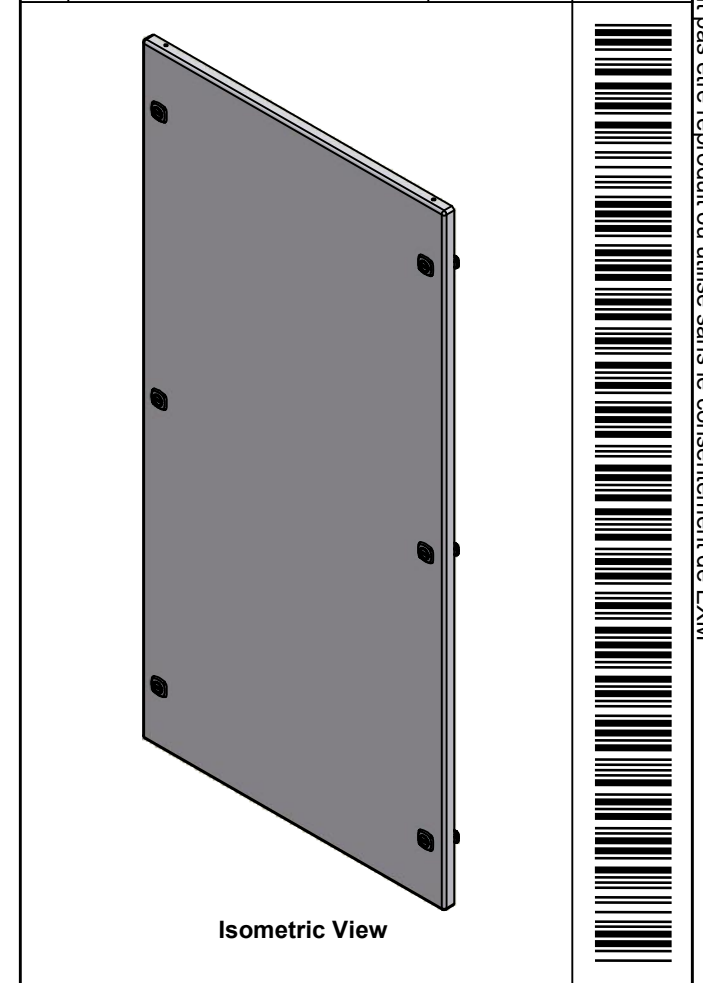

RIGHT

No.	Revisions	Date	By/Par



 Tél: (450) 979-4373 Fax: (450) 979-4626 www.exmweb.com		Flatness Aplatissement
		Max 3.0mm
Customer Client		Date
Drawn By Dessiné Par BoxCad: BoxCad		Date 12/9/2022
Material Matière Aluminum 5052-H32 (2.5mm)		
Color Couleur Asa-61 Grey	Finish Fini Smooth	
Description 5412EALQT 48" x 24" Cover		Detail Rev.
Part Number Numéro Pièce 5412EALQT482408C	Rev. 0	7 9

SEE BILL OF MATERIAL ON LAST PAGE

This drawing is confidential and must not be reproduced or used without the consent of EXM

Ce dessin est confidentiel et ne doit pas être reproduit ou utilisé sans le consentement de EXM

STANDARD FEATURES ARE NOT LISTED IN THIS HOLE TABLE			
HOLE TABLE - FRONT VIEW (CUSTOM FEATURE ONLY)			
CUT-OUT	XDIM	YDIM	DESCRIPTION
1	2.401	1.756	STUD M6 x 18mm (Inside)
2	2.401	46.047	STUD M6 x 18mm (Inside)
3	21.517	46.047	STUD M6 x 18mm (Inside)
4	21.517	1.756	STUD M6 x 18mm (Inside)
5	2.401	23.902	STUD M6 x 18mm (Inside)
6	21.517	23.902	STUD M6 x 18mm (Inside)
7	1.550	1.500	STUD M6 x 18mm (Inside)
8	22.368	1.500	STUD M6 x 18mm (Inside)
9	1.550	46.303	STUD M6 x 18mm (Inside)
10	22.368	46.303	STUD M6 x 18mm (Inside)

11	22.494	23.902	LOCK 880 SCQ4-SL @ 0.0°
12	22.494	4.250	LOCK 880 SCQ4-SL @ 0.0°
13	4.500	44.053	LABEL_EXM (Inside)
14	1.424	43.553	LOCK 880 SCQ4-SL @ 180.0°
15	1.424	23.902	LOCK 880 SCQ4-SL @ 180.0°
16	1.424	4.250	LOCK 880 SCQ4-SL @ 180.0°
17	22.494	43.553	LOCK 880 SCQ4-SL @ 0.0°

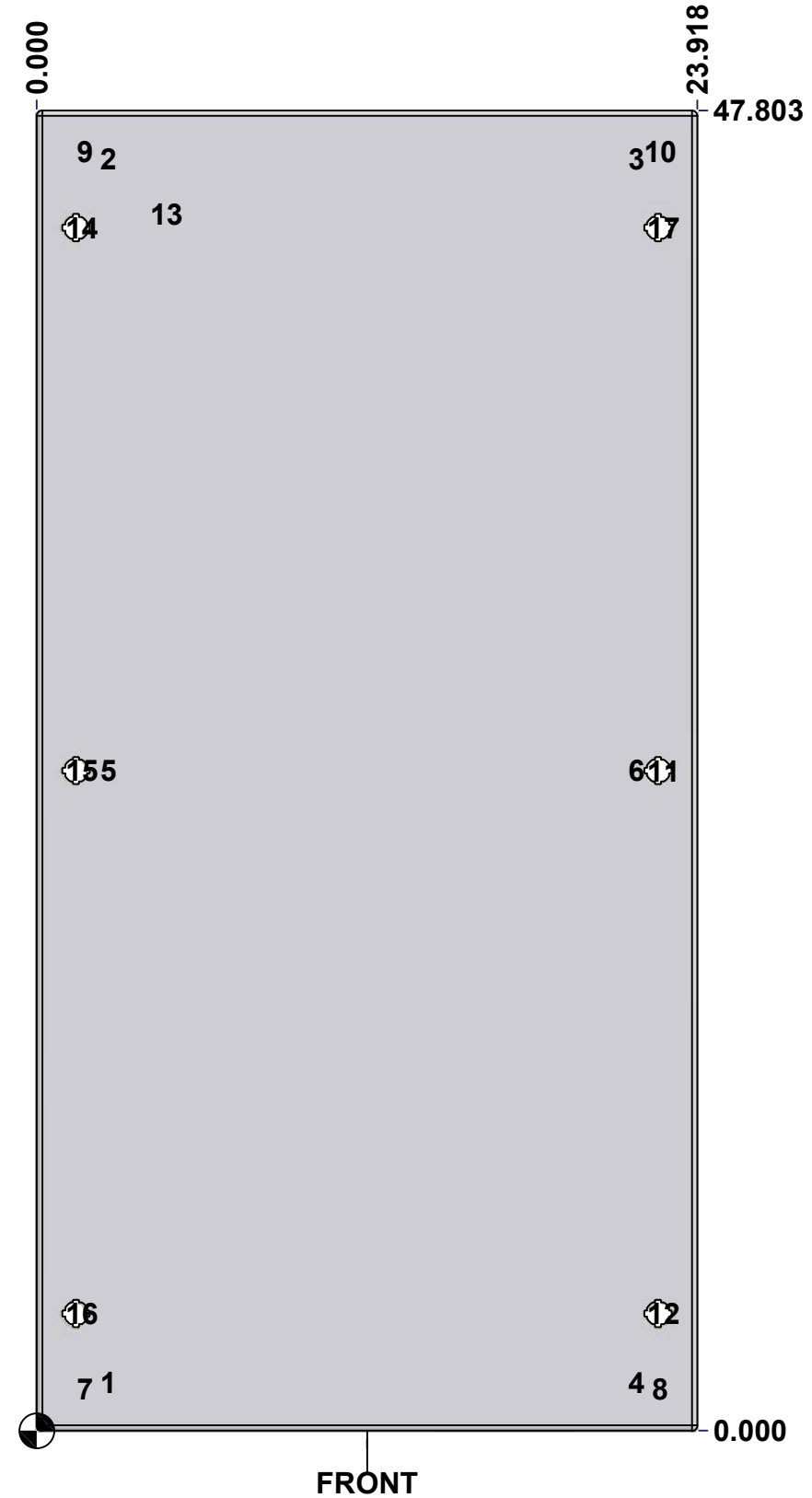

	Description	Status
	5412EALQT 48" x 24" Cover	(NULL)
	Part Number Numéro Pièce	Rev.
	5412EALQT482408C	0 / 8 / 9

This drawing is confidential and must not be reproduced or used without the consent of EXM

Ce dessin est confidentiel et ne doit pas être reproduit ou utilisé sans le consentement de EXM

No.	Revisions	Date	By/Par

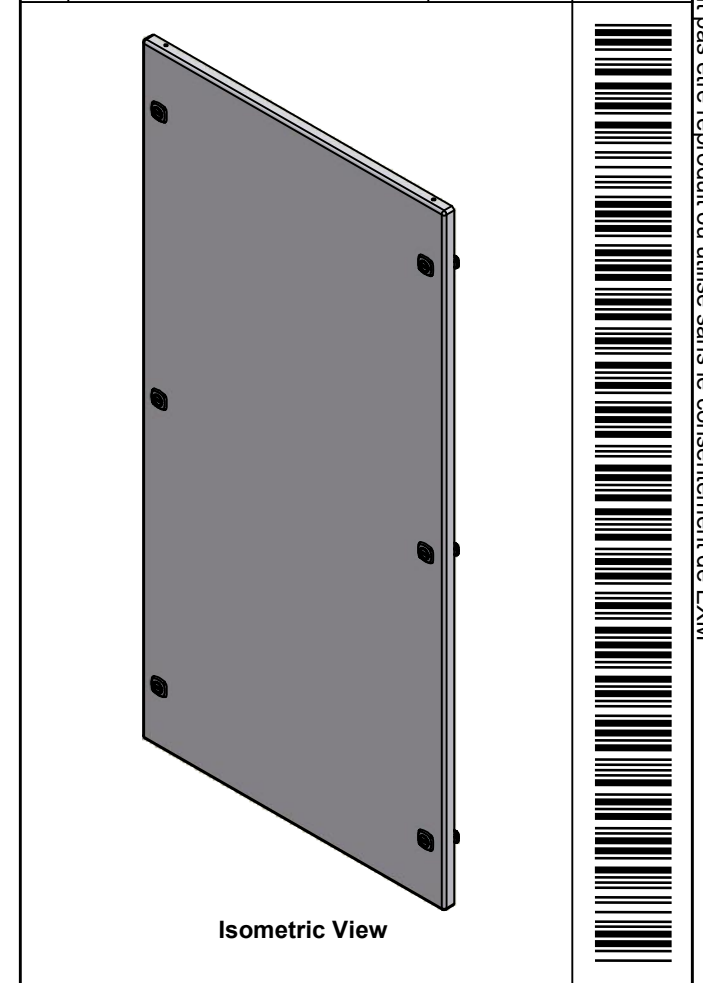

EXM
www.exmweb.com

Tél: (450) 979-4373
Fax: (450) 979-4626

Flatness
Aplatissement
Max 3.0mm

Projection

Customer Client _____ Date _____

Drawn By Dessiné Par BoxCad: BoxCad Date 12/9/2022

Material Matière Aluminum 5052-H32 (2.5mm)

Color Couleur Asa-61 Grey Finish Fini Smooth

Description 5412EALQT 48" x 24" Cover Detail Rev. _____

Part Number Numéro Pièce **5412EALQT482408C** Rev. **0** 9

Qty	Part Name	Rev	Description
1	STK-S-00100	0	3.5" x 2" Silver Milar Flexcon Sticker
1	STK-P-02400S	0	Powder Paint (Asa-61 Grey / Smooth)
2	STK-Q-46020-48	5	5412 ES Vertical Door Stiffener 48"
10	STK-Q-16060	0	Stud M6 x 18mm Aluminum
1	5412EALQT482408G	0	5412EALQT 48" x 24" Cover Gasket Part
1	5412EALQT482408C-P	0	5412EALQT 48" x 24" Cover Part
6	880 SCQ4-SL	6	5412 ES 1/4 Turn Lock
6	STK-Q-07220	1	M6 Nylon Insert Lock Nut
4	STK-Q-46515	3	5412 ES Door Support with Brass Insert
Parts List			

This drawing is confidential and must not be reproduced or used without the consent of EXM

Ce dessin est confidentiel et ne doit pas être reproduit ou utilisé sans le consentement de EXM

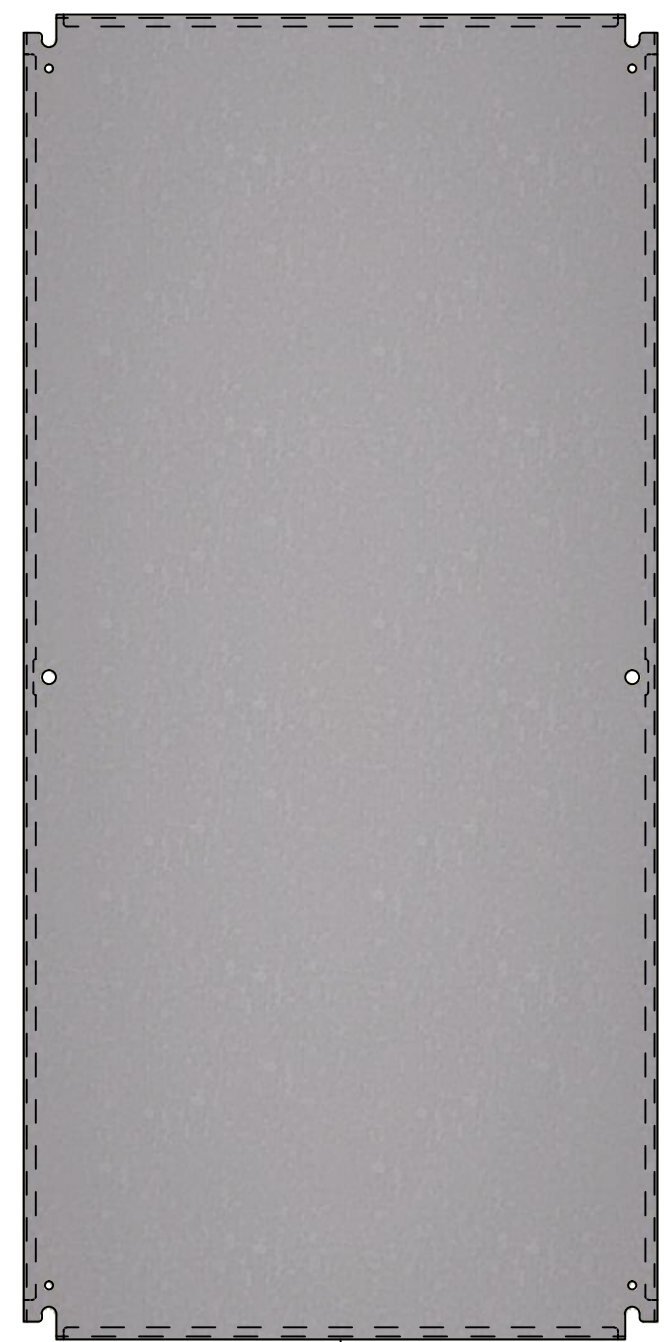
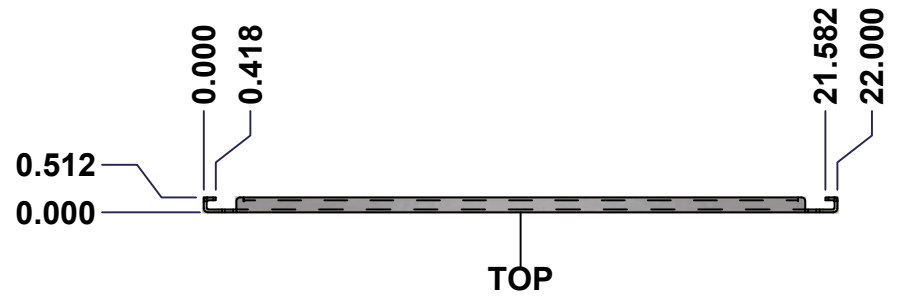

FRONT

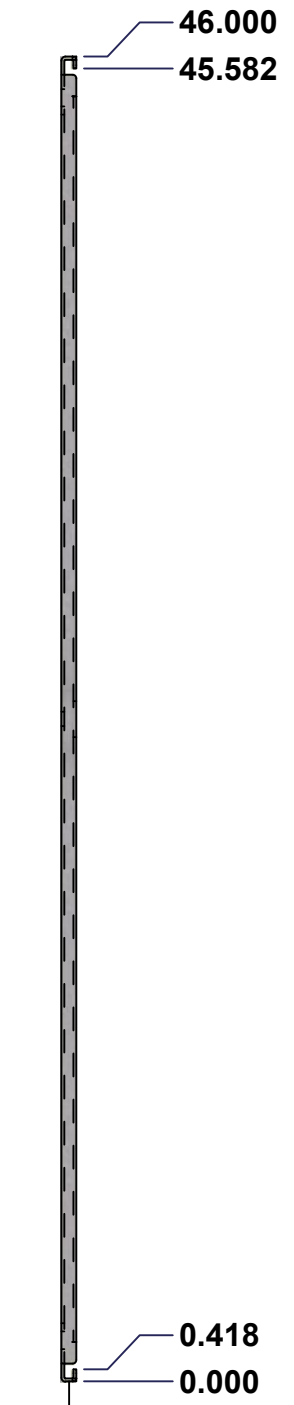

RIGHT

No.	Revisions	Date	By/Par

Isometric View

Tél: (450) 979-4373 Fax: (450) 979-4626 www.exmweb.com		Flatness Aplatissement Max 3.0mm
Customer Client		Date
Drawn By / Dessiné Par: BoxCad		Date: 23-Jan-07
Material / Matière: See Part List		
Color / Couleur: See Part List	Finish / Fini: See Part List	
Description: 881 SP - Inner Panel		Detail Rev.
Part Number / Numéro Pièce: 881 SP4824G		Rev. 1 0

Qty	Part Number	Rev	Description	Material	Color	Finish
1	881 SP4824G-P	0	881 SP - Inner Panel Part	12 Ga Galvanized	Unpainted	Galvanized

Parts List

This drawing is confidential and must not be reproduced or used without the consent of EXM

Ce dessin est confidentiel et ne doit pas être reproduit ou utilisé sans le consentement de EXM

Table 1			FRONT VIEW
CUT-OUT	XDIM	YDIM	DESCRIPTION
1	0.875	1.875	GROUND HOLE (RND Ø0.290)
2	21.125	1.875	GROUND HOLE (RND Ø0.290)
3	0.875	44.125	GROUND HOLE (RND Ø0.290)
4	21.125	44.125	GROUND HOLE (RND Ø0.290)
5	0.875	23.000	MTG STUD HOLE (RND Ø0.500)
6	21.125	23.000	MTG STUD HOLE (RND Ø0.500)

All knockouts are actual size / Les disques défonçables sont grandeur réel

No.	Revisions	Date	By/Par

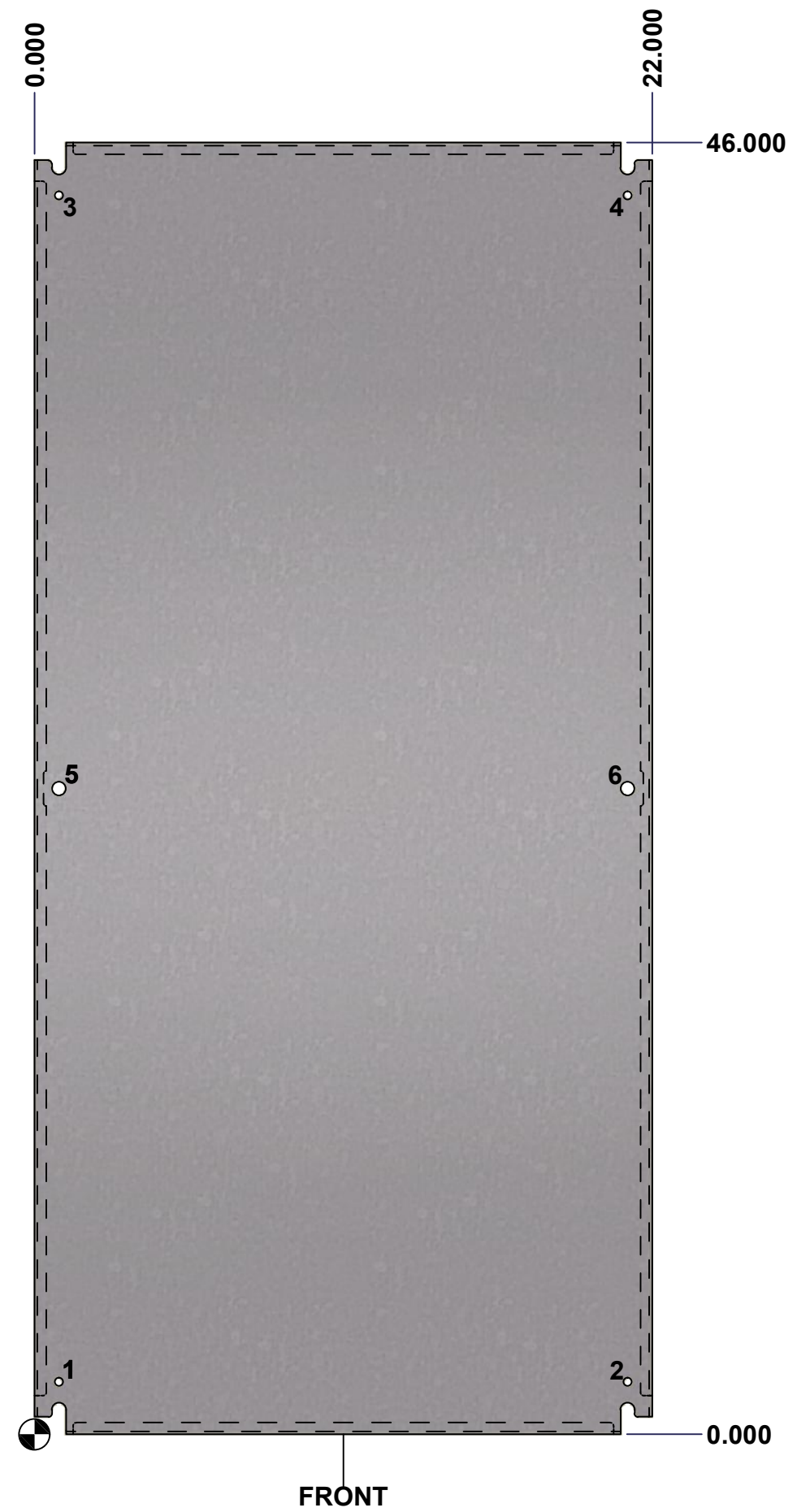

	Tél: (450) 979-4373 Fax: (450) 979-4626 www.exmweb.com	Flatness Aplatissement
		Max 3.0mm
Projection		
Customer Client		Date
Drawn By Dessiné Par	BoxCad	Date 23-Jan-07
Material Matière	See Part List	
Color Couleur	See Part List	Finish Fini See Part List
Description	Detail Rev.	
881 SP - Inner Panel		
Part Number Numéro Pièce	Rev.	2
881 SP4824G	0	2