

This drawing is confidential and must not be reproduced or used without the consent of EXM

Ce dessin est confidentiel et ne doit pas être reproduit ou utilisé sans le consentement de EXM

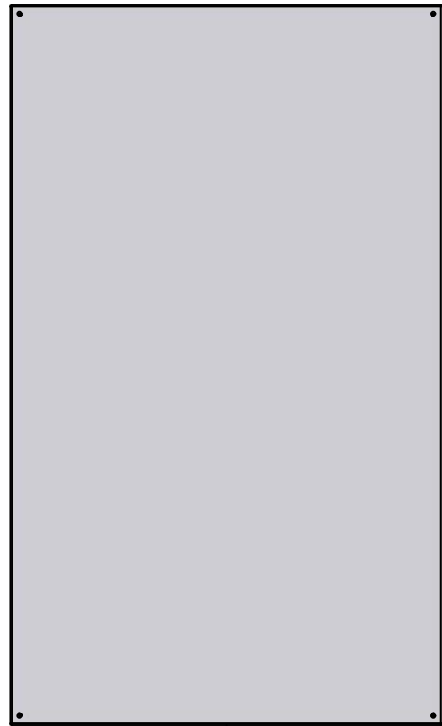

TOP



BACK

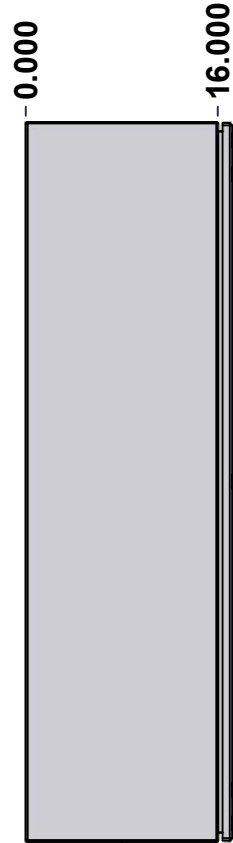

LEFT

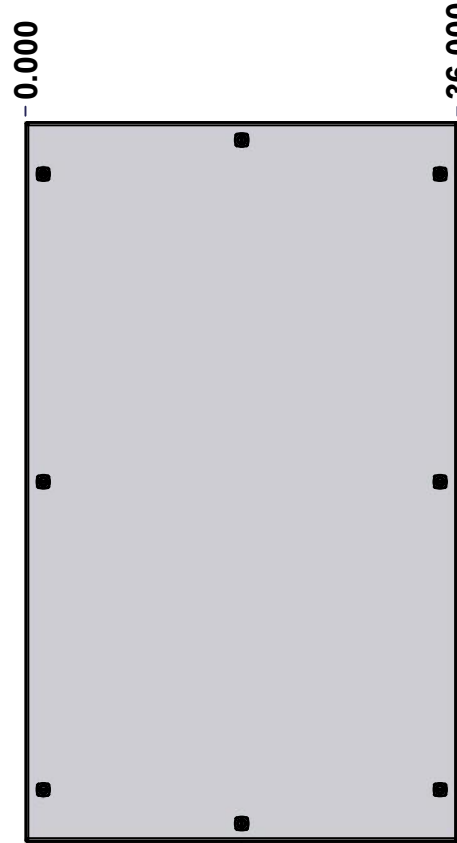

FRONT

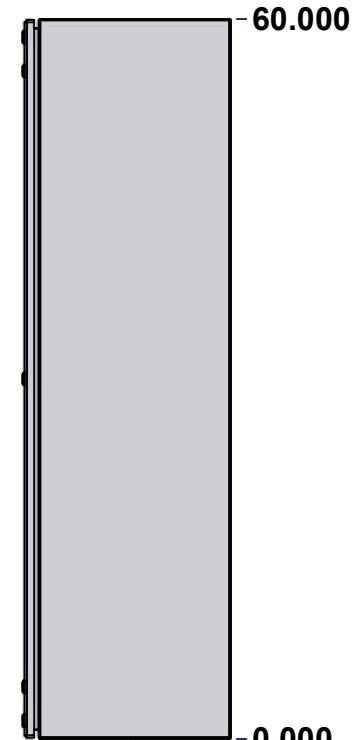

RIGHT

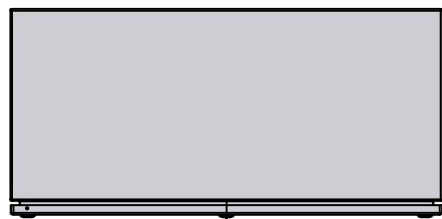

BOTTOM

No.	Revisions	Date	By/Par

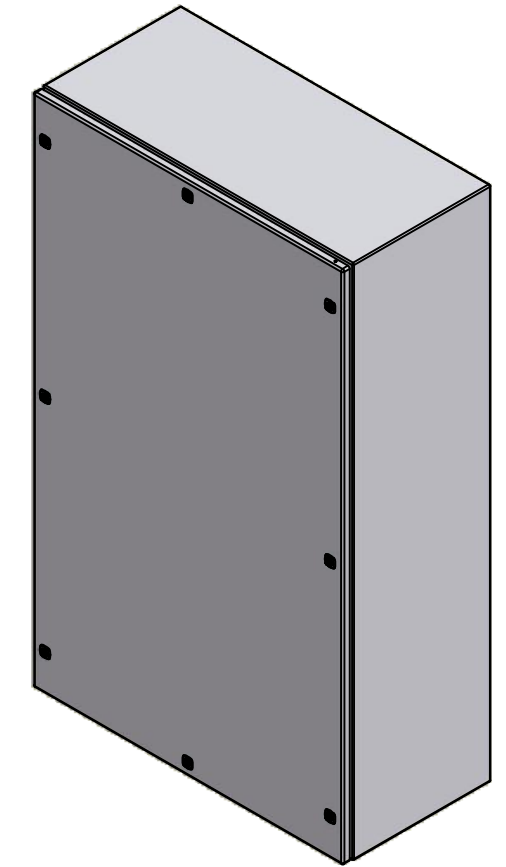

Isometric View

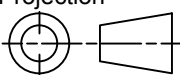

 Tél: (450) 979-4373 Fax: (450) 979-4626 www.exmweb.com		Flatness Aplatissement Max 3.0mm Projection 
Customer Client	Date	
Drawn By Dessiné Par	BoxCad: BoxCad	Date 18-Dec-14
Material Matière	Aluminum 5052-H32 (2.5mm)	
Color Couleur	Asa-61 Grey	Finish Fini Smooth
Description 5412EALQT 60" x 36" x 16" Assembly		Detail Rev.
Part Number Numéro Pièce	5412EALQT603616	Rev. 1 0

SEE BILL OF MATERIAL ON LAST PAGE

This drawing is confidential and must not be reproduced or used without the consent of EXM

Ce dessin est confidentiel et ne doit pas être reproduit ou utilisé sans le consentement de EXM

NOTE	
ITEM	DESCRIPTION
1	NEMA 4X Enclosure
2	C/W Standard ground studs on box and cover
3	C/W Standard door stiffener
4	C/W Standard inner panel (Included)
5	C/W Standard inner panel mounting studs
6	C/W 880 PP included (Not installed)

No.	Revisions	Date	By/Par

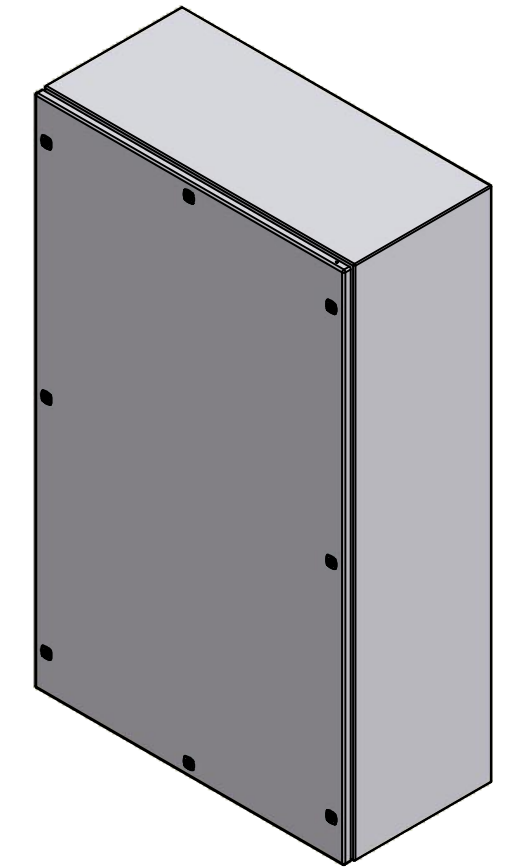

Isometric View



PACKING		
ITEM	QTY	DESCRIPTION
Cardboard sleeve	2	Top and Bottom
Cardboard strip	2	Between back of enclosure and inner panel
Plastic bag	1	To protect cover surface and inside gasket
Cardboard corner	4	To reinforced for the plastic strap tightening
Plastic strap - Black	2	To Squeeze the 2 cardboard sleeve together
Packaging label	3	White label with PN
Plastic strap- Green	2	To secure the enclosure to the wood pallet
Wood Pallet	1	2" deeper and 3" larger than enclosure size

2	STK-Q-07310	2	Flange Lock Nut M8
1	881 SP6036G	0	881 SP - Inner Panel
2	STK-Q-07615	0	Inner Panel Support Bracket
1	STK-K-01800	5	5412 ES Accessory Kit
3	STK-K-01320	0	5412 ES Inner Panel Accessory Kit
1	880 PP	6	Self Adhesive Print Pocket
1	5412EALQT603616C	0	5412EALQT 60" x 36" Cover
1	5412EALQT603616B	0	5412EALQT 60" x 36" x 16" Body
Qty	Part Number	Rev	Description
Parts List			

	Tél: (450) 979-4373 Fax: (450) 979-4626 www.exmweb.com	Flatness Aplatissement Max 3.0mm
	Projection 	Customer Client Date
Drawn By Dessiné Par BoxCad: BoxCad	Date 18-Dec-14	Material Matière Aluminum 5052-H32 (2.5mm)
Color Couleur Asa-61 Grey	Finish Fini Smooth	Description 5412EALQT 60" x 36" x 16" Assembly
Part Number Numéro Pièce 5412EALQT603616	Rev. 0	Detail Rev. 2 9

This drawing is confidential and must not be reproduced or used without the consent of EXM

Ce dessin est confidentiel et ne doit pas être reproduit ou utilisé sans le consentement de EXM

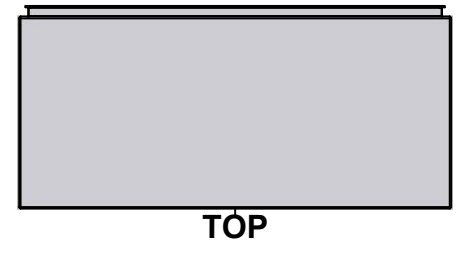

TOP

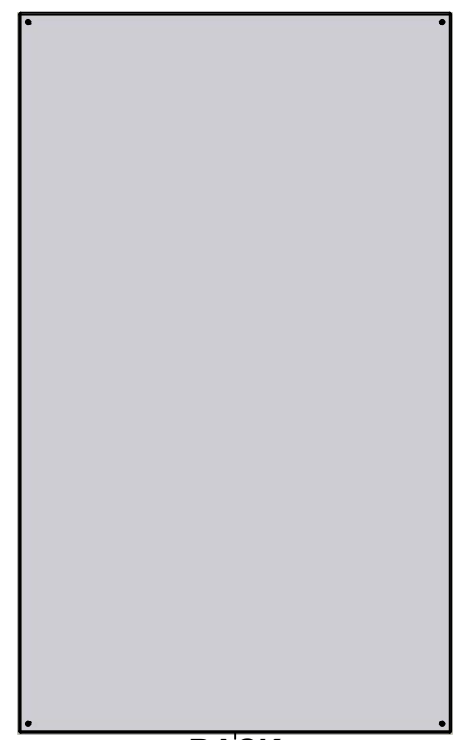

BACK



BOTTOM

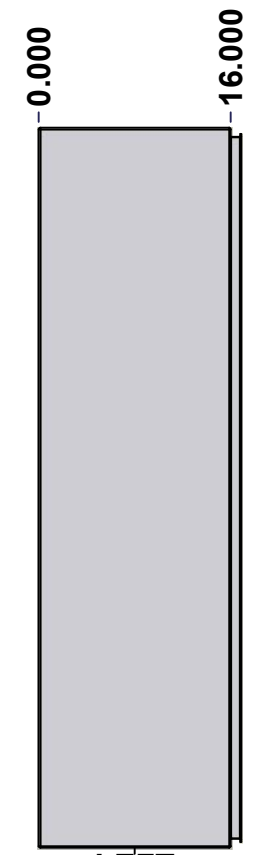

LEFT

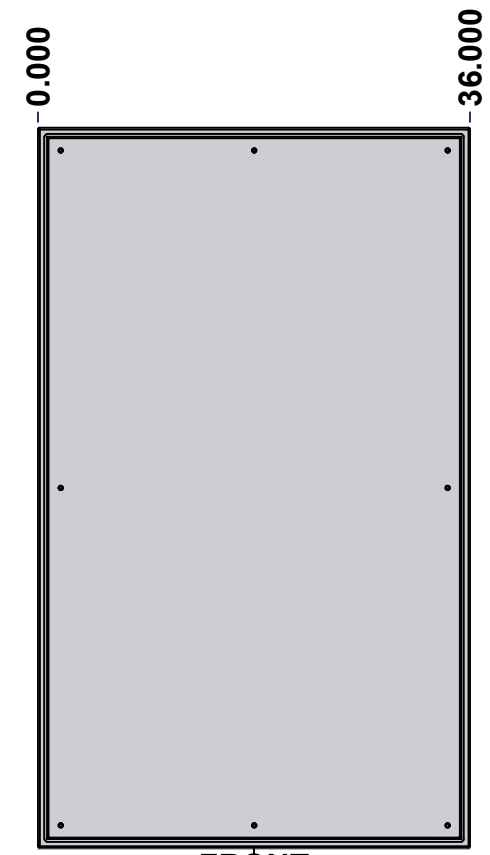

FRONT

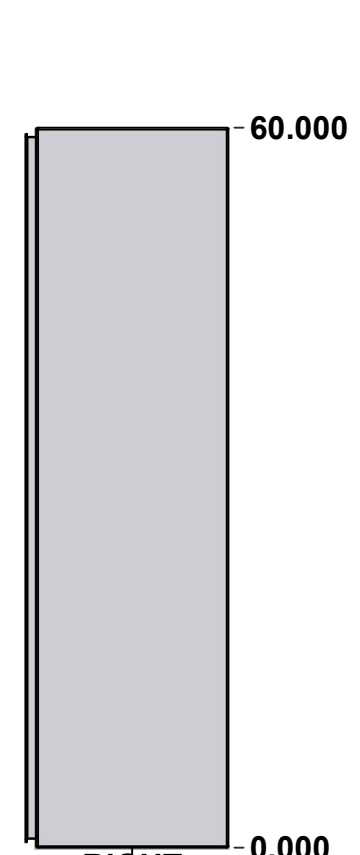

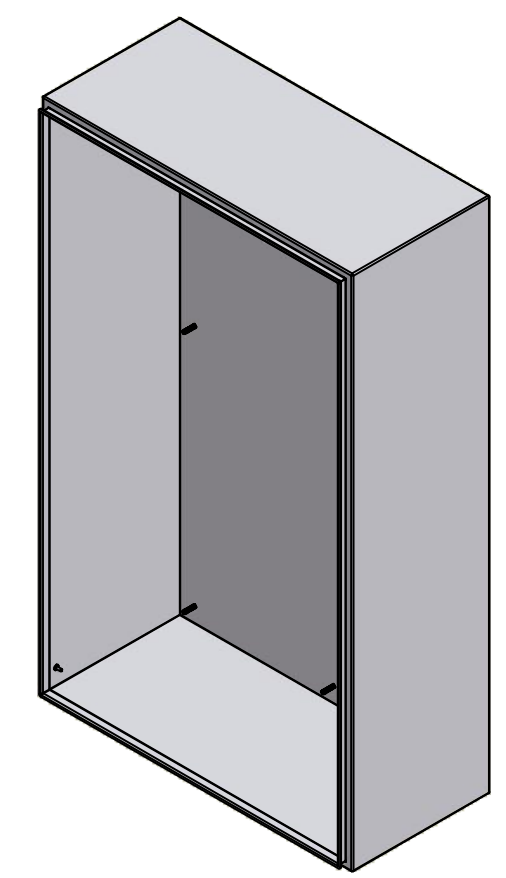

RIGHT

No.	Revisions	Date	By/Par

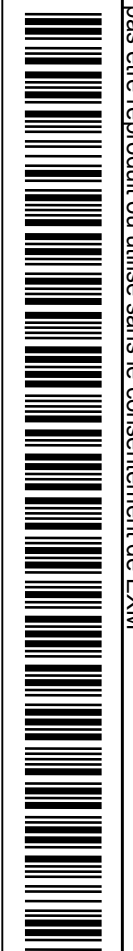

Isometric View

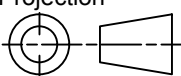

 Tél: (450) 979-4373 Fax: (450) 979-4626 www.exmweb.com		Flatness Aplatissement Max 3.0mm Projection 
Customer Client	Date	
Drawn By Dessiné Par	BoxCad: BoxCad	Date 18-Dec-14
Material Matière	Aluminum 5052-H32 (2.5mm)	
Color Couleur	Asa-61 Grey	Finish Fini Smooth
Description	Detail Rev.	
5412EALQT 60" x 36" x 16" Body		
Part Number Numéro Pièce	Rev.	3
5412EALQT603616B	0	9

SEE BILL OF MATERIAL ON LAST PAGE

This drawing is confidential and must not be reproduced or used without the consent of EXM

Ce dessin est confidentiel et ne doit pas être reproduit ou utilisé sans le consentement de EXM

STANDARD FEATURES ARE NOT LISTED IN THIS HOLE TABLE			
HOLE TABLE - LEFT VIEW (CUSTOM FEATURE ONLY)			
CUT-OUT	XDIM	YDIM	DESCRIPTION
1	14.500	2.000	GND STUD M6 x 16mm (Inside)

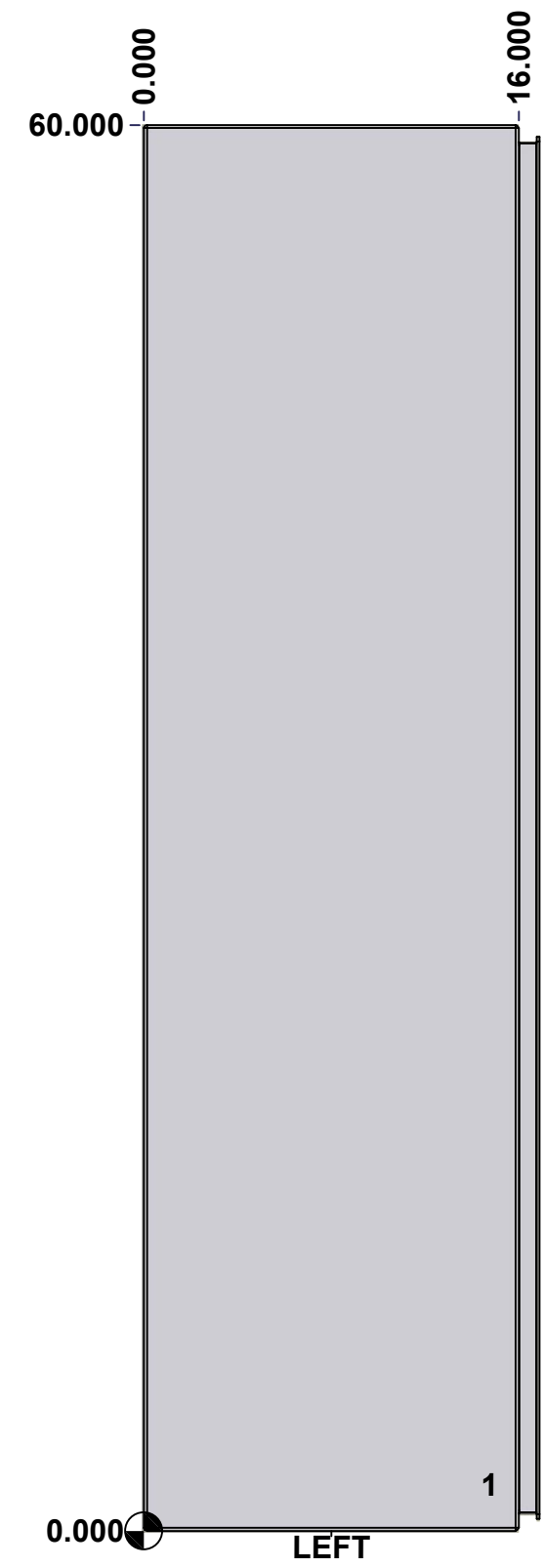

	Description	Status	
	5412EALQT 60" x 36" x 16" Body	(NULL)	
	Part Number Numéro Pièce	Rev.	
	5412EALQT603616B	0	4 9

This drawing is confidential and must not be reproduced or used without the consent of EXM

Ce dessin est confidentiel et ne doit pas être reproduit ou utilisé sans le consentement de EXM

STANDARD FEATURES ARE NOT LISTED IN THIS HOLE TABLE

HOLE TABLE - BACK VIEW (CUSTOM FEATURE ONLY)

CUT-OUT	XDIM	YDIM	DESCRIPTION
1	1.875	1.875	IP STUD M8 x 35mm (Inside)
2	1.875	58.125	IP STUD M8 x 35mm (Inside)
3	34.125	58.125	IP STUD M8 x 35mm (Inside)
4	34.125	1.875	IP STUD M8 x 35mm (Inside)
5	1.875	30.000	IP STUD M8 x 35mm (Inside)
6	34.125	30.000	IP STUD M8 x 35mm (Inside)
7	18.000	1.875	IP STUD M8 x 35mm (Inside)
8	18.000	58.125	IP STUD M8 x 35mm (Inside)

9	35.250	0.750	RND Ø0.390
10	35.250	59.250	RND Ø0.390
11	0.750	59.250	RND Ø0.390
12	0.750	0.750	RND Ø0.390

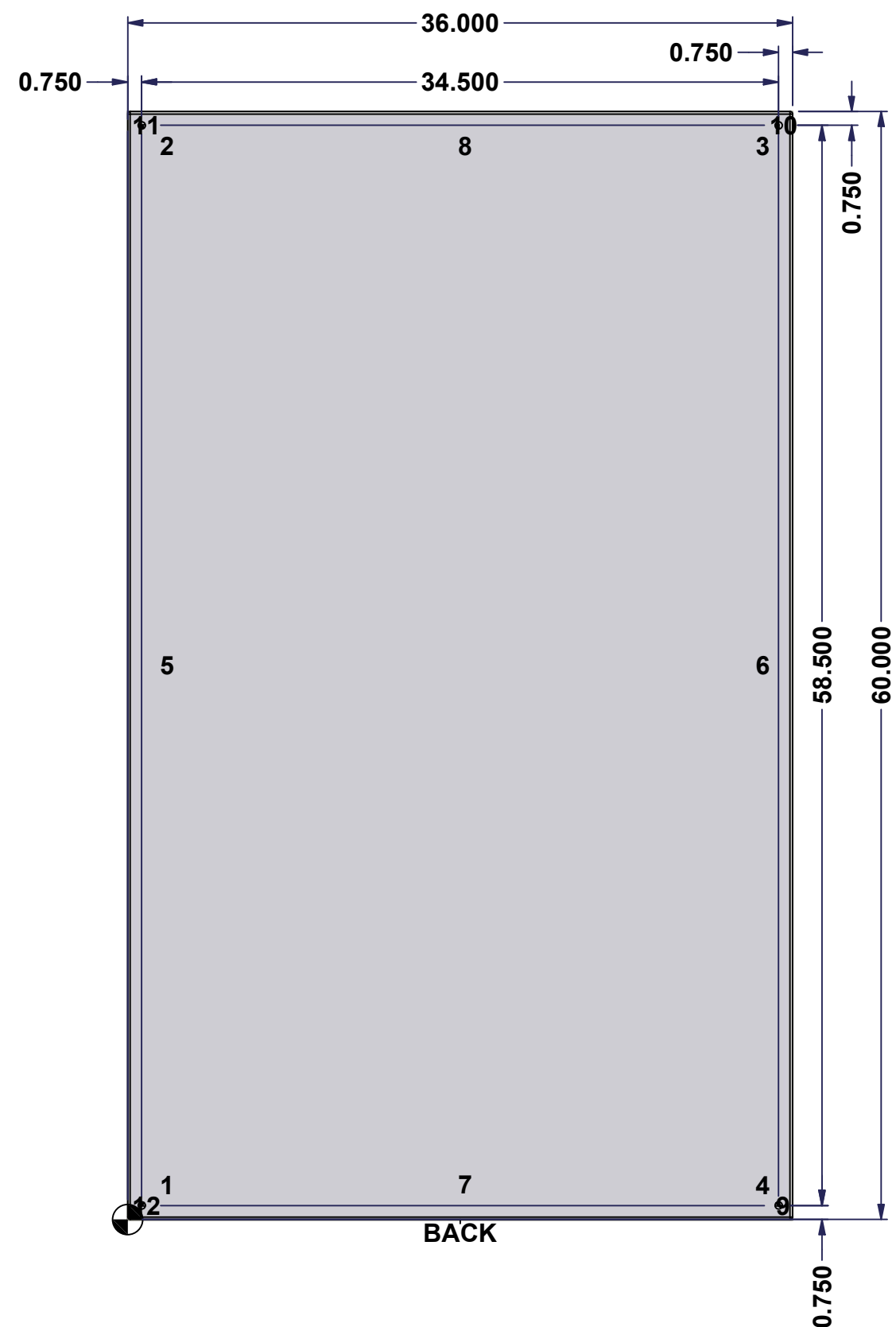

BACK

	Description	Status	
	5412EALQT 60" x 36" x 16" Body	(NULL)	
	Part Number Numéro Pièce	Rev.	
	5412EALQT603616B	0	5 9

This drawing is confidential and must not be reproduced or used without the consent of EXM

Ce dessin est confidentiel et ne doit pas être reproduit ou utilisé sans le consentement de EXM

No.	Revisions	Date	By/Par

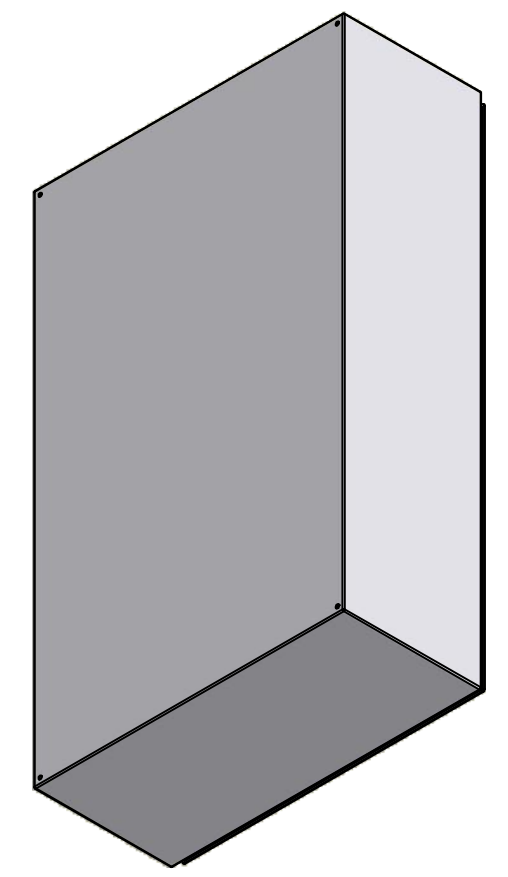

Isometric View

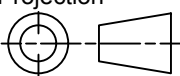

 Tél: (450) 979-4373 Fax: (450) 979-4626 www.exmweb.com	Flatness Aplatissement	Max 3.0mm
	Projection	
Customer Client	Date	
Drawn By Dessiné Par	BoxCad: BoxCad	Date 18-Dec-14
Material Matière	Aluminum 5052-H32 (2.5mm)	
Color Couleur	Asa-61 Grey	Finish Fini Smooth
Description	Detail Rev.	
5412EALQT 60" x 36" x 16" Body		
Part Number Numéro Pièce	Rev.	6
5412EALQT603616B	0	9

Qty	Part Number	Rev	Description
1	STK-Q-16090	0	Ground Stud M6 x 16mm Aluminum
1	STK-P-02400S	0	Powder Paint (Asa-61 Grey / Smooth)
8	STK-Q-16010	0	Stud M8 x 35mm Aluminum
1	5412EALQT603616B-P	0	5412EALQT 60" x 36" x 16" Body Part
Parts List			

This drawing is confidential and must not be reproduced or used without the consent of EXM

Ce dessin est confidentiel et ne doit pas être reproduit ou utilisé sans le consentement de EXM

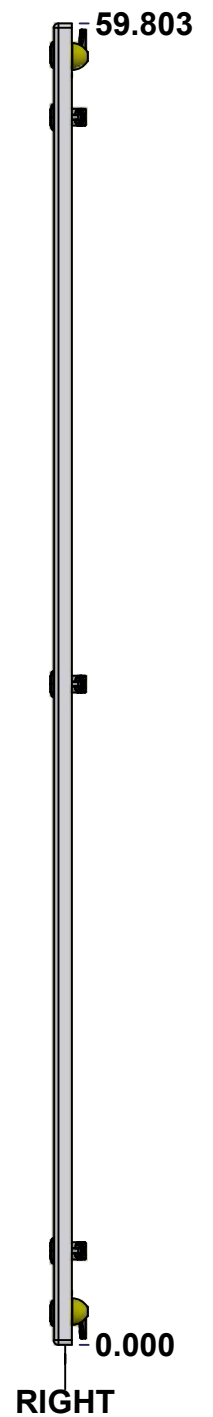
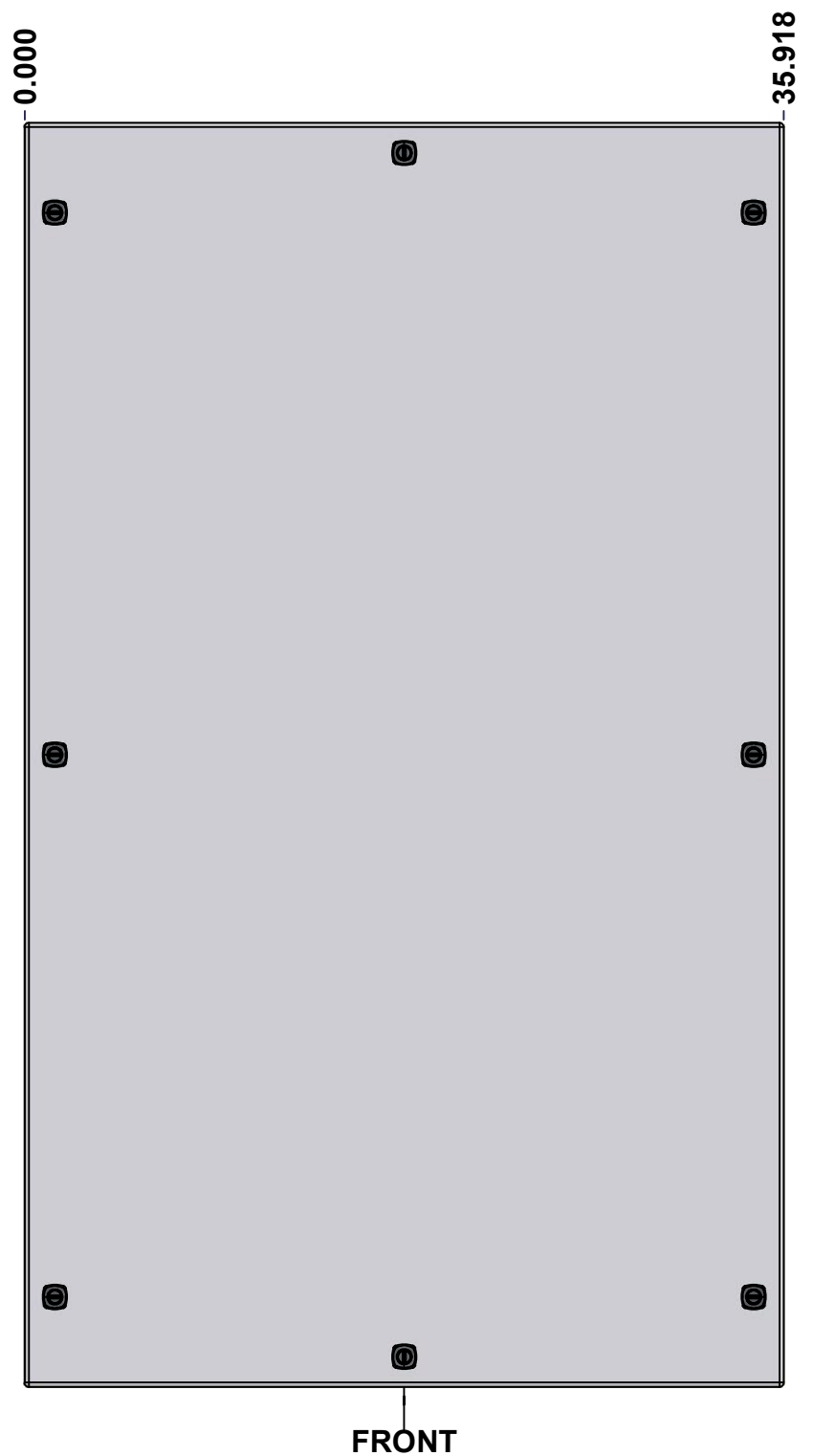
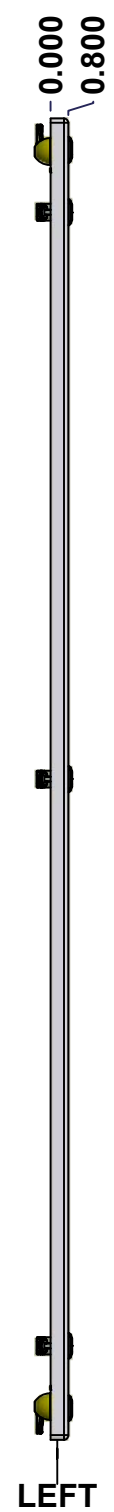
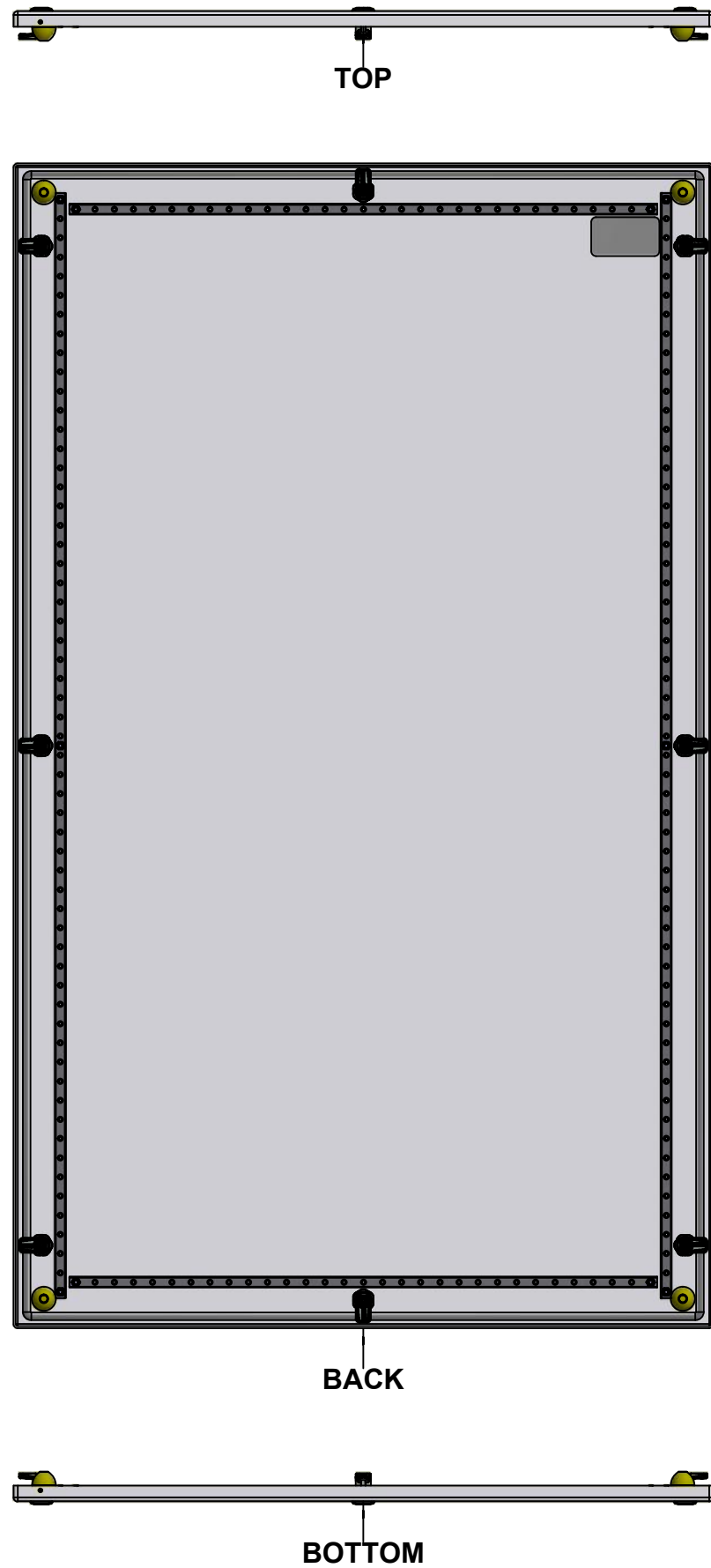

No.	Revisions	Date	By/Par

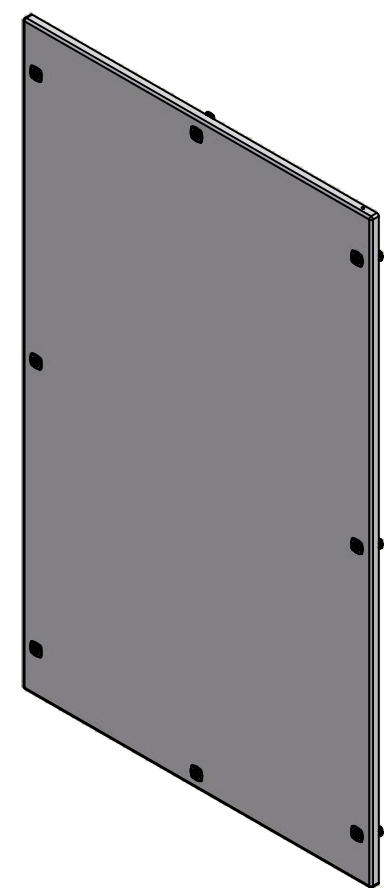

Isometric View

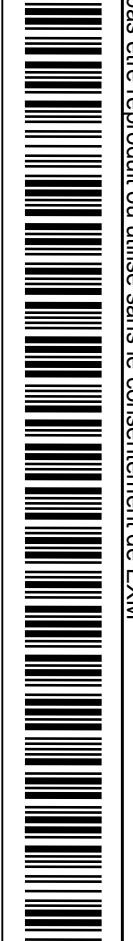

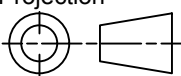
 Tél: (450) 979-4373 Fax: (450) 979-4626 www.exmweb.com		Flatness Aplatissement Max 3.0mm Projection 
Customer Client	Date	
Drawn By Dessiné Par	BoxCad: BoxCad	Date 18-Dec-14
Material Matière	Aluminum 5052-H32 (2.5mm)	
Color Couleur	Asa-61 Grey	Finish Fini Smooth
Description 5412EALQT 60" x 36" Cover		Detail Rev.
Part Number Numéro Pièce	Rev. 0	7 9

SEE BILL OF MATERIAL ON LAST PAGE

5412EALQT603616C

This drawing is confidential and must not be reproduced or used without the consent of EXM

Ce dessin est confidentiel et ne doit pas être reproduit ou utilisé sans le consentement de EXM

STANDARD FEATURES ARE NOT LISTED IN THIS HOLE TABLE

HOLE TABLE - FRONT VIEW (CUSTOM FEATURE ONLY)

CUT-OUT	XDIM	YDIM	DESCRIPTION
1	2.401	1.850	STUD M6 x 18mm (Inside)
2	2.401	57.953	STUD M6 x 18mm (Inside)
3	33.517	57.953	STUD M6 x 18mm (Inside)
4	33.517	1.850	STUD M6 x 18mm (Inside)
5	2.401	29.902	STUD M6 x 18mm (Inside)
6	33.517	29.902	STUD M6 x 18mm (Inside)
7	3.195	2.350	STUD M6 x 18mm (Inside)
8	3.195	57.453	STUD M6 x 18mm (Inside)
9	32.723	57.453	STUD M6 x 18mm (Inside)
10	32.723	2.350	STUD M6 x 18mm (Inside)
11	1.550	1.500	STUD M6 x 18mm (Inside)
12	34.368	1.500	STUD M6 x 18mm (Inside)
13	1.550	58.303	STUD M6 x 18mm (Inside)
14	34.368	58.303	STUD M6 x 18mm (Inside)

15	4.500	56.053	LABEL_EXM (Inside)
16	1.424	55.553	LOCK 880 SCQ4-SL @ 180.0°
17	1.424	29.902	LOCK 880 SCQ4-SL @ 180.0°
18	1.424	4.250	LOCK 880 SCQ4-SL @ 180.0°
19	34.494	55.553	LOCK 880 SCQ4-SL @ 0.0°
20	34.494	29.902	LOCK 880 SCQ4-SL @ 0.0°
21	34.494	4.250	LOCK 880 SCQ4-SL @ 0.0°
22	17.959	58.379	LOCK 880 SCQ4-SL @ 90.0°
23	17.959	1.424	LOCK 880 SCQ4-SL @ 270.0°

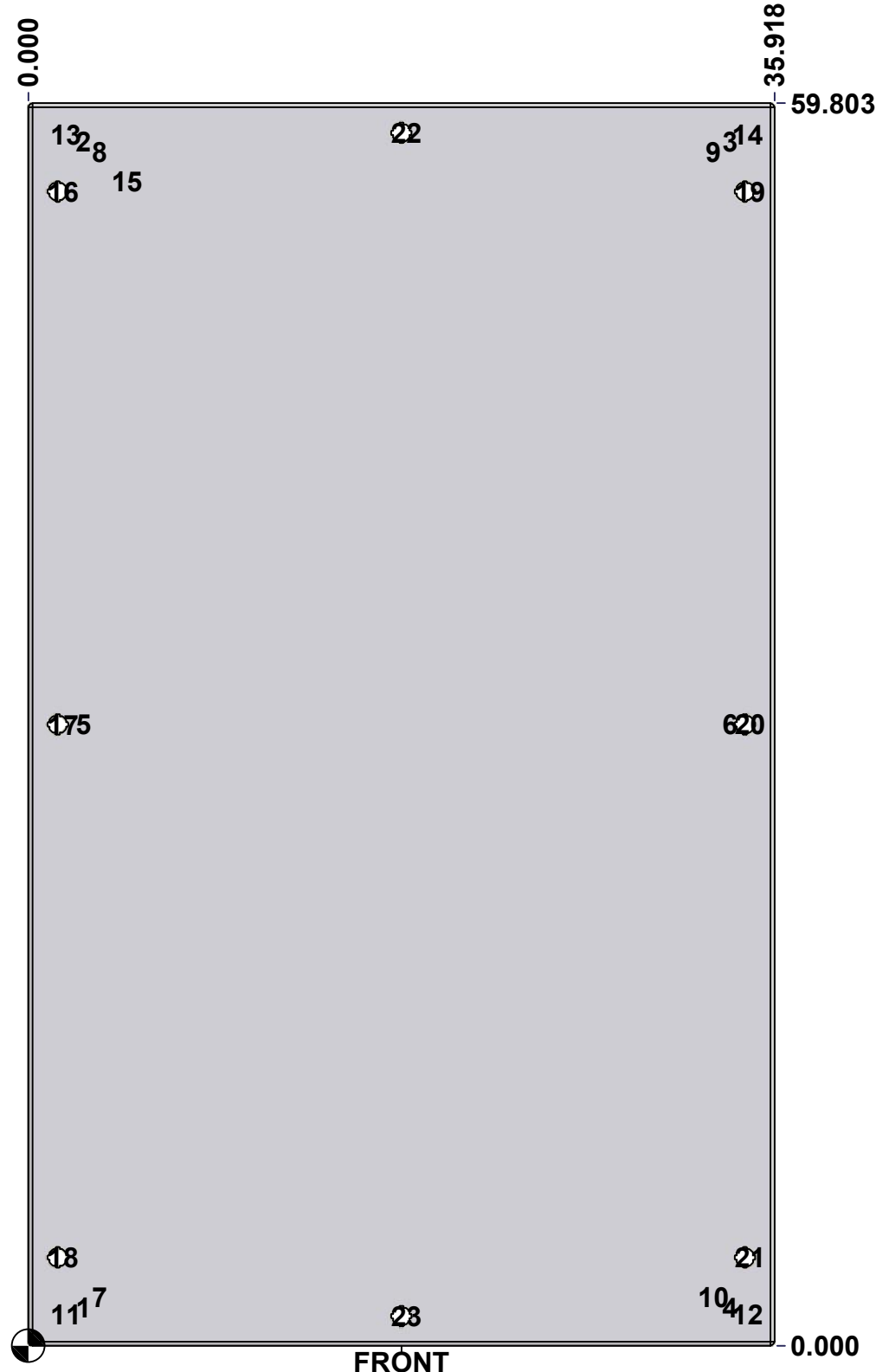

	Description	Status
	5412EALQT 60" x 36" Cover	(NULL)
Part Number Numéro Pièce 5412EALQT603616C	Rev.	8
	0	9

This drawing is confidential and must not be reproduced or used without the consent of EXM

Ce dessin est confidentiel et ne doit pas être reproduit ou utilisé sans le consentement de EXM

No.	Revisions	Date	By/Par

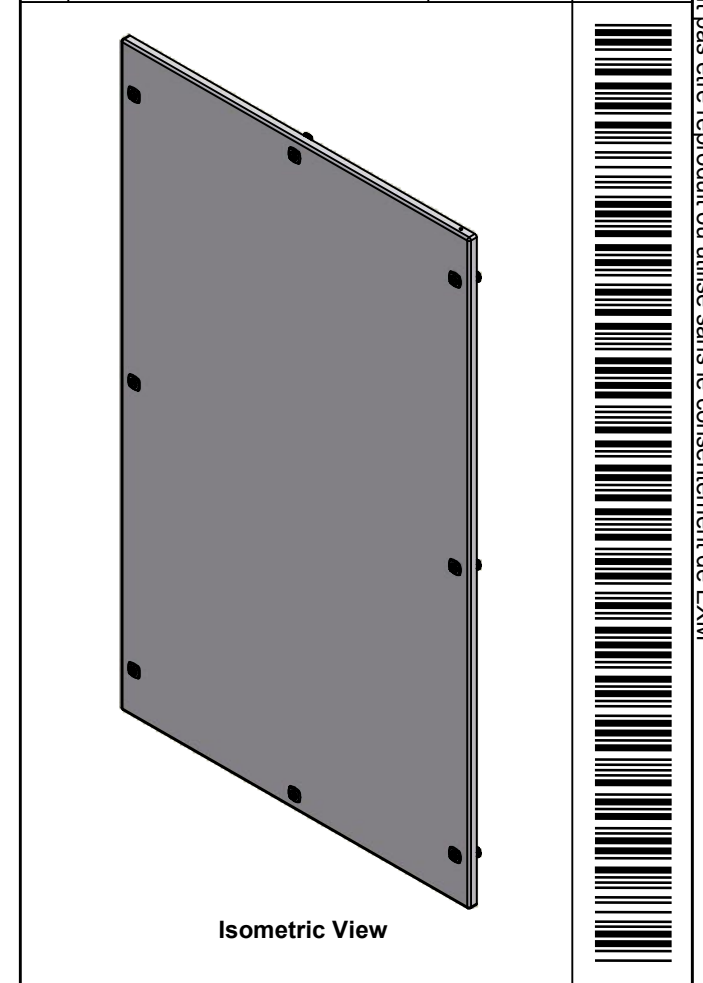

 Tél: (450) 979-4373
 Fax: (450) 979-4626
www.exmweb.com

Flatness / Aplatissement: Max 3.0mm
 Projection: 

Qty	Part Name	Rev	Description
1	STK-S-00100	0	3.5" x 2" Silver Milar Flexcon Sticker
1	STK-P-02400S	0	Powder Paint (Asa-61 Grey / Smooth)
2	STK-Q-46020-60	5	5412 ES Vertical Door Stiffener 60"
14	STK-Q-16060	0	Stud M6 x 18mm Aluminum
2	STK-Q-46025-36-3	0.1.1	5412 ES Horizontal Door Stiffener 36" (3 Pts)
1	5412EALQT603616G	0	5412EALQT 60" x 36" Cover Gasket Part
1	5412EALQT603616C-P	0	5412EALQT 60" x 36" Cover Part
8	880 SCQ4-SL	6	5412 ES 1/4 Turn Lock
10	STK-Q-07220	1	M6 Nylon Insert Lock Nut
4	STK-Q-46515	3	5412 ES Door Support with Brass Insert
Parts List			

Customer / Client	Date
Drawn By / Dessiné Par: BoxCad: BoxCad	Date: 18-Dec-14
Material / Matière: Aluminum 5052-H32 (2.5mm)	
Color / Couleur: Asa-61 Grey	Finish / Fini: Smooth
Description: 5412EALQT 60" x 36" Cover	Detail Rev.
Part Number / Numéro Pièce: 5412EALQT603616C	Rev. 0 / 9

This drawing is confidential and must not be reproduced or used without the consent of EXM

Ce dessin est confidentiel et ne doit pas être reproduit ou utilisé sans le consentement de EXM



TOP

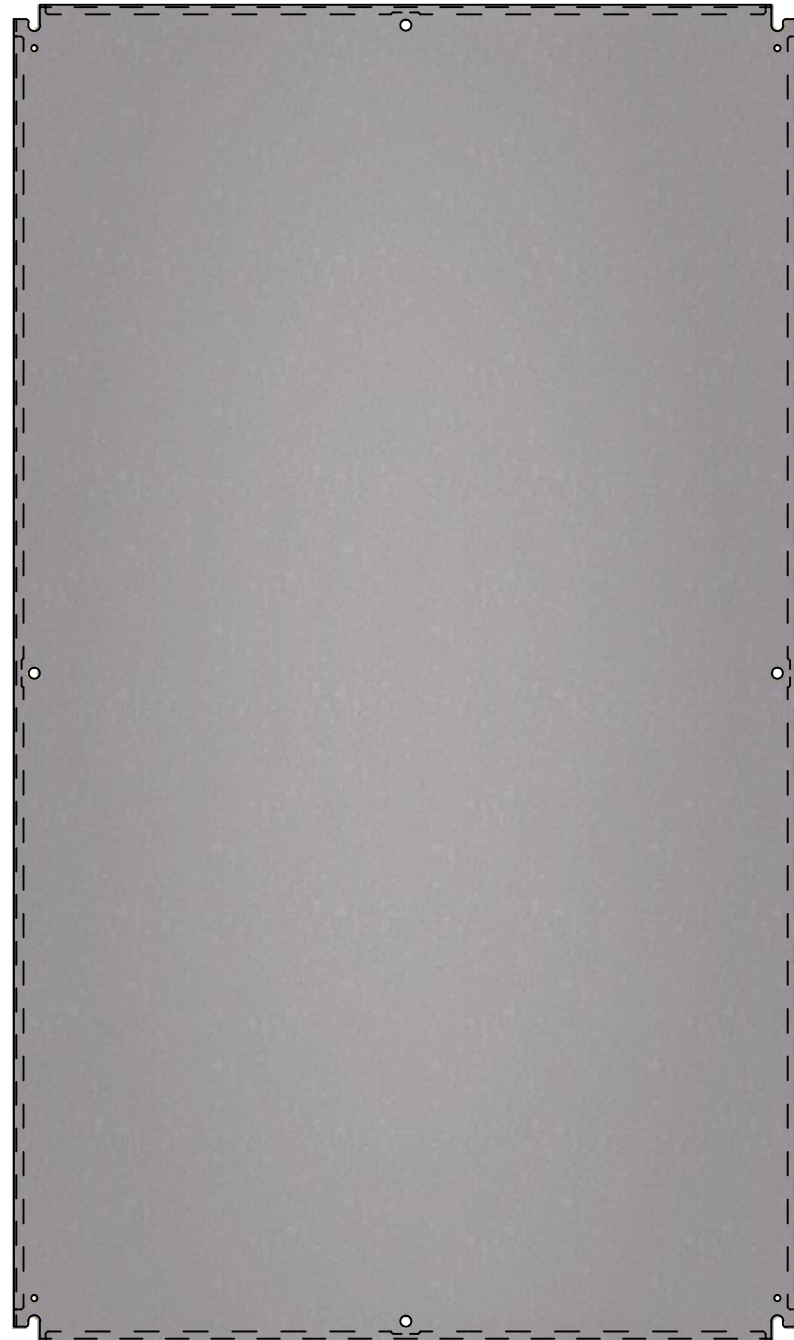

FRONT

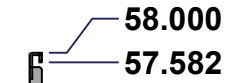

RIGHT

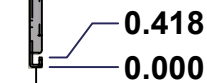

No.	Revisions	Date	By/Par

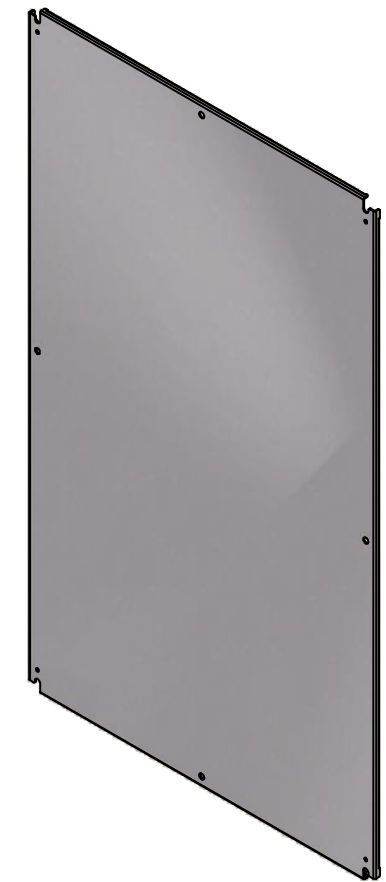

Isometric View



Tél: (450) 979-4373 Fax: (450) 979-4626 www.exmweb.com	Flatness Aplatissement Max 3.0mm
	Projection
Customer Client	Date
Drawn By / Dessiné Par: BoxCad	Date: 23-Jan-07
Material / Matière: See Part List	
Color / Couleur: See Part List	Finish / Fini: See Part List
Description: 881 SP - Inner Panel	Detail Rev.
Part Number / Numéro Pièce: 881 SP6036G	Rev. 0

Qty	Part Number	Rev	Description	Material	Color	Finish
1	881 SP6036G-P	0	881 SP - Inner Panel Part	12 Ga Galvanized	Unpainted	Galvanized

Parts List

This drawing is confidential and must not be reproduced or used without the consent of EXM

Ce dessin est confidentiel et ne doit pas être reproduit ou utilisé sans le consentement de EXM

Table 1			FRONT VIEW
CUT-OUT	XDIM	YDIM	DESCRIPTION
1	17.000	0.875	MTG STUD HOLE (RND Ø0.500)
2	0.875	29.000	MTG STUD HOLE (RND Ø0.500)
3	33.125	29.000	MTG STUD HOLE (RND Ø0.500)
4	17.000	57.125	MTG STUD HOLE (RND Ø0.500)
5	0.875	1.875	GROUND HOLE (RND Ø0.290)
6	33.125	1.875	GROUND HOLE (RND Ø0.290)
7	0.875	56.125	GROUND HOLE (RND Ø0.290)
8	33.125	56.125	GROUND HOLE (RND Ø0.290)

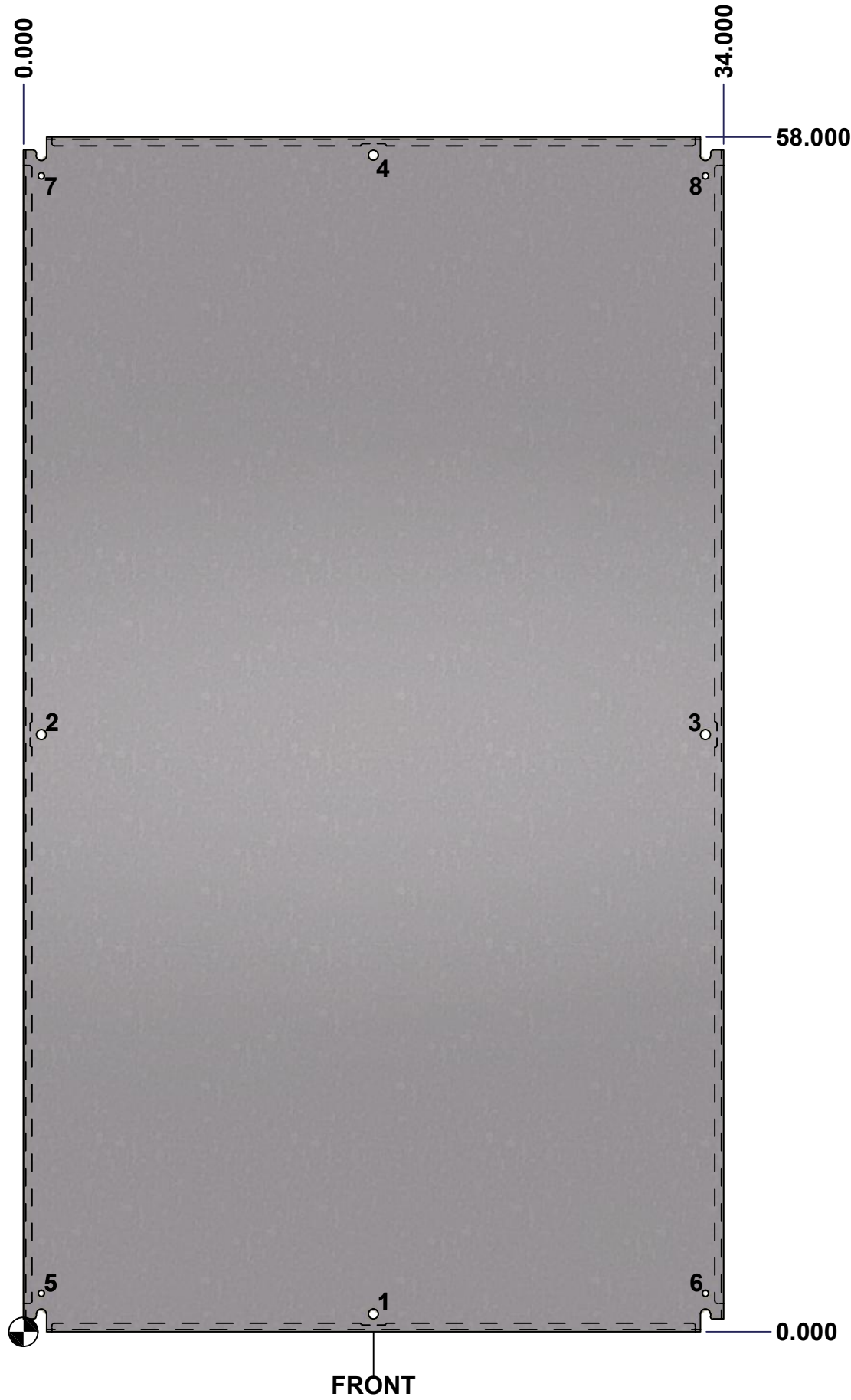

All knockouts are actual size / Les disques défonçables sont grandeur réel

No.	Revisions	Date	By/Par



Isometric View



	Tél: (450) 979-4373 Fax: (450) 979-4626 www.exmweb.com	Flatness Aplatissement Max 3.0mm
		Projection
Customer Client		Date
Drawn By Dessiné Par	BoxCad	Date 23-Jan-07
Material Matière	See Part List	
Color Couleur	See Part List	Finish Fini See Part List
Description	881 SP - Inner Panel	
Part Number Numéro Pièce	881 SP6036G	Detail Rev.
	Rev. 0	2 / 2