

This drawing is confidential and must not be reproduced or used without the consent of EXM

Ce dessin est confidentiel et ne doit pas être reproduit ou utilisé sans le consentement de EXM

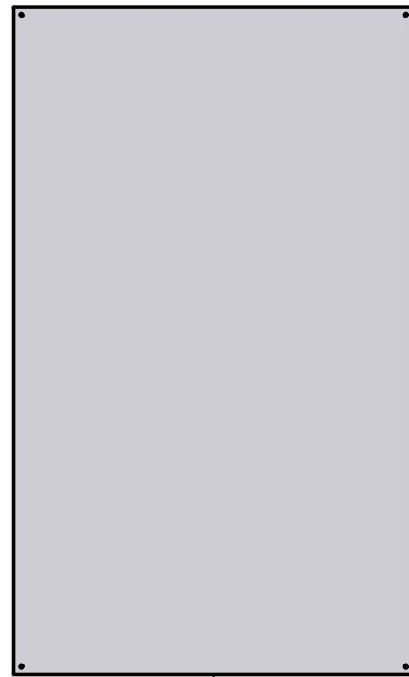

TOP



BACK



BOTTOM

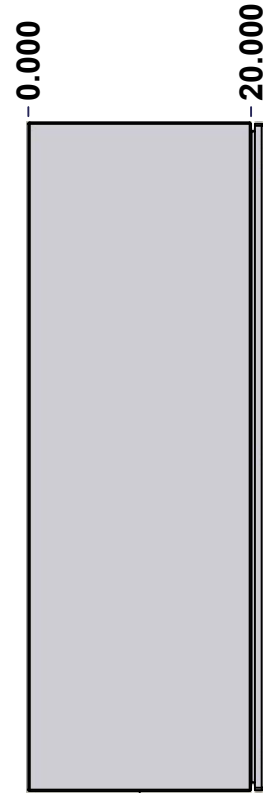

LEFT

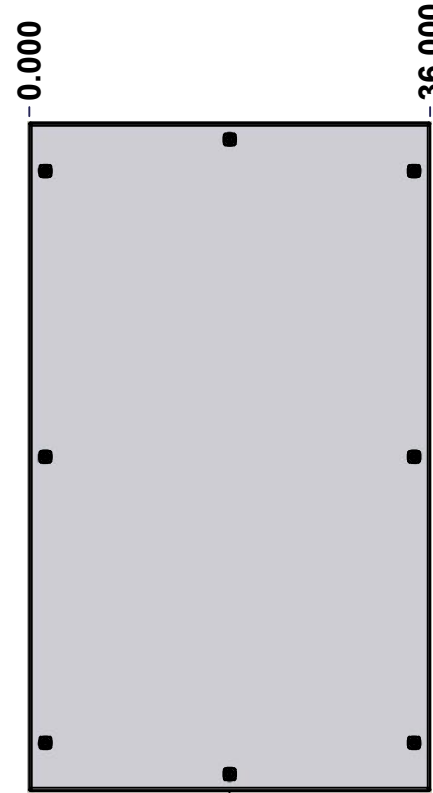

FRONT

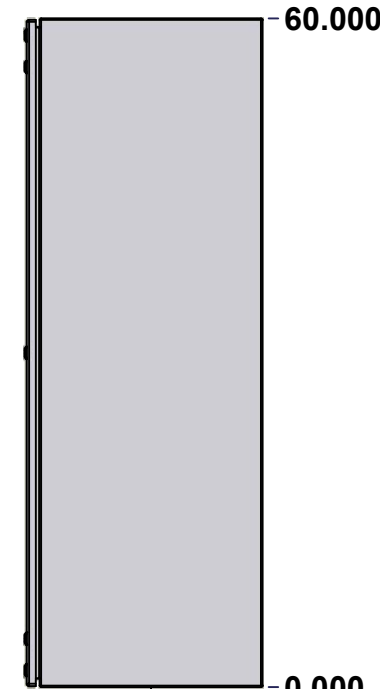

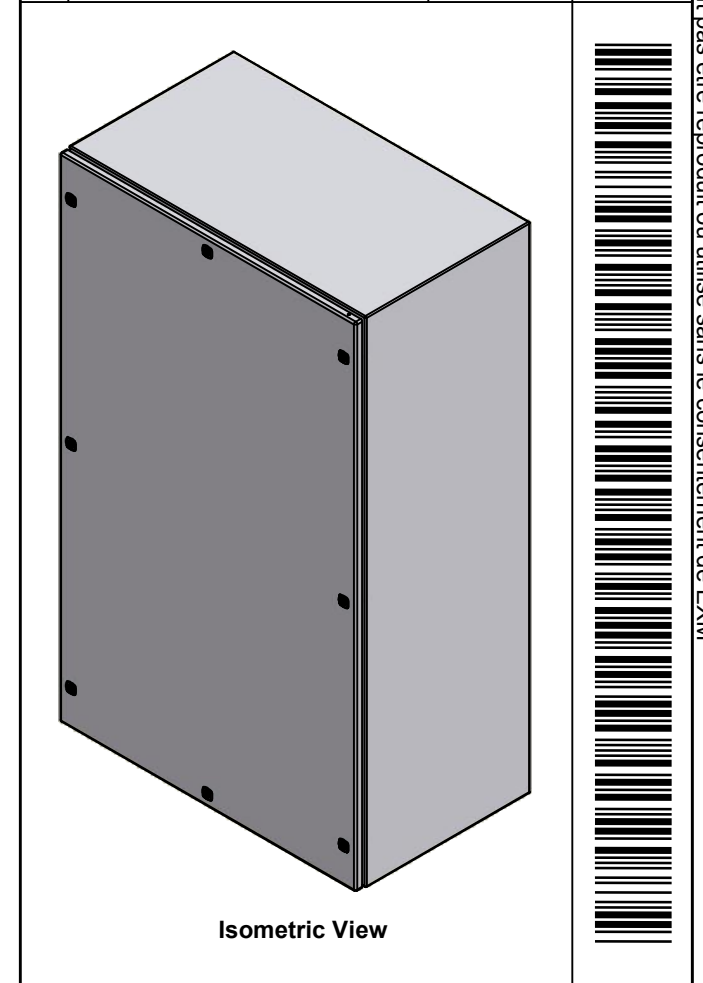

RIGHT

| No. | Revisions | Date | By/Par |
|-----|-----------|------|--------|
|     |           |      |        |
|     |           |      |        |
|     |           |      |        |
|     |           |      |        |
|     |           |      |        |

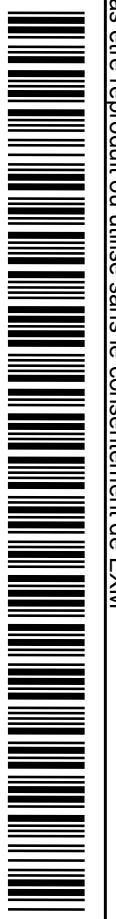

Isometric View

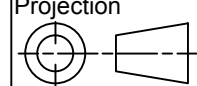

|  |                           |   |
|--|---------------------------|---|
|  Tél: (450) 979-4373<br>Fax: (450) 979-4626<br><a href="http://www.exmweb.com">www.exmweb.com</a> |                           | Flatness<br>Aplatissement<br>Max 3.0mm<br>Projection<br> |
| Customer<br>Client   | Date                      |   |
| Drawn By<br>Dessiné Par  | BoxCad: BoxCad            | Date 18-Dec-14  |
| Material<br>Matière  | Aluminum 5052-H32 (2.5mm) |   |
| Color<br>Couleur   | Asa-61 Grey               | Finish<br>Fini Smooth   |
| Description  | Detail Rev.               |   |
| 5412EALQT 60" x 36" x 20" Assembly   |                           |   |
| Part Number<br>Numéro Pièce  | Rev.                      | 1   |
| 5412EALQT603620  | 0                         | 9   |

SEE BILL OF MATERIAL ON LAST PAGE

This drawing is confidential and must not be reproduced or used without the consent of EXM

Ce dessin est confidentiel et ne doit pas être reproduit ou utilisé sans le consentement de EXM

| NOTE |  |
|------|--|
| ITEM | DESCRIPTION                                |
| 1    | NEMA 4X Enclosure                          |
| 2    | C/W Standard ground studs on box and cover |
| 3    | C/W Standard door stiffener                |
| 4    | C/W Standard inner panel (Included)        |
| 5    | C/W Standard inner panel mounting studs    |
| 6    | C/W 880 PP included (Not installed)        |

| No. | Revisions | Date | By/Par |
|-----|-----------|------|--------|
|     |           |      |        |
|     |           |      |        |
|     |           |      |        |
|     |           |      |        |
|     |           |      |        |
|     |           |      |        |

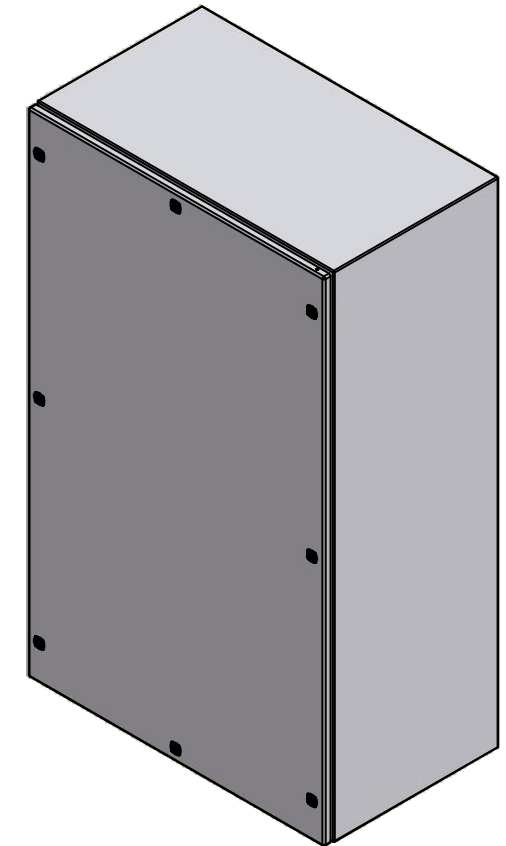

Isometric View



 Tél: (450) 979-4373  
 Fax: (450) 979-4626  
[www.exmweb.com](http://www.exmweb.com)

Flatness  
 Aplatissement  
 Max 3.0mm  
 Projection  

|  |                 |
|--|-----------------|
| Customer Client                        | Date            |
| Drawn By / Dessiné Par: BoxCad: BoxCad | Date: 18-Dec-14 |

Material Matière: Aluminum 5052-H32 (2.5mm)

Color Couleur: Asa-61 Grey      Finish Fini: Smooth

Description: 5412EALQT 60" x 36" x 20" Assembly      Detail Rev.

Part Number Numéro Pièce: **5412EALQT603620**      Rev. 0      2/9

| PACKING               |     |  |
|-----------------------|-----|--|
| ITEM                  | QTY | DESCRIPTION                                    |
| Cardboard sleeve      | 2   | Top and Bottom                                 |
| Cardboard strip       | 2   | Between back of enclosure and inner panel      |
| Plastic bag           | 1   | To protect cover surface and inside gasket     |
| Cardboard corner      | 4   | To reinforced for the plastic strap tightening |
| Plastic strap - Black | 2   | To Squeeze the 2 cardboard sleeve together     |
| Packaging label       | 3   | White label with PN                            |
| Plastic strap- Green  | 2   | To secure the enclosure to the wood pallet     |
| Wood Pallet           | 1   | 2" deeper and 3" larger than enclosure size    |

| Qty | Part Number      | Rev | Description                       |
|-----|------------------|-----|-----------------------------------|
| 2   | STK-Q-07310      | 2   | Flange Lock Nut M8                |
| 1   | 881 SP6036G      | 0   | 881 SP - Inner Panel              |
| 2   | STK-Q-07615      | 0   | Inner Panel Support Bracket       |
| 1   | STK-K-01800      | 5   | 5412 ES Accessory Kit             |
| 3   | STK-K-01320      | 0   | 5412 ES Inner Panel Accessory Kit |
| 1   | 880 PP           | 6   | Self Adhesive Print Pocket        |
| 1   | 5412EALQT603620C | 0   | 5412EALQT 60" x 36" Cover         |
| 1   | 5412EALQT603620B | 0   | 5412EALQT 60" x 36" x 20" Body    |

Parts List

This drawing is confidential and must not be reproduced or used without the consent of EXM

Ce dessin est confidentiel et ne doit pas être reproduit ou utilisé sans le consentement de EXM



TOP



BACK

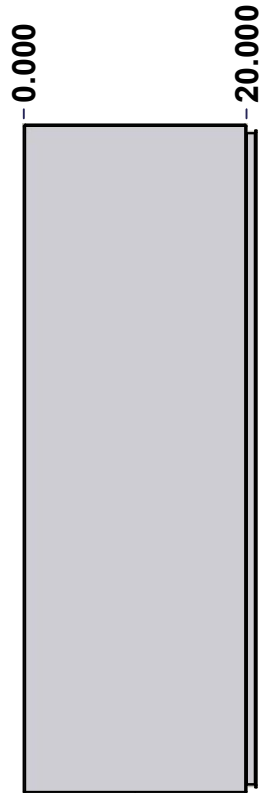

LEFT

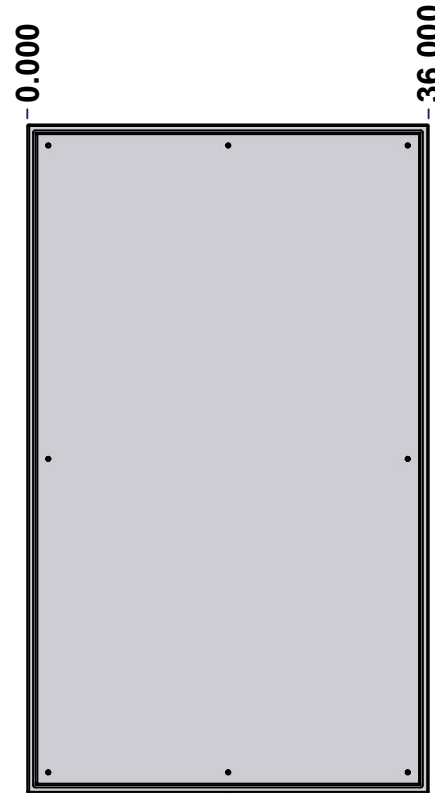

FRONT

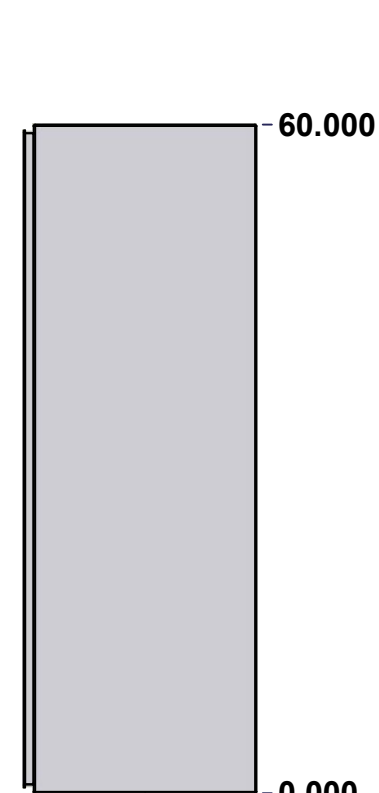

RIGHT



BOTTOM

| No. | Revisions | Date | By/Par |
|-----|-----------|------|--------|
|     |           |      |        |
|     |           |      |        |
|     |           |      |        |
|     |           |      |        |
|     |           |      |        |

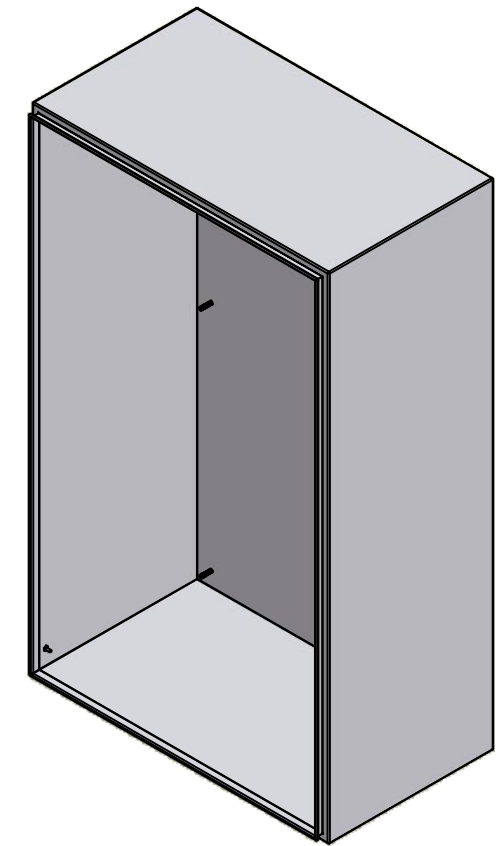

Isometric View



Tél: (450) 979-4373  
 Fax: (450) 979-4626  
[www.exmweb.com](http://www.exmweb.com)

Flatness  
Aplatissement

Max 3.0mm

Projection

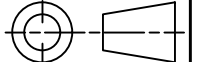

|   |                       |
|---|-----------------------|
| Customer Client                                     | Date                  |
| Drawn By<br>Dessiné Par BoxCad: BoxCad              | Date 18-Dec-14        |
| Material<br>Matière Aluminum 5052-H32 (2.5mm)       |                       |
| Color<br>Couleur Asa-61 Grey                        | Finish<br>Fini Smooth |
| Description<br>5412EALQT 60" x 36" x 20" Body       | Detail Rev.           |
| Part Number<br>Numéro Pièce <b>5412EALQT603620B</b> | Rev. 3<br><b>0</b>    |

SEE BILL OF MATERIAL ON LAST PAGE

This drawing is confidential and must not be reproduced or used without the consent of EXM

Ce dessin est confidentiel et ne doit pas être reproduit ou utilisé sans le consentement de EXM

| STANDARD FEATURES ARE NOT LISTED IN THIS HOLE TABLE |        |       |                             |
|---|--------|-------|-----------------------------|
| HOLE TABLE - LEFT VIEW (CUSTOM FEATURE ONLY)        |        |       |                             |
| CUT-OUT   | XDIM   | YDIM  | DESCRIPTION                 |
| 1   | 18.500 | 2.000 | GND STUD M6 x 16mm (Inside) |

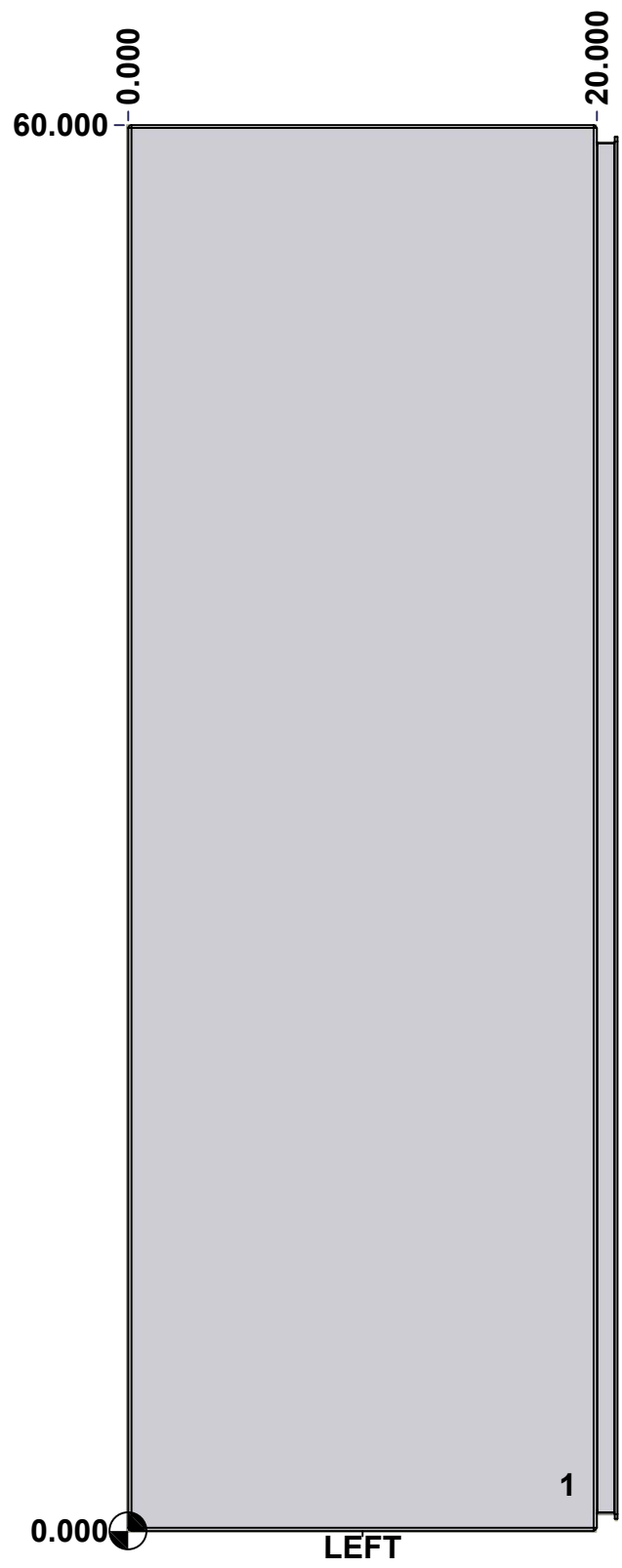

|  |                                |          |     |
|--|--------------------------------|----------|-----|
|  | Description                    | Status   |     |
|  | 5412EALQT 60" x 36" x 20" Body | (NULL)   |     |
|  | Part Number<br>Numéro Pièce    | Rev.     |     |
|  | <b>5412EALQT603620B</b>        | <b>0</b> | 4/9 |

This drawing is confidential and must not be reproduced or used without the consent of EXM

Ce dessin est confidentiel et ne doit pas être reproduit ou utilisé sans le consentement de EXM

**STANDARD FEATURES ARE NOT LISTED IN THIS HOLE TABLE**

**HOLE TABLE - BACK VIEW (CUSTOM FEATURE ONLY)**

| CUT-OUT | XDIM   | YDIM   | DESCRIPTION                |
|---------|--------|--------|----------------------------|
| 1       | 1.875  | 1.875  | IP STUD M8 x 35mm (Inside) |
| 2       | 1.875  | 58.125 | IP STUD M8 x 35mm (Inside) |
| 3       | 34.125 | 58.125 | IP STUD M8 x 35mm (Inside) |
| 4       | 34.125 | 1.875  | IP STUD M8 x 35mm (Inside) |
| 5       | 1.875  | 30.000 | IP STUD M8 x 35mm (Inside) |
| 6       | 34.125 | 30.000 | IP STUD M8 x 35mm (Inside) |
| 7       | 18.000 | 1.875  | IP STUD M8 x 35mm (Inside) |
| 8       | 18.000 | 58.125 | IP STUD M8 x 35mm (Inside) |
| -----   |        |        |                            |
| 9       | 35.250 | 0.750  | RND Ø0.390                 |
| 10      | 35.250 | 59.250 | RND Ø0.390                 |
| 11      | 0.750  | 59.250 | RND Ø0.390                 |
| 12      | 0.750  | 0.750  | RND Ø0.390                 |

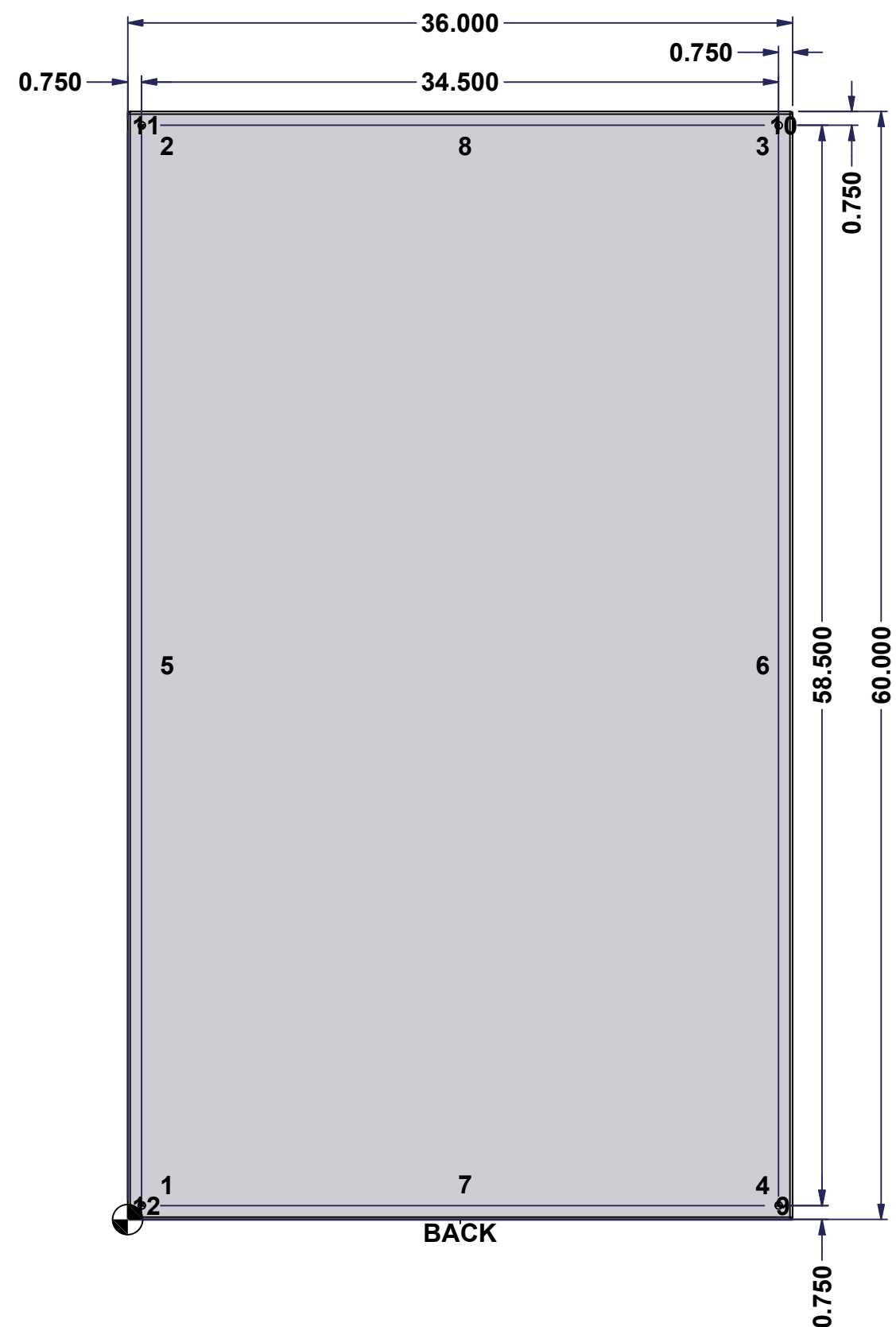

BACK

|                         |                                |          |        |
|-------------------------|--------------------------------|----------|--------|
|                         | Description                    |          | Status |
|                         | 5412EALQT 60" x 36" x 20" Body |          | (NULL) |
| Part Number             |                                | Rev.     | 5      |
| Numéro Pièce            |                                | <b>0</b> | 9      |
| <b>5412EALQT603620B</b> |                                |          |        |

This drawing is confidential and must not be reproduced or used without the consent of EXM

Ce dessin est confidentiel et ne doit pas être reproduit ou utilisé sans le consentement de EXM

| No. | Revisions | Date | By/Par |
|-----|-----------|------|--------|
|     |           |      |        |
|     |           |      |        |
|     |           |      |        |
|     |           |      |        |
|     |           |      |        |

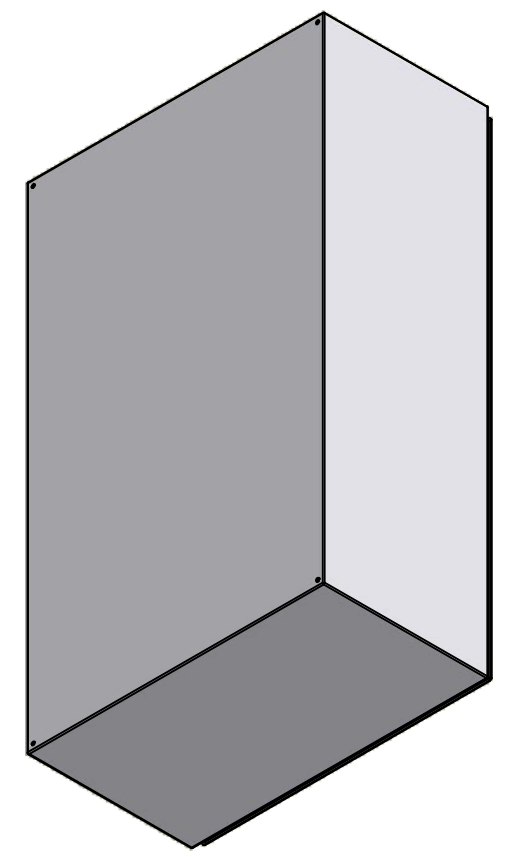

Isometric View



|  |                       |  |
|--|-----------------------|--|
|  Tél: (450) 979-4373<br>Fax: (450) 979-4626<br><a href="http://www.exmweb.com">www.exmweb.com</a> |                       | Flatness<br>Aplatissement<br>Max 3.0mm |
| Customer Client  |                       | Date                                   |
| Drawn By<br>Dessiné Par BoxCad: BoxCad   |                       | Date 18-Dec-14                         |
| Material<br>Matière Aluminum 5052-H32 (2.5mm)  |                       |  |
| Color<br>Couleur Asa-61 Grey   | Finish<br>Fini Smooth |  |
| Description<br>5412EALQT 60" x 36" x 20" Body  |                       | Detail Rev.                            |
| Part Number<br>Numéro Pièce <b>5412EALQT603620B</b>  |                       | Rev. 0                                 |

| Qty        | Part Number        | Rev | Description                         |
|------------|--------------------|-----|-------------------------------------|
| 1          | STK-Q-16090        | 0   | Ground Stud M6 x 16mm Aluminum      |
| 1          | STK-P-02400S       | 0   | Powder Paint (Asa-61 Grey / Smooth) |
| 8          | STK-Q-16010        | 0   | Stud M8 x 35mm Aluminum             |
| 1          | 5412EALQT603620B-P | 0   | 5412EALQT 60" x 36" x 20" Body Part |
| Parts List |                    |     |                                     |

This drawing is confidential and must not be reproduced or used without the consent of EXM

Ce dessin est confidentiel et ne doit pas être reproduit ou utilisé sans le consentement de EXM

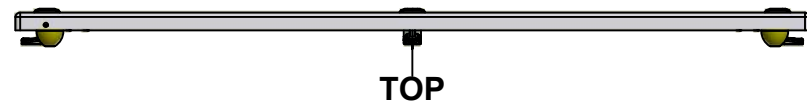

TOP

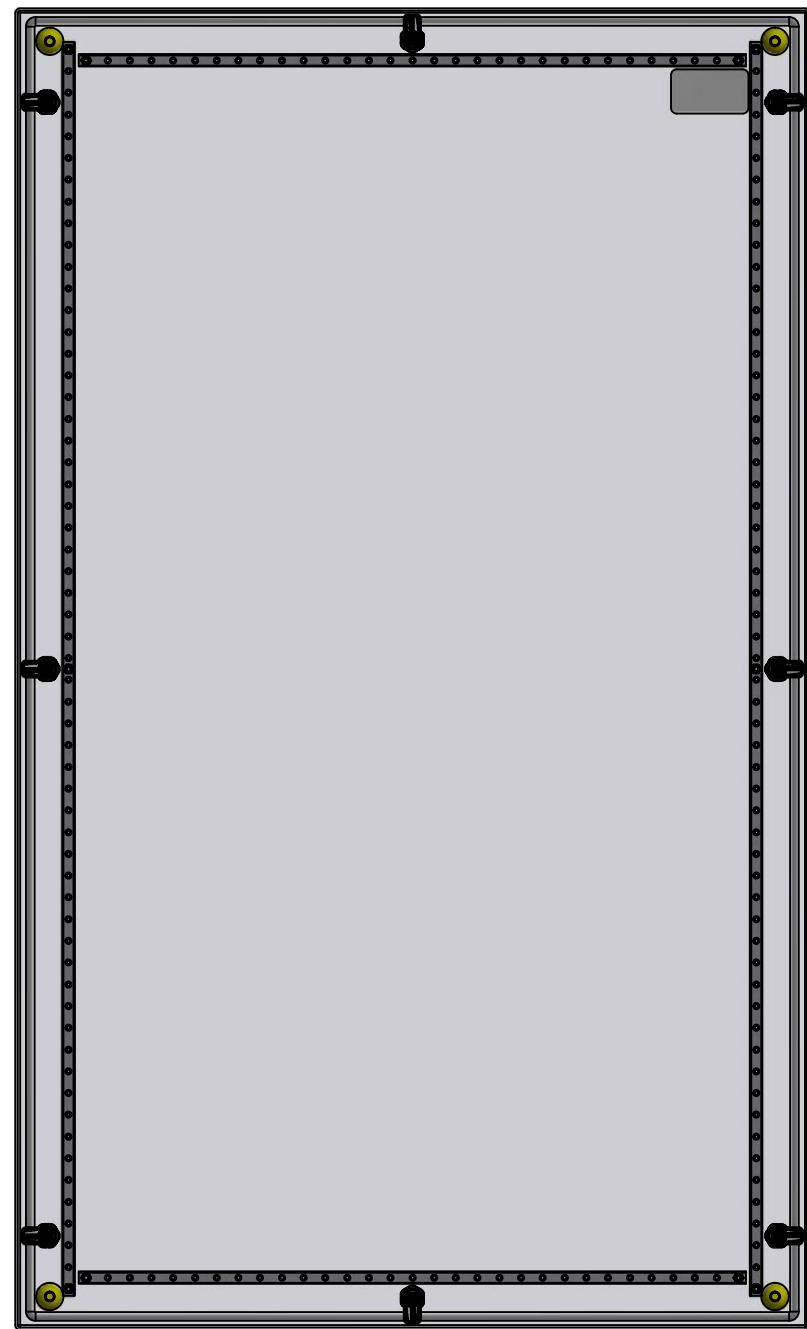

BACK

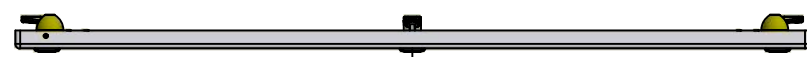

BOTTOM

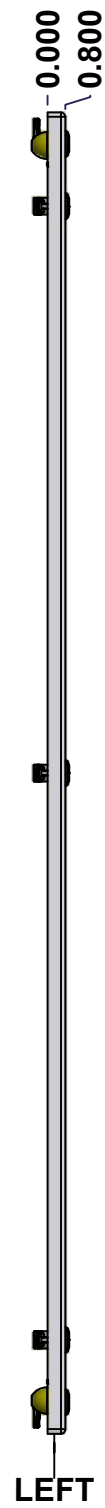

LEFT

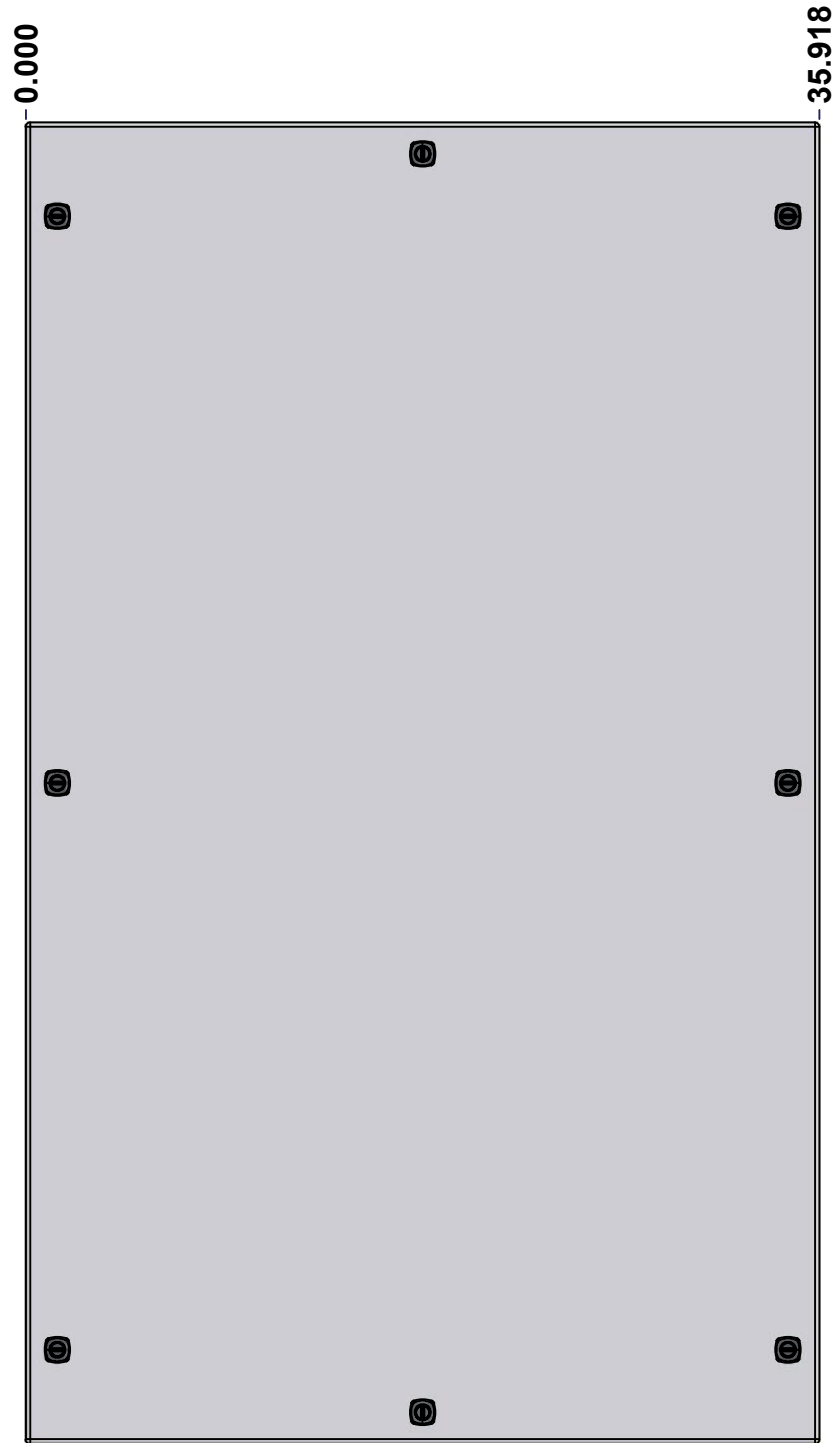

FRONT

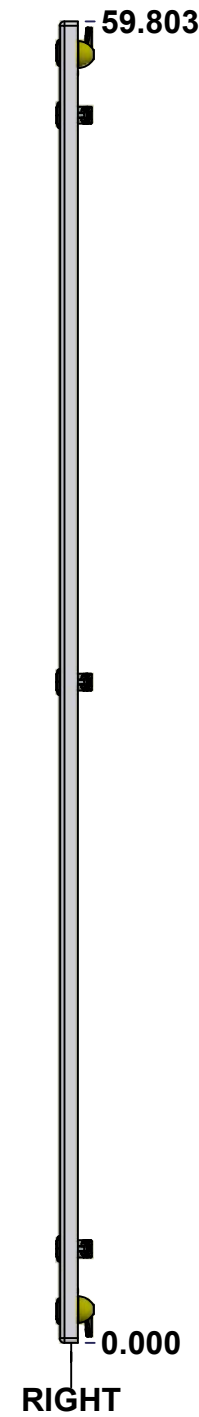

RIGHT

| No. | Revisions | Date | By/Par |
|-----|-----------|------|--------|
|     |           |      |        |
|     |           |      |        |
|     |           |      |        |
|     |           |      |        |

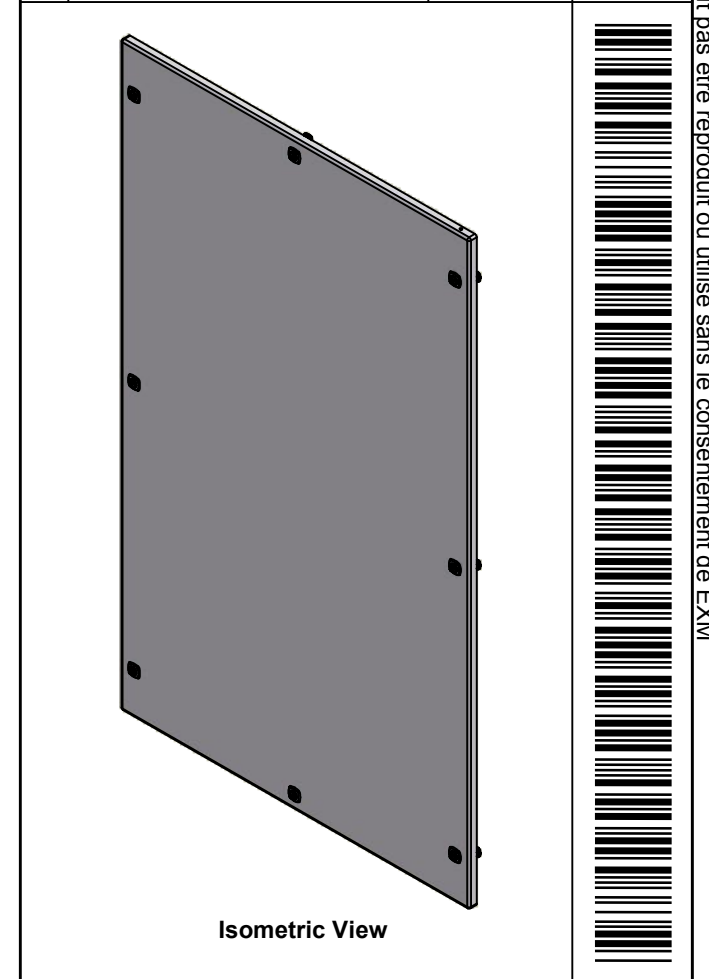

|  |                           |                           |
|--|---------------------------|---------------------------|
| Tél: (450) 979-4373<br>Fax: (450) 979-4626<br><a href="http://www.exmweb.com">www.exmweb.com</a> |                           | Flatness<br>Aplatissement |
|  |                           | Max 3.0mm                 |
| Projection   |                           |                           |
| Customer<br>Client   | Date                      |                           |
| Drawn By<br>Dessiné Par  | BoxCad: BoxCad            | Date 18-Dec-14            |
| Material<br>Matière  | Aluminum 5052-H32 (2.5mm) |                           |
| Color<br>Couleur   | Asa-61 Grey               | Finish<br>Fini Smooth     |
| Description  |                           | Detail Rev.               |
| 5412EALQT 60" x 36" Cover  |                           |                           |
| Part Number<br>Numéro Pièce  | Rev.                      | 7                         |
| SEE BILL OF MATERIAL ON LAST PAGE  | 0                         | 9                         |

SEE BILL OF MATERIAL ON LAST PAGE

**5412EALQT603620C**

This drawing is confidential and must not be reproduced or used without the consent of EXM

Ce dessin est confidentiel et ne doit pas être reproduit ou utilisé sans le consentement de EXM

| STANDARD FEATURES ARE NOT LISTED IN THIS HOLE TABLE |        |        |                           |
|---|--------|--------|---------------------------|
| HOLE TABLE - FRONT VIEW (CUSTOM FEATURE ONLY)       |        |        |                           |
| CUT-OUT   | XDIM   | YDIM   | DESCRIPTION               |
| 1   | 2.401  | 1.850  | STUD M6 x 18mm (Inside)   |
| 2   | 2.401  | 57.953 | STUD M6 x 18mm (Inside)   |
| 3   | 33.517 | 57.953 | STUD M6 x 18mm (Inside)   |
| 4   | 33.517 | 1.850  | STUD M6 x 18mm (Inside)   |
| 5   | 2.401  | 29.902 | STUD M6 x 18mm (Inside)   |
| 6   | 33.517 | 29.902 | STUD M6 x 18mm (Inside)   |
| 7   | 3.195  | 2.350  | STUD M6 x 18mm (Inside)   |
| 8   | 3.195  | 57.453 | STUD M6 x 18mm (Inside)   |
| 9   | 32.723 | 57.453 | STUD M6 x 18mm (Inside)   |
| 10  | 32.723 | 2.350  | STUD M6 x 18mm (Inside)   |
| 11  | 1.550  | 1.500  | STUD M6 x 18mm (Inside)   |
| 12  | 34.368 | 1.500  | STUD M6 x 18mm (Inside)   |
| 13  | 1.550  | 58.303 | STUD M6 x 18mm (Inside)   |
| 14  | 34.368 | 58.303 | STUD M6 x 18mm (Inside)   |
| -----   |        |        |                           |
| 15  | 4.500  | 56.053 | LABEL_EXM (Inside)        |
| 16  | 1.424  | 55.553 | LOCK 880 SCQ4-SL @ 180.0° |
| 17  | 1.424  | 29.902 | LOCK 880 SCQ4-SL @ 180.0° |
| 18  | 1.424  | 4.250  | LOCK 880 SCQ4-SL @ 180.0° |
| 19  | 34.494 | 55.553 | LOCK 880 SCQ4-SL @ 0.0°   |
| 20  | 34.494 | 29.902 | LOCK 880 SCQ4-SL @ 0.0°   |
| 21  | 34.494 | 4.250  | LOCK 880 SCQ4-SL @ 0.0°   |
| 22  | 17.959 | 58.379 | LOCK 880 SCQ4-SL @ 90.0°  |
| 23  | 17.959 | 1.424  | LOCK 880 SCQ4-SL @ 270.0° |

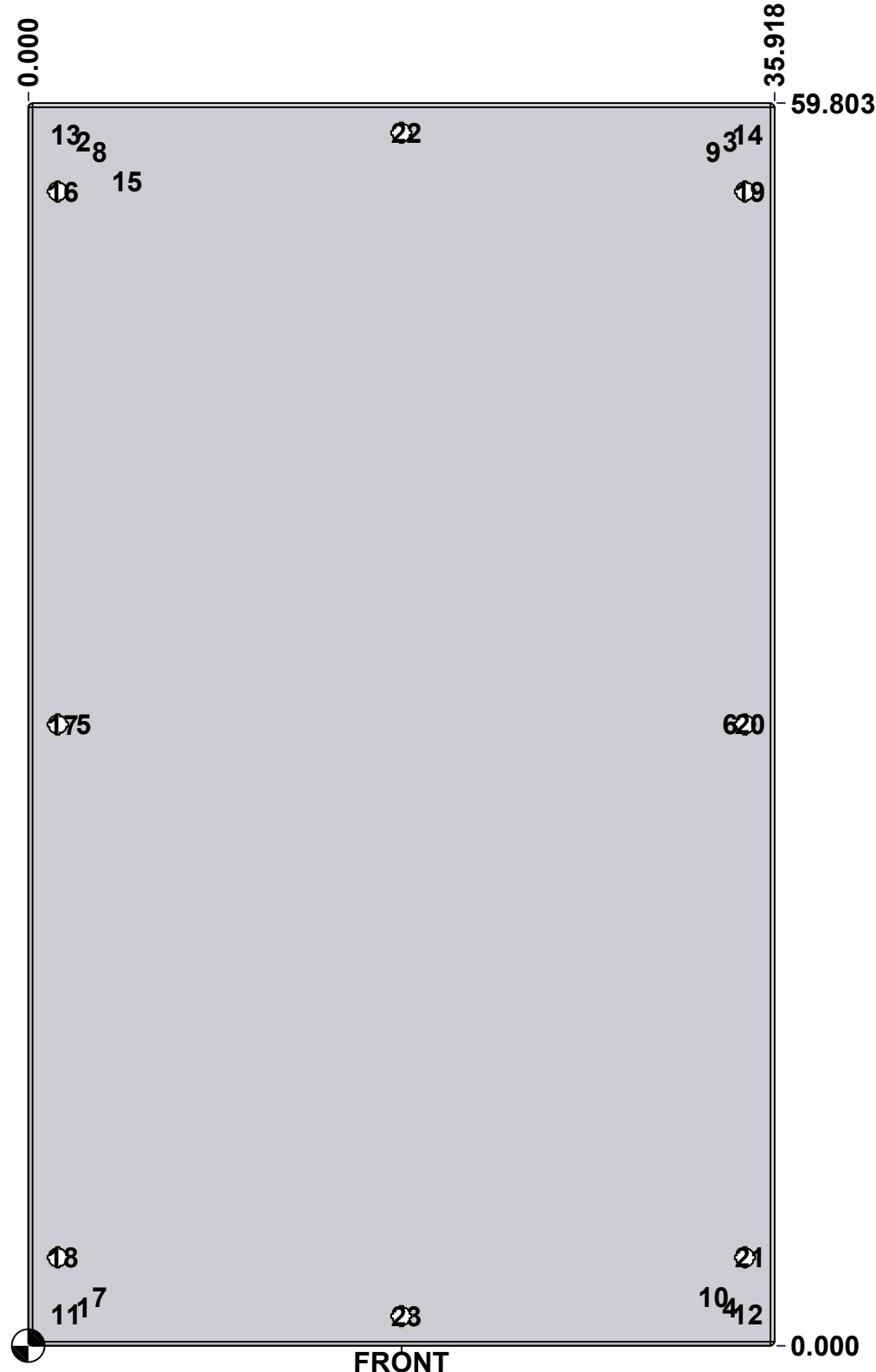

|  |                           |          |
|--|---------------------------|----------|
|  | Description               | Status   |
|  | 5412EALQT 60" x 36" Cover | (NULL)   |
|  | Part Number               | Rev.     |
|  | Numéro Pièce              | 8        |
|  | <b>5412EALQT603620C</b>   | <b>0</b> |
|  |                           | 9        |



This drawing is confidential and must not be reproduced or used without the consent of EXM

Ce dessin est confidentiel et ne doit pas être reproduit ou utilisé sans le consentement de EXM

| No. | Revisions | Date | By/Par |
|-----|-----------|------|--------|
|     |           |      |        |
|     |           |      |        |
|     |           |      |        |
|     |           |      |        |
|     |           |      |        |

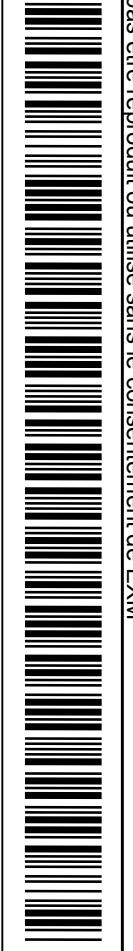
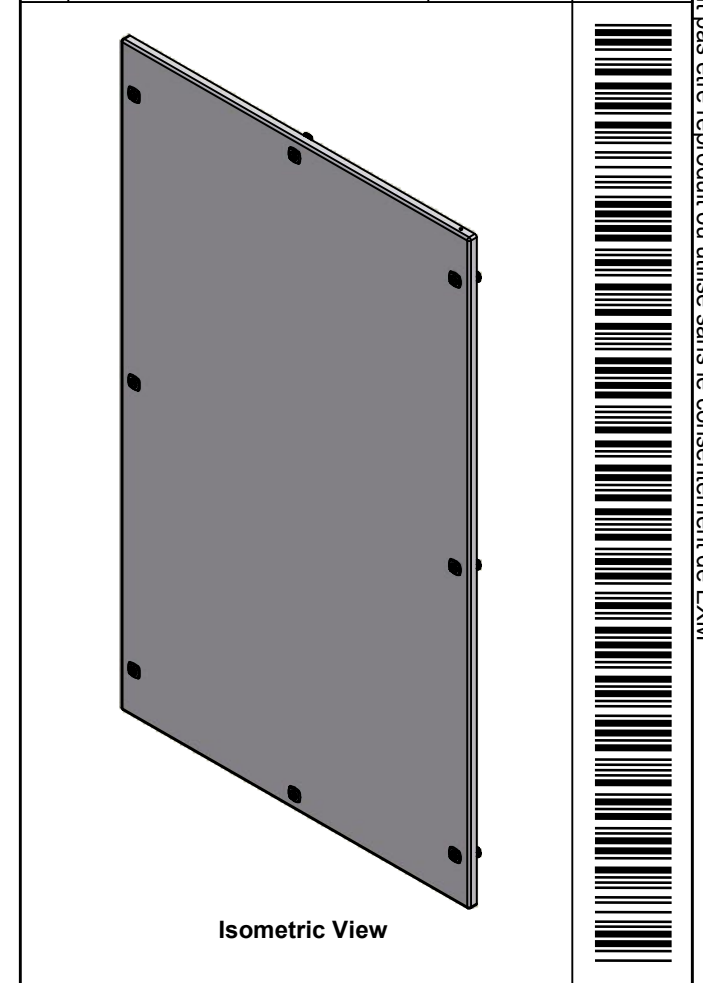



Tél: (450) 979-4373  
Fax: (450) 979-4626  
[www.exmweb.com](http://www.exmweb.com)

Flatness  
Aplatissement  
Max 3.0mm

Projection



| Qty        | Part Name          | Rev       | Description                                   |
|------------|--------------------|-----------|---|
| 1          | STK-S-00100        | 0         | 3.5" x 2" Silver Milar Flexcon Sticker        |
| 1          | STK-P-02400S       | 0         | Powder Paint (Asa-61 Grey / Smooth)           |
| 2          | STK-Q-46020-60     | 5         | 5412 ES Vertical Door Stiffener 60"           |
| 14         | STK-Q-16060        | 0         | Stud M6 x 18mm Aluminum                       |
| 2          | STK-Q-46025-36-3   | 0.1.<br>1 | 5412 ES Horizontal Door Stiffener 36" (3 Pts) |
| 1          | 5412EALQT603620G   | 0         | 5412EALQT 60" x 36" Cover Gasket Part         |
| 1          | 5412EALQT603620C-P | 0         | 5412EALQT 60" x 36" Cover Part                |
| 8          | 880 SCQ4-SL        | 6         | 5412 ES 1/4 Turn Lock                         |
| 10         | STK-Q-07220        | 1         | M6 Nylon Insert Lock Nut                      |
| 4          | STK-Q-46515        | 3         | 5412 ES Door Support with Brass Insert        |
| Parts List |                    |           |   |

|  |                       |
|--|-----------------------|
| Customer<br>Client                                     | Date                  |
| Drawn By<br>Dessiné Par BoxCad: BoxCad                 | Date 18-Dec-14        |
| Material<br>Matière Aluminum 5052-H32 (2.5mm)          |                       |
| Color<br>Couleur Asa-61 Grey                           | Finish<br>Fini Smooth |
| Description<br>5412EALQT 60" x 36" Cover               | Detail Rev.           |
| Part Number<br>Numéro Pièce<br><b>5412EALQT603620C</b> | Rev. <b>0</b> / 9     |

This drawing is confidential and must not be reproduced or used without the consent of EXM

Ce dessin est confidentiel et ne doit pas être reproduit ou utilisé sans le consentement de EXM



TOP

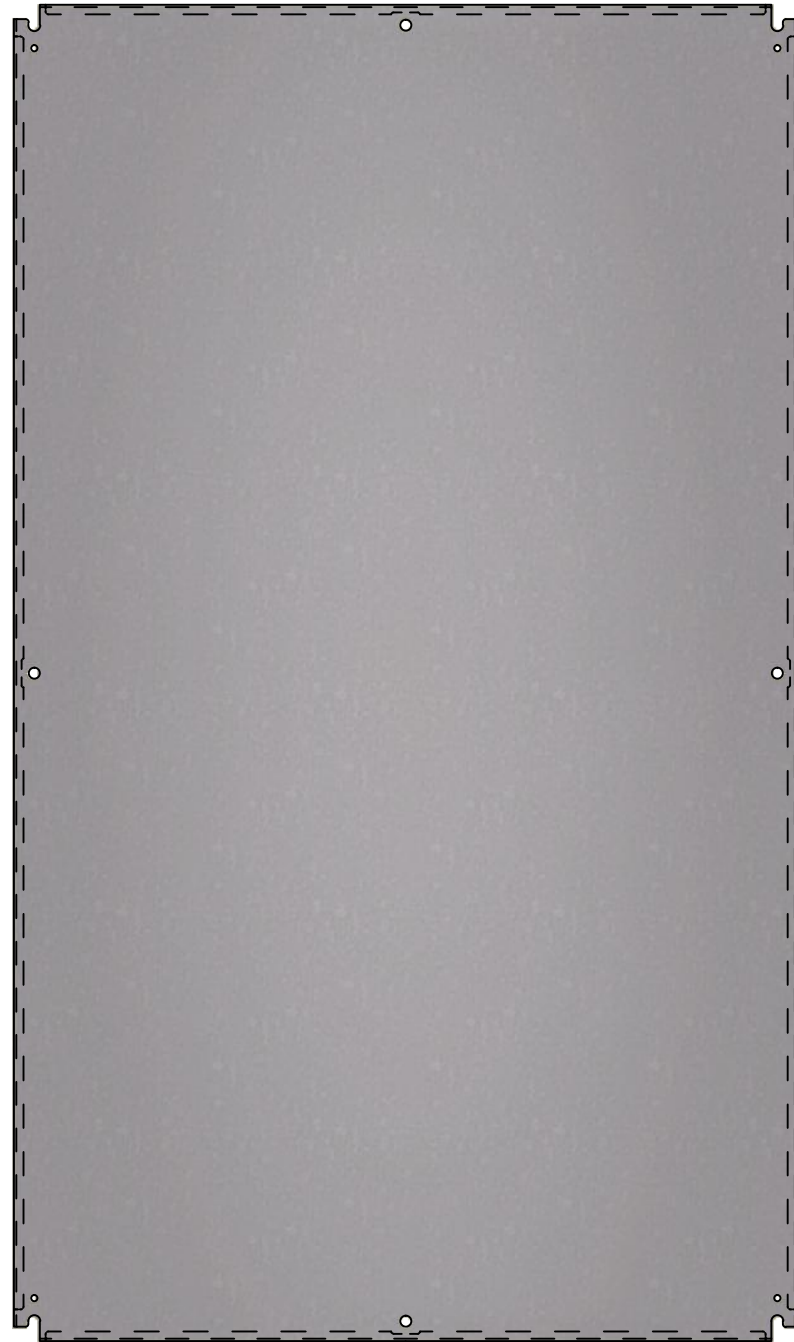

FRONT

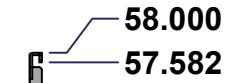

RIGHT

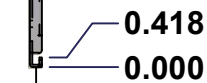

| No. | Revisions | Date | By/Par |
|-----|-----------|------|--------|
|     |           |      |        |
|     |           |      |        |
|     |           |      |        |
|     |           |      |        |
|     |           |      |        |

**Isometric View**

|  |                              |  |
|--|------------------------------|--|
| Tél: (450) 979-4373<br>Fax: (450) 979-4626<br>www.exmweb.com |                              | Flatness<br>Aplatissement<br>Max 3.0mm<br>Projection<br> |
| Customer Client  | Date                         |  |
| Drawn By / Dessiné Par: BoxCad                               | Date: 23-Jan-07              |  |
| Material / Matière   | See Part List                |  |
| Color / Couleur: See Part List                               | Finish / Fini: See Part List |  |
| Description: 881 SP - Inner Panel                            |                              | Detail Rev.  |
| Part Number / Numéro Pièce: <b>881 SP6036G</b>               | Rev.:                        | 1 / 2  |

| Qty | Part Number   | Rev | Description               | Material         | Color     | Finish     |
|-----|---------------|-----|---------------------------|------------------|-----------|------------|
| 1   | 881 SP6036G-P | 0   | 881 SP - Inner Panel Part | 12 Ga Galvanized | Unpainted | Galvanized |

Parts List

This drawing is confidential and must not be reproduced or used without the consent of EXM

Ce dessin est confidentiel et ne doit pas être reproduit ou utilisé sans le consentement de EXM

| Table 1 |        |        | FRONT VIEW                 |
|---------|--------|--------|----------------------------|
| CUT-OUT | XDIM   | YDIM   | DESCRIPTION                |
| 1       | 17.000 | 0.875  | MTG STUD HOLE (RND Ø0.500) |
| 2       | 0.875  | 29.000 | MTG STUD HOLE (RND Ø0.500) |
| 3       | 33.125 | 29.000 | MTG STUD HOLE (RND Ø0.500) |
| 4       | 17.000 | 57.125 | MTG STUD HOLE (RND Ø0.500) |
| 5       | 0.875  | 1.875  | GROUND HOLE (RND Ø0.290)   |
| 6       | 33.125 | 1.875  | GROUND HOLE (RND Ø0.290)   |
| 7       | 0.875  | 56.125 | GROUND HOLE (RND Ø0.290)   |
| 8       | 33.125 | 56.125 | GROUND HOLE (RND Ø0.290)   |

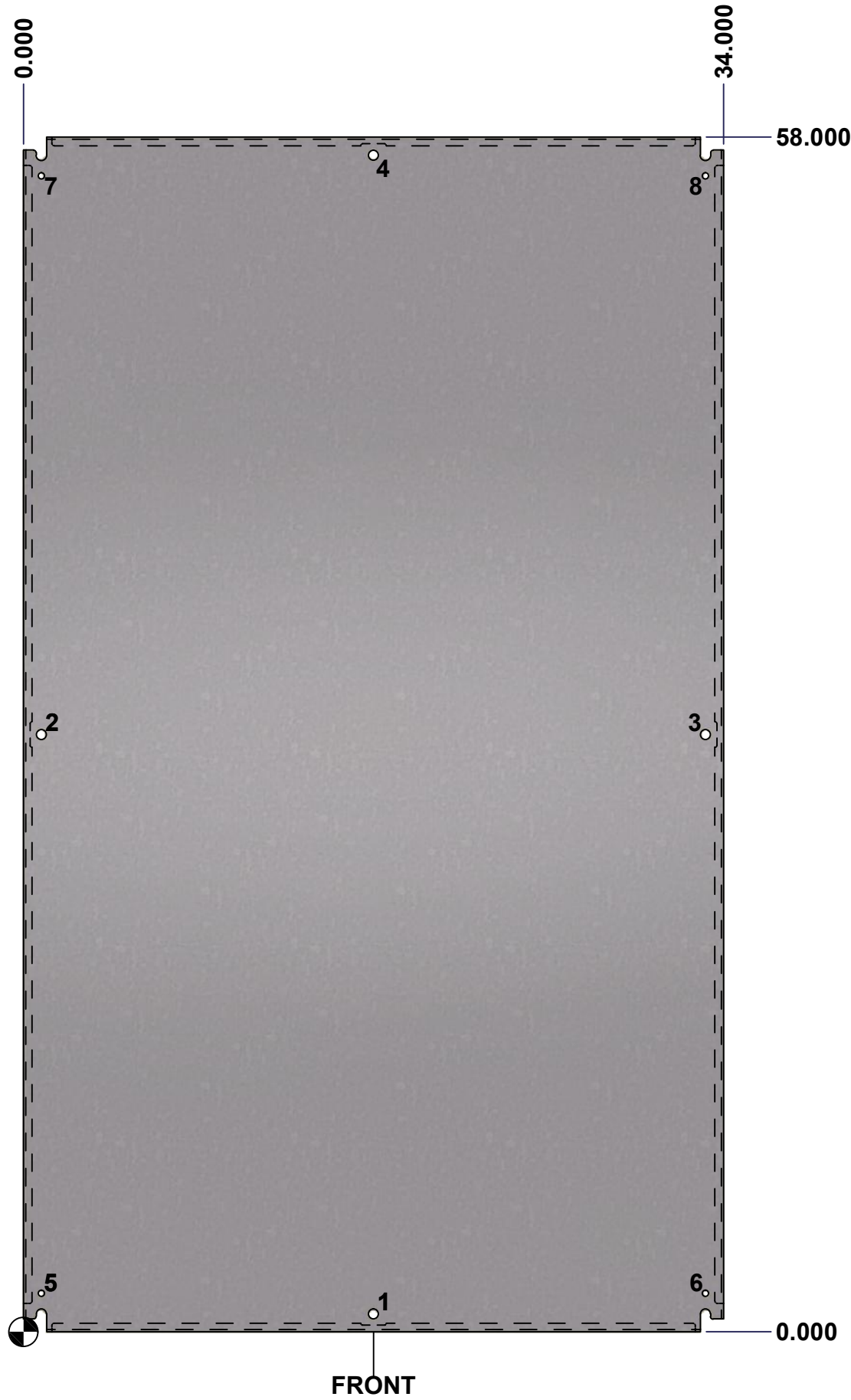

All knockouts are actual size / Les disques défonçables sont grandeur réel

| No. | Revisions | Date | By/Par |
|-----|-----------|------|--------|
|     |           |      |        |
|     |           |      |        |
|     |           |      |        |
|     |           |      |        |
|     |           |      |        |

Isometric View

|   |  |  |  |  |  |
|---|--|--|--|--|--|
|   |  | Tél: (450) 979-4373<br>Fax: (450) 979-4626<br>www.exmweb.com |  | Flatness<br>Aplatissement<br>Max 3.0mm |  |
| Customer<br>Client                                |  | Date   |  | Projection<br>                         |  |
| Drawn By<br>Dessiné Par BoxCad                    |  | Date 23-Jan-07   |  | Material<br>Matière See Part List      |  |
| Color<br>Couleur See Part List                    |  | Finish<br>Fini See Part List                                 |  | Description<br>881 SP - Inner Panel    |  |
| Part Number<br>Numéro Pièce<br><b>881 SP6036G</b> |  | Rev. 0   |  | Detail Rev. 2                          |  |