

This drawing is confidential and must not be reproduced or used without the consent of EXM

Ce dessin est confidentiel et ne doit pas être reproduit ou utilisé sans le consentement de EXM

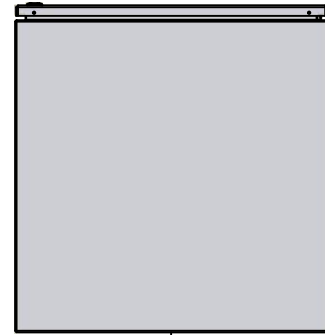

TOP

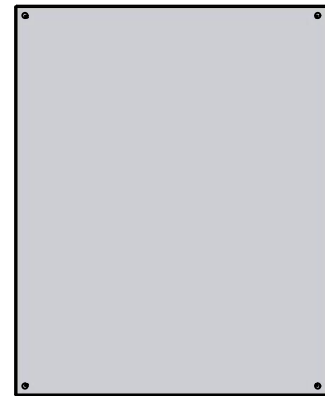

BACK

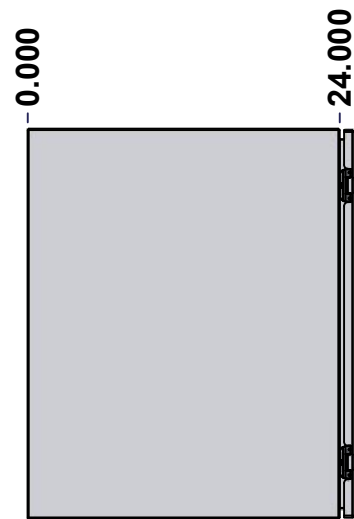

LEFT

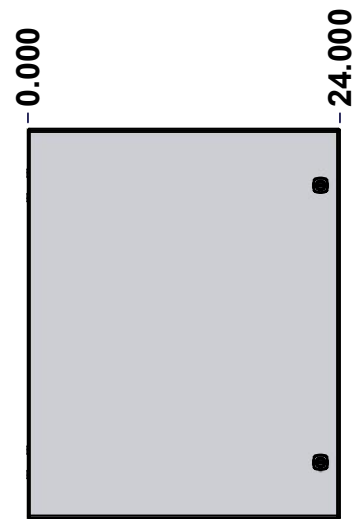

FRONT

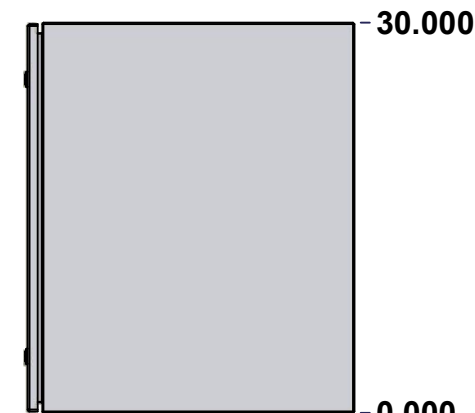

RIGHT

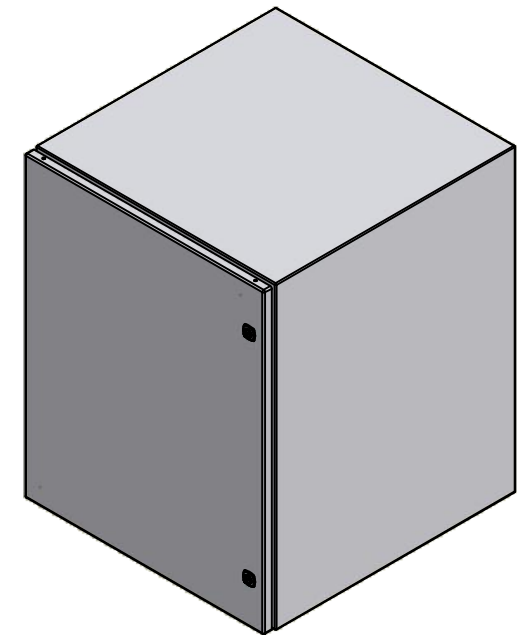

Isometric View



BOTTOM

No.	Revisions	Date	By/Par

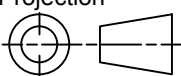
 Tél: (450) 979-4373 Fax: (450) 979-4626 www.exmweb.com		Flatness Aplatissement Max 3.0mm Projection 
Customer Client	Date	
Drawn By Dessiné Par	BoxCad: BoxCad	Date 05-Nov-17
Material Matière	14 Ga Cold Rolled A1008 CS Type B (1.7mm)	
Color Couleur	Asa-61 Grey	Finish Fini Smooth
Description	Detail Rev.	
5412ES 30" x 24" x 24" Assembly		
Part Number Numéro Pièce	Rev. 0	1/9
5412ES302424		

SEE BILL OF MATERIAL ON LAST PAGE

This drawing is confidential and must not be reproduced or used without the consent of EXM

Ce dessin est confidentiel et ne doit pas être reproduit ou utilisé sans le consentement de EXM

NOTE	
ITEM	DESCRIPTION
1	NEMA 4/12 Enclosure
2	C/W Standard ground studs on box and cover
3	C/W Standard door stiffener
4	C/W Standard inner panel (Included)
5	C/W Standard inner panel mounting studs
6	C/W 880 PP included (Not installed)

No.	Revisions	Date	By/Par

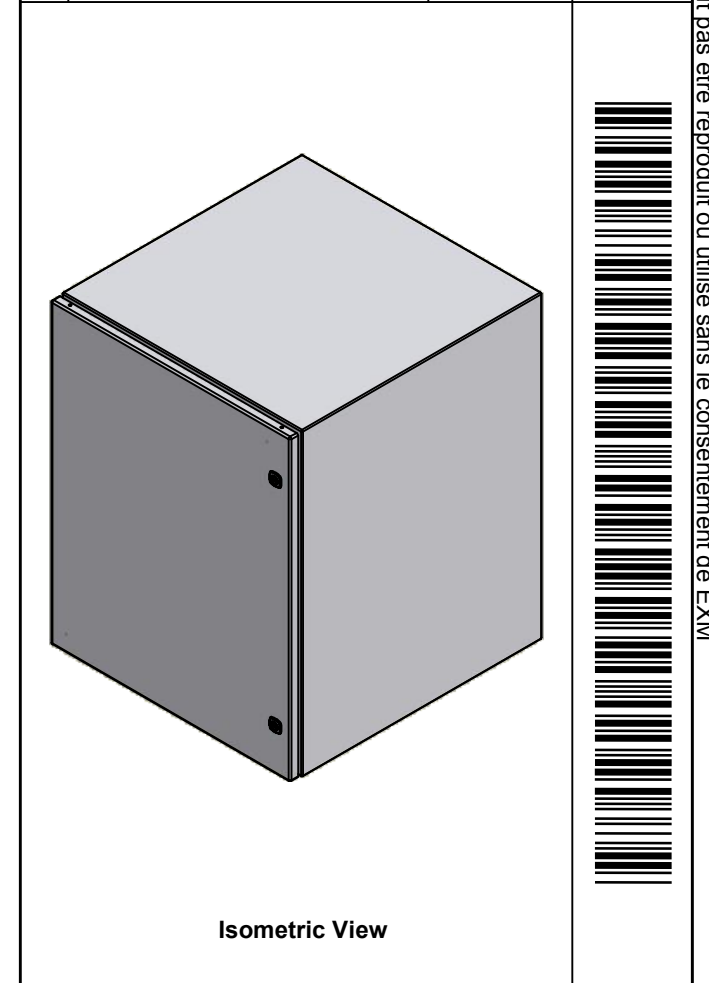

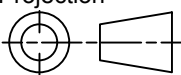
 Tél: (450) 979-4373 Fax: (450) 979-4626 www.exmweb.com	Flatness Aplatissement
	Max 3.0mm
Projection	
Customer Client	Date
Drawn By Dessiné Par BoxCad: BoxCad	Date 05-Nov-17
Material Matière 14 Ga Cold Rolled A1008 CS Type B (1.7mm)	
Color Couleur Asa-61 Grey	Finish Fini Smooth
Description 5412ES 30" x 24" x 24" Assembly	Detail Rev.
Part Number Numéro Pièce 5412ES302424	Rev. 0

PACKING		
ITEM	QTY	DESCRIPTION
Cardboard sleeve	2	Top and Bottom
Cardboard strip	2	Between back of enclosure and inner panel
Plastic bag	1	To protect cover surface and inside gasket
Plastic strap - Black	2	To Squeeze the 2 cardboard sleeve together
Packaging label	1	White label with product number

Qty	Part Number	Rev	Description
1	881 SP3024G	0	881 SP - Inner Panel
2	STK-K-01320	0	5412 ES Inner Panel Accessory Kit
1	880 PP	6	Self Adhesive Print Pocket
1	STK-K-01800	5	5412 ES Accessory Kit
1	5412ES302424C	0	5412ES 30" x 24" Cover
1	5412ES302424B	0	5412ES 30" x 24" x 24" Body
2	STK-Q-04050-08	0	M6 x 8mm Hexagon Socket Head Machine Screw
Parts List			

Part Number Numéro Pièce 5412ES302424	Rev. 0	2
		9

This drawing is confidential and must not be reproduced or used without the consent of EXM

Ce dessin est confidentiel et ne doit pas être reproduit ou utilisé sans le consentement de EXM

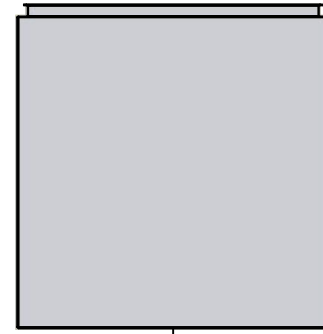

TOP

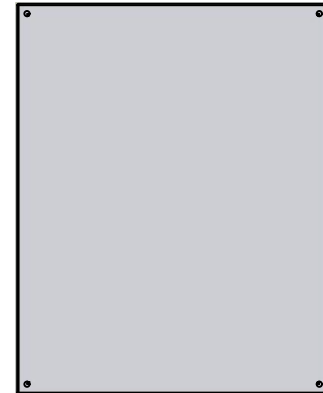

BACK



BOTTOM

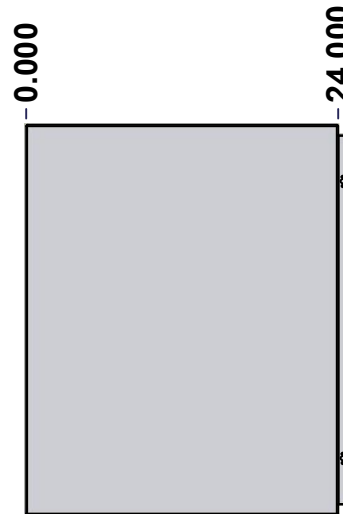

LEFT

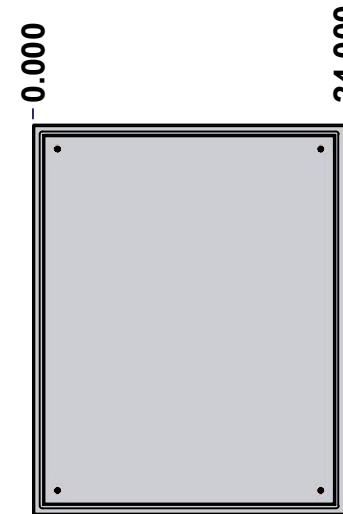

FRONT

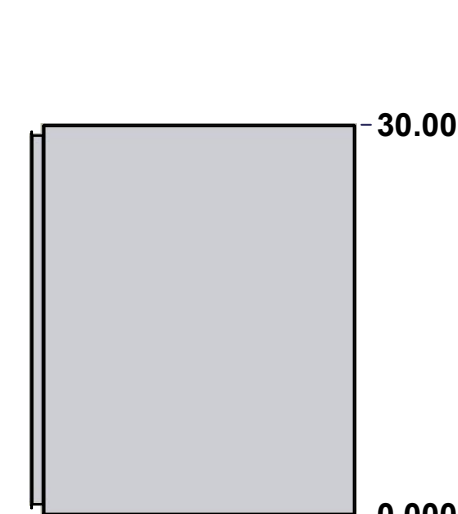

RIGHT

No.	Revisions	Date	By/Par

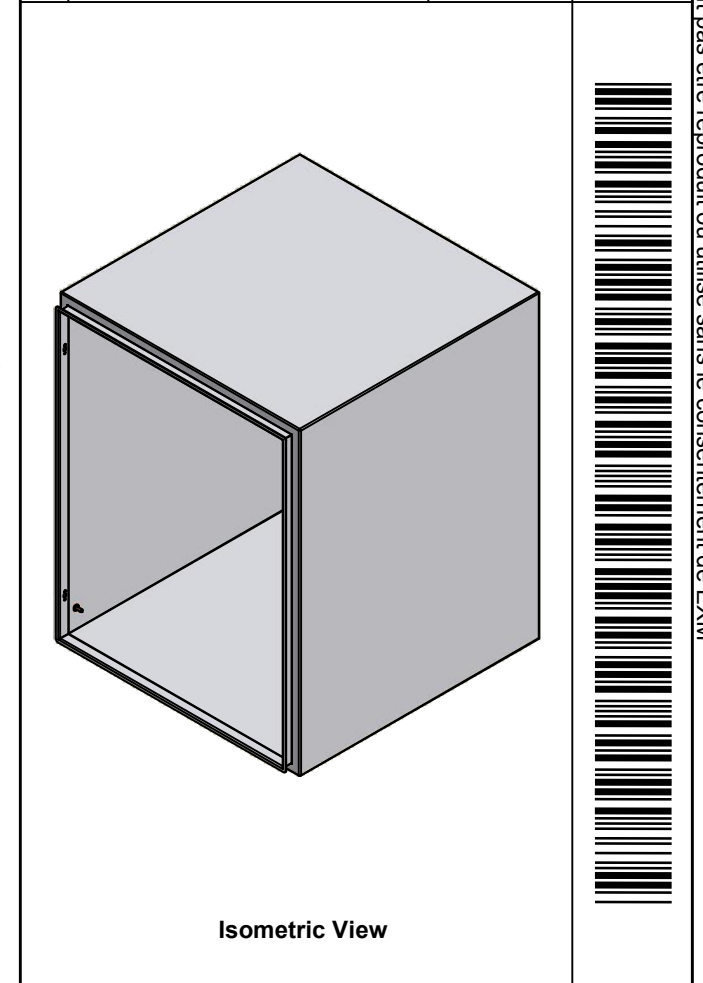

Isometric View

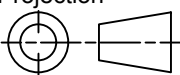

 Tél: (450) 979-4373 Fax: (450) 979-4626 www.exmweb.com		Flatness Aplatissement Max 3.0mm Projection 
Customer Client	Date	
Drawn By Dessiné Par	BoxCad: BoxCad	Date 05-Nov-17
Material Matière	14 Ga Cold Rolled A1008 CS Type B (1.7mm)	
Color Couleur	Asa-61 Grey	Finish Fini Smooth
Description 5412ES 30" x 24" x 24" Body		Detail Rev.
Part Number Numéro Pièce	5412ES302424B	Rev. 3 0

SEE BILL OF MATERIAL ON LAST PAGE

This drawing is confidential and must not be reproduced or used without the consent of EXM

Ce dessin est confidentiel et ne doit pas être reproduit ou utilisé sans le consentement de EXM

STANDARD FEATURES ARE NOT LISTED IN THIS HOLE TABLE			
HOLE TABLE - LEFT VIEW (CUSTOM FEATURE ONLY)			
CUT-OUT	XDIM	YDIM	DESCRIPTION
1	22.500	2.000	GND STUD M6 x 16mm (Inside)

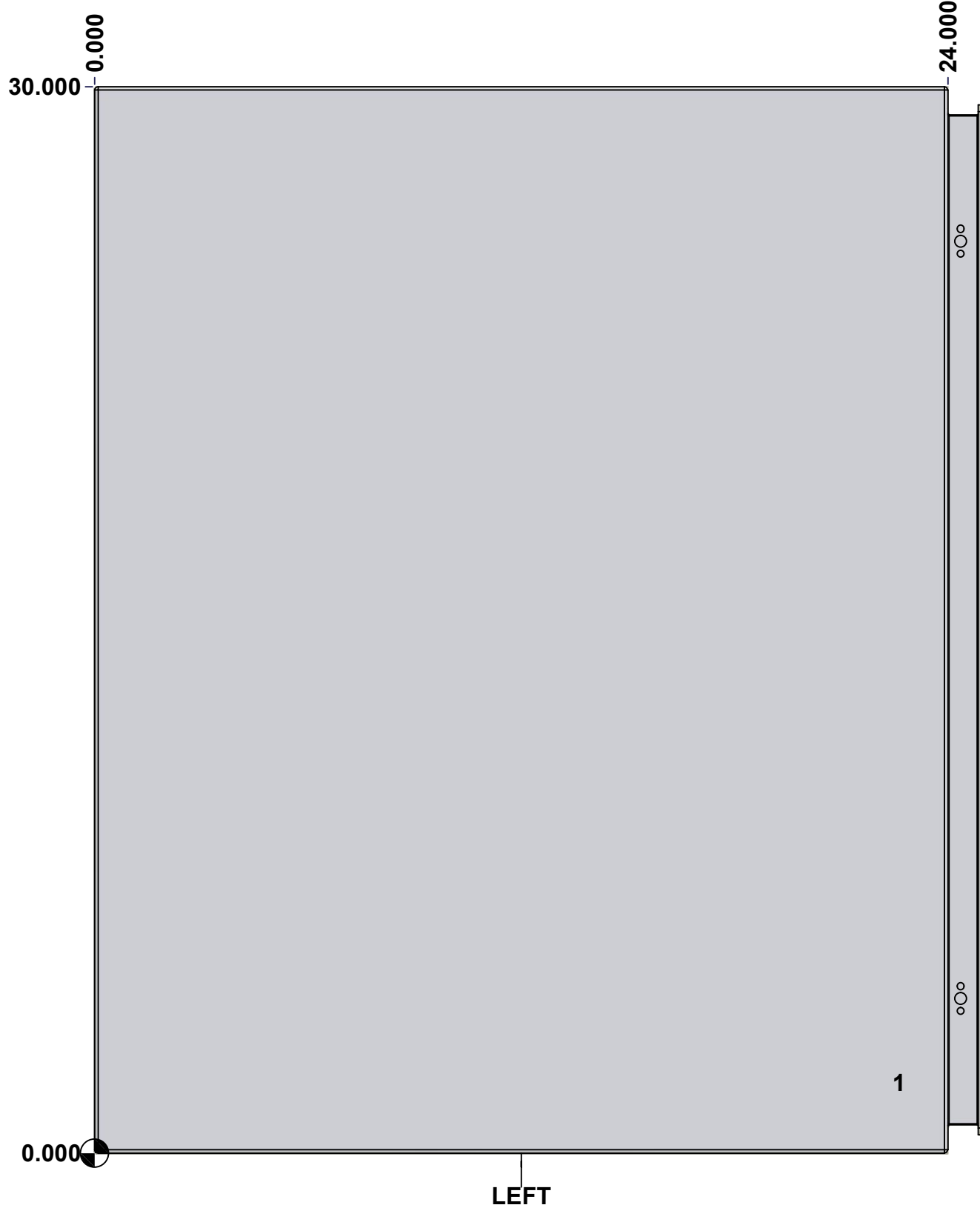

	Description	Status	
	5412ES 30" x 24" x 24" Body	(NULL)	
	Part Number Numéro Pièce	Rev.	
	5412ES302424B	0	4 9

This drawing is confidential and must not be reproduced or used without the consent of EXM

Ce dessin est confidentiel et ne doit pas être reproduit ou utilisé sans le consentement de EXM

STANDARD FEATURES ARE NOT LISTED IN THIS HOLE TABLE

HOLE TABLE - BACK VIEW (CUSTOM FEATURE ONLY)

CUT-OUT	XDIM	YDIM	DESCRIPTION
1	1.875	1.875	IP STUD M8 x 35mm (Inside)
2	1.875	28.125	IP STUD M8 x 35mm (Inside)
3	22.125	28.125	IP STUD M8 x 35mm (Inside)
4	22.125	1.875	IP STUD M8 x 35mm (Inside)

5	0.750	0.750	RND Ø0.390
6	23.250	0.750	RND Ø0.390
7	23.250	29.250	RND Ø0.390
8	0.750	29.250	RND Ø0.390

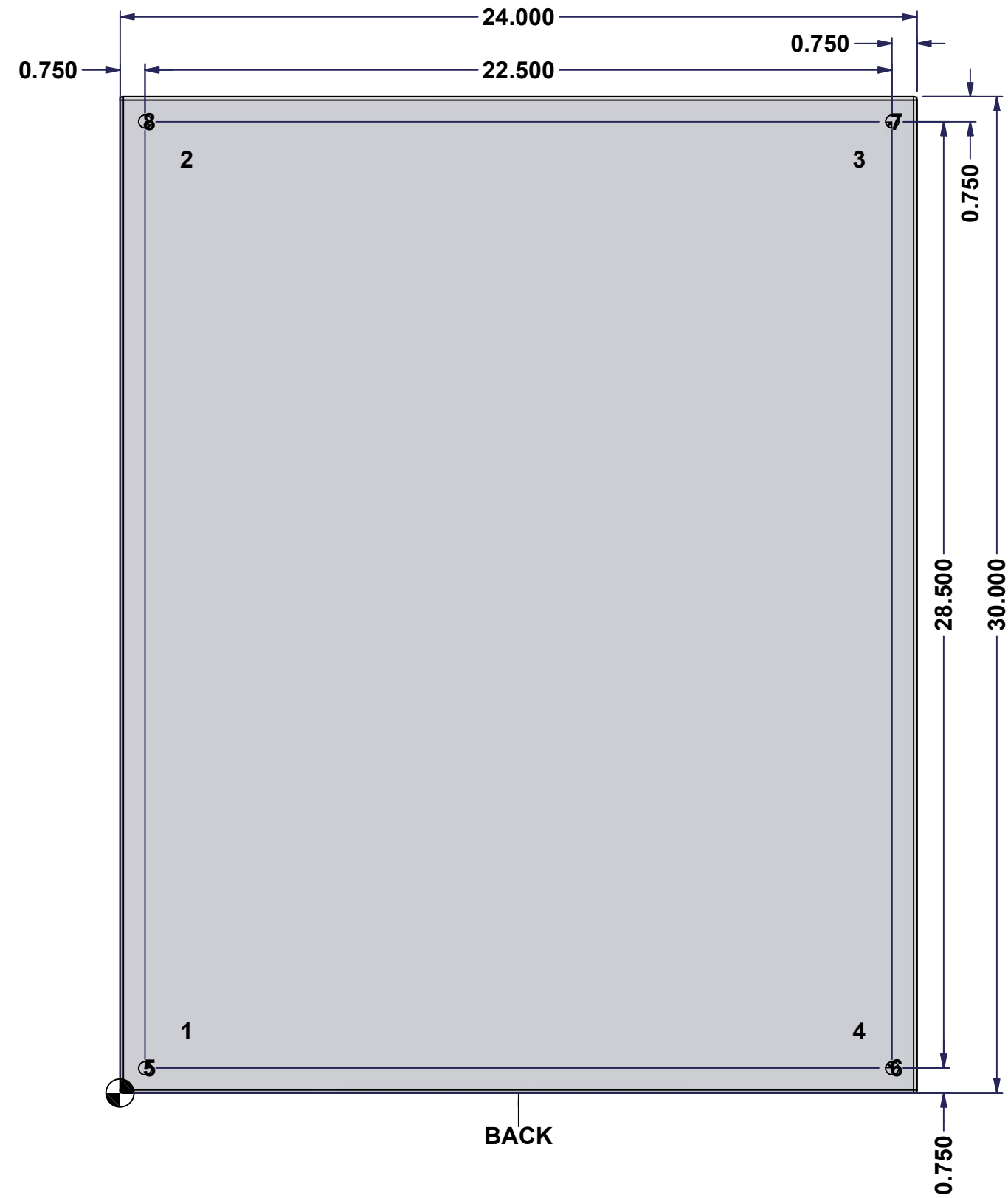

	Description	Status	
	5412ES 30" x 24" x 24" Body	(NULL)	
	Part Number Numéro Pièce	Rev.	5
	5412ES302424B	0	9

This drawing is confidential and must not be reproduced or used without the consent of EXM

Ce dessin est confidentiel et ne doit pas être reproduit ou utilisé sans le consentement de EXM

No.	Revisions	Date	By/Par

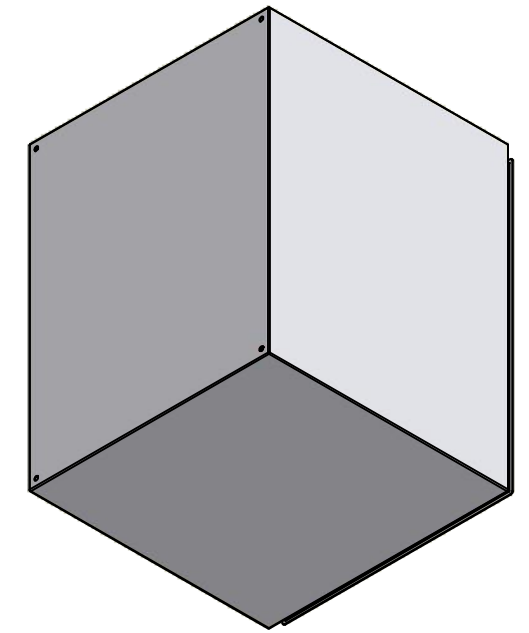

Isometric View

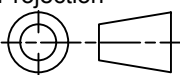

 Tél: (450) 979-4373 Fax: (450) 979-4626 www.exmweb.com		Flatness Aplatissement Max 3.0mm Projection 
Customer Client	Date	
Drawn By / Dessiné Par: BoxCad: BoxCad	Date: 05-Nov-17	
Material / Matière: 14 Ga Cold Rolled A1008 CS Type B (1.7mm)		
Color / Couleur: Asa-61 Grey	Finish / Fini: Smooth	
Description: 5412ES 30" x 24" x 24" Body		Detail Rev.
Part Number / Numéro Pièce: 5412ES302424B		Rev. 6 / 9

Qty	Part Number	Rev	Description
1	STK-Q-16080	0	Ground Stud M6 x 16mm
1	STK-P-02400S	0	Powder Paint (Asa-61 Grey / Smooth)
4	STK-Q-16005	1	Stud M8 x 35 (No Paint Cap Required)
1	5412ES302424B-P	0	5412ES 30" x 24" x 24" Body Part
Parts List			

This drawing is confidential and must not be reproduced or used without the consent of EXM

Ce dessin est confidentiel et ne doit pas être reproduit ou utilisé sans le consentement de EXM



TOP

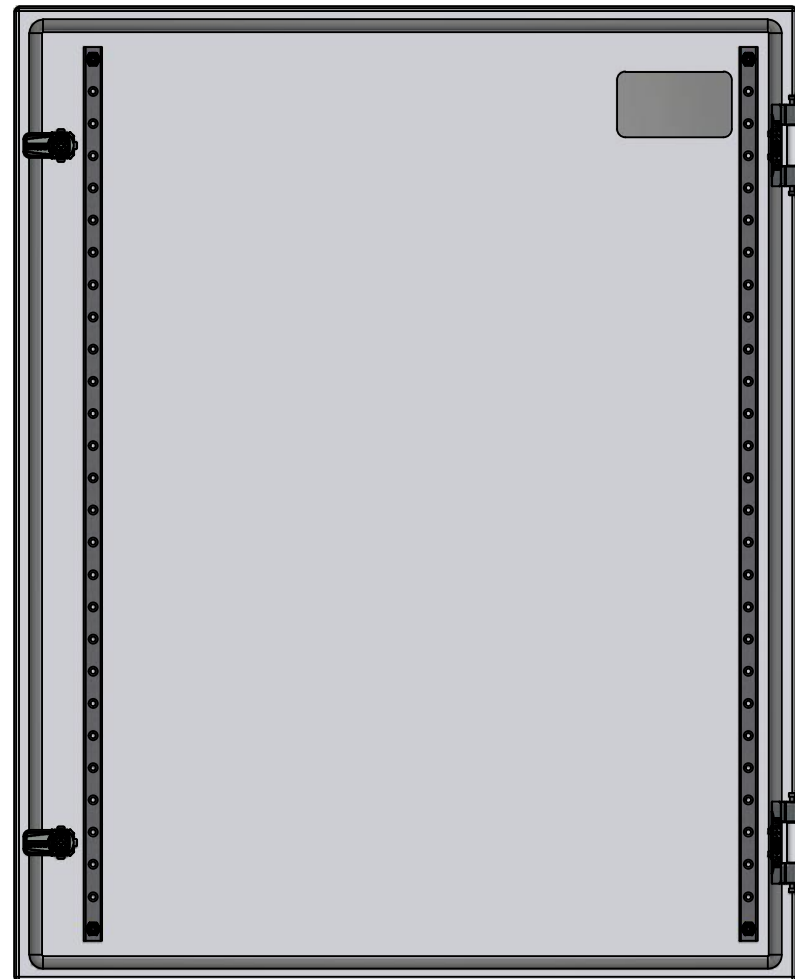

BACK

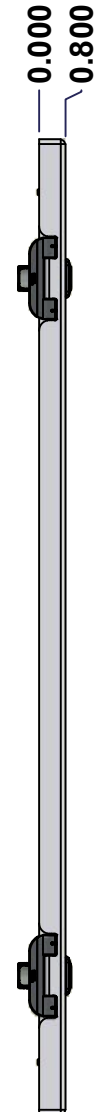

LEFT

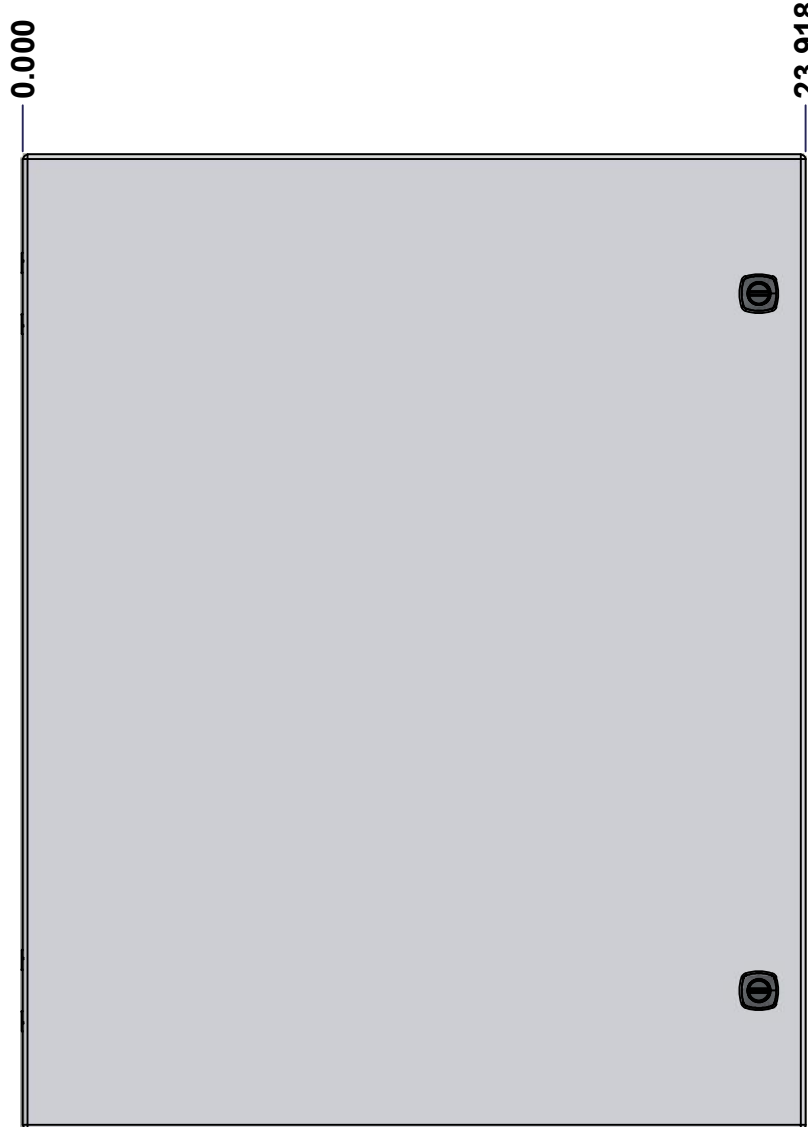

FRONT

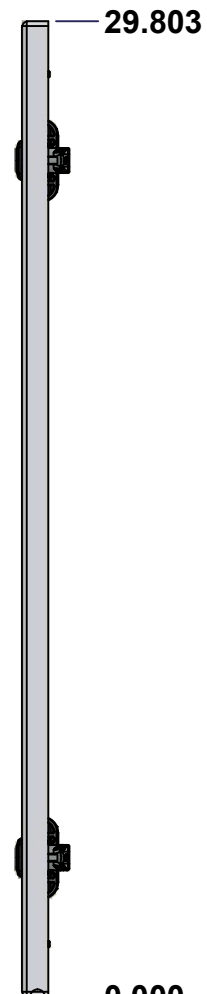

RIGHT



BOTTOM

No.	Revisions	Date	By/Par

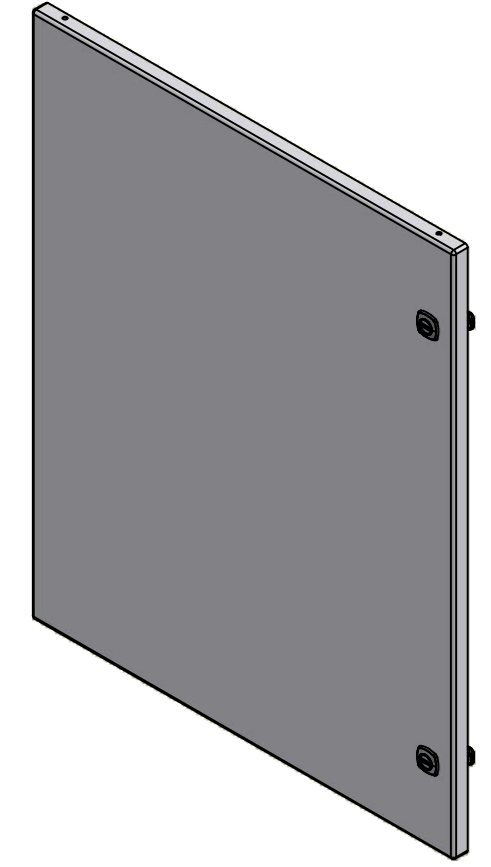

Isometric View



EXM
 Tél: (450) 979-4373
 Fax: (450) 979-4626
www.exmweb.com

Flatness
 Aplatissement
 Max 3.0mm
 Projection

Customer Client	Date
Drawn By / Dessiné Par: BoxCad: BoxCad	Date: 05-Nov-17
Material / Matière: 16 Ga Cold Rolled A1008 CS Type B (1.4mm)	

Color / Couleur: Asa-61 Grey	Finish / Fini: Smooth
------------------------------	-----------------------

Description: 5412ES 30" x 24" Cover	Detail Rev.
-------------------------------------	-------------

Part Number / Numéro Pièce: 5412ES302424C	Rev. 0	7	9
--	--------	---	---

SEE BILL OF MATERIAL ON LAST PAGE

This drawing is confidential and must not be reproduced or used without the consent of EXM

Ce dessin est confidentiel et ne doit pas être reproduit ou utilisé sans le consentement de EXM

STANDARD FEATURES ARE NOT LISTED IN THIS HOLE TABLE

HOLE TABLE - FRONT VIEW (CUSTOM FEATURE ONLY)

CUT-OUT	XDIM	YDIM	DESCRIPTION
1	1.486	1.614	STUD M6 x 18mm (Inside)
2	1.486	28.189	STUD M6 x 18mm (Inside)
3	21.517	28.189	STUD M6 x 18mm (Inside)
4	21.517	1.614	STUD M6 x 18mm (Inside)

5	3.750	26.803	LABEL_EXM (Inside)
6	22.494	4.250	LOCK 880 SCQ4-SL @ 0.0°
7	22.494	25.553	LOCK 880 SCQ4-SL @ 0.0°

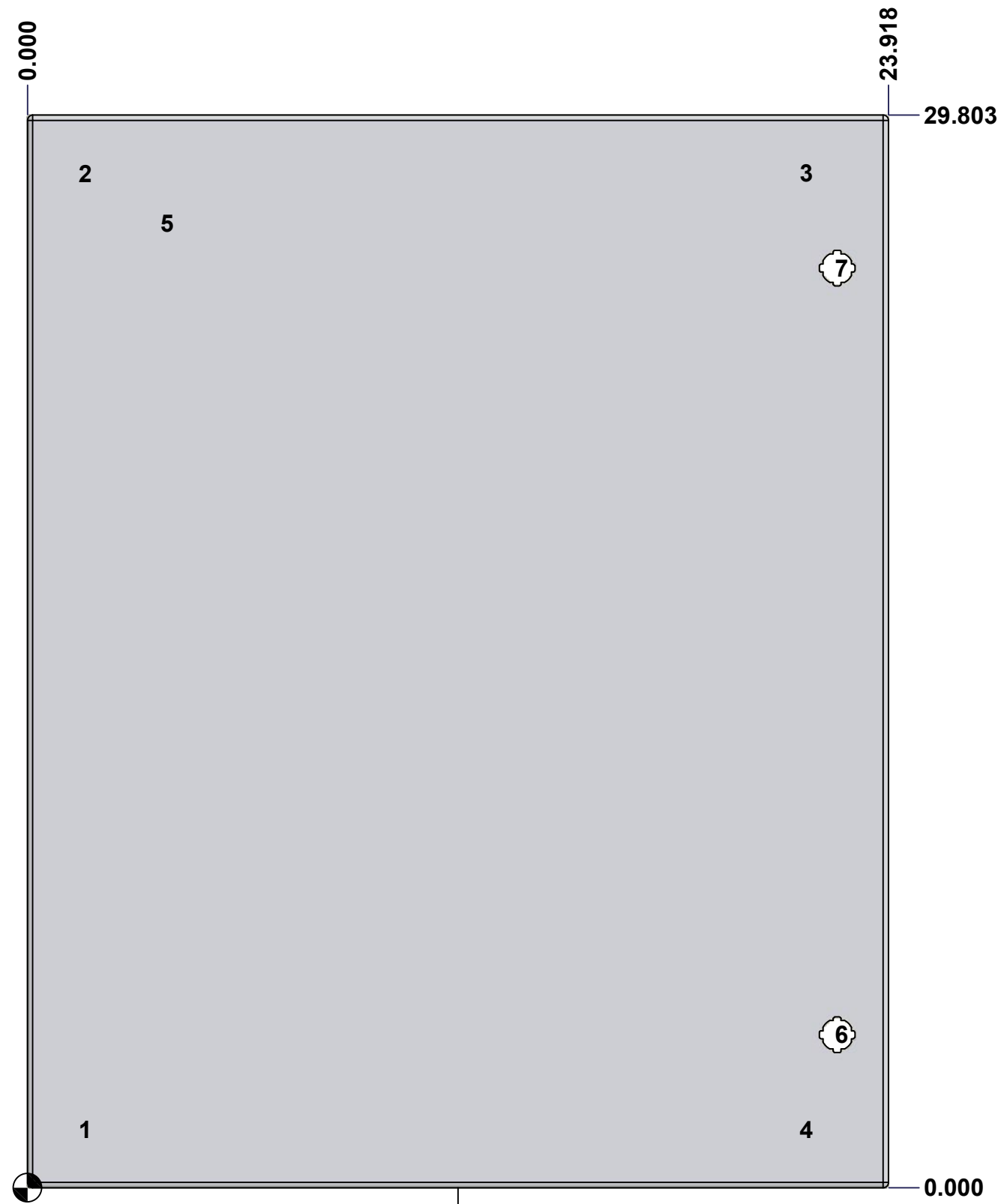

FRONT

	Description	Status
	5412ES 30" x 24" Cover	(NULL)
	Part Number Numéro Pièce	Rev.
	5412ES302424C	0 / 8 / 9

This drawing is confidential and must not be reproduced or used without the consent of EXM

Ce dessin est confidentiel et ne doit pas être reproduit ou utilisé sans le consentement de EXM

No.	Revisions	Date	By/Par

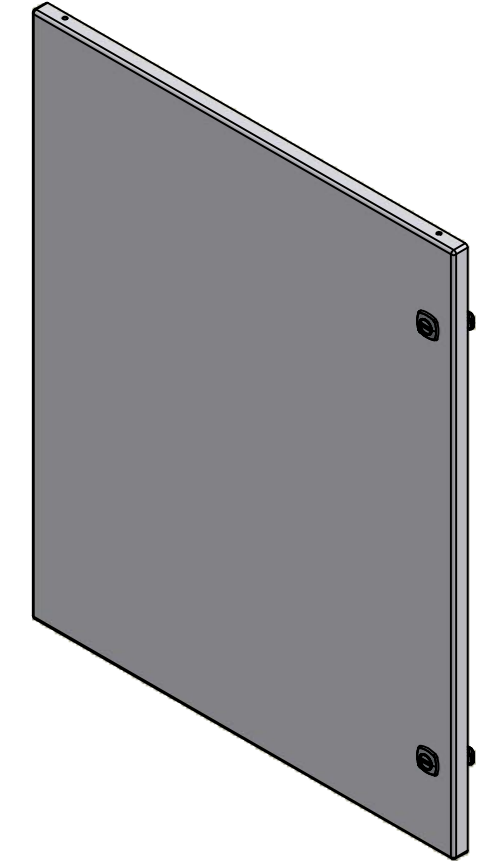

Isometric View



 Tél: (450) 979-4373
 Fax: (450) 979-4626
www.exmweb.com

Flatness / Aplatissement: Max 3.0mm
 Projection: 

Customer / Client	Date
Drawn By / Dessiné Par: BoxCad: BoxCad	Date: 05-Nov-17
Material / Matière: 16 Ga Cold Rolled A1008 CS Type B (1.4mm)	

Color / Couleur: Asa-61 Grey	Finish / Fini: Smooth
Description: 5412ES 30" x 24" Cover	
Detail Rev.	

Part Number / Numéro Pièce: 5412ES302424C	Rev. 0	9
--	--------	---

Qty	Part Name	Rev	Description
1	STK-S-00100	0	3.5" x 2" Silver Milar Flexcon Sticker
1	STK-P-02400S	0	Powder Paint (Asa-61 Grey / Smooth)
2	STK-Q-46020-30	5	5412 ES Vertical Door Stiffener 30"
4	STK-Q-16055	1	M6 x 18mm Stud (No Paint Cap Required)
1	5412ES302424G	0	5412ES 30" x 24" Cover Gasket Part
1	5412ES302424C-P	0	5412ES 30" x 24" Cover Part
2	STK-K-09800	10	5412 ES Hinge with 2 Captive Hinge Pins
2	STK-K-12500	16	5412 ES 1/4 Turn Lock
4	STK-Q-07220	1	M6 Nylon Insert Lock Nut
Parts List			

This drawing is confidential and must not be reproduced or used without the consent of EXM

Ce dessin est confidentiel et ne doit pas être reproduit ou utilisé sans le consentement de EXM

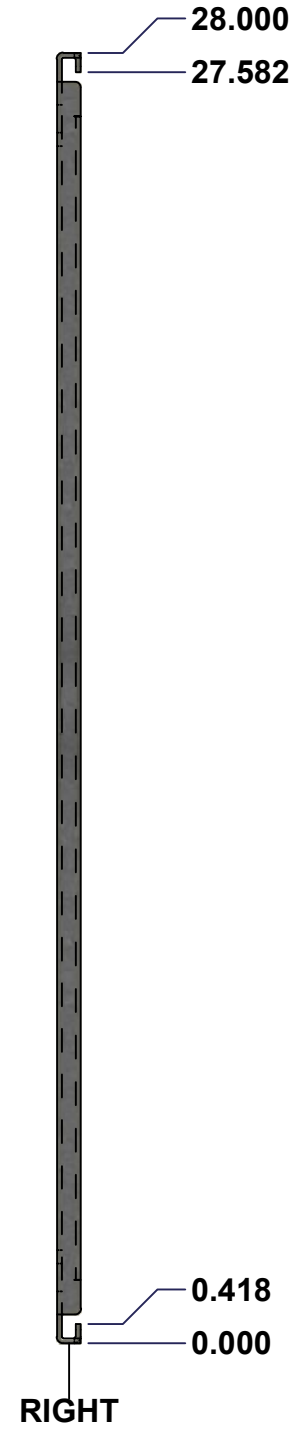
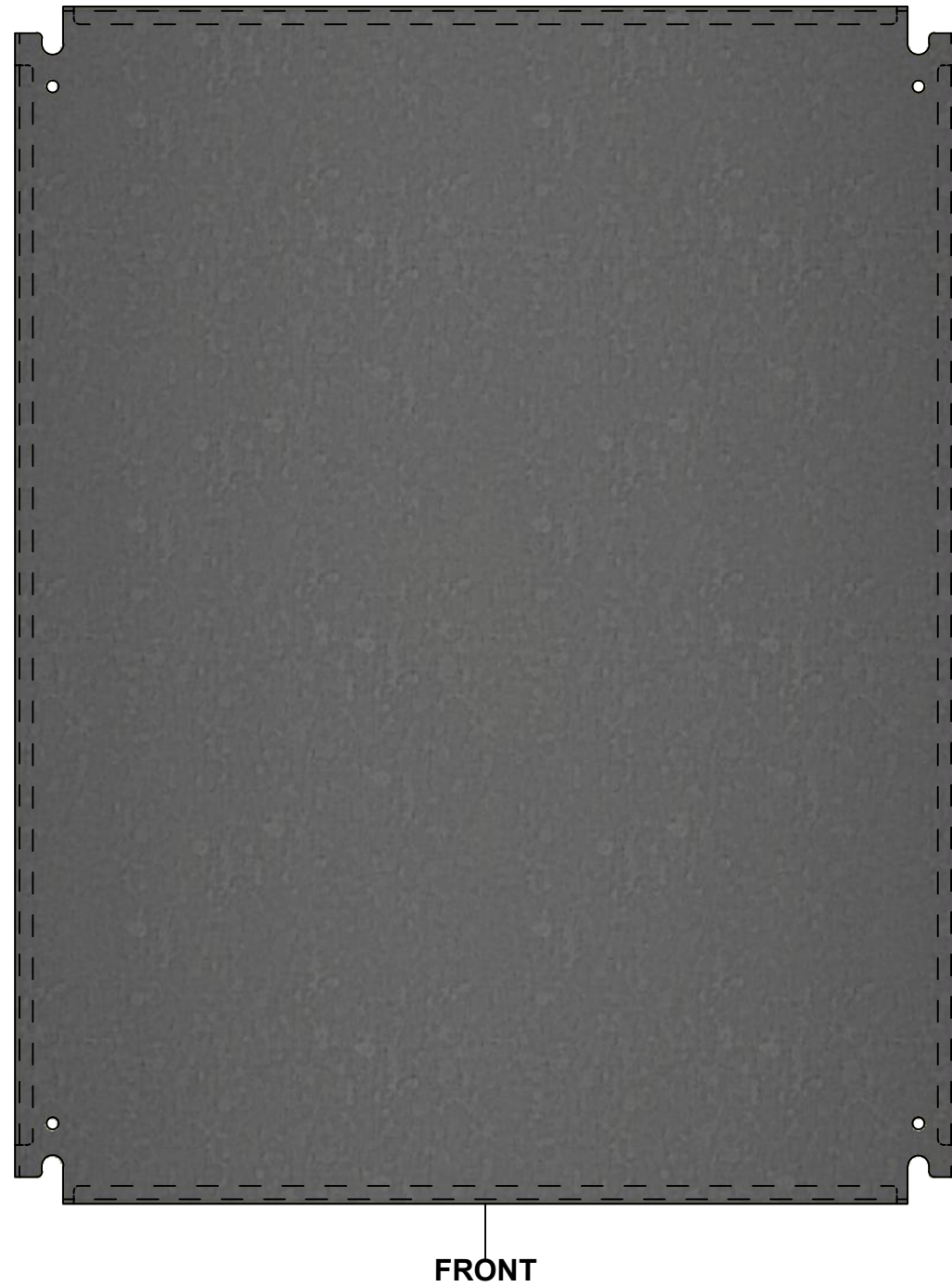
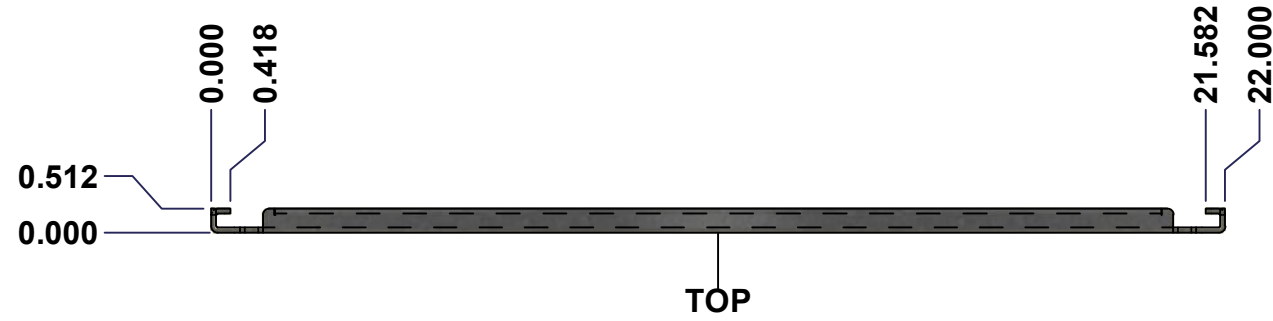

No.	Revisions	Date	By/Par



	Flatness Aplatissement Max 3.0mm
	Projection
Tél: (450) 979-4373 Fax: (450) 979-4626 www.exmweb.com	Customer Client Date
Drawn By Dessiné Par BoxCad	Date 1/23/2007
Material Matière See Part List	
Color Couleur See Part List	Finish Fini See Part List
Description 881 SP - Inner Panel	
Detail Rev.	
Part Number Numéro Pièce 881 SP3024G	Rev. 1 0

Qty	Part Number	Rev	Description	Material	Color	Finish
1	881 SP3024G-P	0	881 SP - Inner Panel Part	12 Ga Galvanized	Unpainted	Galvanized

Parts List

This drawing is confidential and must not be reproduced or used without the consent of EXM

Ce dessin est confidentiel et ne doit pas être reproduit ou utilisé sans le consentement de EXM

Table 1			FRONT VIEW
CUT-OUT	XDIM	YDIM	DESCRIPTION
1	0.875	1.875	GROUND HOLE (RND Ø0.290)
2	21.125	1.875	GROUND HOLE (RND Ø0.290)
3	0.875	26.125	GROUND HOLE (RND Ø0.290)
4	21.125	26.125	GROUND HOLE (RND Ø0.290)

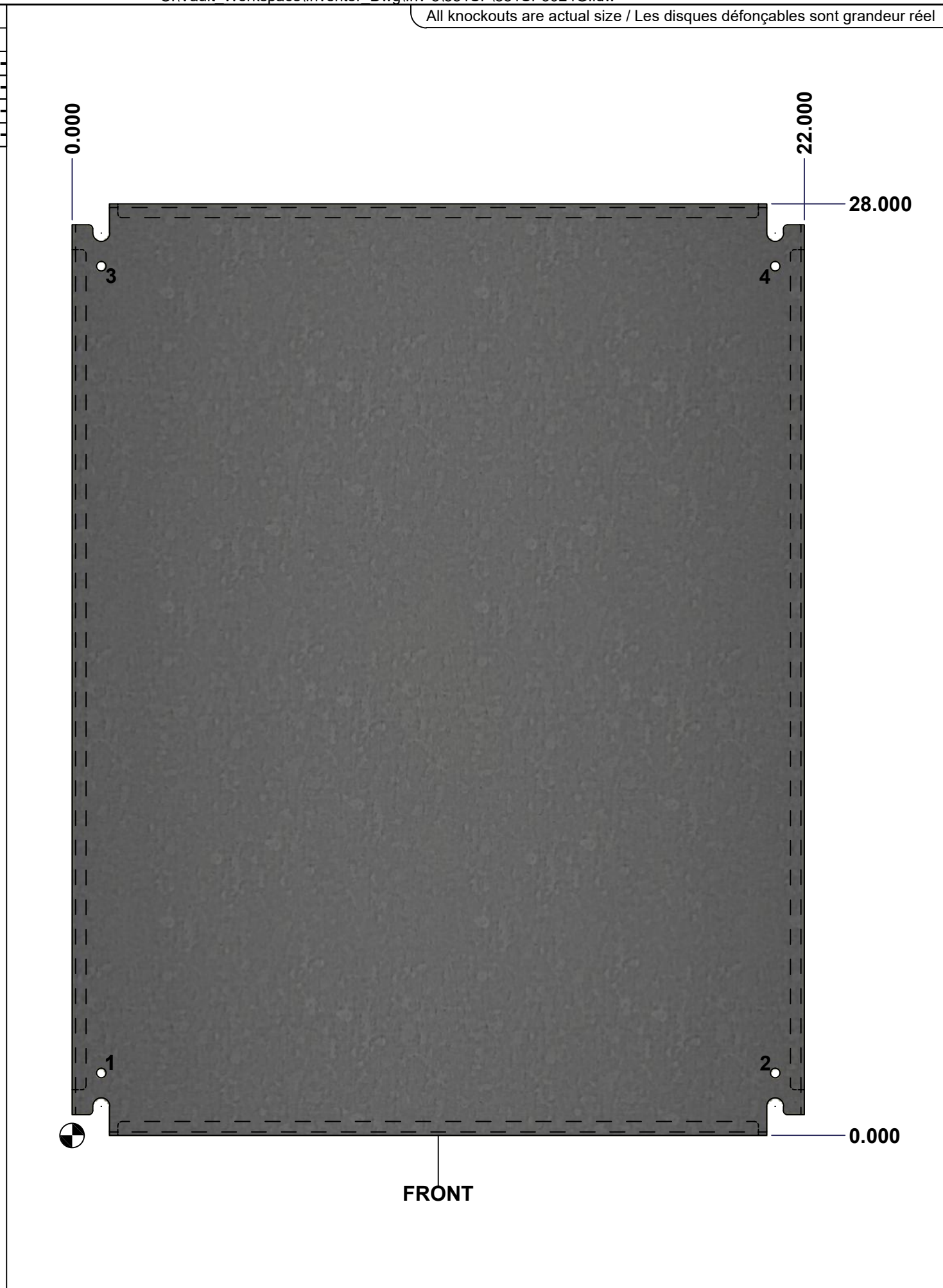

All knockouts are actual size / Les disques défonçables sont grandeur réel

No.	Revisions	Date	By/Par

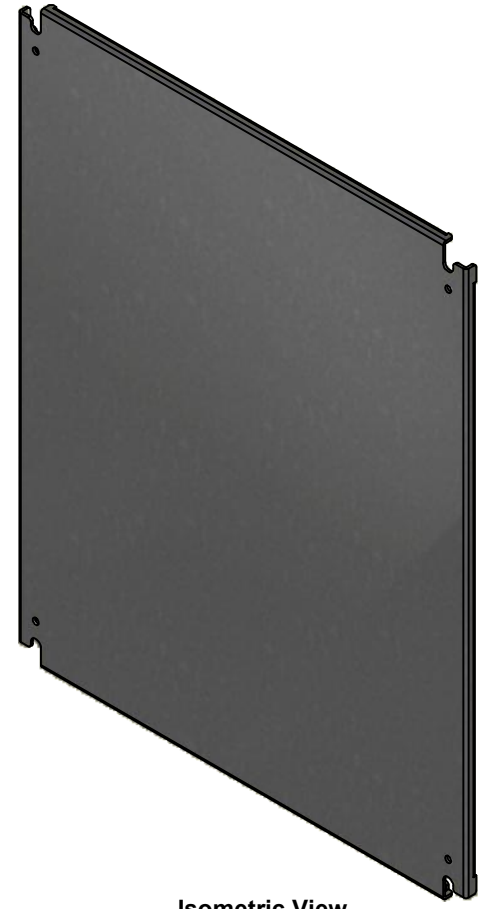

	Tél: (450) 979-4373 Fax: (450) 979-4626 www.exmweb.com	Flatness Aplatissement Max 3.0mm
		Projection
Customer Client		Date
Drawn By Dessiné Par	BoxCad	Date 1/23/2007
Material Matière	See Part List	
Color Couleur	See Part List	Finish Fini See Part List
Description	881 SP - Inner Panel	
Part Number Numéro Pièce	881 SP3024G	Detail Rev. Rev. 2 0