

This drawing is confidential and must not be reproduced or used without the consent of EXM

Ce dessin est confidentiel et ne doit pas être reproduit ou utilisé sans le consentement de EXM

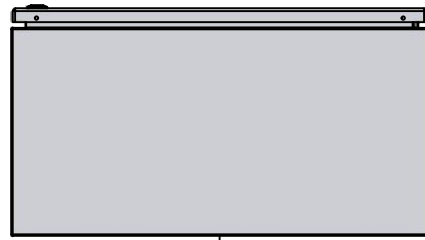

TOP

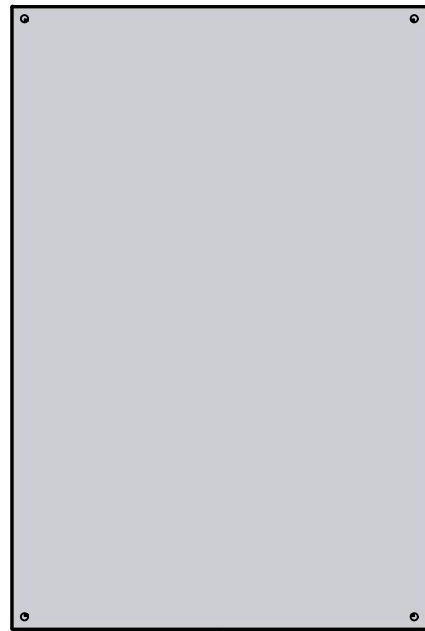

BACK



BOTTOM

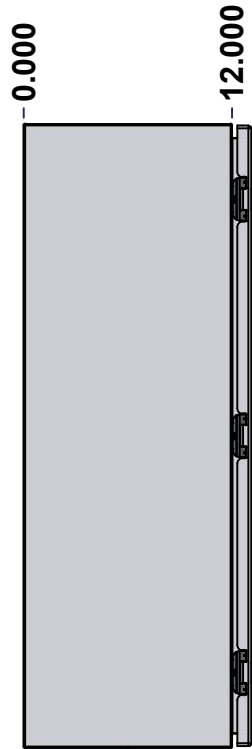

LEFT

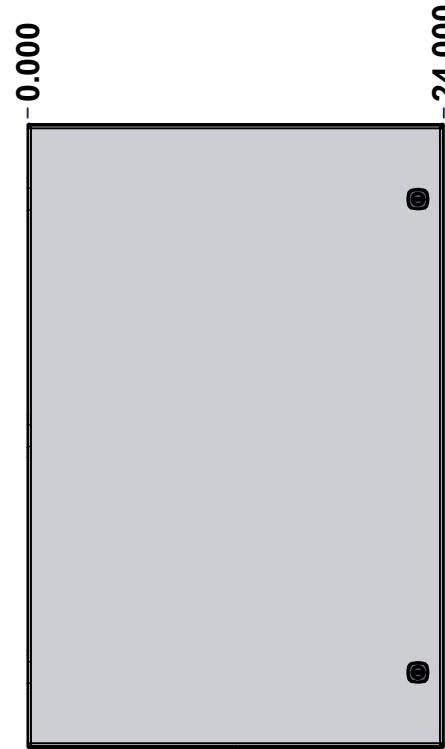

FRONT

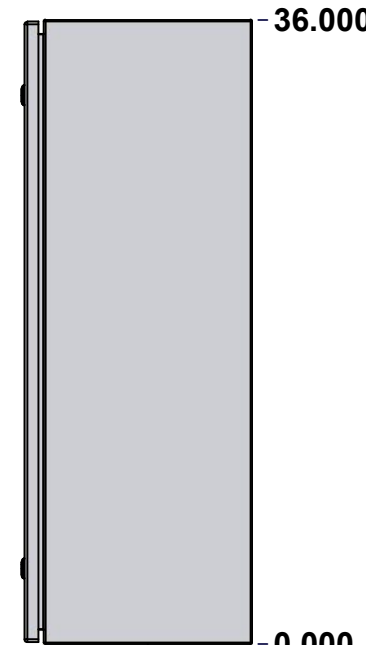

RIGHT

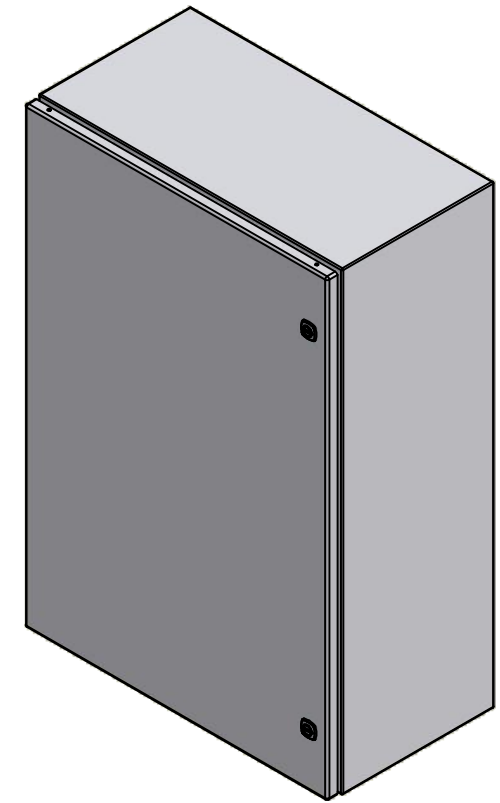

Isometric View

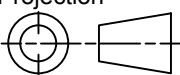

No.	Revisions	Date	By/Par

 Tél: (450) 979-4373 Fax: (450) 979-4626 <a href="http://www.exmweb.com">www.exmweb.com</a>		Flatness Aplatissement Max 3.0mm Projection 
Customer Client	Date	
Drawn By Dessiné Par	BoxCad: BoxCad	Date 11-Sep-19
Material Matière	16 Ga Cold Rolled A1008 CS Type B (1.4mm)	
Color Couleur	Asa-61 Grey	Finish Fini Smooth
Description	Detail Rev.	
5412ES 36" x 24" x 12" Assembly		
Part Number Numéro Pièce	Rev.	1
5412ES362412NOIP	0	9

SEE BILL OF MATERIAL ON LAST PAGE

This drawing is confidential and must not be reproduced or used without the consent of EXM

Ce dessin est confidentiel et ne doit pas être reproduit ou utilisé sans le consentement de EXM

NOTE	
ITEM	DESCRIPTION
1	NEMA 4/12 Enclosure
2	C/W Standard ground studs on box and cover
3	C/W Standard door stiffener
4	W/O Inner panel
5	C/W Standard inner panel mounting studs
6	C/W 880 PP included (Not installed)

No.	Revisions	Date	By/Par

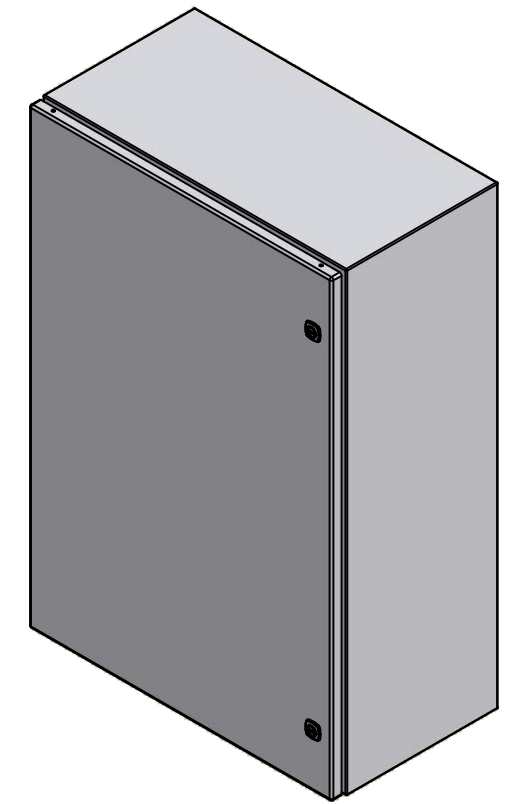

Isometric View



 Tél: (450) 979-4373  
 Fax: (450) 979-4626  
[www.exmweb.com](http://www.exmweb.com)

Flatness / Aplatissement: Max 3.0mm  
 Projection: 

Customer Client	Date
Drawn By / Dessiné Par: BoxCad: BoxCad	Date: 11-Sep-19
Material / Matière: 16 Ga Cold Rolled A1008 CS Type B (1.4mm)	

Color / Couleur: Asa-61 Grey	Finish / Fini: Smooth
Description: 5412ES 36" x 24" x 12" Assembly	Detail Rev.
Part Number / Numéro Pièce: <b>5412ES362412NOIP</b>	Rev. 0

PACKING		
ITEM	QTY	DESCRIPTION
Cardboard sleeve	2	Top and Bottom
Cardboard strip	2	Between back of enclosure and inner panel
Plastic bag	1	To protect cover surface and inside gasket
Plastic strap - Black	2	To Squeeze the 2 cardboard sleeve together
Packaging label	1	White label with product number

Qty	Part Number	Rev	Description
1	880 PP	6	Self Adhesive Print Pocket
1	STK-K-01800	5	5412 ES Accessory Kit
1	5412ES362412NOIPC	0	5412ES 36" x 24" Cover
1	5412ES362412NOIPB	0	5412ES 36" x 24" x 12" Body
3	STK-Q-04050-08	0	M6 x 8mm Hexagon Socket Head Machine Screw
Parts List			

This drawing is confidential and must not be reproduced or used without the consent of EXM

Ce dessin est confidentiel et ne doit pas être reproduit ou utilisé sans le consentement de EXM



TOP



BACK



BOTTOM

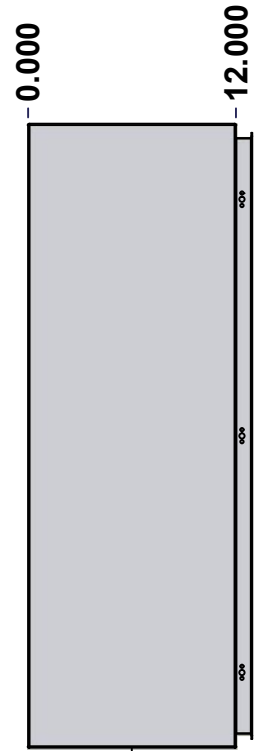

LEFT

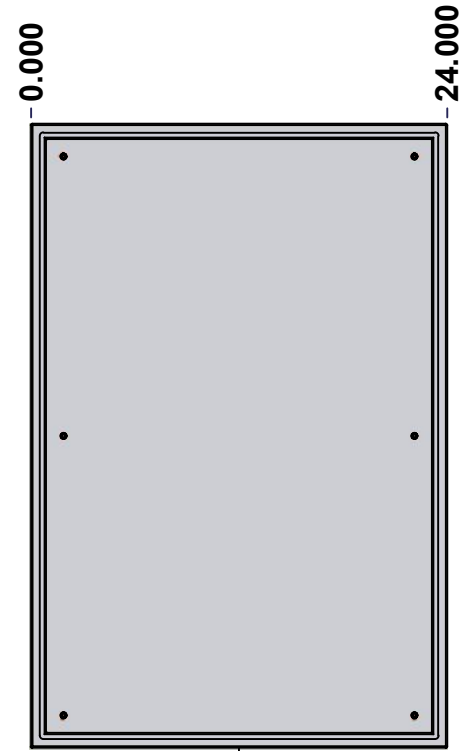

FRONT

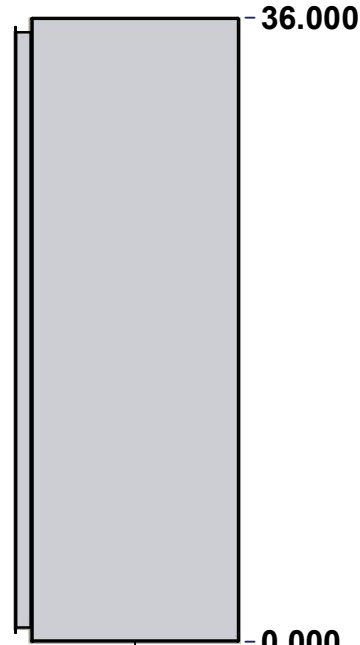

RIGHT

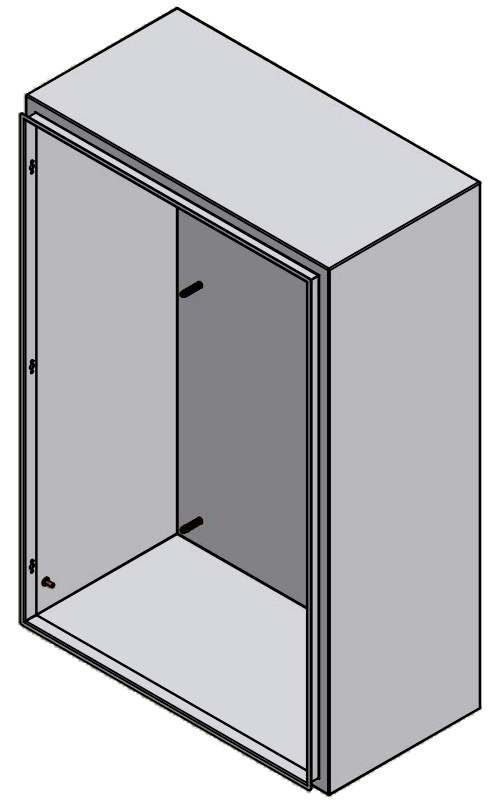

Isometric View

No.	Revisions	Date	By/Par

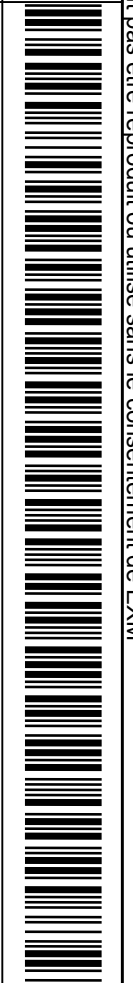

Tél: (450) 979-4373  
 Fax: (450) 979-4626  
[www.exmweb.com](http://www.exmweb.com)

Flatness  
Aplatissement  
Max 3.0mm  
Projection

Customer Client	Date
Drawn By Dessiné Par BoxCad: BoxCad	Date 11-Sep-19
Material Matière 16 Ga Cold Rolled A1008 CS Type B (1.4mm)	
Color Couleur Asa-61 Grey	Finish Fini Smooth
Description 5412ES 36" x 24" x 12" Body	Detail Rev.
Part Number Numéro Pièce <b>5412ES362412NOIPB</b>	Rev. <b>0</b>

SEE BILL OF MATERIAL ON LAST PAGE

3  
9

This drawing is confidential and must not be reproduced or used without the consent of EXM

Ce dessin est confidentiel et ne doit pas être reproduit ou utilisé sans le consentement de EXM

<b>STANDARD FEATURES ARE NOT LISTED IN THIS HOLE TABLE</b>			
<b>HOLE TABLE - LEFT VIEW (CUSTOM FEATURE ONLY)</b>			
CUT-OUT	XDIM	YDIM	DESCRIPTION
1	10.500	2.000	GND STUD M6 x 16mm (Inside)

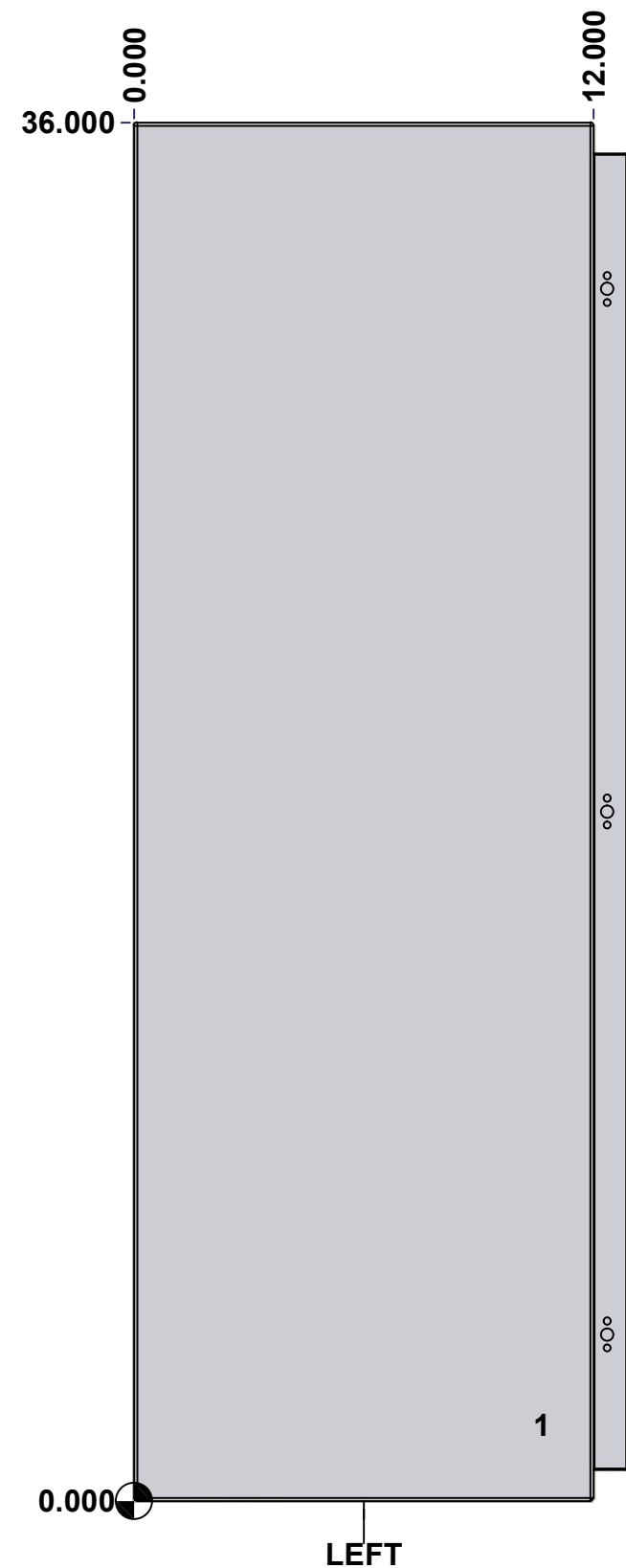

	Description	Status	
	5412ES 36" x 24" x 12" Body	(NULL)	
	Part Number Numéro Pièce	Rev.	
	<b>5412ES362412NOIPB</b>	<b>0</b>	4/9

This drawing is confidential and must not be reproduced or used without the consent of EXM

Ce dessin est confidentiel et ne doit pas être reproduit ou utilisé sans le consentement de EXM

**STANDARD FEATURES ARE NOT LISTED IN THIS HOLE TABLE**

**HOLE TABLE - BACK VIEW (CUSTOM FEATURE ONLY)**

CUT-OUT	XDIM	YDIM	DESCRIPTION
1	1.875	1.875	IP STUD M8 x 35mm (Inside)
2	1.875	34.125	IP STUD M8 x 35mm (Inside)
3	22.125	34.125	IP STUD M8 x 35mm (Inside)
4	22.125	1.875	IP STUD M8 x 35mm (Inside)
5	1.875	18.000	IP STUD M8 x 35mm (Inside)
6	22.125	18.000	IP STUD M8 x 35mm (Inside)
-----			
7	23.250	0.750	RND Ø0.390
8	23.250	35.250	RND Ø0.390
9	0.750	35.250	RND Ø0.390
10	0.750	0.750	RND Ø0.390

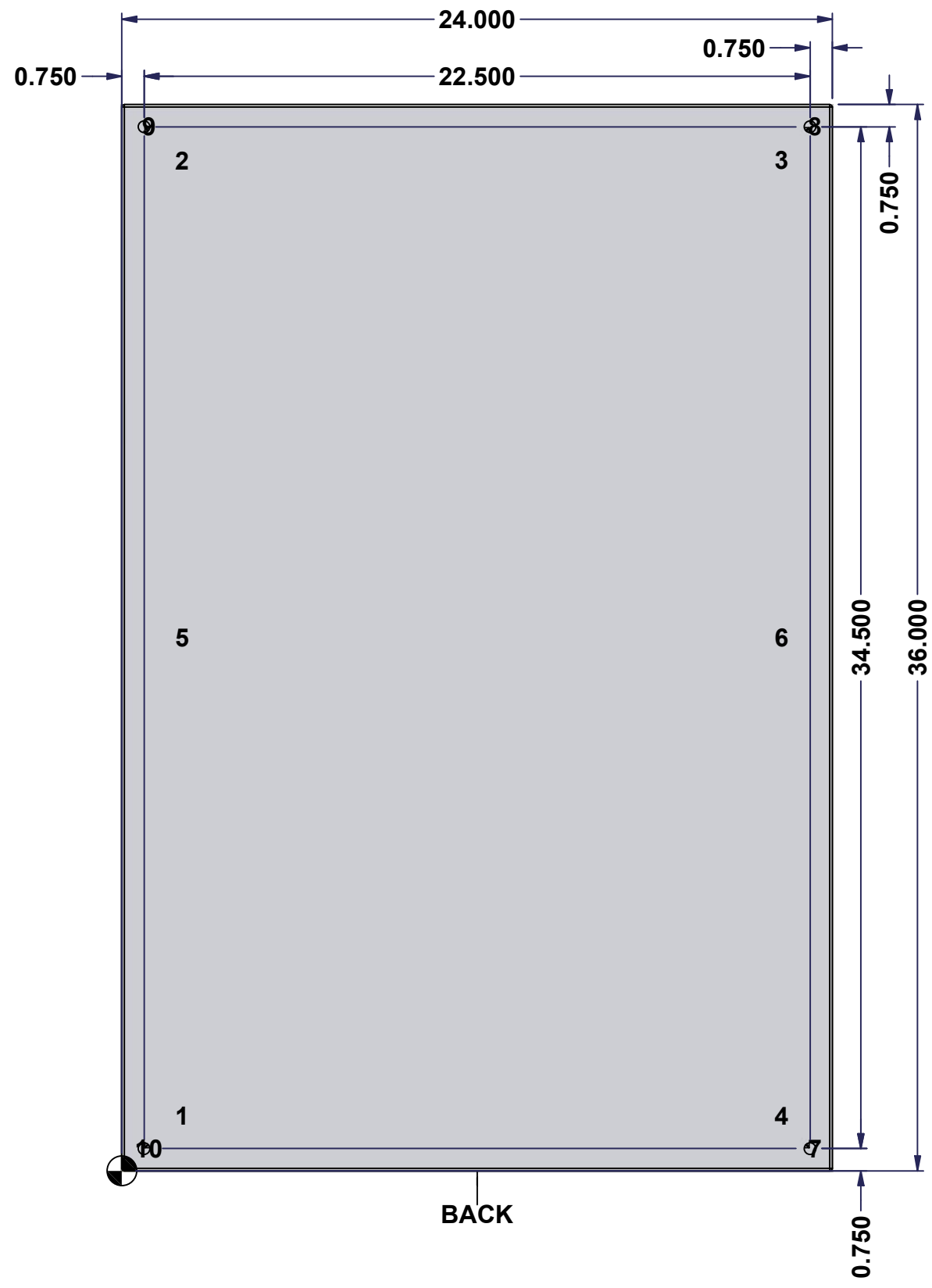

BACK

	Description	Status	
	5412ES 36" x 24" x 12" Body	(NULL)	
	Part Number Numéro Pièce	Rev.	
	<b>5412ES362412NOIPB</b>	<b>0</b>	5 9

This drawing is confidential and must not be reproduced or used without the consent of EXM

Ce dessin est confidentiel et ne doit pas être reproduit ou utilisé sans le consentement de EXM

No.	Revisions	Date	By/Par

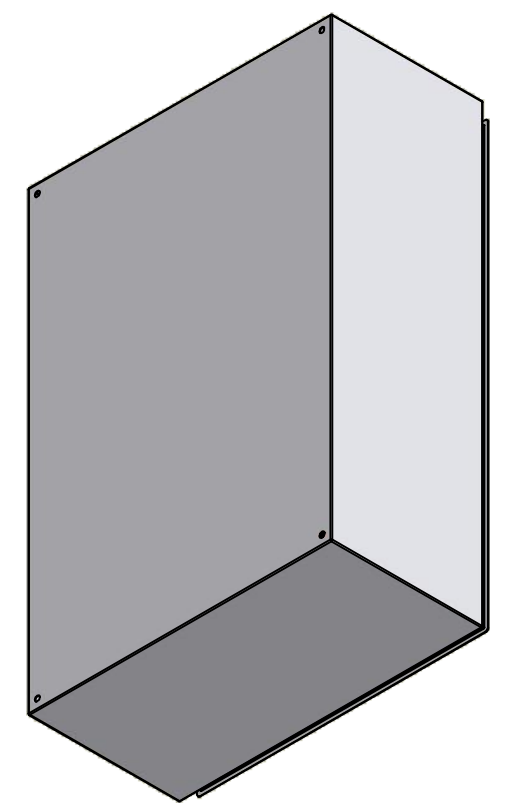

Isometric View

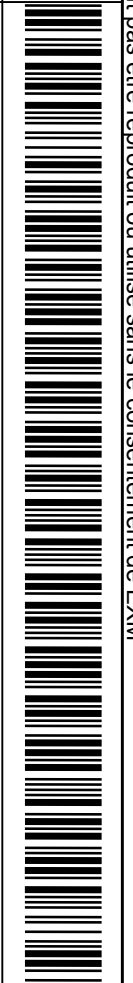

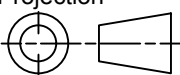
 Tél: (450) 979-4373 Fax: (450) 979-4626 <a href="http://www.exmweb.com">www.exmweb.com</a>	Flatness Aplatissement	Max 3.0mm
	Projection	
Customer Client	Date	
Drawn By Dessiné Par	BoxCad: BoxCad	Date 11-Sep-19
Material Matière	16 Ga Cold Rolled A1008 CS Type B (1.4mm)	
Color Couleur	Asa-61 Grey	Finish Fini Smooth
Description	Detail Rev.	
5412ES 36" x 24" x 12" Body		
Part Number Numéro Pièce	Rev.	6
<b>5412ES362412NOIPB</b>	<b>0</b>	9

Qty	Part Number	Rev	Description
1	STK-Q-16080	0	Ground Stud M6 x 16mm
1	STK-P-02400S	0	Powder Paint (Asa-61 Grey / Smooth)
6	STK-Q-16005	1	Stud M8 x 35 (No Paint Cap Required)
1	5412ES362412NOIPB-P	0	5412ES 36" x 24" x 12" Body Part
Parts List			

This drawing is confidential and must not be reproduced or used without the consent of EXM

Ce dessin est confidentiel et ne doit pas être reproduit ou utilisé sans le consentement de EXM

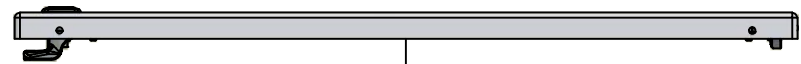

TOP

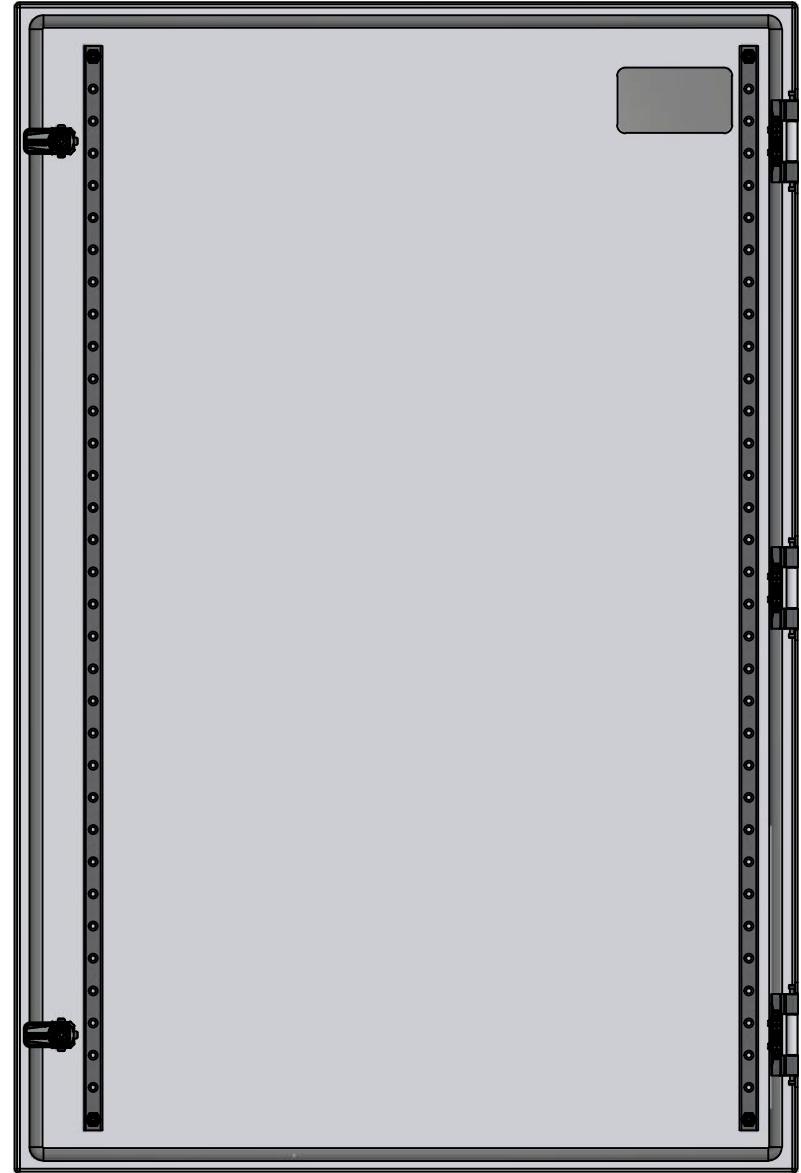

BACK



BOTTOM

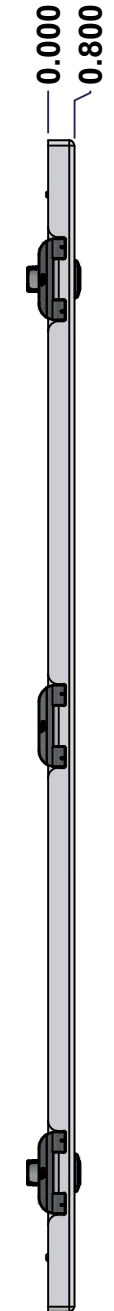

LEFT

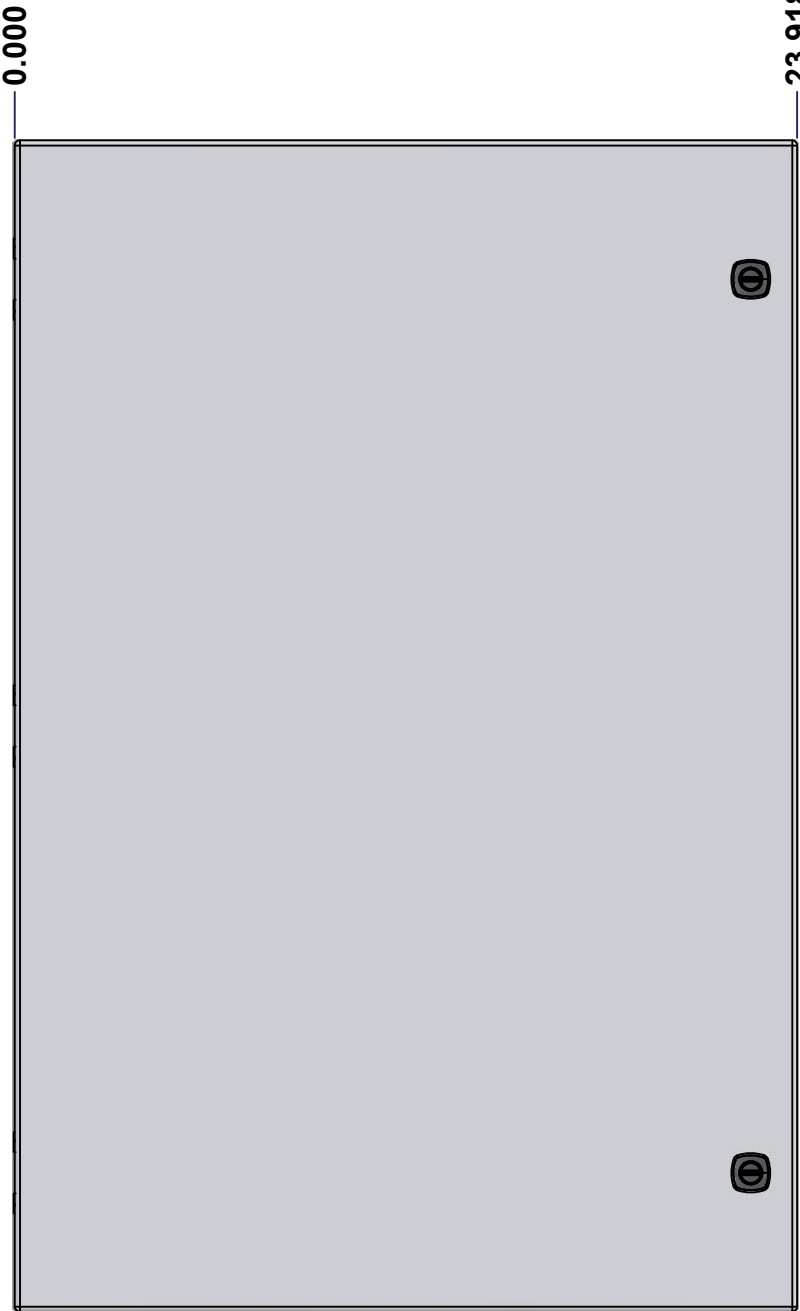

FRONT

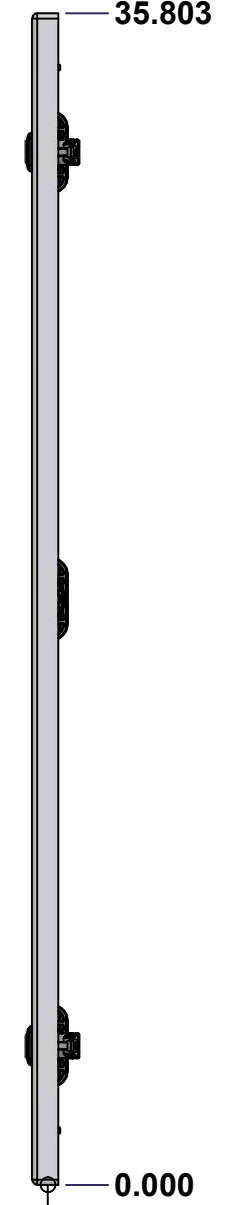

RIGHT

No.	Revisions	Date	By/Par

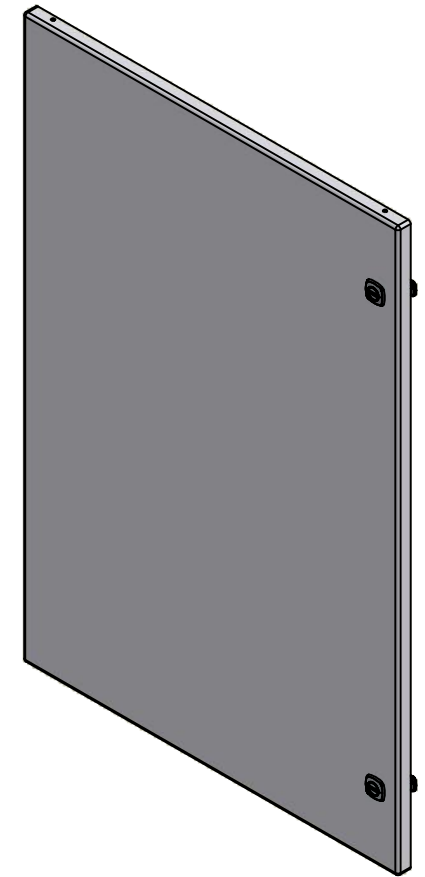

Isometric View



Tél: (450) 979-4373  
 Fax: (450) 979-4626  
[www.exmweb.com](http://www.exmweb.com)

Flatness  
Aplatissement  
Max 3.0mm  
Projection

Customer Client	Date
Drawn By / Dessiné Par: BoxCad: BoxCad	Date: 11-Sep-19
Material / Matière: 14 Ga Cold Rolled A1008 CS Type B (1.7mm)	
Color / Couleur: Asa-61 Grey	Finish / Fini: Smooth
Description: 5412ES 36" x 24" Cover	Detail Rev.
Part Number / Numéro Pièce: 5412ES362412NOIPC	Rev. 7
SEE BILL OF MATERIAL ON LAST PAGE	0 9

SEE BILL OF MATERIAL ON LAST PAGE

This drawing is confidential and must not be reproduced or used without the consent of EXM

Ce dessin est confidentiel et ne doit pas être reproduit ou utilisé sans le consentement de EXM

**STANDARD FEATURES ARE NOT LISTED IN THIS HOLE TABLE**

**HOLE TABLE - FRONT VIEW (CUSTOM FEATURE ONLY)**

CUT-OUT	XDIM	YDIM	DESCRIPTION
1	1.486	1.661	STUD M6 x 18mm (Inside)
2	1.486	34.142	STUD M6 x 18mm (Inside)
3	21.517	34.142	STUD M6 x 18mm (Inside)
4	21.517	1.661	STUD M6 x 18mm (Inside)
-----			
5	3.750	32.803	LABEL_EXM (Inside)
6	22.494	31.553	LOCK 880 SCQ4-SL @ 0.0°
7	22.494	4.250	LOCK 880 SCQ4-SL @ 0.0°

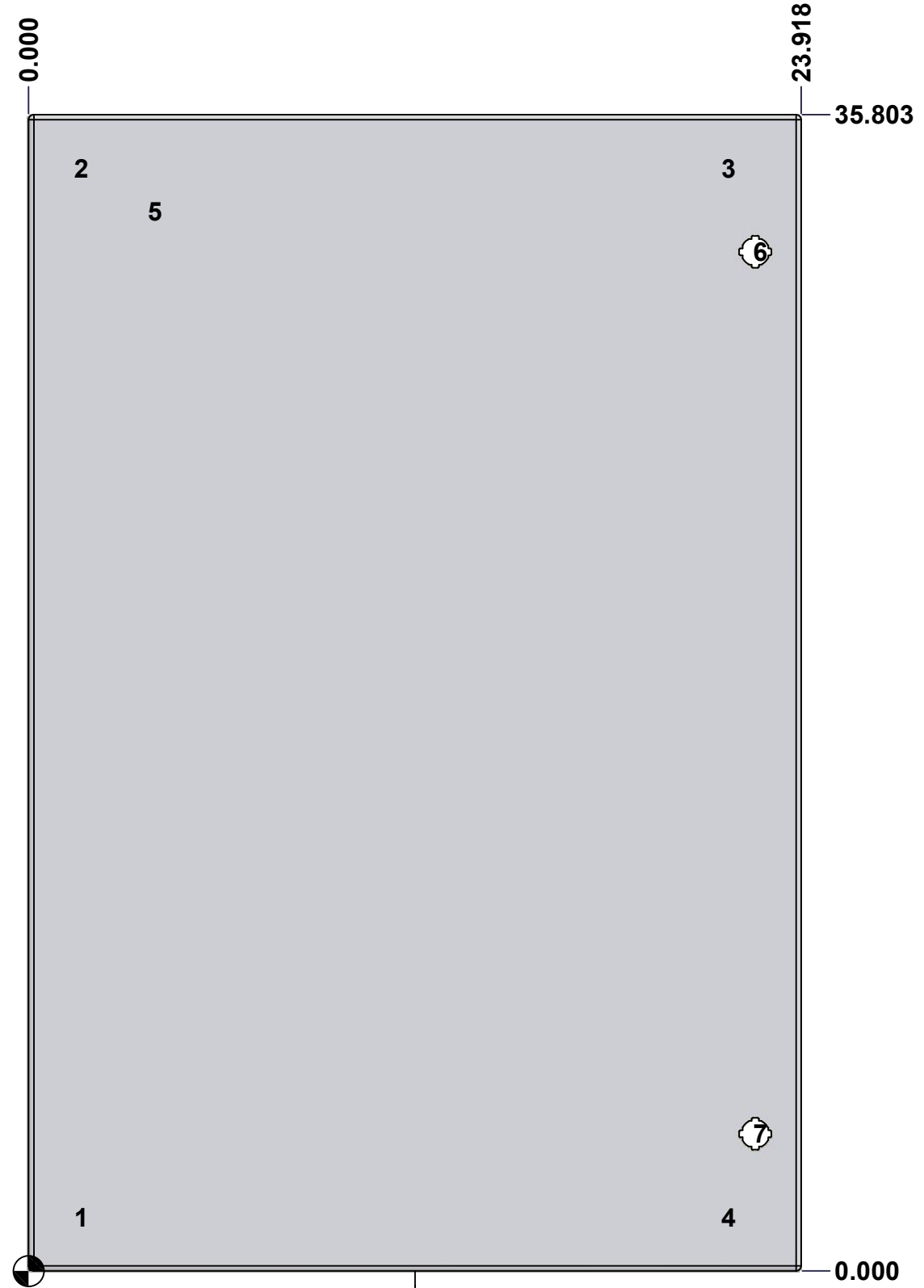

FRONT

	Description	Status
	5412ES 36" x 24" Cover	(NULL)
	Part Number Numéro Pièce	Rev.
	<b>5412ES362412NOIPC</b>	<b>0</b> / 8 / 9



This drawing is confidential and must not be reproduced or used without the consent of EXM

Ce dessin est confidentiel et ne doit pas être reproduit ou utilisé sans le consentement de EXM

No.	Revisions	Date	By/Par

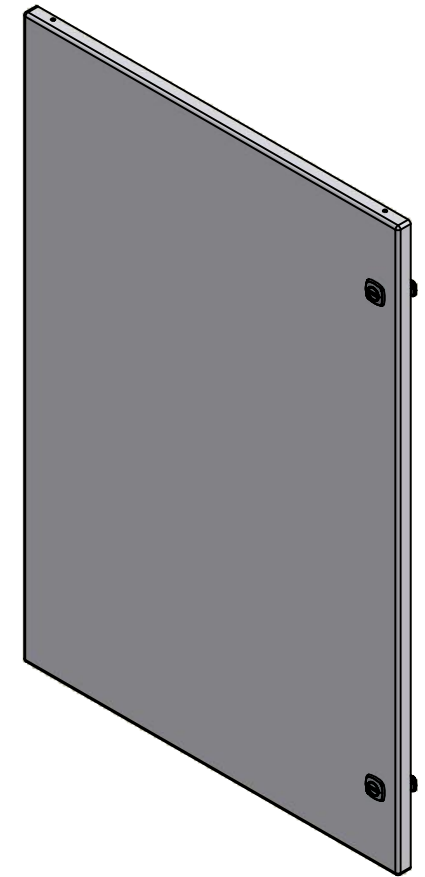

Isometric View



 Tél: (450) 979-4373  
 Fax: (450) 979-4626  
[www.exmweb.com](http://www.exmweb.com)

Flatness / Aplatissement: Max 3.0mm  
 Projection: 

Customer Client	Date
Drawn By / Dessiné Par: BoxCad: BoxCad	Date: 11-Sep-19
Material / Matière: 14 Ga Cold Rolled A1008 CS Type B (1.7mm)	

Color / Couleur: Asa-61 Grey	Finish / Fini: Smooth
Description: 5412ES 36" x 24" Cover	
Detail Rev.	

Part Number / Numéro Pièce: <b>5412ES362412NOIPC</b>	Rev. 0	9
--	--------	---

Qty	Part Name	Rev	Description
1	STK-S-00100	0	3.5" x 2" Silver Milar Flexcon Sticker
1	STK-P-02400S	0	Powder Paint (Asa-61 Grey / Smooth)
2	STK-Q-46020-36	5	5412 ES Vertical Door Stiffener 36"
4	STK-Q-16055	1	M6 x 18mm Stud (No Paint Cap Required)
1	5412ES362412NOIPG	0	5412ES 36" x 24" Cover Gasket Part
1	5412ES362412NOIPC-P	0	5412ES 36" x 24" Cover Part
3	STK-K-09800	10	5412 ES Hinge with 2 Captive Hinge Pins
2	STK-K-12500	16	5412 ES 1/4 Turn Lock
4	STK-Q-07220	1	M6 Nylon Insert Lock Nut
Parts List			