

This drawing is confidential and must not be reproduced or used without the consent of EXM

Ce dessin est confidentiel et ne doit pas être reproduit ou utilisé sans le consentement de EXM

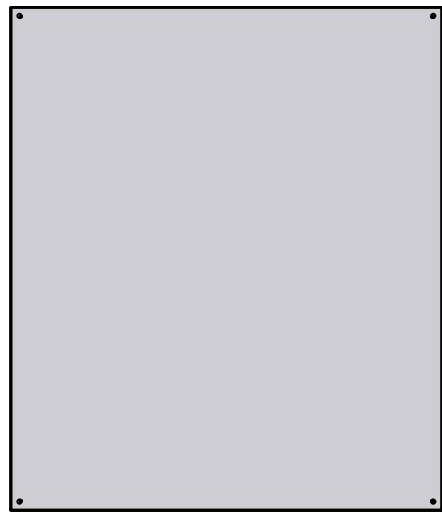

TOP



BACK

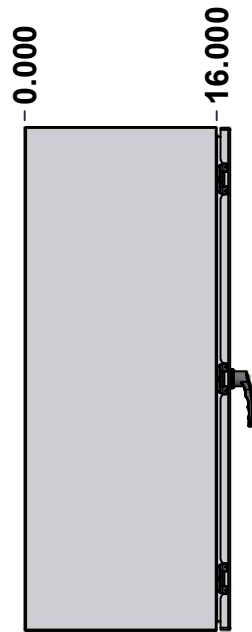

LEFT

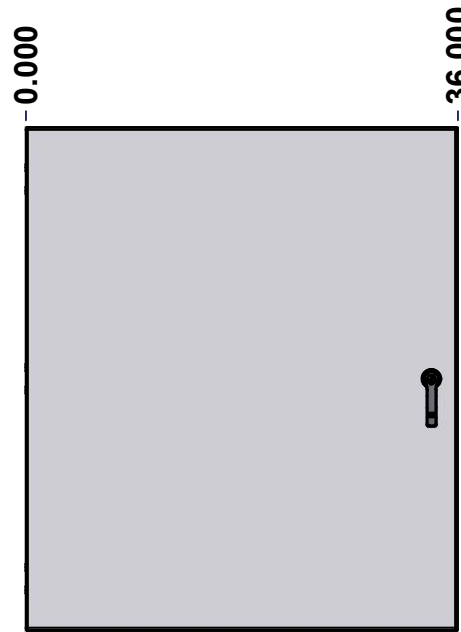

FRONT

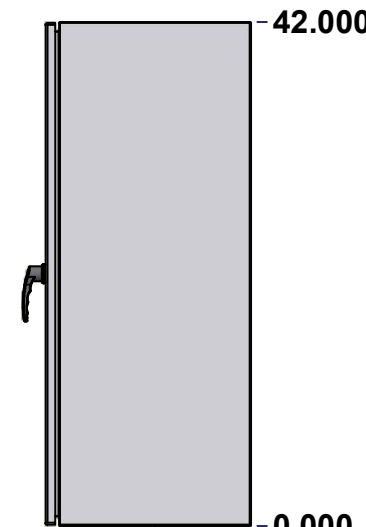

RIGHT

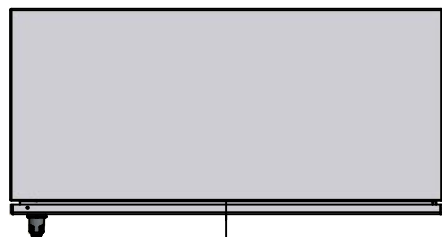

BOTTOM

No.	Revisions	Date	By/Par

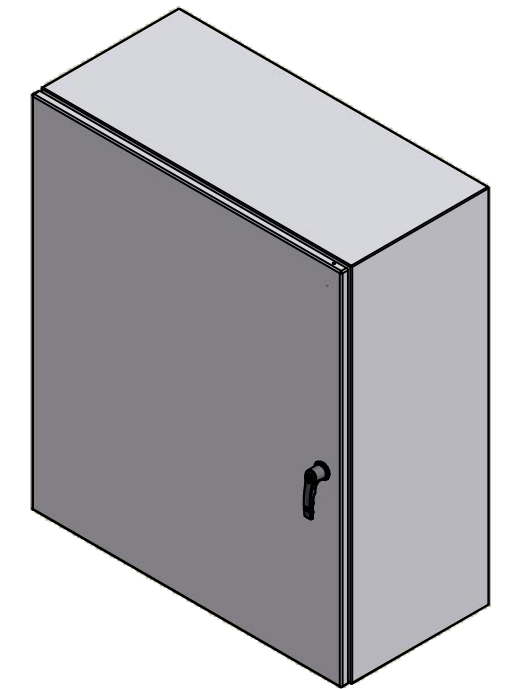

Isometric View



Tél: (450) 979-4373  
 Fax: (450) 979-4626  
[www.exmweb.com](http://www.exmweb.com)

Flatness  
Aplatissement

Max 3.0mm

Projection



Customer Client	Date
Drawn By Dessiné Par BoxCad: BoxCad	Date 12-Sep-19
Material Matière 14 Ga Cold Rolled A1008 CS Type B (1.7mm)	

Color Couleur Asa-61 Grey	Finish Fini Smooth
------------------------------	-----------------------

Description 5412ES 42" x 36" x 16" Assembly	Detail Rev.
--	-------------

Part Number Numéro Pièce 5412ES423616NOIP	Rev. 0	1	9
--	--------	---	---

SEE BILL OF MATERIAL ON LAST PAGE

This drawing is confidential and must not be reproduced or used without the consent of EXM

Ce dessin est confidentiel et ne doit pas être reproduit ou utilisé sans le consentement de EXM

NOTE	
ITEM	DESCRIPTION
1	NEMA 4/12 Enclosure
2	C/W Standard ground studs on box and cover
3	C/W Standard door stiffener
4	W/O Inner panel
5	C/W Standard inner panel mounting studs
6	C/W 880 PP included (Not installed)

No.	Revisions	Date	By/Par

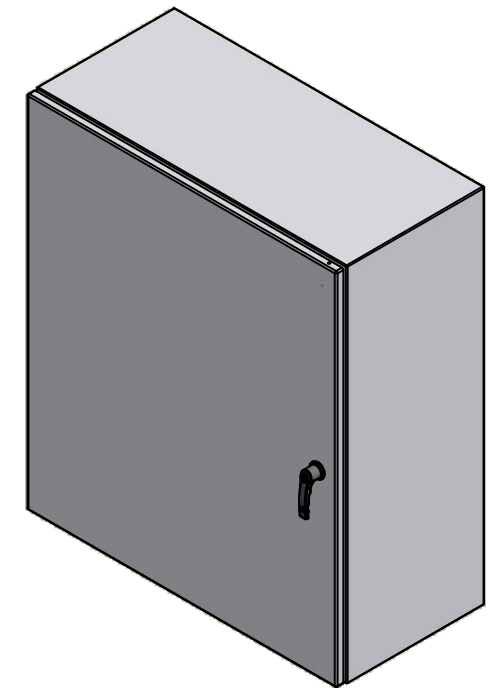

Isometric View

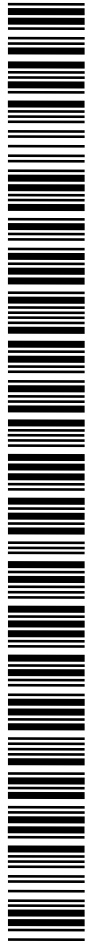

PACKING		
ITEM	QTY	DESCRIPTION
Cardboard sleeve	2	Top and Bottom
Cardboard strip	2	Between back of enclosure and inner panel
Plastic bag	1	To protect cover surface and inside gasket
Cardboard corner	4	To reinforced for the plastic strap tightening
Plastic strap - Black	2	To Squeeze the 2 cardboard sleeve together
Packaging label	3	White label with PN
Plastic strap- Green	2	To secure the enclosure to the wood pallet
Wood Pallet	1	2" deeper and 3" larger than enclosure size

1	880 PP	6	Self Adhesive Print Pocket
1	STK-K-01800	5	5412 ES Accessory Kit
1	5412ES423616NOIPC	0	5412ES 42" x 36" Cover
1	5412ES423616NOIPB	0	5412ES 42" x 36" x 16" Body
3	STK-Q-04050-08	0	M6 x 8mm Hexagon Socket Head Machine Screw
Qty	Part Number	Rev	Description
Parts List			

	Tél: (450) 979-4373 Fax: (450) 979-4626 <a href="http://www.exmweb.com">www.exmweb.com</a>	Flatness Aplatissement Max 3.0mm
	Projection 	Customer Client Date
Drawn By Dessiné Par	BoxCad: BoxCad	Date 12-Sep-19
Material Matière	14 Ga Cold Rolled A1008 CS Type B (1.7mm)	
Color Couleur	Asa-61 Grey	Finish Fini Smooth
Description 5412ES 42" x 36" x 16" Assembly		Detail Rev.
Part Number Numéro Pièce <b>5412ES423616NOIP</b>		Rev. 0 2 9

This drawing is confidential and must not be reproduced or used without the consent of EXM

Ce dessin est confidentiel et ne doit pas être reproduit ou utilisé sans le consentement de EXM



TOP

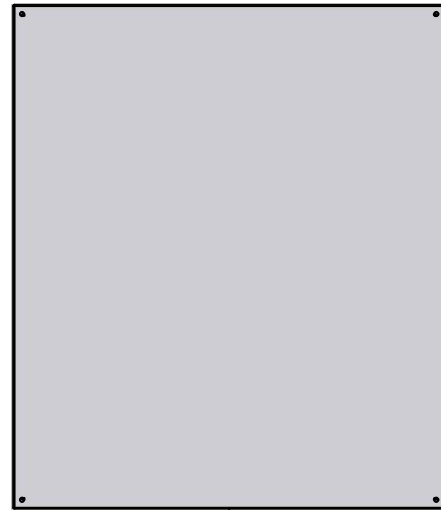

BACK

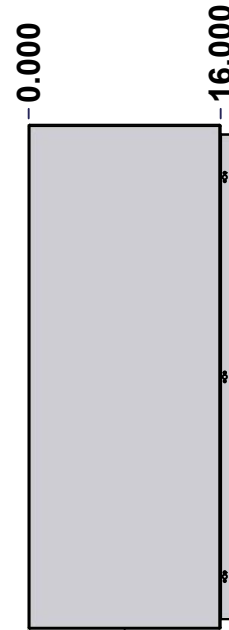

LEFT

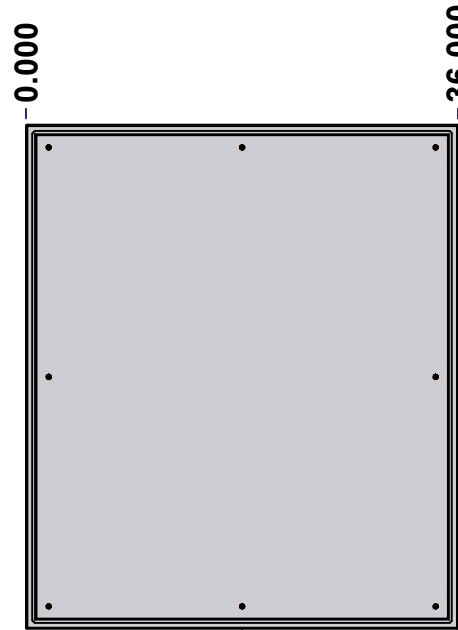

FRONT

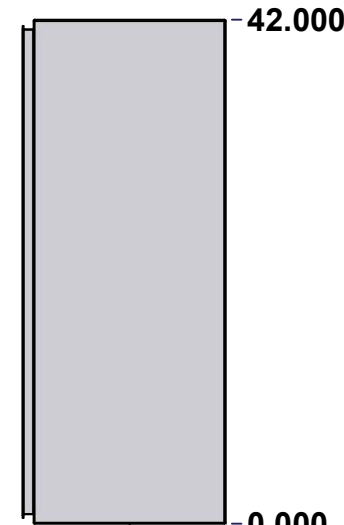

RIGHT



BOTTOM

No.	Revisions	Date	By/Par

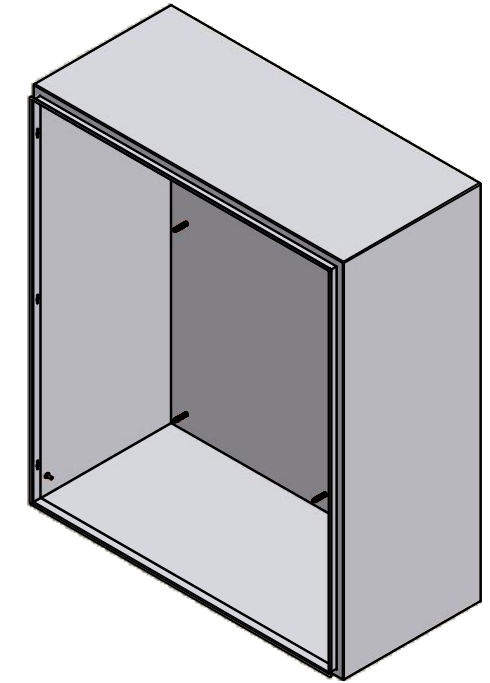

Isometric View



Tél: (450) 979-4373  
 Fax: (450) 979-4626  
[www.exmweb.com](http://www.exmweb.com)

Flatness  
Aplatissement

Max 3.0mm

Projection

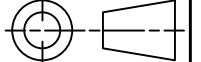

Customer Client	Date
Drawn By Dessiné Par BoxCad: BoxCad	Date 12-Sep-19
Material Matière 14 Ga Cold Rolled A1008 CS Type B (1.7mm)	
Color Couleur Asa-61 Grey	Finish Fini Smooth
Description 5412ES 42" x 36" x 16" Body	Detail Rev.
Part Number Numéro Pièce <b>5412ES423616NOIPB</b>	Rev. 3 <b>0</b>

SEE BILL OF MATERIAL ON LAST PAGE

This drawing is confidential and must not be reproduced or used without the consent of EXM

Ce dessin est confidentiel et ne doit pas être reproduit ou utilisé sans le consentement de EXM

<b>STANDARD FEATURES ARE NOT LISTED IN THIS HOLE TABLE</b>			
<b>HOLE TABLE - LEFT VIEW (CUSTOM FEATURE ONLY)</b>			
CUT-OUT	XDIM	YDIM	DESCRIPTION
1	14.500	2.000	GND STUD M6 x 16mm (Inside)

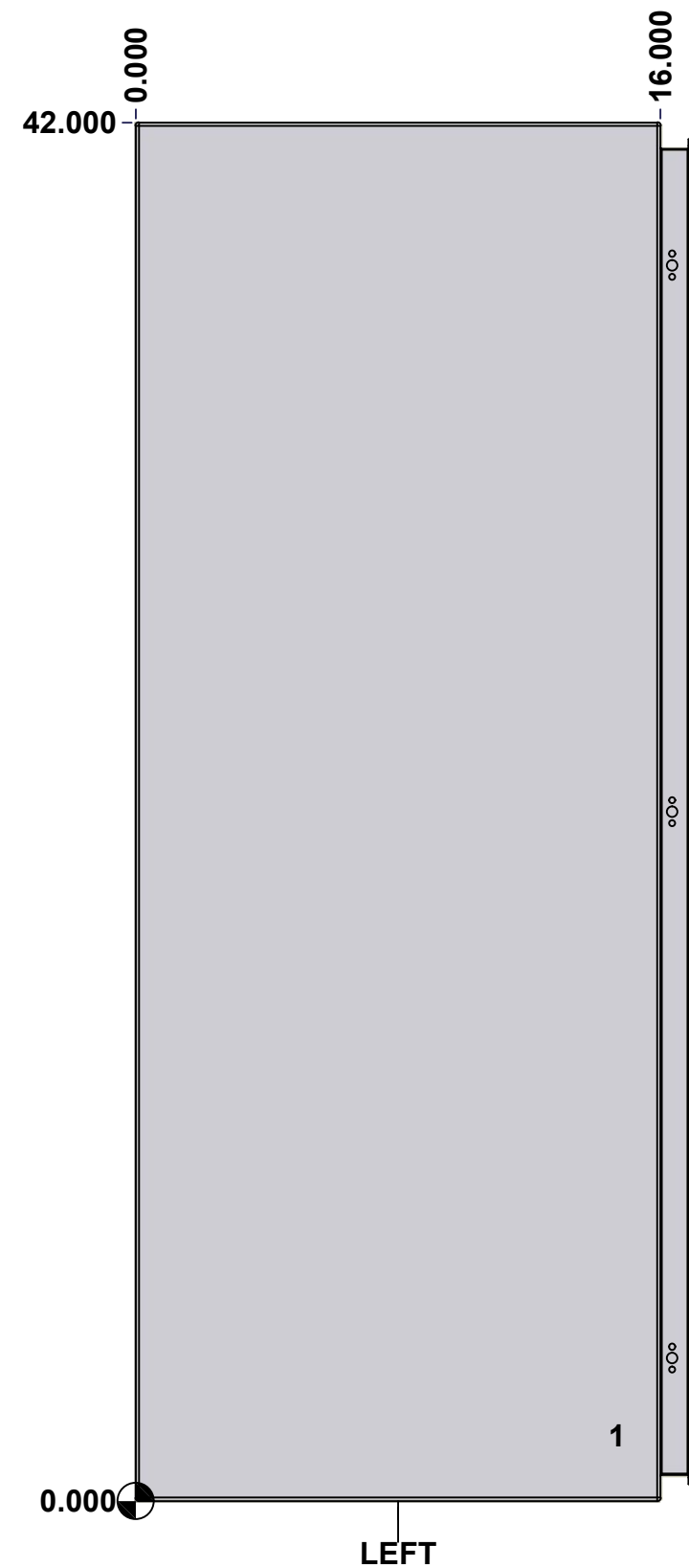

	Description	Status	
	5412ES 42" x 36" x 16" Body	(NULL)	
	Part Number Numéro Pièce	Rev.	
	<b>5412ES423616NOIPB</b>	<b>0</b>	4 9

This drawing is confidential and must not be reproduced or used without the consent of EXM

Ce dessin est confidentiel et ne doit pas être reproduit ou utilisé sans le consentement de EXM

**STANDARD FEATURES ARE NOT LISTED IN THIS HOLE TABLE**

**HOLE TABLE - BACK VIEW (CUSTOM FEATURE ONLY)**

CUT-OUT	XDIM	YDIM	DESCRIPTION
1	1.875	1.875	IP STUD M8 x 35mm (Inside)
2	1.875	40.125	IP STUD M8 x 35mm (Inside)
3	34.125	40.125	IP STUD M8 x 35mm (Inside)
4	34.125	1.875	IP STUD M8 x 35mm (Inside)
5	1.875	21.000	IP STUD M8 x 35mm (Inside)
6	34.125	21.000	IP STUD M8 x 35mm (Inside)
7	18.000	1.875	IP STUD M8 x 35mm (Inside)
8	18.000	40.125	IP STUD M8 x 35mm (Inside)
-----			
9	35.250	0.750	RND Ø0.390
10	35.250	41.250	RND Ø0.390
11	0.750	41.250	RND Ø0.390
12	0.750	0.750	RND Ø0.390

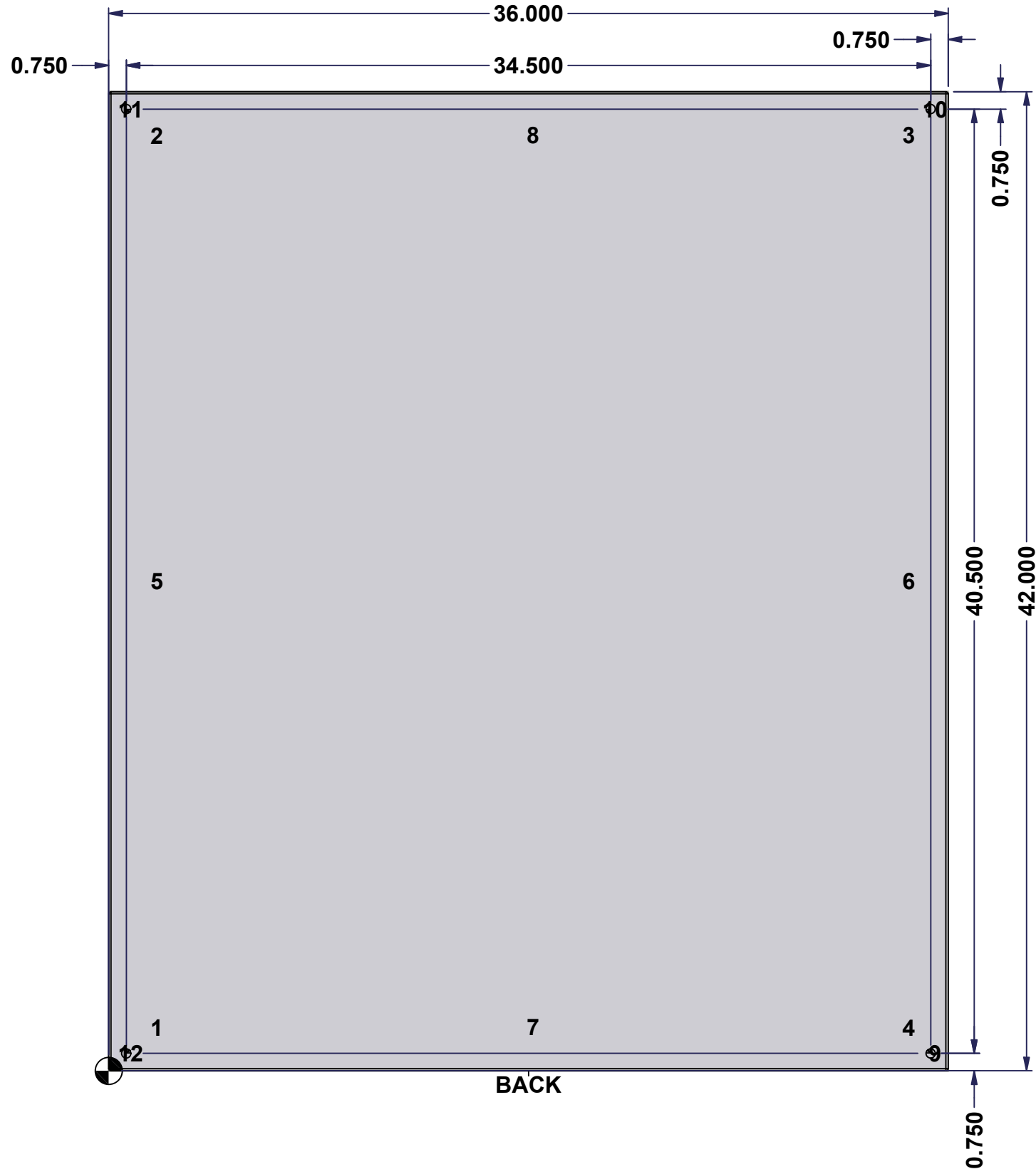

	Description	Status
	5412ES 42" x 36" x 16" Body	(NULL)
	Part Number	Rev.
	Numéro Pièce	5
	<b>5412ES423616NOIPB</b>	<b>0</b>
		9

This drawing is confidential and must not be reproduced or used without the consent of EXM

Ce dessin est confidentiel et ne doit pas être reproduit ou utilisé sans le consentement de EXM

No.	Revisions	Date	By/Par

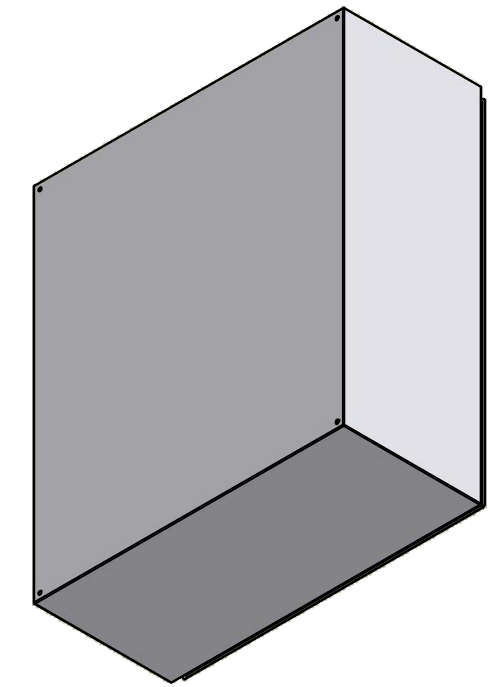

Isometric View

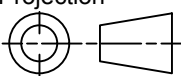

 Tél: (450) 979-4373 Fax: (450) 979-4626 <a href="http://www.exmweb.com">www.exmweb.com</a>		Flatness Aplatissement Max 3.0mm
Customer Client		Projection 
Drawn By / Dessiné Par: BoxCad: BoxCad		Date: 12-Sep-19
Material / Matière: 14 Ga Cold Rolled A1008 CS Type B (1.7mm)		
Color / Couleur: Asa-61 Grey	Finish / Fini: Smooth	
Description: 5412ES 42" x 36" x 16" Body		Detail Rev.
Part Number / Numéro Pièce: <b>5412ES423616NOIPB</b>		Rev. 6 0 9

Qty	Part Number	Rev	Description
1	STK-Q-16080	0	Ground Stud M6 x 16mm
1	STK-P-02400S	0	Powder Paint (Asa-61 Grey / Smooth)
8	STK-Q-16005	1	Stud M8 x 35 (No Paint Cap Required)
1	5412ES423616NOIPB-P	0	5412ES 42" x 36" x 16" Body Part
Parts List			

This drawing is confidential and must not be reproduced or used without the consent of EXM

Ce dessin est confidentiel et ne doit pas être reproduit ou utilisé sans le consentement de EXM

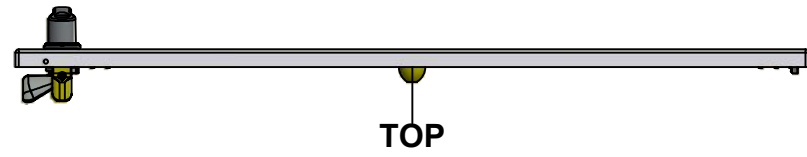

TOP

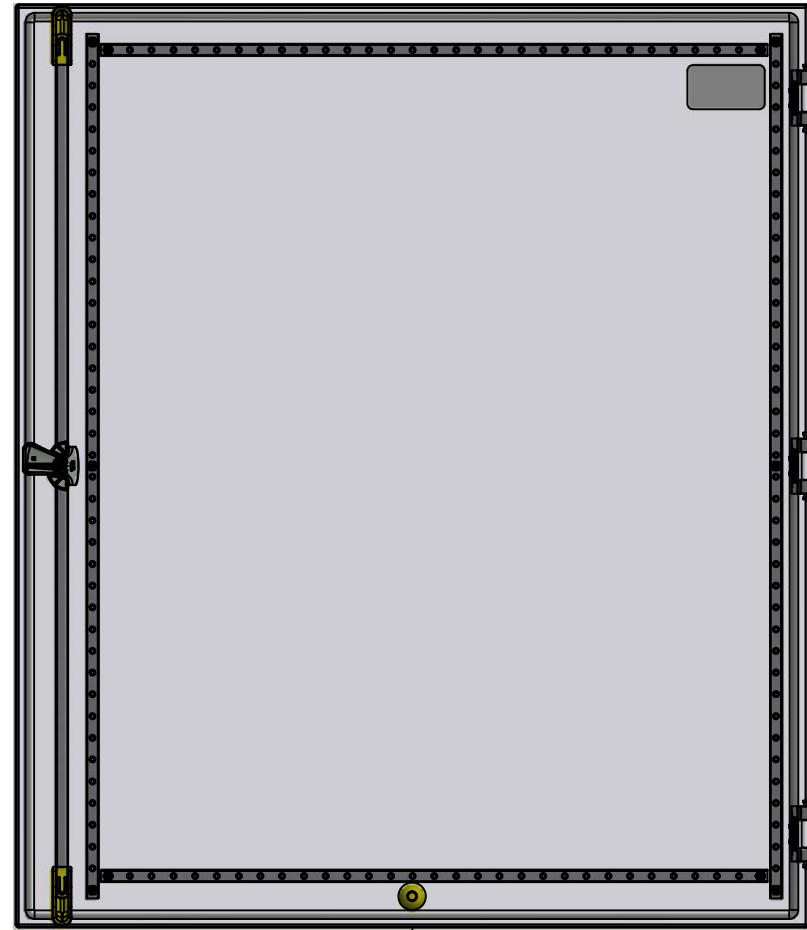

BACK

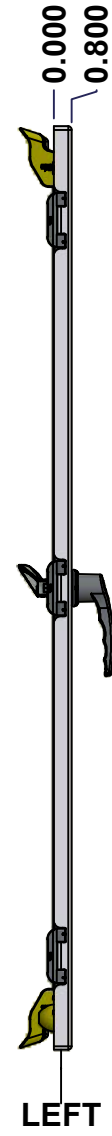

LEFT

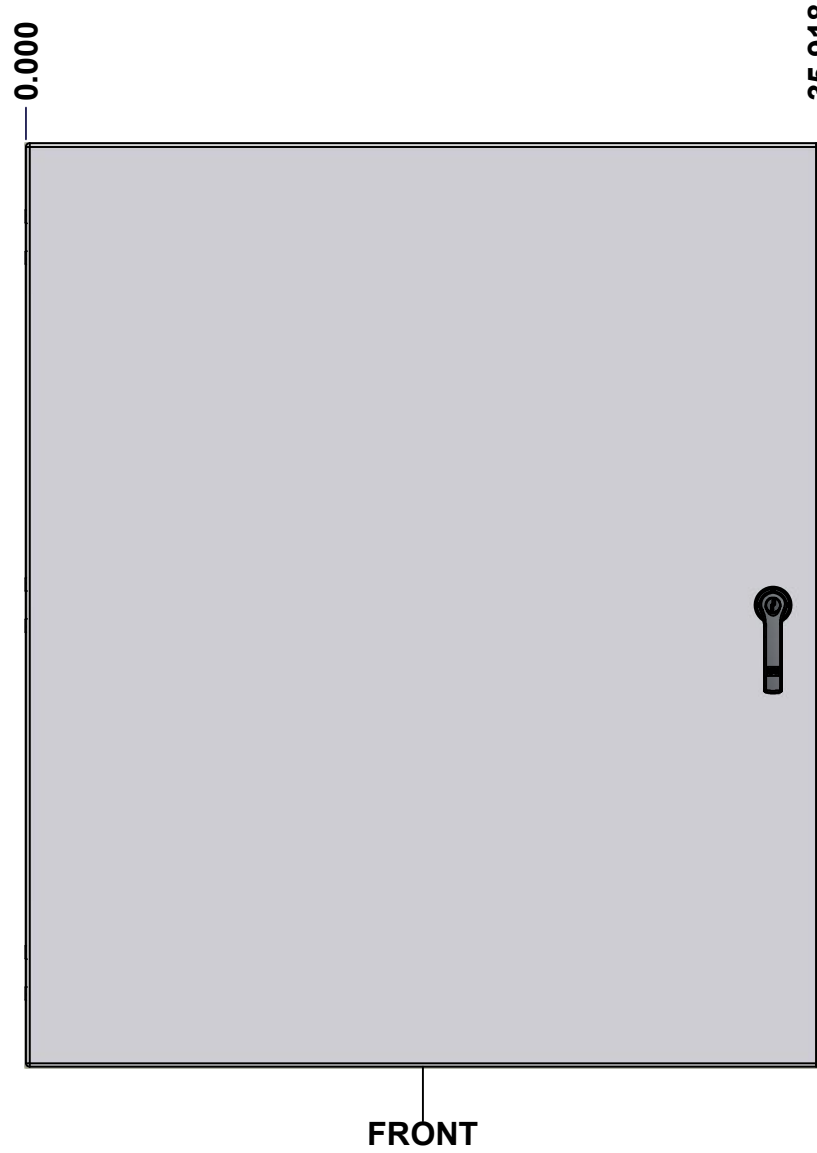

FRONT

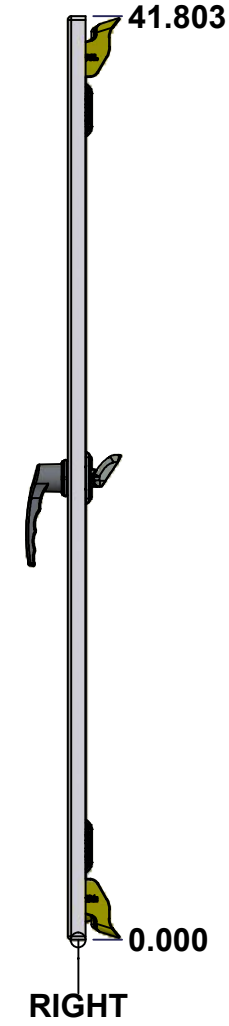

RIGHT

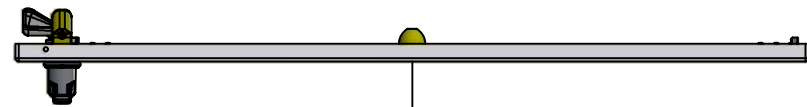

BOTTOM

0.000  
0.800  
0.000  
35.918  
41.803  
0.000

No.	Revisions	Date	By/Par

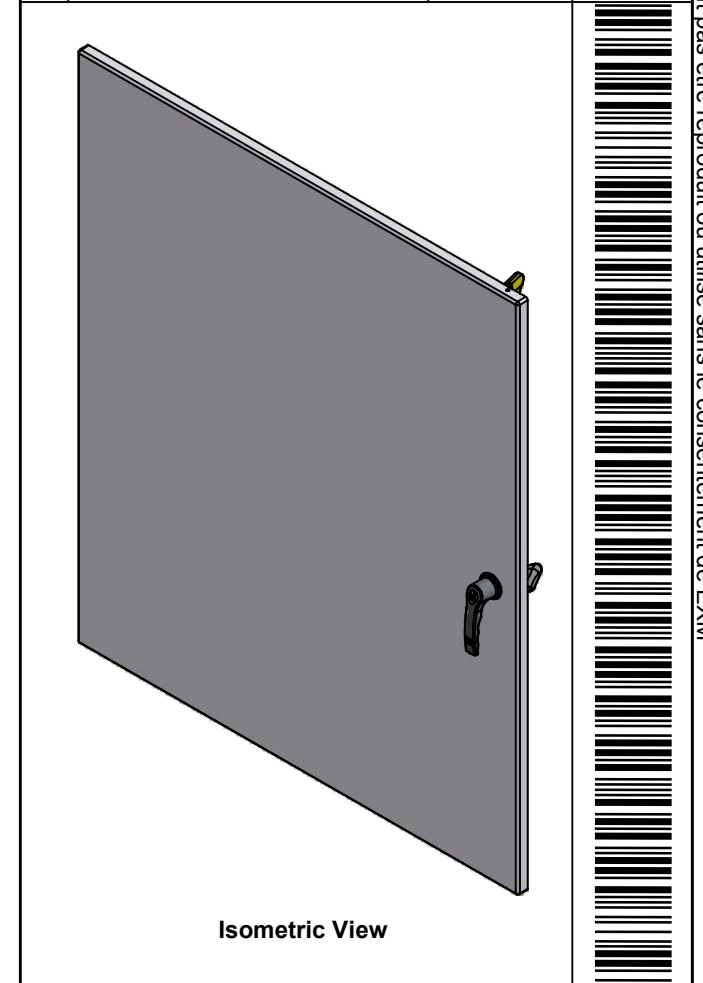

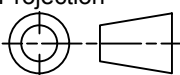
 Tél: (450) 979-4373 Fax: (450) 979-4626 <a href="http://www.exmweb.com">www.exmweb.com</a>		Flatness Aplatissement Max 3.0mm Projection 
Customer Client	Date	
Drawn By Dessiné Par	BoxCad: BoxCad	Date 12-Sep-19
Material Matière	14 Ga Cold Rolled A1008 CS Type B (1.7mm)	
Color Couleur	Asa-61 Grey	Finish Fini Smooth
Description	Detail Rev.	
5412ES 42" x 36" Cover		
Part Number Numéro Pièce	Rev.	7
5412ES423616NOIPC	0	9

SEE BILL OF MATERIAL ON LAST PAGE

This drawing is confidential and must not be reproduced or used without the consent of EXM

Ce dessin est confidentiel et ne doit pas être reproduit ou utilisé sans le consentement de EXM

**STANDARD FEATURES ARE NOT LISTED IN THIS HOLE TABLE**

**HOLE TABLE - FRONT VIEW (CUSTOM FEATURE ONLY)**

CUT-OUT	XDIM	YDIM	DESCRIPTION
1	1.486	1.709	STUD M6 x 18mm (Inside)
2	1.486	40.094	STUD M6 x 18mm (Inside)
3	32.423	40.094	STUD M6 x 18mm (Inside)
4	32.423	1.709	STUD M6 x 18mm (Inside)
5	1.486	20.902	STUD M6 x 18mm (Inside)
6	32.423	20.902	STUD M6 x 18mm (Inside)
7	2.191	2.350	STUD M6 x 18mm (Inside)
8	2.191	39.733	STUD M6 x 18mm (Inside)
9	31.718	39.733	STUD M6 x 18mm (Inside)
10	31.718	2.350	STUD M6 x 18mm (Inside)
11	33.803	36.896	CLOSING BAR STUD (Inside)
12	33.803	4.907	CLOSING BAR STUD (Inside)
13	17.959	1.435	STUD M6 x 18mm (Inside)
-----			
14	3.750	38.053	LABEL_EXM (Inside)
15	33.803	20.902	HANDLE 885 ESL2A @ 0.0°

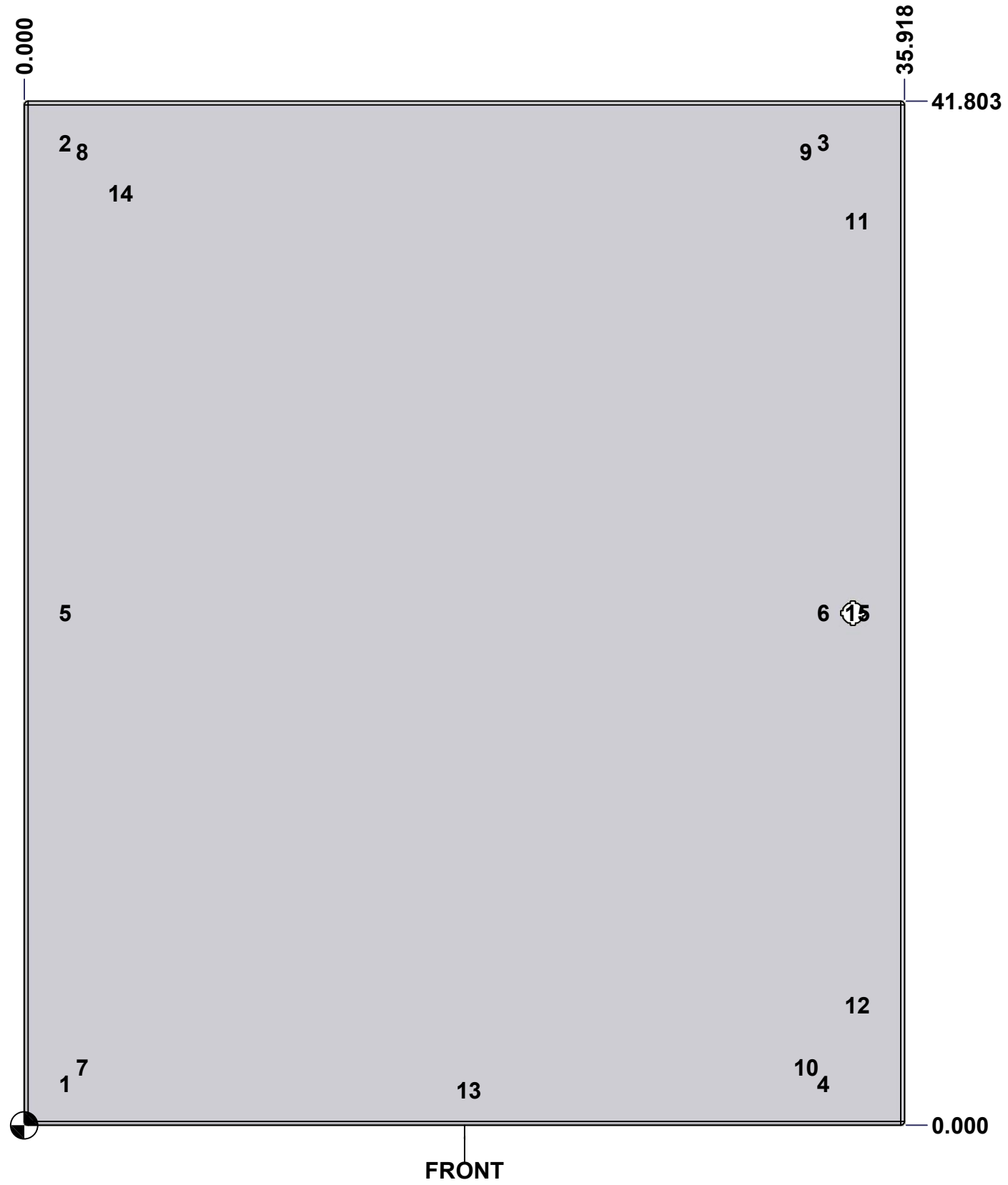

	Description	Status
	5412ES 42" x 36" Cover	(NULL)
	Part Number Numéro Pièce	Rev.
	<b>5412ES423616NOIPC</b>	<b>0</b> / 8 / 9



This drawing is confidential and must not be reproduced or used without the consent of EXM

Ce dessin est confidentiel et ne doit pas être reproduit ou utilisé sans le consentement de EXM

No.	Revisions	Date	By/Par

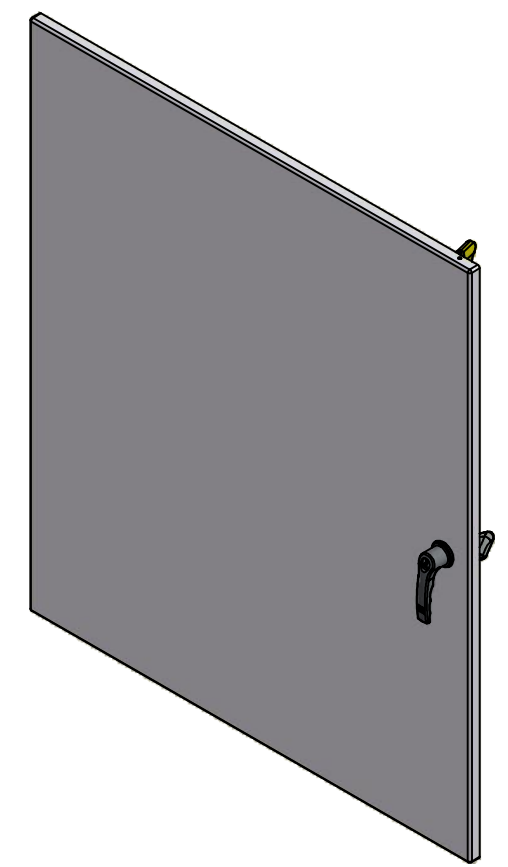

Isometric View

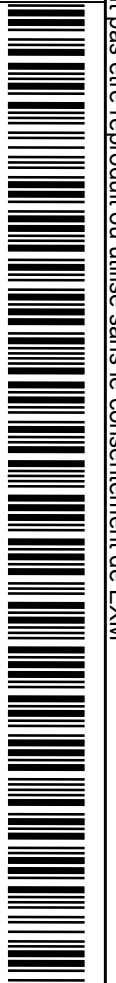

2	STK-Q-90042	4	5412 ES - Cabinet Closing Bar End (Small)
2	STK-Q-45655-42	0	5412 ES - Closing Bar
1	STK-Q-50536	13	5412 ES - Handle Cam Clockwise (Grip 32mm)
1	885 ESL2A	4	5412 ES Key Lock L-Handle (3 Pts)
1	STK-S-00100	0	3.5" x 2" Silver Milar Flexcon Sticker
1	STK-P-02400S	0	Powder Paint (Asa-61 Grey / Smooth)
1	STK-Q-46515	3	5412 ES Door Support with Brass Insert
2	STK-Q-46025-36-3	0.1. 1	5412 ES Horizontal Door Stiffener 36" (3 Pts)
2	STK-Q-46020-42	5	5412 ES Vertical Door Stiffener 42"
2	STK-Q-16405	6	Guide Stud - Small (No Paint Cap Required)
11	STK-Q-16055	1	M6 x 18mm Stud (No Paint Cap Required)
1	5412ES423616NOIPG	0	5412ES 42" x 36" Cover Gasket Part
1	5412ES423616NOIPC-P	0	5412ES 42" x 36" Cover Part
3	STK-K-09800	10	5412 ES Hinge with 2 Captive Hinge Pins
10	STK-Q-07220	1	M6 Nylon Insert Lock Nut

Qty	Part Name	Rev	Description
Parts List			

	Tél: (450) 979-4373 Fax: (450) 979-4626 <a href="http://www.exmweb.com">www.exmweb.com</a>	Flatness Aplatissement Max 3.0mm	
	Projection 	Customer Client	Date
Drawn By Dessiné Par	BoxCad: BoxCad	Date	12-Sep-19
Material Matière	14 Ga Cold Rolled A1008 CS Type B (1.7mm)		
Color Couleur	Asa-61 Grey	Finish Fini	Smooth
Description 5412ES 42" x 36" Cover		Detail Rev.	
Part Number Numéro Pièce <b>5412ES423616NOIPC</b>		Rev.	9 <b>0</b>