

This drawing is confidential and must not be reproduced or used without the consent of EXM

Ce dessin est confidentiel et ne doit pas être reproduit ou utilisé sans le consentement de EXM

| No. | Revisions | Date | By/Par |
|-----|-----------|------|--------|
| | | | |
| | | | |
| | | | |
| | | | |
| | | | |



TOP

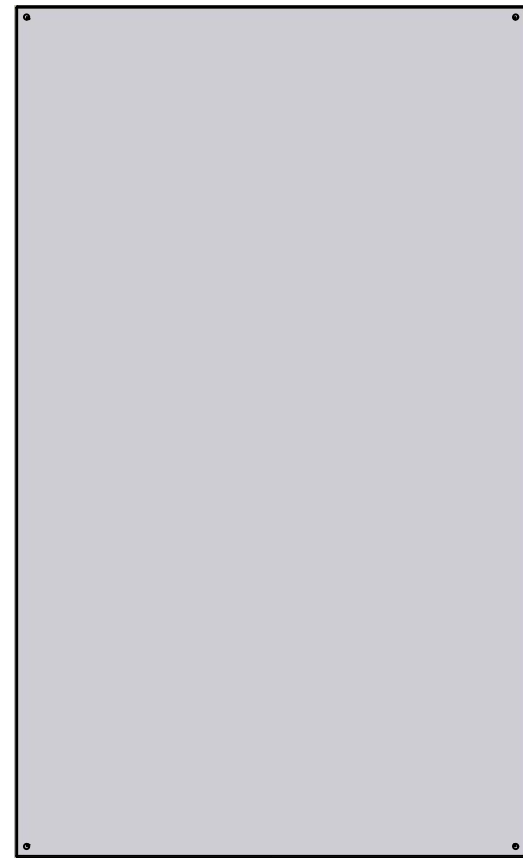

BACK

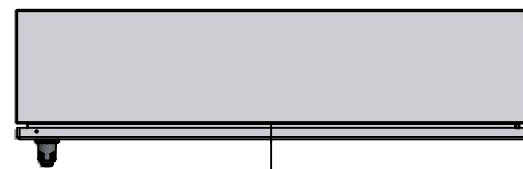

BOTTOM

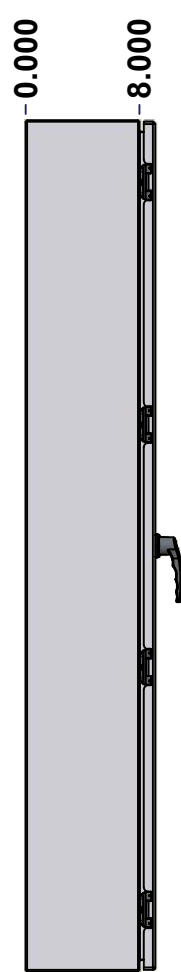

LEFT

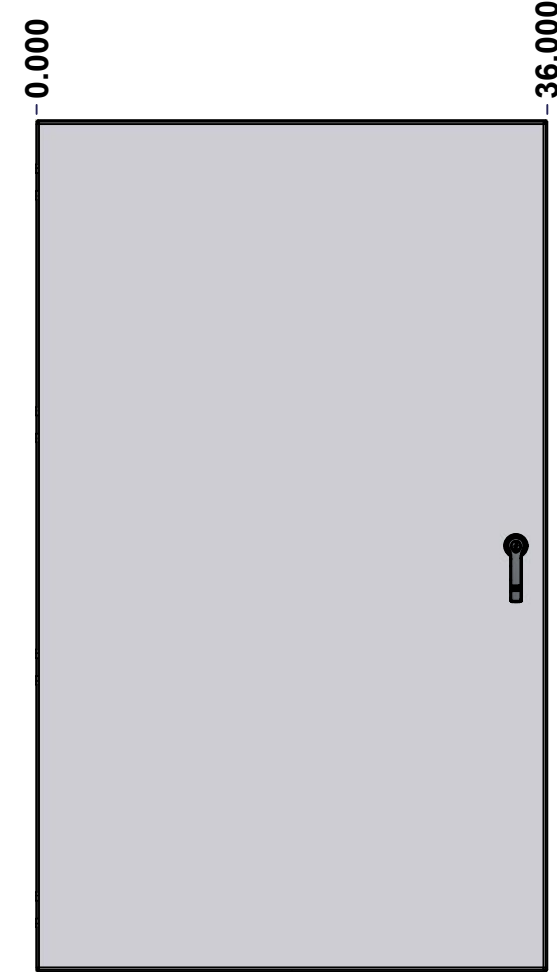

FRONT

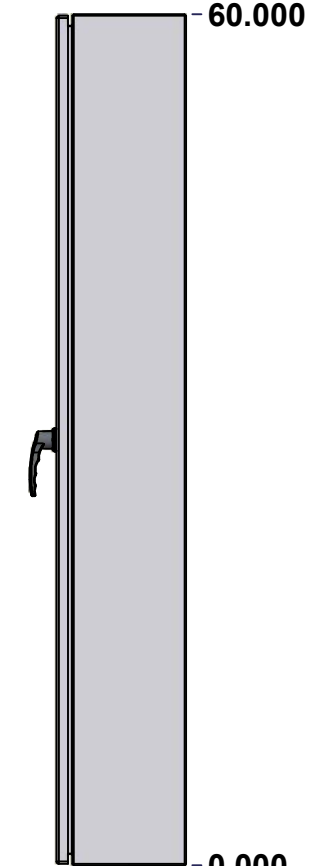

RIGHT

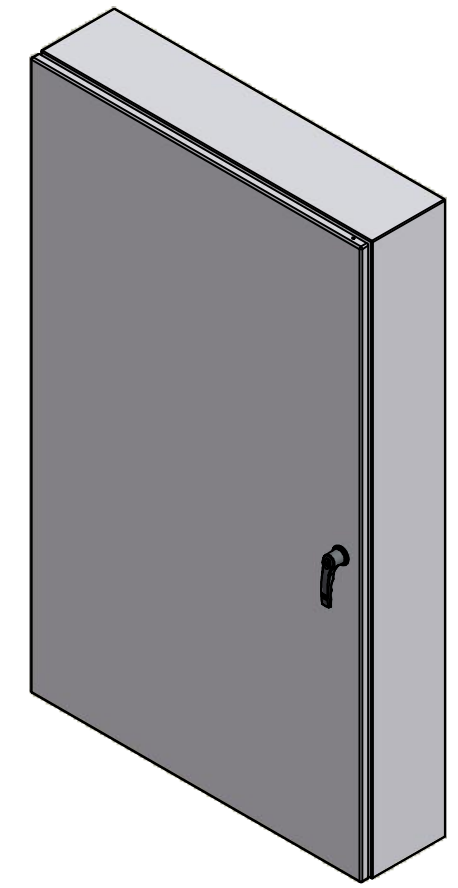

Isometric View

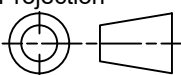

| | | |
|--|---|---|
|  Tél: (450) 979-4373 Fax: (450) 979-4626 www.exmweb.com | | Flatness Aplatissement Max 3.0mm Projection  |
| Customer Client | Date | |
| Drawn By Dessiné Par | BoxCad: BoxCad | Date 2019-09-13 |
| Material Matière | 14 Ga Cold Rolled A1008 CS Type B (1.7mm) | |
| Color Couleur | Asa-61 Grey | Finish Fini Smooth |
| Description | Detail Rev. | |
| 5412ES 60" x 36" x 8" Assembly | | |
| Part Number Numéro Pièce | Rev. | 1 |
| 5412ES603608NOIP | 0 | 9 |

SEE BILL OF MATERIAL ON LAST PAGE

This drawing is confidential and must not be reproduced or used without the consent of EXM

Ce dessin est confidentiel et ne doit pas être reproduit ou utilisé sans le consentement de EXM

| NOTE | |
|------|--|
| ITEM | DESCRIPTION |
| 1 | NEMA 4/12 Enclosure |
| 2 | C/W Standard ground studs on box and cover |
| 3 | C/W Standard door stiffener |
| 4 | W/O Inner panel |
| 5 | C/W Standard inner panel mounting studs |
| 6 | C/W 880 PP included (Not installed) |

| No. | Revisions | Date | By/Par |
|-----|-----------|------|--------|
| | | | |
| | | | |
| | | | |
| | | | |
| | | | |
| | | | |

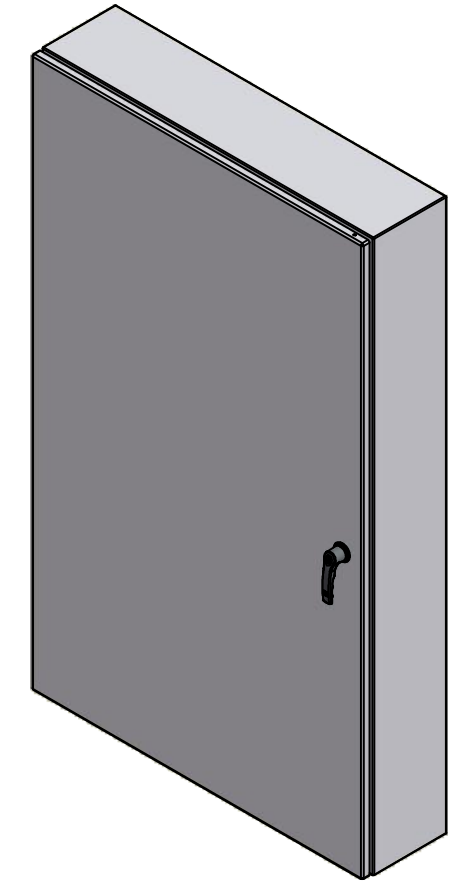

Isometric View

| PACKING | | |
|-----------------------|-----|--|
| ITEM | QTY | DESCRIPTION |
| Cardboard sleeve | 2 | Top and Bottom |
| Cardboard strip | 2 | Between back of enclosure and inner panel |
| Plastic bag | 1 | To protect cover surface and inside gasket |
| Cardboard corner | 4 | To reinforced for the plastic strap tightening |
| Plastic strap - Black | 2 | To Squeeze the 2 cardboard sleeve together |
| Packaging label | 3 | White label with PN |
| Plastic strap- Green | 2 | To secure the enclosure to the wood pallet |
| Wood Pallet | 1 | 2" deeper and 3" larger than enclosure size |

| | | | |
|------------|-------------------|-----|--|
| 1 | 880 PP | 6 | Self Adhesive Print Pocket |
| 1 | STK-K-01800 | 5 | 5412 ES Accessory Kit |
| 1 | 5412ES603608NOIPC | 0 | 5412ES 60" x 36" Cover |
| 1 | 5412ES603608NOIPB | 0 | 5412ES 60" x 36" x 8" Body |
| 4 | STK-Q-04050-08 | 0 | M6 x 8mm Hexagon Socket Head Machine Screw |
| Qty | Part Number | Rev | Description |
| Parts List | | | |

| | | |
|--|--|--|
| | Tél: (450) 979-4373 Fax: (450) 979-4626 www.exmweb.com | Flatness Aplatissement Max 3.0mm |
| | Projection | Customer Client Date |
| Drawn By Dessiné Par | BoxCad: BoxCad | Date 2019-09-13 |
| Material Matière | 14 Ga Cold Rolled A1008 CS Type B (1.7mm) | |
| Color Couleur | Asa-61 Grey | Finish Fini Smooth |
| Description 5412ES 60" x 36" x 8" Assembly | Detail Rev. | |
| Part Number Numéro Pièce 5412ES603608NOIP | Rev. 0 | 2 / 9 |

This drawing is confidential and must not be reproduced or used without the consent of EXM

Ce dessin est confidentiel et ne doit pas être reproduit ou utilisé sans le consentement de EXM

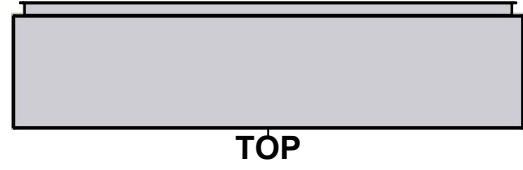

TOP

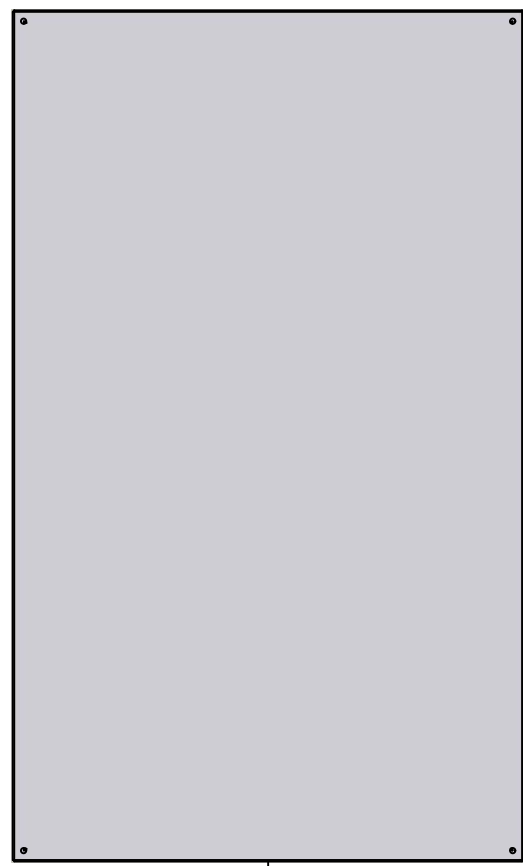

BACK



BOTTOM

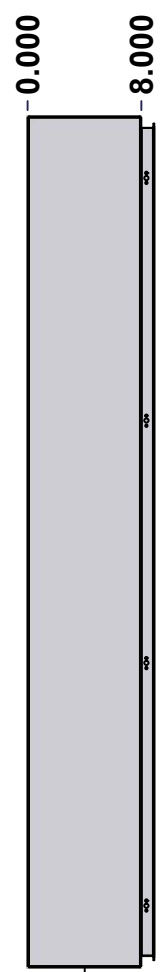

LEFT

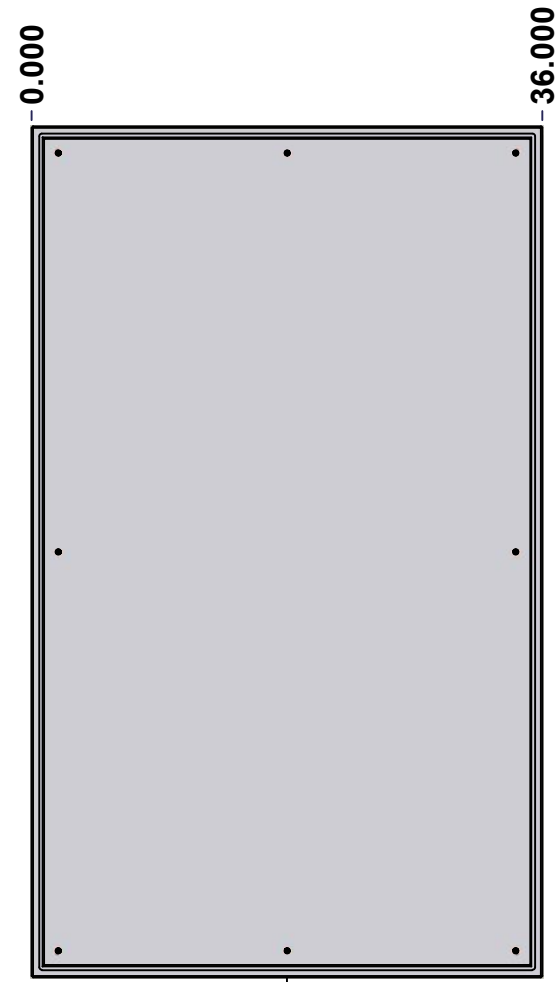

FRONT

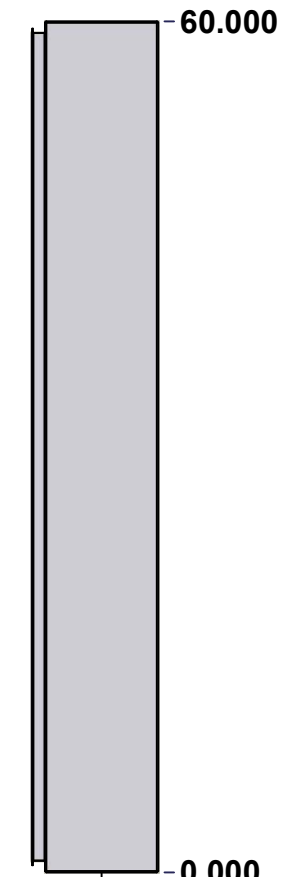

RIGHT

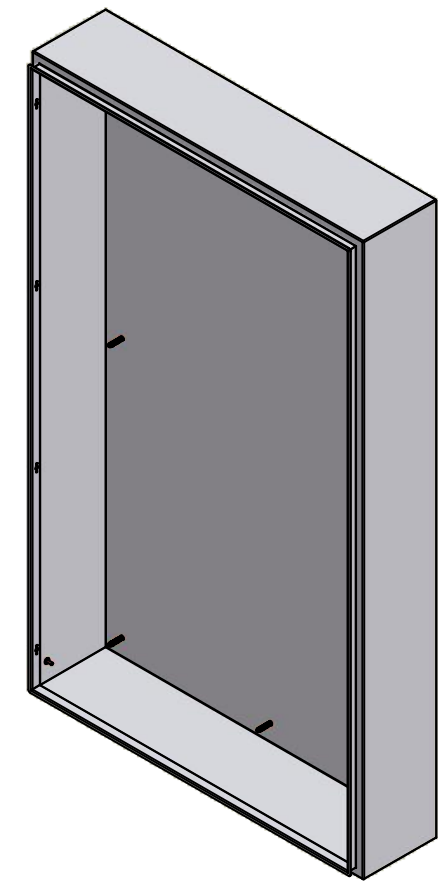

Isometric View

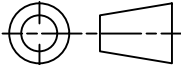

| No. | Revisions | Date | By/Par |
|-----|-----------|------|--------|
| | | | |
| | | | |
| | | | |
| | | | |
| | | | |

| | | |
|--|---|---|
|  Tél: (450) 979-4373 Fax: (450) 979-4626 www.exmweb.com | | Flatness Aplatissement Max 3.0mm Projection  |
| Customer Client | Date | |
| Drawn By Dessiné Par | BoxCad: BoxCad | Date 2019-09-13 |
| Material Matière | 14 Ga Cold Rolled A1008 CS Type B (1.7mm) | |
| Color Couleur | Asa-61 Grey | Finish Fini Smooth |
| Description | Detail Rev. | |
| 5412ES 60" x 36" x 8" Body | | |
| Part Number Numéro Pièce | Rev. 0 | 3 9 |

SEE BILL OF MATERIAL ON LAST PAGE

5412ES603608NOIPB

This drawing is confidential and must not be reproduced or used without the consent of EXM

Ce dessin est confidentiel et ne doit pas être reproduit ou utilisé sans le consentement de EXM

| STANDARD FEATURES ARE NOT LISTED IN THIS HOLE TABLE | | | |
|--|-------|-------|-----------------------------|
| HOLE TABLE - LEFT VIEW (CUSTOM FEATURE ONLY) | | | |
| CUT-OUT | XDIM | YDIM | DESCRIPTION |
| 1 | 6.500 | 2.000 | GND STUD M6 x 16mm (Inside) |

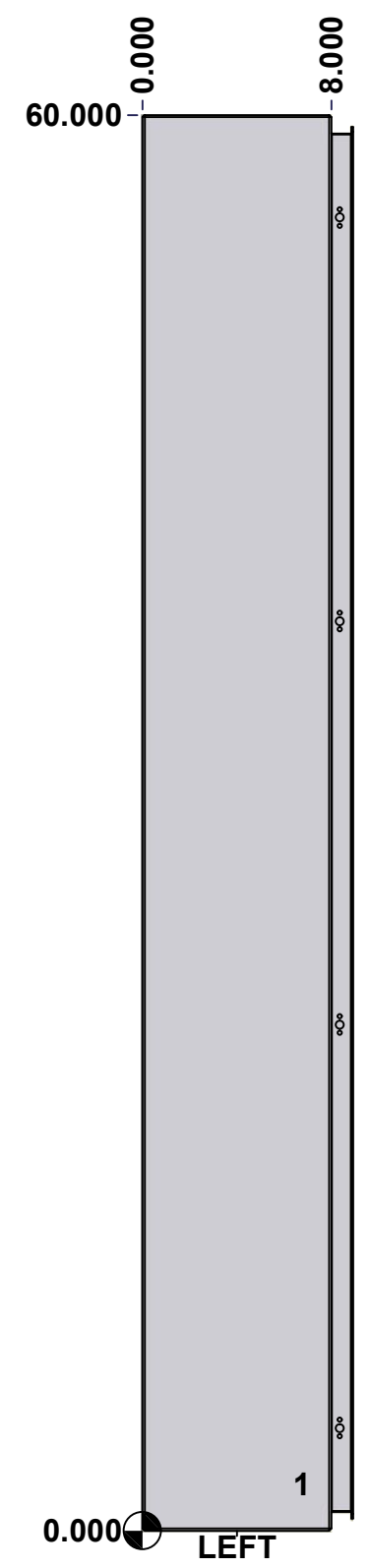

| | | | |
|--|-----------------------------|----------|--------|
| | Description | Status | |
| | 5412ES 60" x 36" x 8" Body | (NULL) | |
| | Part Number Numéro Pièce | Rev. | |
| | 5412ES603608NOIPB | 0 | 4 9 |

This drawing is confidential and must not be reproduced or used without the consent of EXM

Ce dessin est confidentiel et ne doit pas être reproduit ou utilisé sans le consentement de EXM

STANDARD FEATURES ARE NOT LISTED IN THIS HOLE TABLE

HOLE TABLE - BACK VIEW (CUSTOM FEATURE ONLY)

| CUT-OUT | XDIM | YDIM | DESCRIPTION |
|---------|--------|--------|----------------------------|
| 1 | 1.875 | 1.875 | IP STUD M8 x 35mm (Inside) |
| 2 | 1.875 | 58.125 | IP STUD M8 x 35mm (Inside) |
| 3 | 34.125 | 58.125 | IP STUD M8 x 35mm (Inside) |
| 4 | 34.125 | 1.875 | IP STUD M8 x 35mm (Inside) |
| 5 | 1.875 | 30.000 | IP STUD M8 x 35mm (Inside) |
| 6 | 34.125 | 30.000 | IP STUD M8 x 35mm (Inside) |
| 7 | 18.000 | 1.875 | IP STUD M8 x 35mm (Inside) |
| 8 | 18.000 | 58.125 | IP STUD M8 x 35mm (Inside) |
| ----- | | | |
| 9 | 35.250 | 59.250 | RND Ø0.390 |
| 10 | 0.750 | 59.250 | RND Ø0.390 |
| 11 | 0.750 | 0.750 | RND Ø0.390 |
| 12 | 35.250 | 0.750 | RND Ø0.390 |

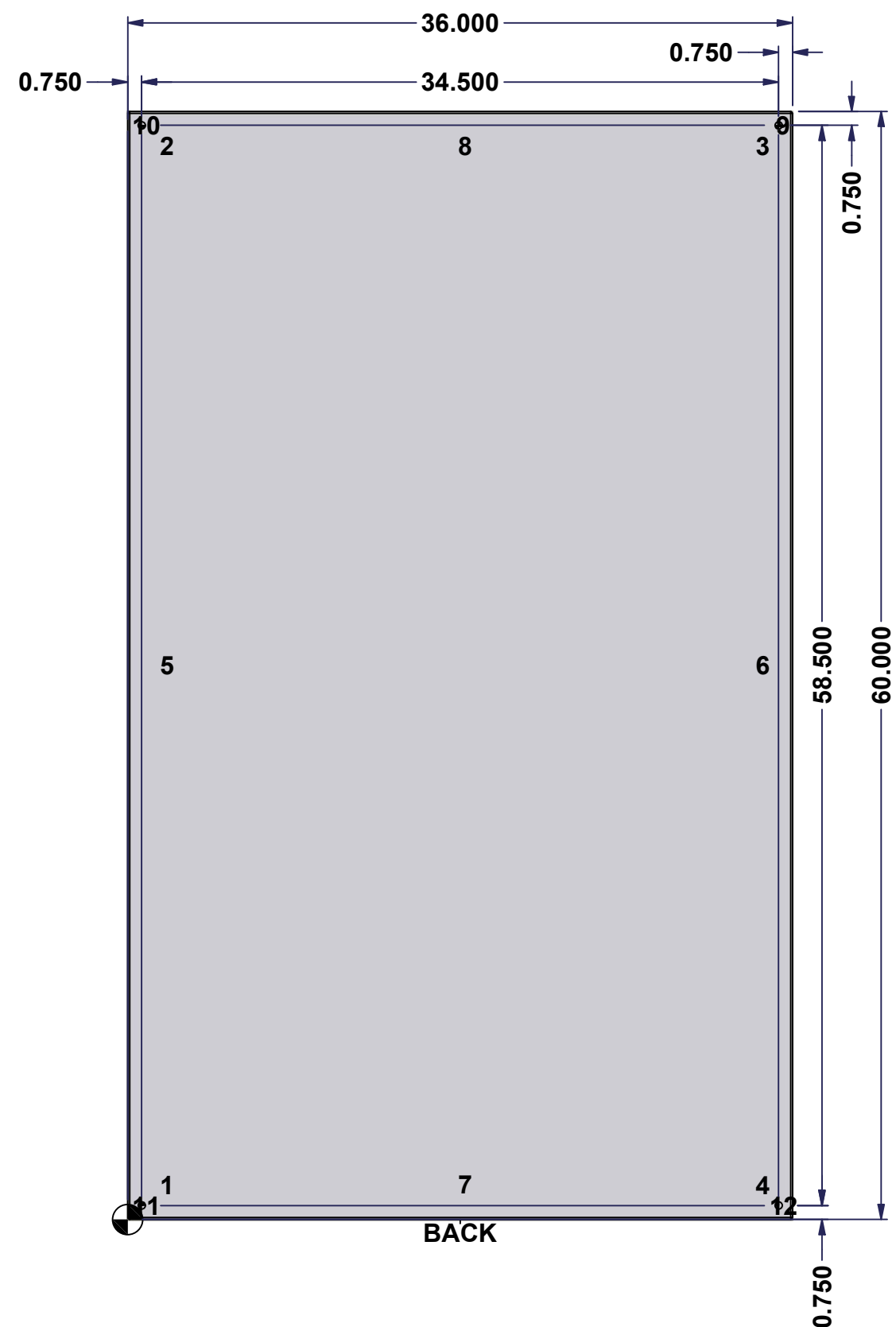

BACK

| | | |
|--|-----------------------------|--------|
| | Description | Status |
| | 5412ES 60" x 36" x 8" Body | (NULL) |
| | Part Number Numéro Pièce | Rev. |
| | 5412ES603608NOIPB | 0 |
| | | 5 |
| | | 9 |

This drawing is confidential and must not be reproduced or used without the consent of EXM

Ce dessin est confidentiel et ne doit pas être reproduit ou utilisé sans le consentement de EXM

| No. | Revisions | Date | By/Par |
|-----|-----------|------|--------|
| | | | |
| | | | |
| | | | |
| | | | |
| | | | |

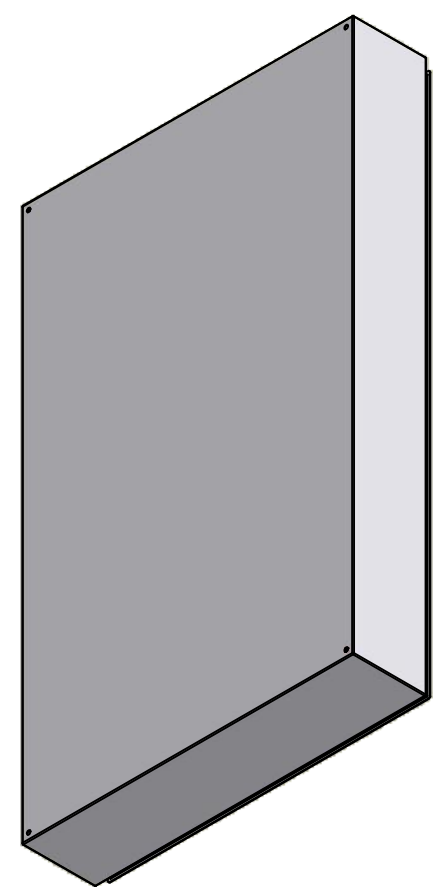

Isometric View

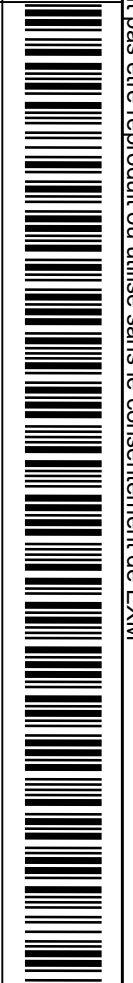

Tél: (450) 979-4373
 Fax: (450) 979-4626
www.exmweb.com

Flatness
Aplatissement
Max 3.0mm

Projection

| | |
|---|-----------------------|
| Customer Client | Date |
| Drawn By / Dessiné Par: BoxCad: BoxCad | Date: 2019-09-13 |
| Material / Matière: 14 Ga Cold Rolled A1008 CS Type B (1.7mm) | |
| Color / Couleur: Asa-61 Grey | Finish / Fini: Smooth |

| Qty | Part Number | Rev | Description |
|------------|---------------------|-----|--------------------------------------|
| 1 | STK-Q-16080 | 0 | Ground Stud M6 x 16mm |
| 1 | STK-P-02400S | 0 | Powder Paint (Asa-61 Grey / Smooth) |
| 8 | STK-Q-16005 | 1 | Stud M8 x 35 (No Paint Cap Required) |
| 1 | 5412ES603608NOIPB-P | 0 | 5412ES 60" x 36" x 8" Body Part |
| Parts List | | | |

| | |
|--|---------------|
| Description: 5412ES 60" x 36" x 8" Body | Detail Rev. |
| Part Number / Numéro Pièce: 5412ES603608NOIPB | Rev. 0 |
| | 6 / 9 |

This drawing is confidential and must not be reproduced or used without the consent of EXM

Ce dessin est confidentiel et ne doit pas être reproduit ou utilisé sans le consentement de EXM

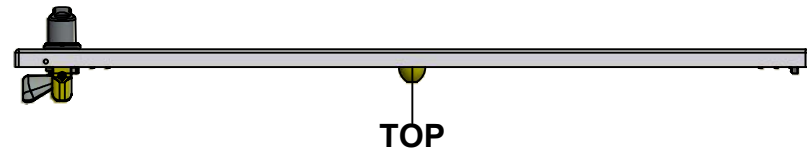

TOP

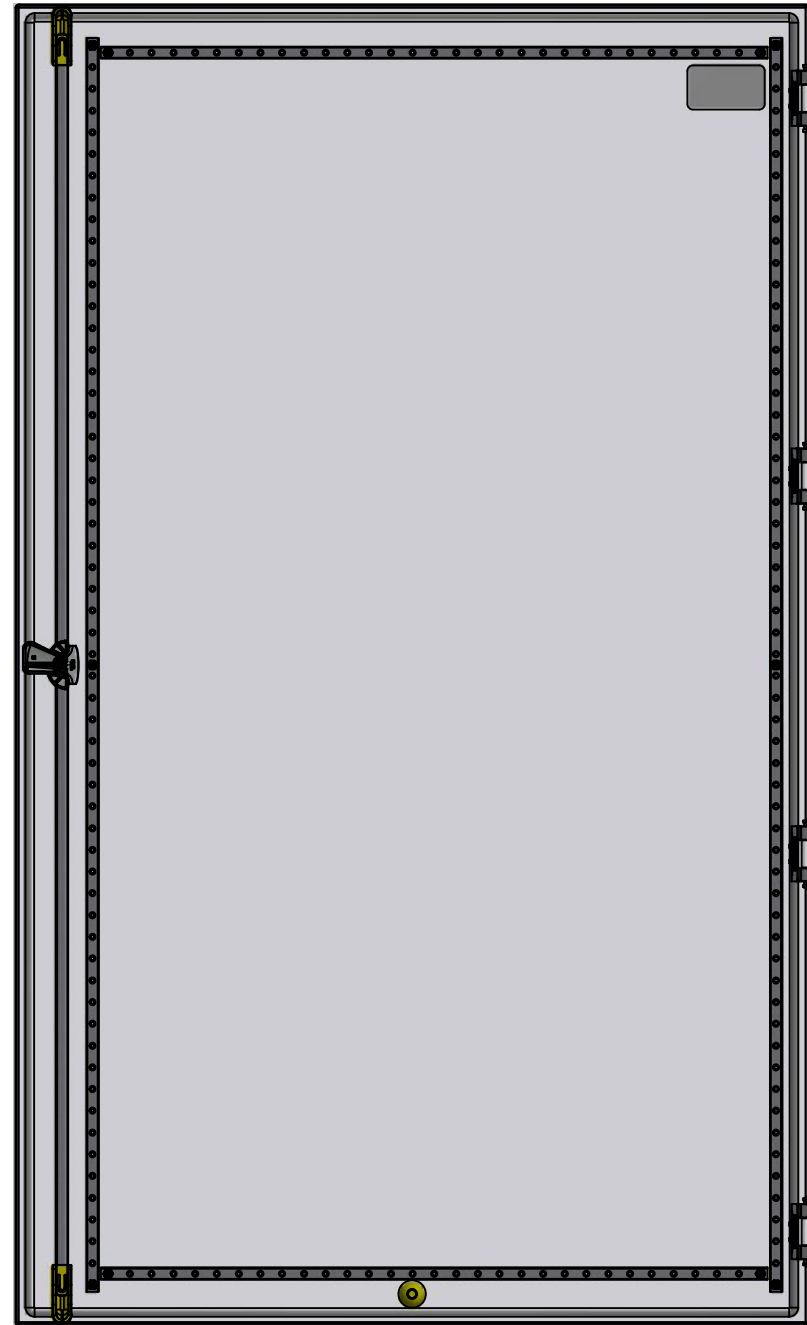

BACK

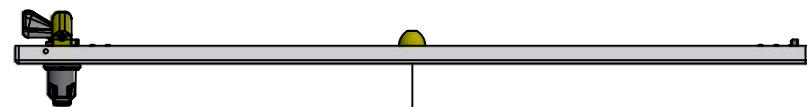

BOTTOM

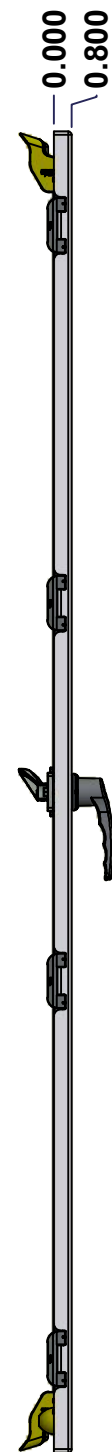

LEFT

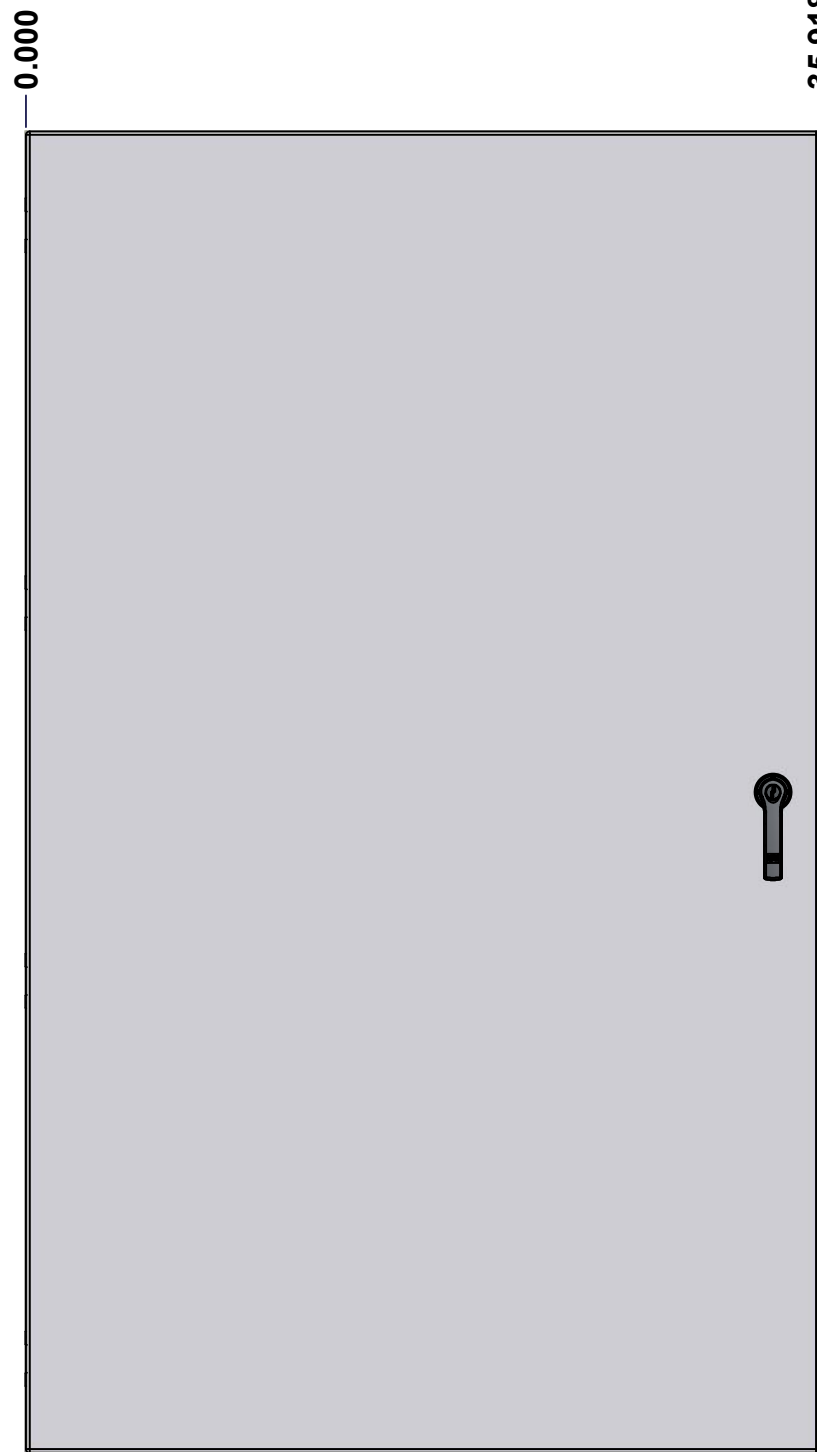

FRONT

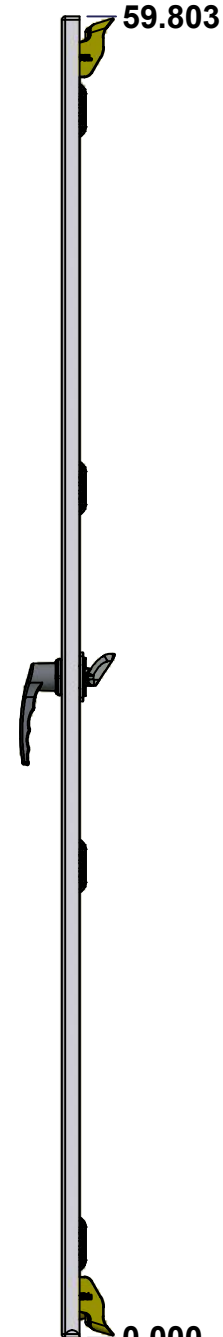

RIGHT

0.000
0.800

0.000

35.918

59.803

0.000

| No. | Revisions | Date | By/Par |
|-----|-----------|------|--------|
| | | | |
| | | | |
| | | | |
| | | | |
| | | | |

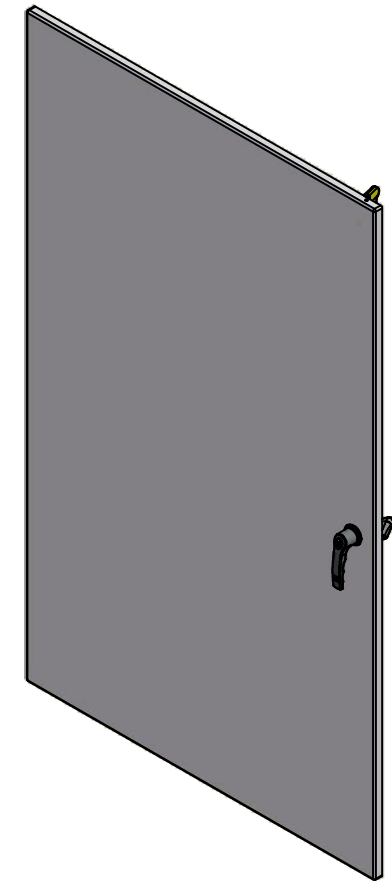

Isometric View



Tél: (450) 979-4373
Fax: (450) 979-4626
www.exmweb.com

Flatness
Aplatissement
Max 3.0mm
Projection

| | |
|---|-----------------------|
| Customer Client | Date |
| Drawn By Dessiné Par BoxCad: BoxCad | Date 2019-09-13 |
| Material Matière 14 Ga Cold Rolled A1008 CS Type B (1.7mm) | |
| Color Couleur Asa-61 Grey | Finish Fini Smooth |
| Description 5412ES 60" x 36" Cover | Detail Rev. |
| Part Number Numéro Pièce 5412ES603608NOIPC | Rev. 7 0 |

SEE BILL OF MATERIAL ON LAST PAGE

This drawing is confidential and must not be reproduced or used without the consent of EXM

Ce dessin est confidentiel et ne doit pas être reproduit ou utilisé sans le consentement de EXM

STANDARD FEATURES ARE NOT LISTED IN THIS HOLE TABLE

HOLE TABLE - FRONT VIEW (CUSTOM FEATURE ONLY)

| CUT-OUT | XDIM | YDIM | DESCRIPTION |
|---------|--------|--------|---------------------------|
| 1 | 1.486 | 1.850 | STUD M6 x 18mm (Inside) |
| 2 | 1.486 | 57.953 | STUD M6 x 18mm (Inside) |
| 3 | 32.423 | 57.953 | STUD M6 x 18mm (Inside) |
| 4 | 32.423 | 1.850 | STUD M6 x 18mm (Inside) |
| 5 | 1.486 | 29.902 | STUD M6 x 18mm (Inside) |
| 6 | 32.423 | 29.902 | STUD M6 x 18mm (Inside) |
| 7 | 2.191 | 2.350 | STUD M6 x 18mm (Inside) |
| 8 | 2.191 | 57.619 | STUD M6 x 18mm (Inside) |
| 9 | 31.718 | 57.619 | STUD M6 x 18mm (Inside) |
| 10 | 31.718 | 2.350 | STUD M6 x 18mm (Inside) |
| 11 | 33.803 | 54.896 | CLOSING BAR STUD (Inside) |
| 12 | 33.803 | 4.907 | CLOSING BAR STUD (Inside) |
| 13 | 17.959 | 1.435 | STUD M6 x 18mm (Inside) |
| ----- | | | |
| 14 | 3.750 | 56.053 | LABEL_EXM (Inside) |
| 15 | 33.803 | 29.902 | HANDLE 885 ESL2A @ 0.0° |

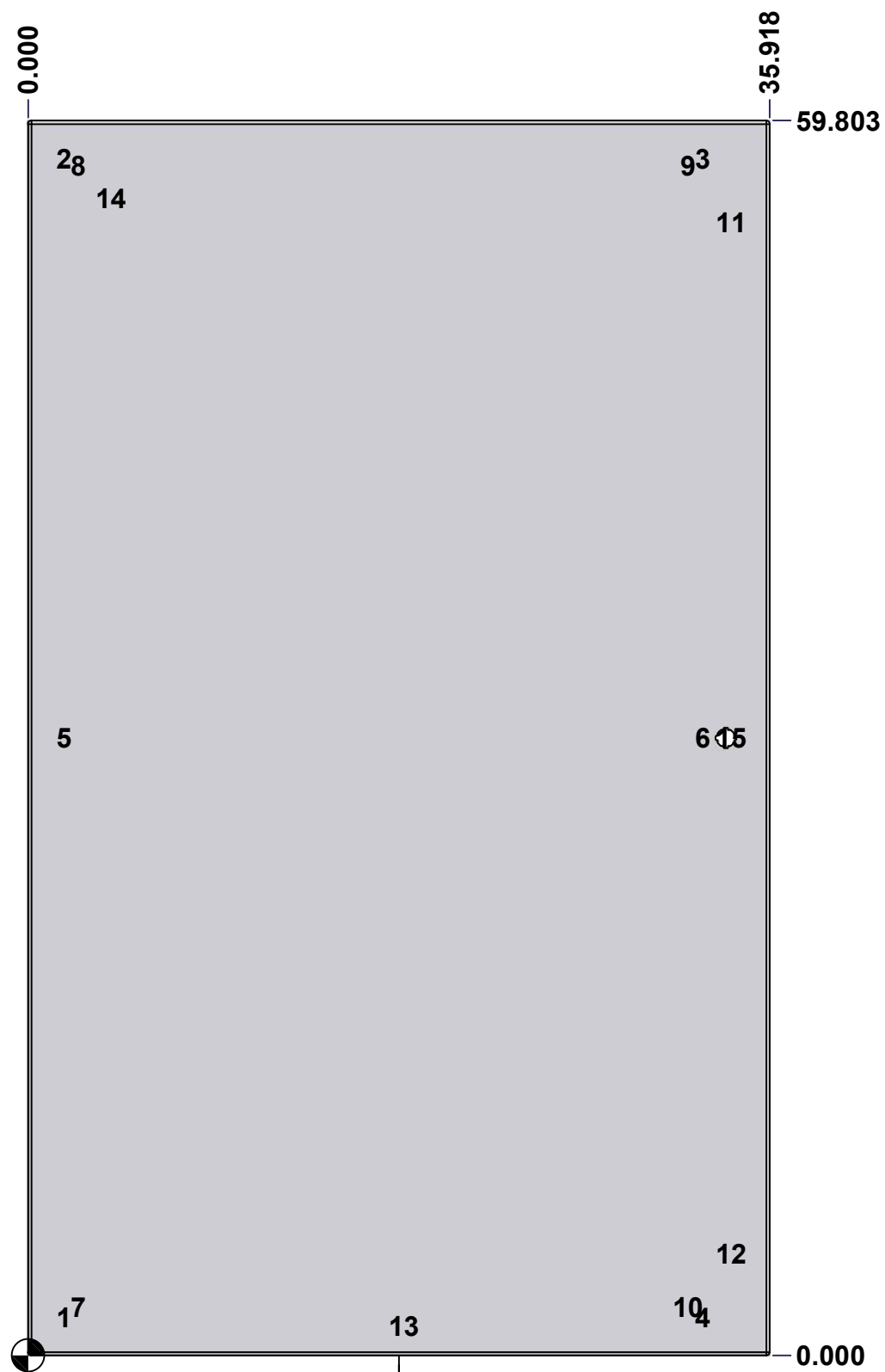

FRONT

| | | |
|--|-----------------------------|------------------|
| | Description | Status |
| | 5412ES 60" x 36" Cover | (NULL) |
| | Part Number Numéro Pièce | Rev. |
| | 5412ES603608NOIPC | 0 / 8 / 9 |

This drawing is confidential and must not be reproduced or used without the consent of EXM

Ce dessin est confidentiel et ne doit pas être reproduit ou utilisé sans le consentement de EXM

| No. | Revisions | Date | By/Par |
|-----|-----------|------|--------|
| | | | |
| | | | |
| | | | |
| | | | |
| | | | |

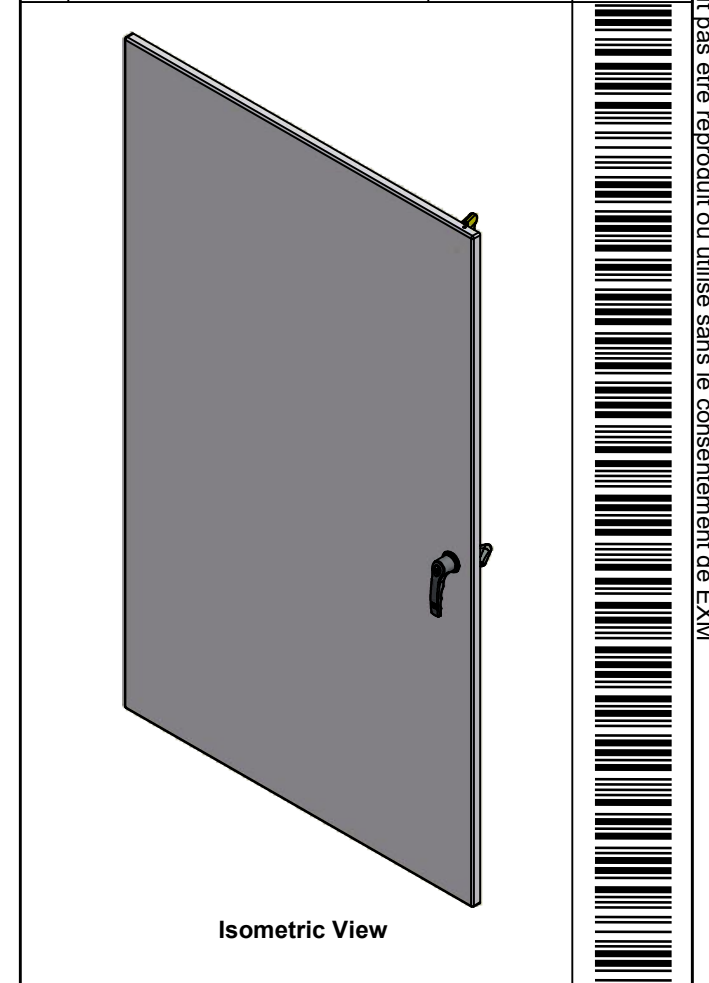

| 2 | STK-Q-90042 | 4 | 5412 ES - Cabinet Closing Bar End (Small) |
|------------|---------------------|-----------|---|
| 2 | STK-Q-45655-60 | 0 | 5412 ES - Closing Bar |
| 1 | STK-Q-50536 | 13 | 5412 ES - Handle Cam Clockwise (Grip 32mm) |
| 1 | 885 ESL2A | 4 | 5412 ES Key Lock L-Handle (3 Pts) |
| 1 | STK-S-00100 | 0 | 3.5" x 2" Silver Milar Flexcon Sticker |
| 1 | STK-P-02400S | 0 | Powder Paint (Asa-61 Grey / Smooth) |
| 1 | STK-Q-46515 | 3 | 5412 ES Door Support with Brass Insert |
| 2 | STK-Q-46025-36-3 | 0.1. 1 | 5412 ES Horizontal Door Stiffener 36" (3 Pts) |
| 2 | STK-Q-46020-60 | 5 | 5412 ES Vertical Door Stiffener 60" |
| 2 | STK-Q-16405 | 6 | Guide Stud - Small (No Paint Cap Required) |
| 11 | STK-Q-16055 | 1 | M6 x 18mm Stud (No Paint Cap Required) |
| 1 | 5412ES603608NOIPG | 0 | 5412ES 60" x 36" Cover Gasket Part |
| 1 | 5412ES603608NOIPC-P | 0 | 5412ES 60" x 36" Cover Part |
| 4 | STK-K-09800 | 10 | 5412 ES Hinge with 2 Captive Hinge Pins |
| 10 | STK-Q-07220 | 1 | M6 Nylon Insert Lock Nut |
| Qty | Part Name | Rev | Description |
| Parts List | | | |

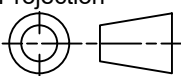
| | |
|--|---|
|  Tél: (450) 979-4373 Fax: (450) 979-4626 www.exmweb.com | Flatness Aplatissement |
| | Max 3.0mm |
| Projection |  |
| Customer Client | Date |
| Drawn By Dessiné Par BoxCad: BoxCad | Date 2019-09-13 |
| Material Matière 14 Ga Cold Rolled A1008 CS Type B (1.7mm) | |
| Color Couleur Asa-61 Grey | Finish Fini Smooth |
| Description 5412ES 60" x 36" Cover | Detail Rev. |
| Part Number Numéro Pièce 5412ES603608NOIPC | Rev. 0 |
| | 9 |