

This drawing is confidential and must not be reproduced or used without the consent of EXM

Ce dessin est confidentiel et ne doit pas être reproduit ou utilisé sans le consentement de EXM

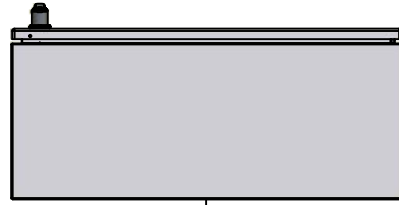

TOP

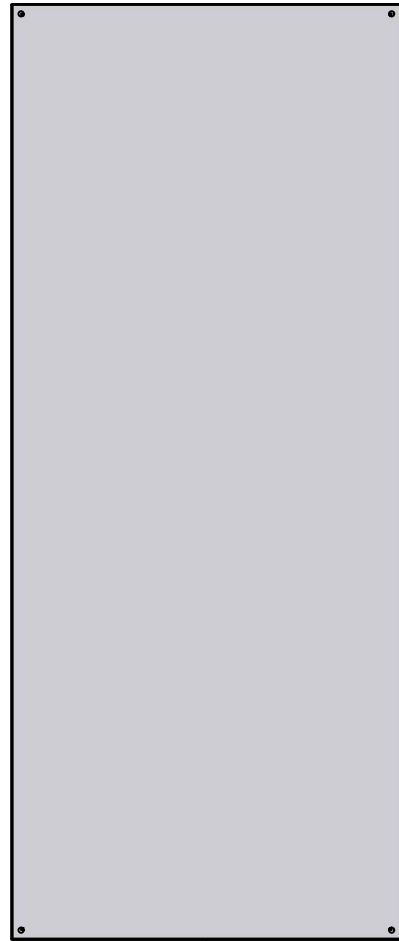

BACK

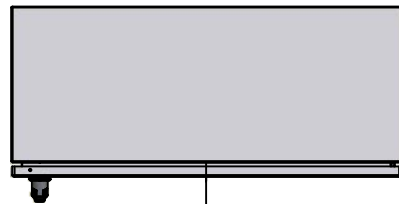

BOTTOM

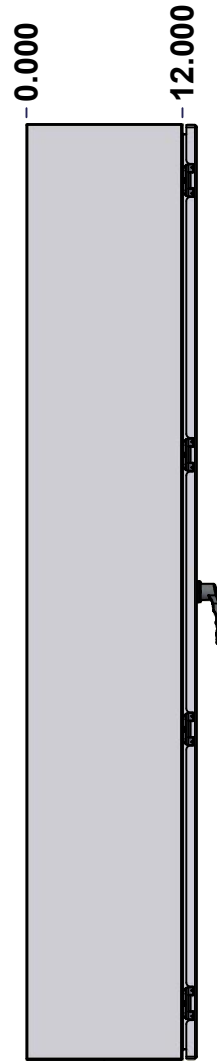

LEFT

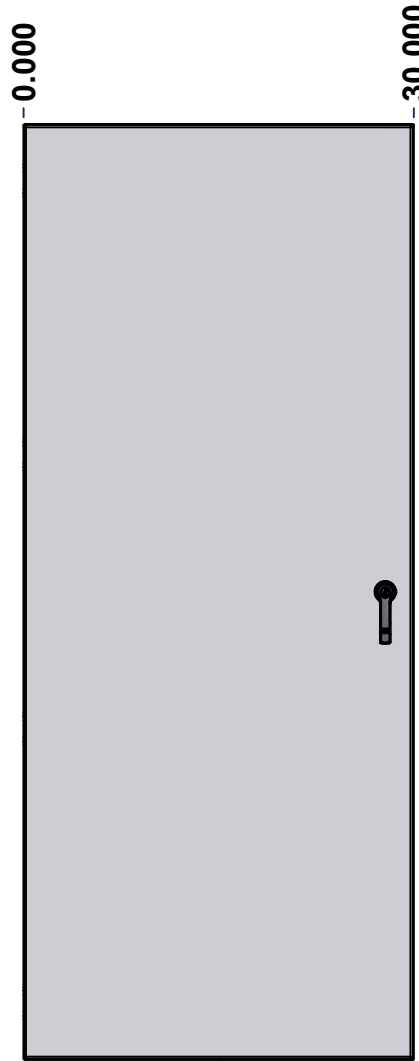

FRONT

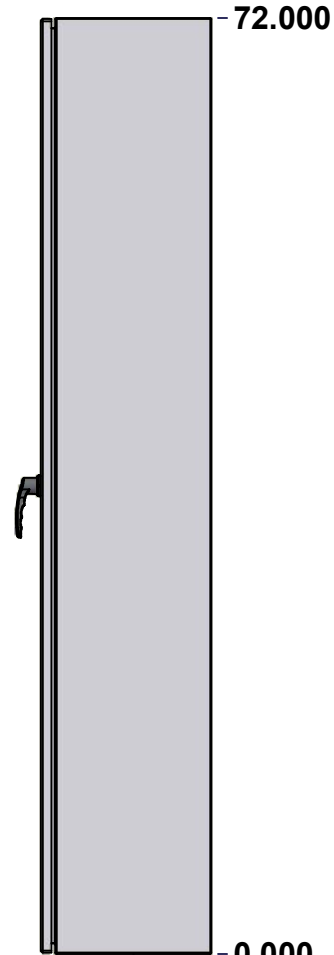

RIGHT

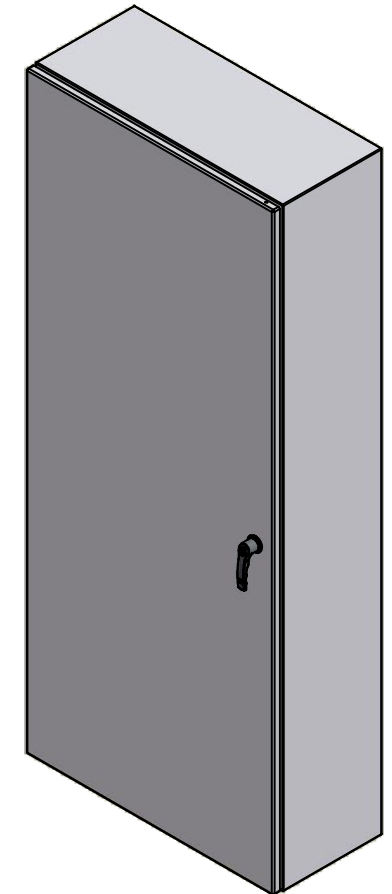

Isometric View

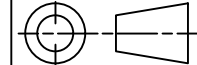

No.	Revisions	Date	By/Par

 Tél: (450) 979-4373 Fax: (450) 979-4626 www.exmweb.com		Flatness Aplatissement Max 3.0mm Projection 
Customer Client	Date	
Drawn By Dessiné Par	BoxCad: BoxCad	Date 2019-09-13
Material Matière	14 Ga Cold Rolled A1008 CS Type B (1.7mm)	
Color Couleur	Asa-61 Grey	Finish Fini Smooth
Description	Detail Rev.	
5412ES 72" x 30" x 12" Assembly		
Part Number Numéro Pièce	Rev.	1
5412ES723012NOIP	0	9

SEE BILL OF MATERIAL ON LAST PAGE

This drawing is confidential and must not be reproduced or used without the consent of EXM

Ce dessin est confidentiel et ne doit pas être reproduit ou utilisé sans le consentement de EXM

NOTE	
ITEM	DESCRIPTION
1	NEMA 4/12 Enclosure
2	C/W Standard ground studs on box and cover
3	C/W Standard door stiffener
4	W/O Inner panel
5	C/W Standard inner panel mounting studs
6	C/W 880 PP included (Not installed)

No.	Revisions	Date	By/Par

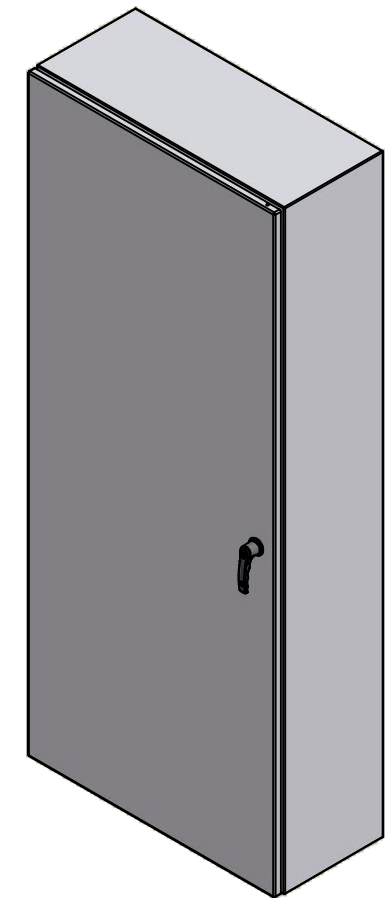

Isometric View



PACKING		
ITEM	QTY	DESCRIPTION
Cardboard sleeve	2	Top and Bottom
Cardboard strip	2	Between back of enclosure and inner panel
Plastic bag	1	To protect cover surface and inside gasket
Cardboard corner	4	To reinforced for the plastic strap tightening
Plastic strap - Black	2	To Squeeze the 2 cardboard sleeve together
Packaging label	3	White label with PN
Plastic strap- Green	2	To secure the enclosure to the wood pallet
Wood Pallet	1	2" deeper and 3" larger than enclosure size

1	880 PP	6	Self Adhesive Print Pocket
1	STK-K-01800	5	5412 ES Accessory Kit
1	5412ES723012NOIPC	0	5412ES 72" x 30" Cover
1	5412ES723012NOIPB	0	5412ES 72" x 30" x 12" Body
4	STK-Q-04050-08	0	M6 x 8mm Hexagon Socket Head Machine Screw
Qty	Part Number	Rev	Description
Parts List			

<p>Tél: (450) 979-4373 Fax: (450) 979-4626 www.exmweb.com</p>	Flatness Aplatissement	Max 3.0mm
	Projection	
Customer Client	Date	
Drawn By Dessiné Par	BoxCad: BoxCad	Date 2019-09-13
Material Matière	14 Ga Cold Rolled A1008 CS Type B (1.7mm)	
Color Couleur	Asa-61 Grey	Finish Fini Smooth
Description	5412ES 72" x 30" x 12" Assembly	
Part Number Numéro Pièce	5412ES723012NOIP	Rev. 0
		2 9

This drawing is confidential and must not be reproduced or used without the consent of EXM

Ce dessin est confidentiel et ne doit pas être reproduit ou utilisé sans le consentement de EXM



TOP



BACK



BOTTOM

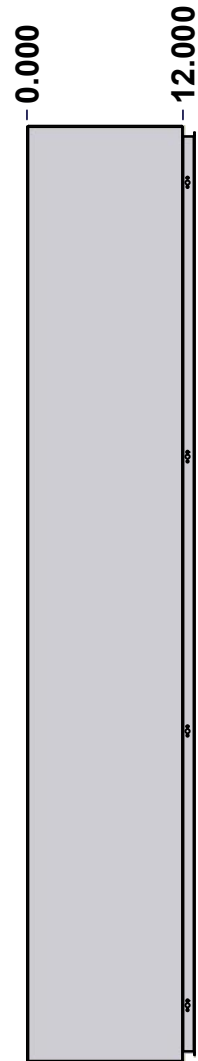

LEFT

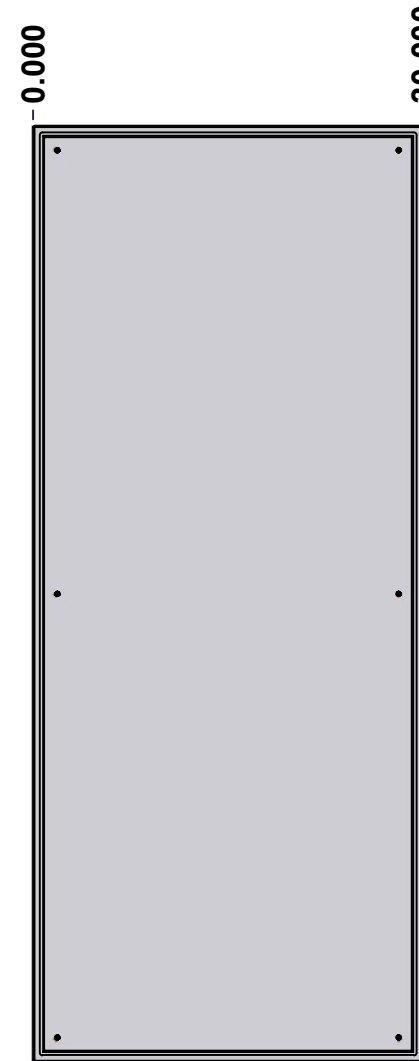

FRONT

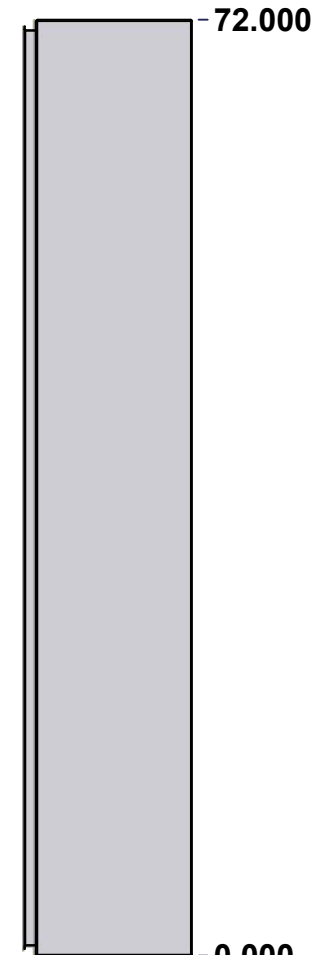

RIGHT

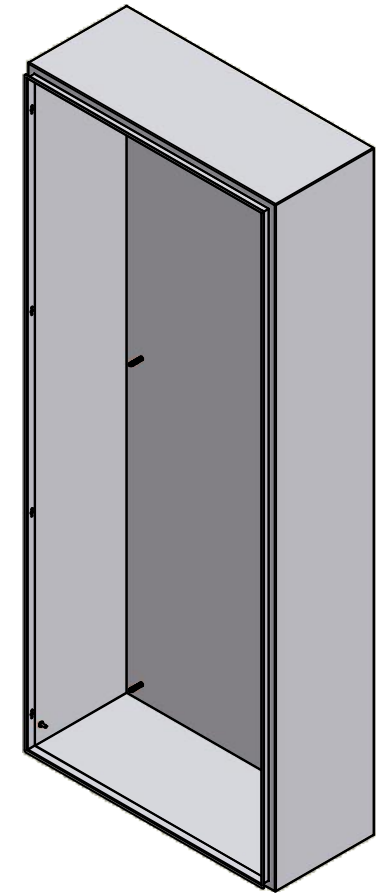

Isometric View

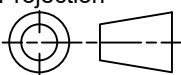

No.	Revisions	Date	By/Par

 Tél: (450) 979-4373 Fax: (450) 979-4626 www.exmweb.com		Flatness Aplatissement Max 3.0mm Projection 
Customer Client	Date	
Drawn By Dessiné Par	BoxCad: BoxCad	Date 2019-09-13
Material Matière	14 Ga Cold Rolled A1008 CS Type B (1.7mm)	
Color Couleur	Asa-61 Grey	Finish Fini Smooth
Description	Detail Rev.	
5412ES 72" x 30" x 12" Body		
Part Number Numéro Pièce	Rev.	3
5412ES723012NOIPB	0	9

SEE BILL OF MATERIAL ON LAST PAGE

This drawing is confidential and must not be reproduced or used without the consent of EXM

Ce dessin est confidentiel et ne doit pas être reproduit ou utilisé sans le consentement de EXM

STANDARD FEATURES ARE NOT LISTED IN THIS HOLE TABLE

HOLE TABLE - LEFT VIEW (CUSTOM FEATURE ONLY)

CUT-OUT	XDIM	YDIM	DESCRIPTION
1	10.500	2.000	GND STUD M6 x 16mm (Inside)

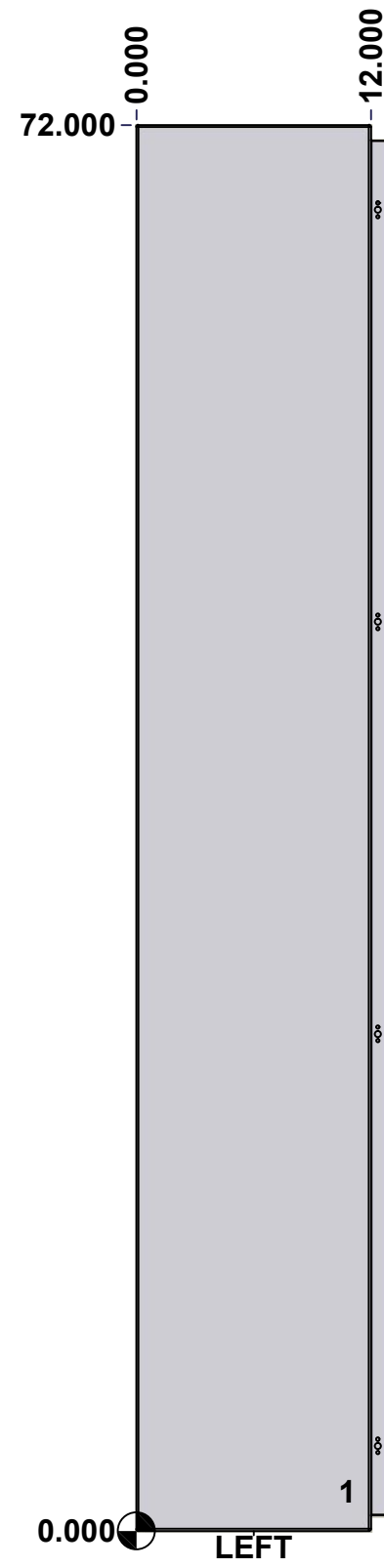

	Description	Status	
	5412ES 72" x 30" x 12" Body	(NULL)	
	Part Number Numéro Pièce	Rev.	
	5412ES723012NOIPB	0	4/9

This drawing is confidential and must not be reproduced or used without the consent of EXM

Ce dessin est confidentiel et ne doit pas être reproduit ou utilisé sans le consentement de EXM

STANDARD FEATURES ARE NOT LISTED IN THIS HOLE TABLE

HOLE TABLE - BACK VIEW (CUSTOM FEATURE ONLY)

CUT-OUT	XDIM	YDIM	DESCRIPTION
1	1.875	1.875	IP STUD M8 x 35mm (Inside)
2	1.875	70.125	IP STUD M8 x 35mm (Inside)
3	28.125	70.125	IP STUD M8 x 35mm (Inside)
4	28.125	1.875	IP STUD M8 x 35mm (Inside)
5	1.875	36.000	IP STUD M8 x 35mm (Inside)
6	28.125	36.000	IP STUD M8 x 35mm (Inside)

7	29.250	0.750	RND Ø0.390
8	29.250	71.250	RND Ø0.390
9	0.750	71.250	RND Ø0.390
10	0.750	0.750	RND Ø0.390

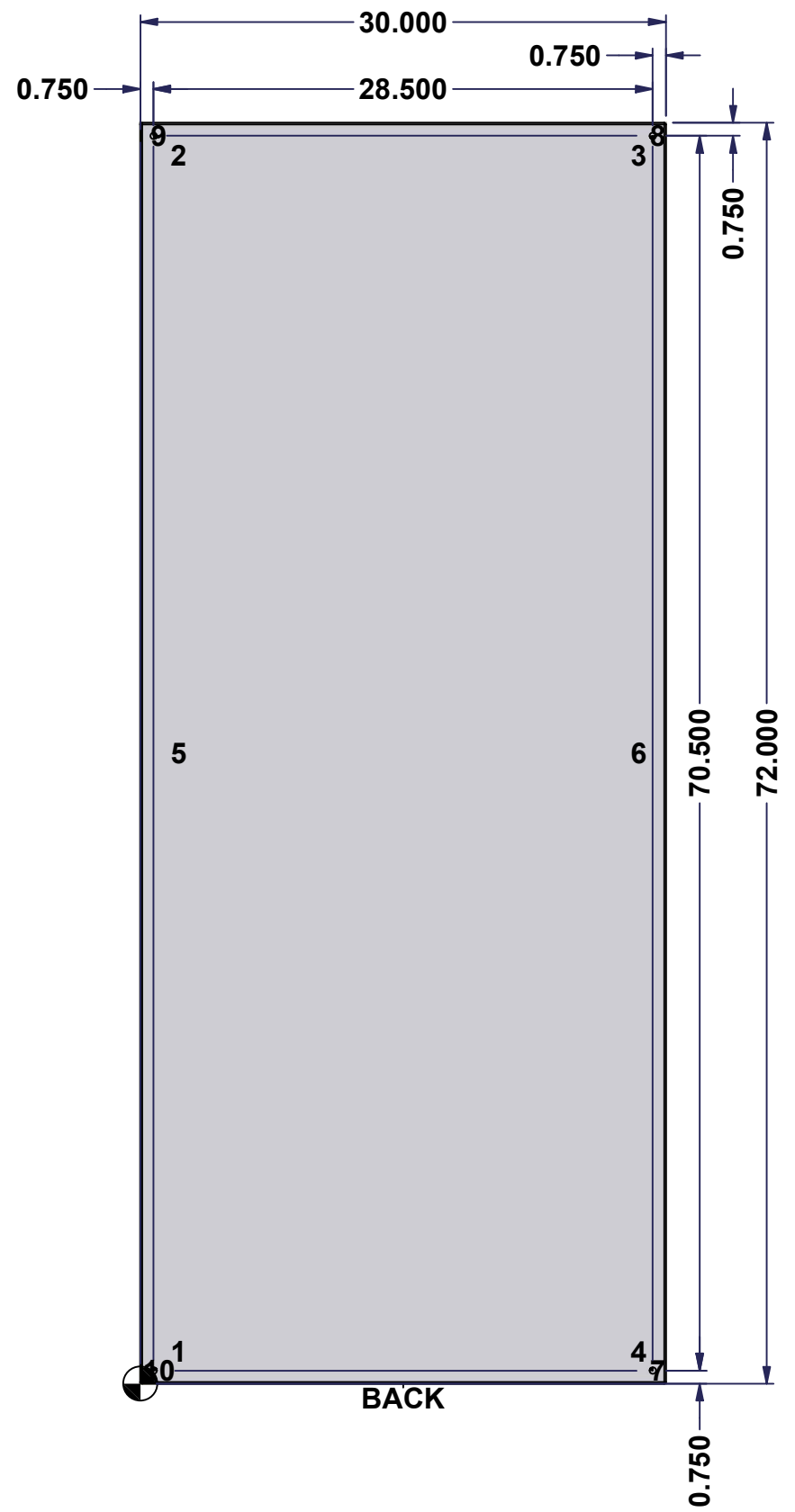

BACK

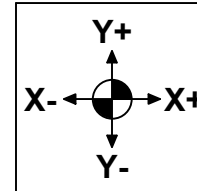

Description		Status	
5412ES 72" x 30" x 12" Body		(NULL)	
Part Number Numéro Pièce		Rev.	5
5412ES723012NOIPB		0	9

This drawing is confidential and must not be reproduced or used without the consent of EXM

Ce dessin est confidentiel et ne doit pas être reproduit ou utilisé sans le consentement de EXM

No.	Revisions	Date	By/Par

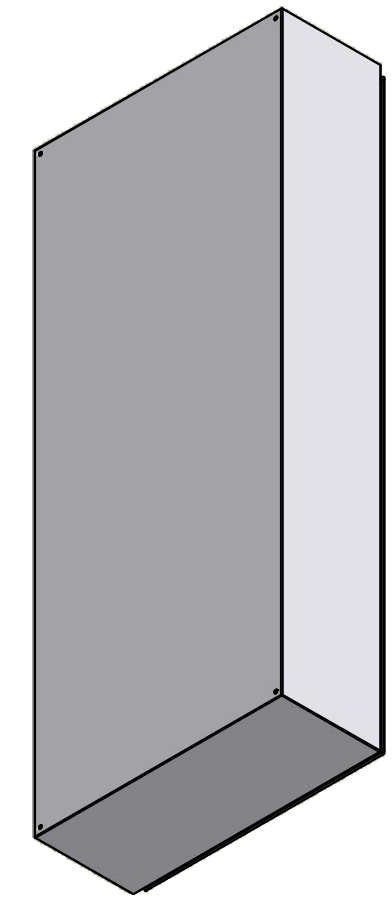

Isometric View

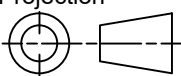

 Tél: (450) 979-4373 Fax: (450) 979-4626 www.exmweb.com	Flatness Aplatissement Max 3.0mm
	Projection 
Customer Client	Date
Drawn By Dessiné Par BoxCad: BoxCad	Date 2019-09-13
Material Matière 14 Ga Cold Rolled A1008 CS Type B (1.7mm)	
Color Couleur Asa-61 Grey	Finish Fini Smooth
Description 5412ES 72" x 30" x 12" Body	
Part Number Numéro Pièce 5412ES723012NOIPB	Rev. 6 0

Qty	Part Number	Rev	Description
1	STK-Q-16080	0	Ground Stud M6 x 16mm
1	STK-P-02400S	0	Powder Paint (Asa-61 Grey / Smooth)
6	STK-Q-16005	1	Stud M8 x 35 (No Paint Cap Required)
1	5412ES723012NOIPB-P	0	5412ES 72" x 30" x 12" Body Part
Parts List			

This drawing is confidential and must not be reproduced or used without the consent of EXM

Ce dessin est confidentiel et ne doit pas être reproduit ou utilisé sans le consentement de EXM

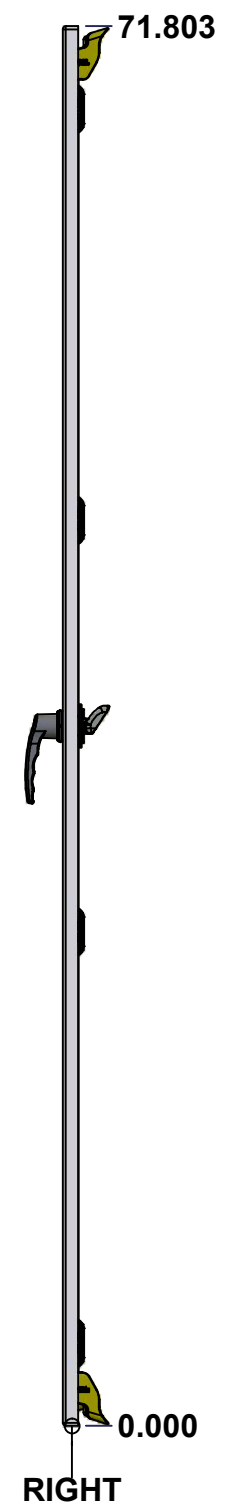
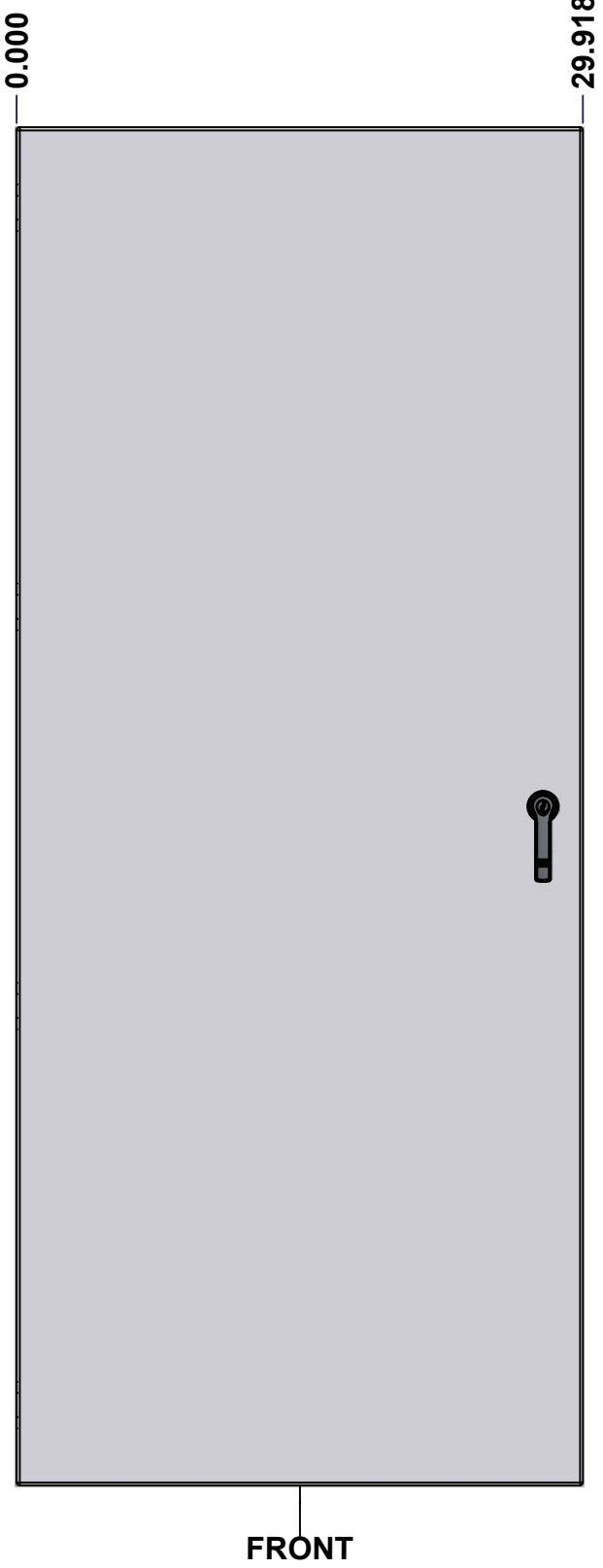
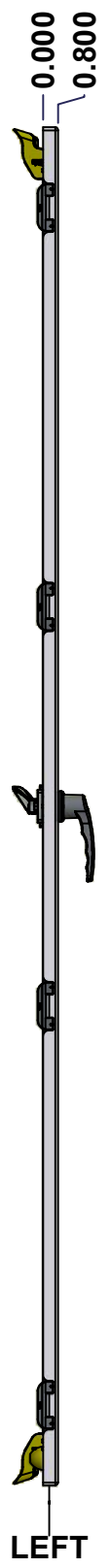
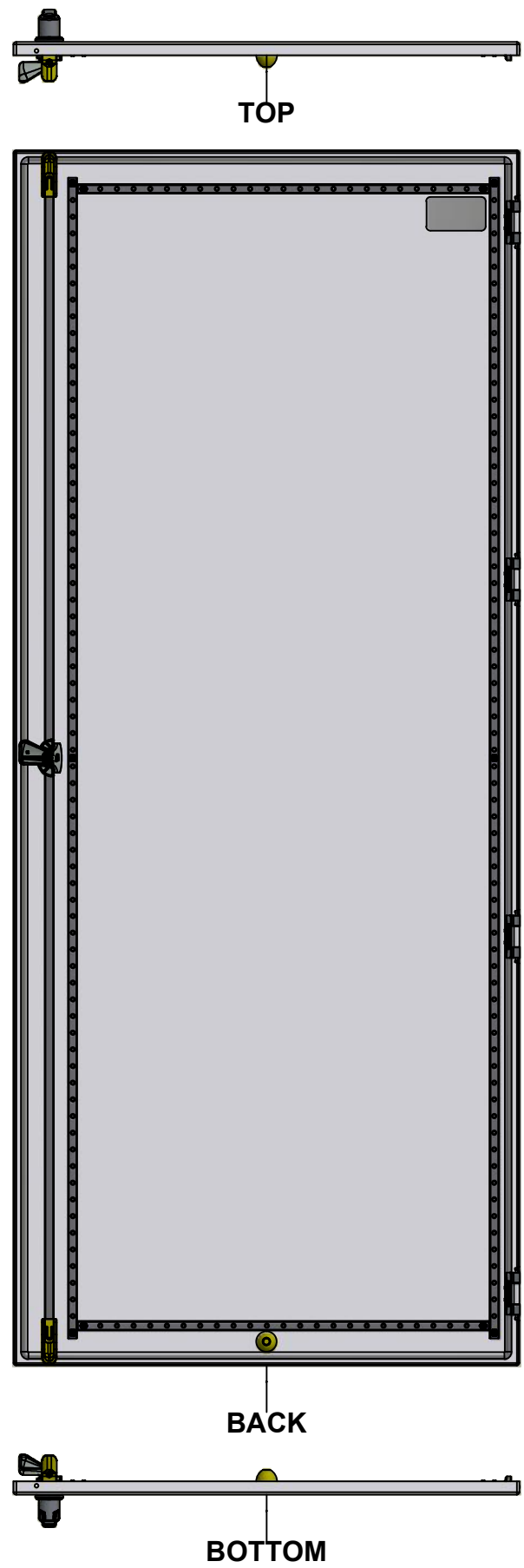

No.	Revisions	Date	By/Par

Isometric View

<p>Tél: (450) 979-4373 Fax: (450) 979-4626 www.exmweb.com</p>		Flatness Aplatissement	
		Max 3.0mm	
Projection			
Customer Client		Date	
Drawn By Dessiné Par BoxCad: BoxCad		Date 2019-09-13	
Material Matière 14 Ga Cold Rolled A1008 CS Type B (1.7mm)			
Color Couleur Asa-61 Grey		Finish Fini Smooth	
Description 5412ES 72" x 30" Cover			Detail Rev.
Part Number Numéro Pièce 5412ES723012NOIPC		Rev. 0	7 9

SEE BILL OF MATERIAL ON LAST PAGE

This drawing is confidential and must not be reproduced or used without the consent of EXM

Ce dessin est confidentiel et ne doit pas être reproduit ou utilisé sans le consentement de EXM

STANDARD FEATURES ARE NOT LISTED IN THIS HOLE TABLE

HOLE TABLE - FRONT VIEW (CUSTOM FEATURE ONLY)

CUT-OUT	XDIM	YDIM	DESCRIPTION
1	1.486	1.945	STUD M6 x 18mm (Inside)
2	1.486	69.858	STUD M6 x 18mm (Inside)
3	26.423	69.858	STUD M6 x 18mm (Inside)
4	26.423	1.945	STUD M6 x 18mm (Inside)
5	1.486	35.902	STUD M6 x 18mm (Inside)
6	26.423	35.902	STUD M6 x 18mm (Inside)
7	2.143	2.350	STUD M6 x 18mm (Inside)
8	2.143	69.524	STUD M6 x 18mm (Inside)
9	25.766	69.524	STUD M6 x 18mm (Inside)
10	25.766	2.350	STUD M6 x 18mm (Inside)
11	27.803	66.896	CLOSING BAR STUD (Inside)
12	27.803	4.907	CLOSING BAR STUD (Inside)
13	14.959	1.435	STUD M6 x 18mm (Inside)

14	3.750	68.053	LABEL_EXM (Inside)
15	27.803	35.902	HANDLE 885 ESL2A @ 0.0°

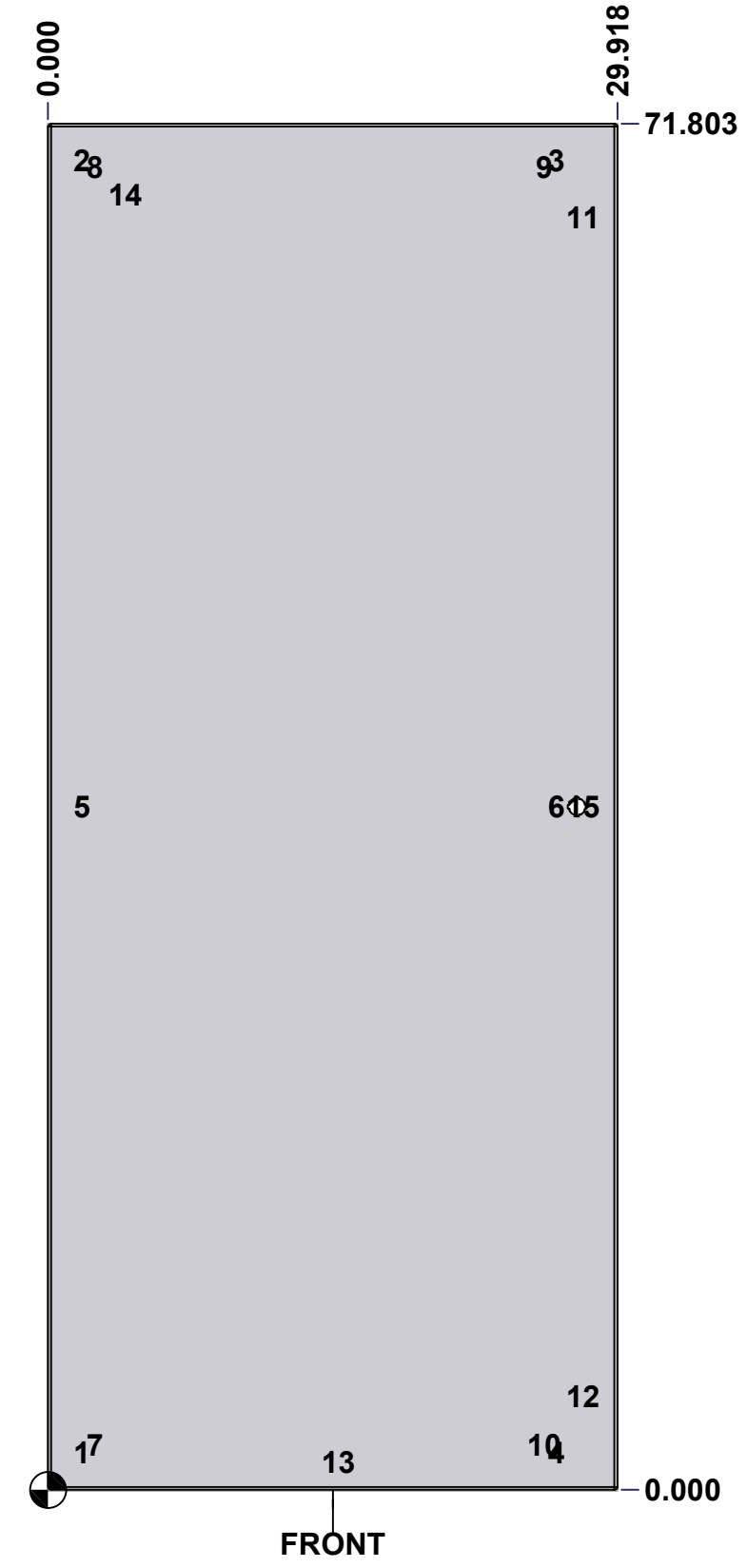

	Description	Status	
	5412ES 72" x 30" Cover	(NULL)	
	Part Number Numéro Pièce	Rev.	
	5412ES723012NOIPC	0	8 9

This drawing is confidential and must not be reproduced or used without the consent of EXM

Ce dessin est confidentiel et ne doit pas être reproduit ou utilisé sans le consentement de EXM

No.	Revisions	Date	By/Par

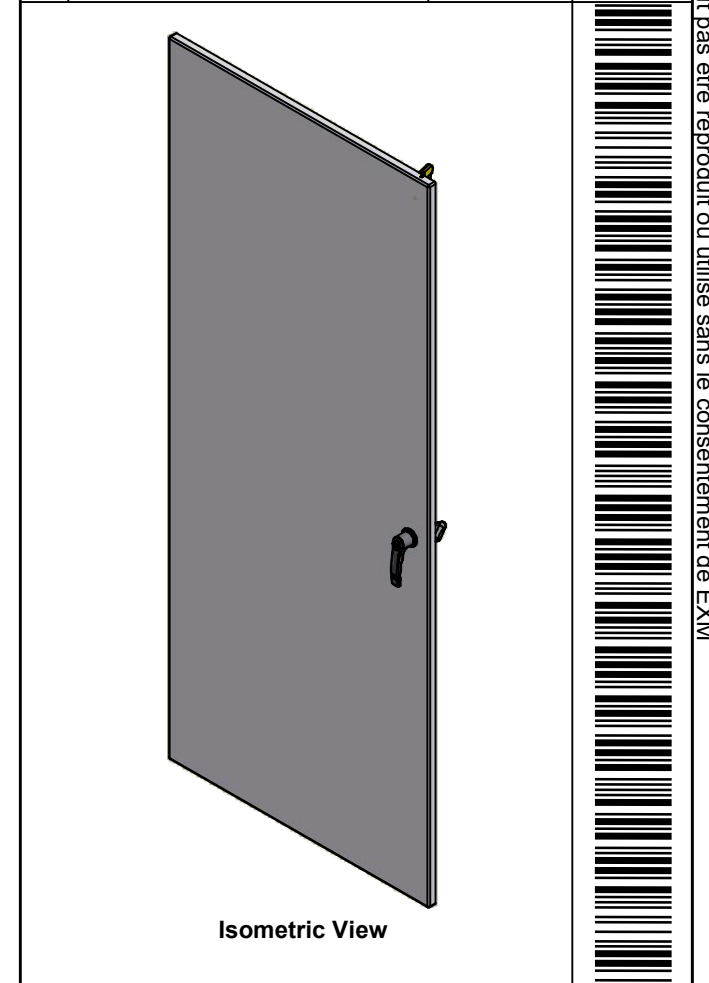

2	STK-Q-90042	4	5412 ES - Cabinet Closing Bar End (Small)
2	STK-Q-45655-72	0	5412 ES - Closing Bar
1	STK-Q-50536	13	5412 ES - Handle Cam Clockwise (Grip 32mm)
1	885 ESL2A	4	5412 ES Key Lock L-Handle (3 Pts)
1	STK-S-00100	0	3.5" x 2" Silver Milar Flexcon Sticker
1	STK-P-02400S	0	Powder Paint (Asa-61 Grey / Smooth)
1	STK-Q-46515	3	5412 ES Door Support with Brass Insert
2	STK-Q-46025-30-3	4	5412 ES Horizontal Door Stiffener 30" (3Pts)
2	STK-Q-46020-72	5	5412 ES Vertical Door Stiffener 72"
2	STK-Q-16405	6	Guide Stud - Small (No Paint Cap Required)
11	STK-Q-16055	1	M6 x 18mm Stud (No Paint Cap Required)
1	5412ES723012NOIPG	0	5412ES 72" x 30" Cover Gasket Part
1	5412ES723012NOIPC-P	0	5412ES 72" x 30" Cover Part
4	STK-K-09800	10	5412 ES Hinge with 2 Captive Hinge Pins
10	STK-Q-07220	1	M6 Nylon Insert Lock Nut

Qty	Part Name	Rev	Description
Parts List			

 Tél: (450) 979-4373 Fax: (450) 979-4626 www.exmweb.com		Flatness Aplatissement	
		Max 3.0mm	
Customer Client		Date	
Drawn By Dessiné Par		Date 2019-09-13	
Material Matière		14 Ga Cold Rolled A1008 CS Type B (1.7mm)	
Color Couleur		Asa-61 Grey	Finish Fini Smooth
Description			Detail Rev.
5412ES 72" x 30" Cover			
Part Number Numéro Pièce		Rev.	9
5412ES723012NOIPC		0	9