

This drawing is confidential and must not be reproduced or used without the consent of EXM

Ce dessin est confidentiel et ne doit pas être reproduit ou utilisé sans le consentement de EXM



TOP



BACK

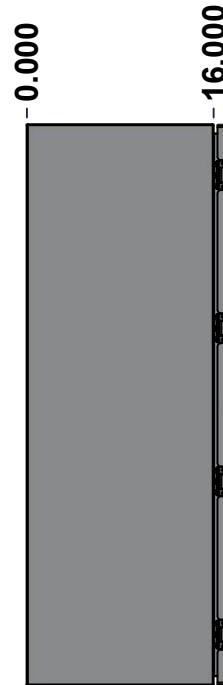

LEFT

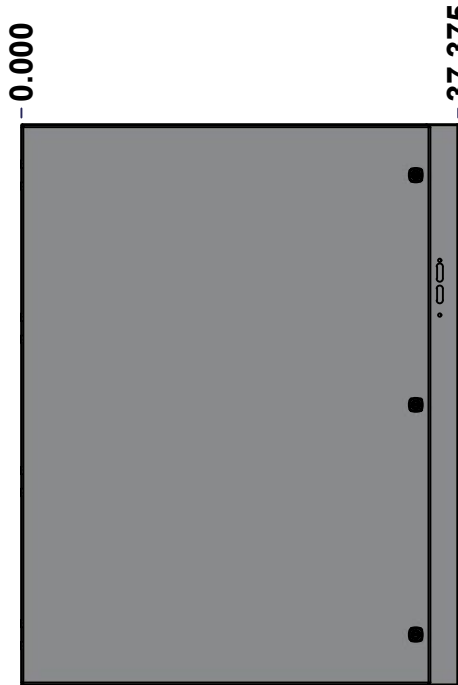

FRONT

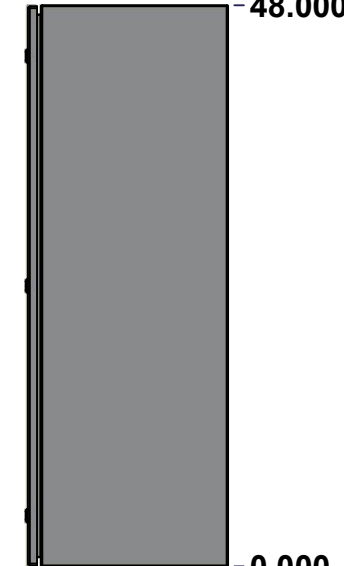

RIGHT



BOTTOM

No.	Revisions	Date	By/Par

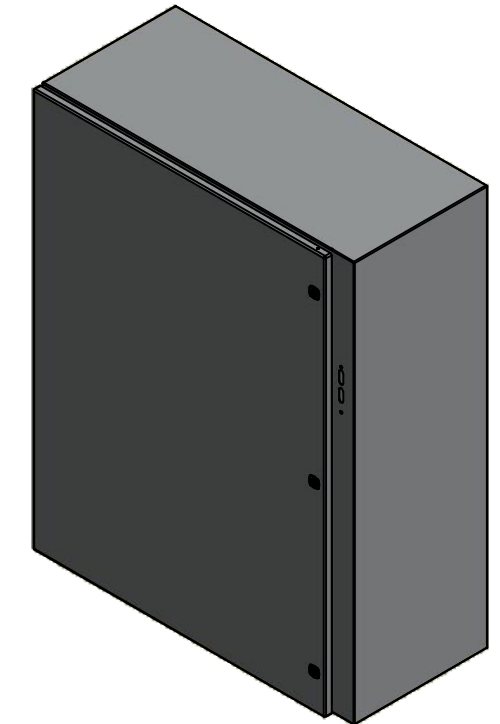

Isometric View



Tél: (450) 979-4373  
 Fax: (450) 979-4626  
[www.exmweb.com](http://www.exmweb.com)

Flatness  
Aplatissement

Max 3.0mm

Projection

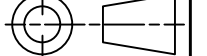

Customer Client	Date
Drawn By / Dessiné Par: BoxCad: BoxCad	Date: 10/10/2014
Material / Matière: 14 Ga Cold Rolled A1008 CS Type B (1.7mm)	

Color / Couleur: Asa-61 Grey	Finish / Fini: Smooth
------------------------------	-----------------------

Description: 5412ESA 48" x 37.375" x 16" Assembly	Detail Rev.
---	-------------

Part Number / Numéro Pièce: 5412ESA483716	Rev. 0	1
---	--------	---

SEE BILL OF MATERIAL ON LAST PAGE

This drawing is confidential and must not be reproduced or used without the consent of EXM

Ce dessin est confidentiel et ne doit pas être reproduit ou utilisé sans le consentement de EXM

NOTE	
ITEM	DESCRIPTION
1	NEMA 4/12 Enclosure
2	C/W Standard ground studs on box and cover
3	C/W Standard door stiffener
4	C/W Standard inner panel (Included)
5	C/W Standard inner panel mounting studs

No.	Revisions	Date	By/Par

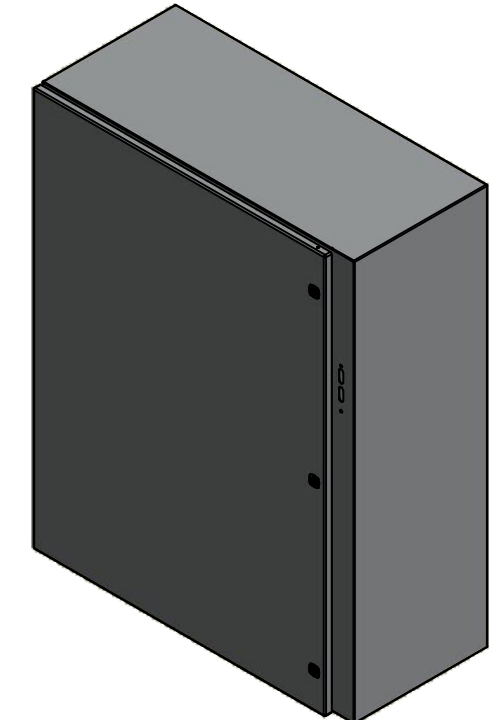

Isometric View

PACKING		
ITEM	QTY	DESCRIPTION
Cardboard sleeve	2	Top and Bottom
Cardboard strip	2	Between back of enclosure and inner panel
Plastic bag	1	To protect cover surface and inside gasket
Cardboard corner	4	To reinforced for the plastic strap tightening
Plastic strap - Black	2	To Squeeze 2 cardboard sleeve together
Packaging label	3	White label with PN
Plastic strap- Green	2	To secure the enclosure to the wood pallet
Wood Pallet	1	2" deeper and 3" larger than enclosure size

1	STK-K-01800	5	5412 ES Accessory Kit
1	5412ESA483716C	0	5412ESA 48" x 37.375" Cover
8	STK-Q-07310	2	Flange Lock Nut M8
1	881 SP4836G	0	881 SP - Inner Panel
8	STK-Q-07610	8	M8 Plastic Spacer 22.2mm
1	5412ESA483716B	0	5412ESA 48" x 37.375" x 16" Body
4	STK-Q-04050-07	7	M6 x 7mm Hexagon Socket Head Machine Screw with Nyseal
Qty	Part Number	Rev	Description
Parts List			

	Tél: (450) 979-4373 Fax: (450) 979-4626 <a href="http://www.exmweb.com">www.exmweb.com</a>	Flatness Aplatissement Max 3.0mm
	Projection 	Customer Client Date
Drawn By Dessiné Par BoxCad: BoxCad	Date 10/10/2014	Material Matière 14 Ga Cold Rolled A1008 CS Type B (1.7mm)
Color Couleur Asa-61 Grey	Finish Fini Smooth	Description 5412ESA 48" x 37.375" x 16" Assembly
Part Number Numéro Pièce <b>5412ESA483716</b>	Rev. <b>0</b>	Detail Rev. 2 9

This drawing is confidential and must not be reproduced or used without the consent of EXM

Ce dessin est confidentiel et ne doit pas être reproduit ou utilisé sans le consentement de EXM



TOP



BACK



BOTTOM

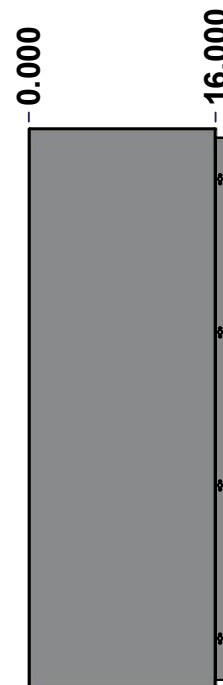

LEFT

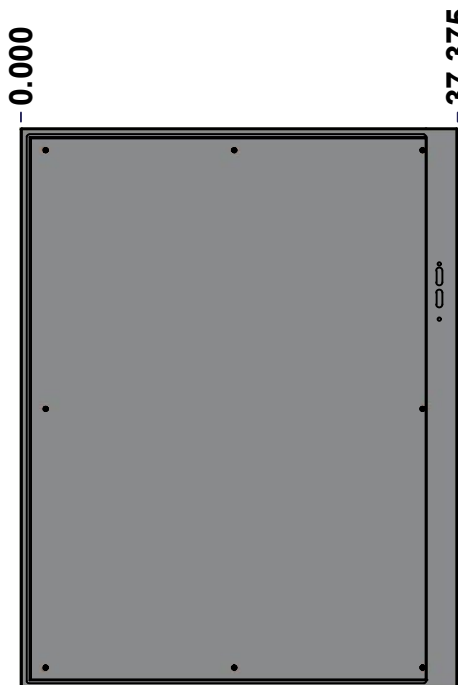

FRONT

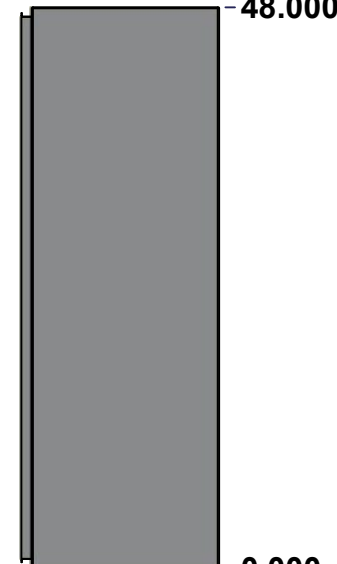

RIGHT

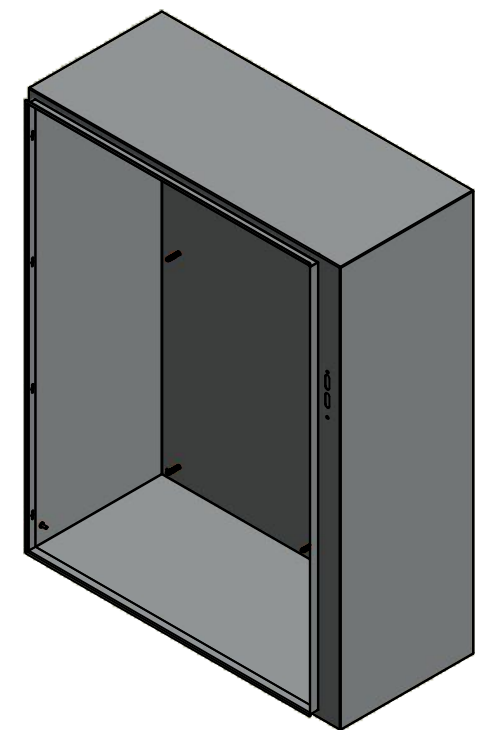

Isometric View

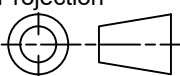

No.	Revisions	Date	By/Par

 Tél: (450) 979-4373 Fax: (450) 979-4626 <a href="http://www.exmweb.com">www.exmweb.com</a>		Flatness Aplatissement Max 3.0mm Projection 
Customer Client	Date	
Drawn By Dessiné Par	BoxCad: BoxCad	Date 10/10/2014
Material Matière	14 Ga Cold Rolled A1008 CS Type B (1.7mm)	
Color Couleur	Asa-61 Grey	Finish Fini Smooth
Description	Detail Rev.	
5412ESA 48" x 37.375" x 16" Body		
Part Number Numéro Pièce	Rev.	3
<b>5412ESA483716B</b>	<b>0</b>	9

SEE BILL OF MATERIAL ON LAST PAGE

This drawing is confidential and must not be reproduced or used without the consent of EXM

Ce dessin est confidentiel et ne doit pas être reproduit ou utilisé sans le consentement de EXM

<b>STANDARD FEATURES ARE NOT LISTED IN THIS HOLE TABLE</b>			
<b>HOLE TABLE - LEFT VIEW (CUSTOM FEATURE ONLY)</b>			
CUT-OUT	XDIM	YDIM	DESCRIPTION
1	14.500	2.000	GND STUD M6 x 16mm (Inside)

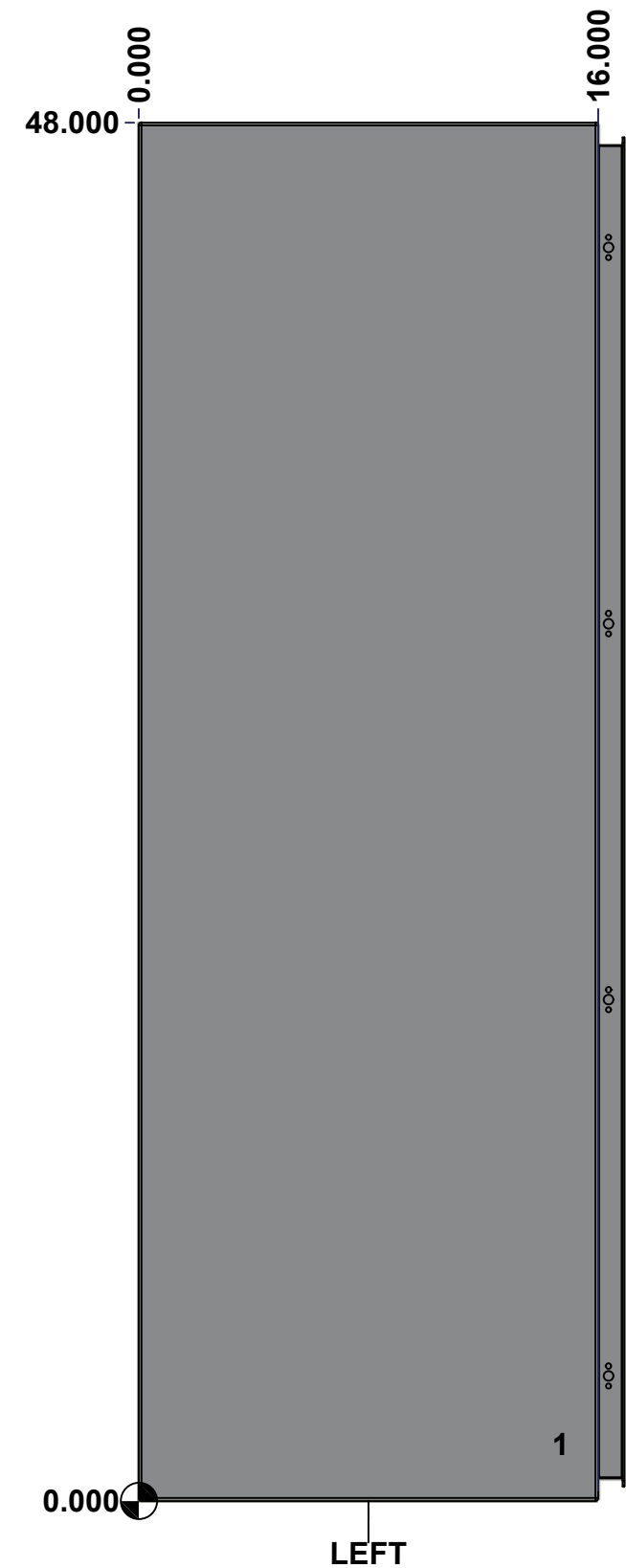

	Description	Status	
	5412ESA 48" x 37.375" x 16" Body	(NULL)	
	Part Number Numéro Pièce	Rev.	
	<b>5412ESA483716B</b>	<b>0</b>	4 9

This drawing is confidential and must not be reproduced or used without the consent of EXM

Ce dessin est confidentiel et ne doit pas être reproduit ou utilisé sans le consentement de EXM

**STANDARD FEATURES ARE NOT LISTED IN THIS HOLE TABLE**

**HOLE TABLE - BACK VIEW (CUSTOM FEATURE ONLY)**

CUT-OUT	XDIM	YDIM	DESCRIPTION
1	3.000	1.875	IP STUD M8 x 35mm (Inside)
2	3.000	46.125	IP STUD M8 x 35mm (Inside)
3	35.250	46.125	IP STUD M8 x 35mm (Inside)
4	35.250	1.875	IP STUD M8 x 35mm (Inside)
5	3.000	24.000	IP STUD M8 x 35mm (Inside)
6	35.250	24.000	IP STUD M8 x 35mm (Inside)
7	19.125	1.875	IP STUD M8 x 35mm (Inside)
8	19.125	46.125	IP STUD M8 x 35mm (Inside)
-----			
9	36.625	0.750	RND Ø0.390
10	36.625	47.250	RND Ø0.390
11	0.750	47.250	RND Ø0.390
12	0.750	0.750	RND Ø0.390

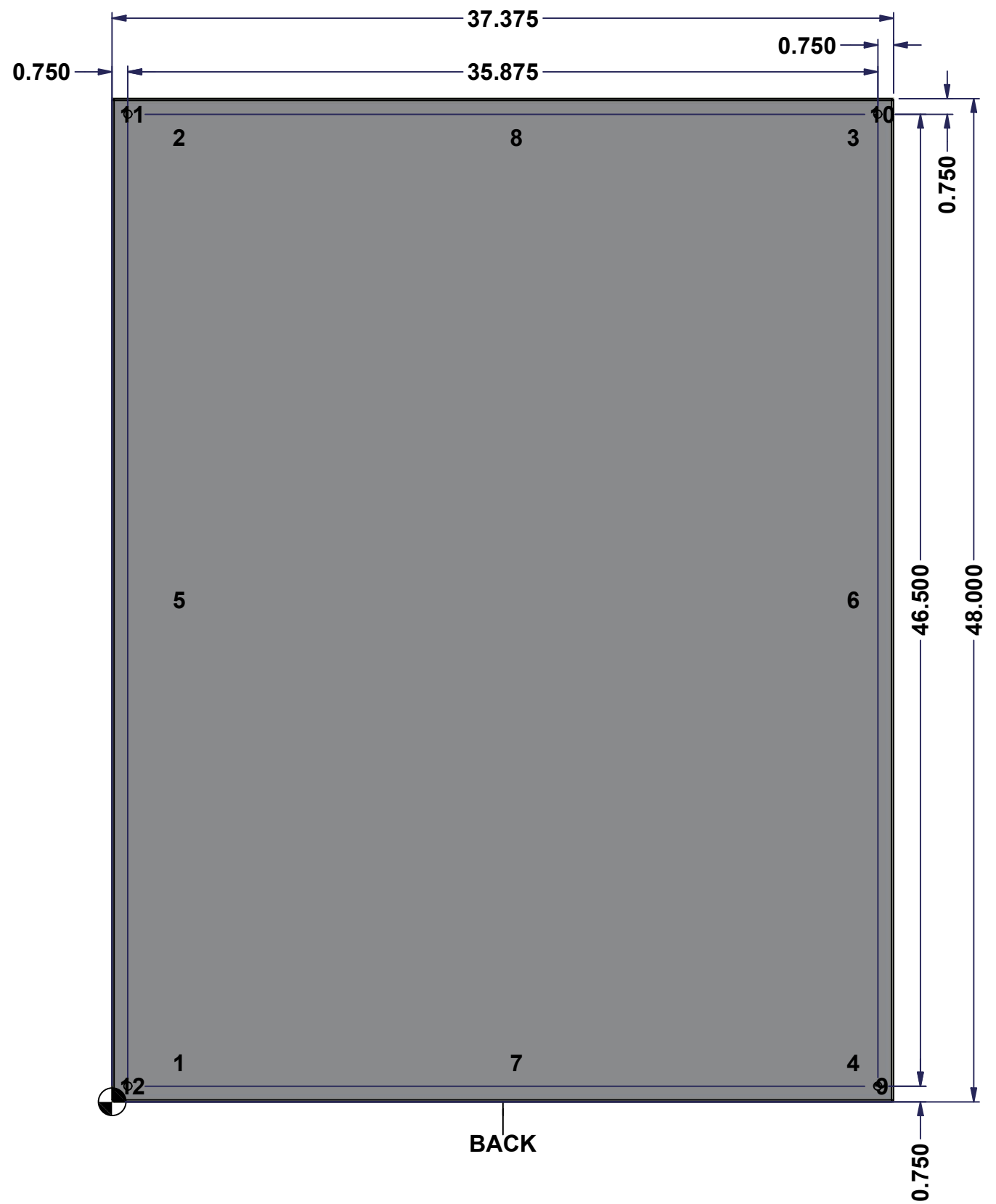

	Description	Status	
	5412ESA 48" x 37.375" x 16" Body	(NULL)	
	Part Number	Rev.	5
	Numéro Pièce	<b>0</b>	9
		<b>5412ESA483716B</b>	

This drawing is confidential and must not be reproduced or used without the consent of EXM

Ce dessin est confidentiel et ne doit pas être reproduit ou utilisé sans le consentement de EXM

No.	Revisions	Date	By/Par

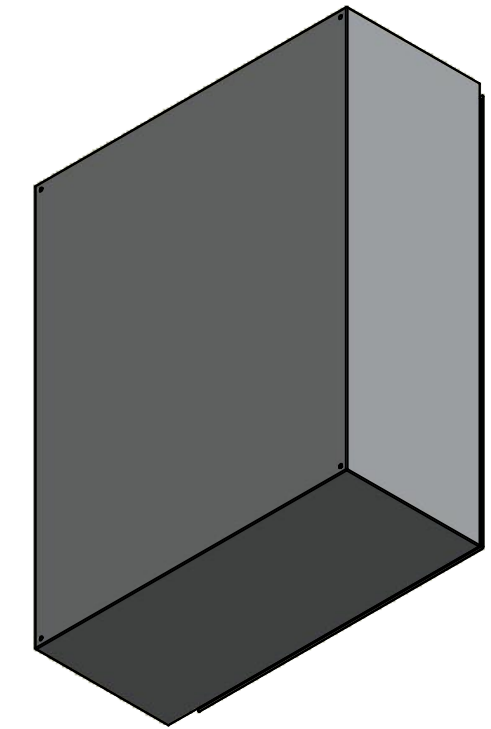

Isometric View

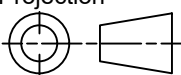

 Tél: (450) 979-4373 Fax: (450) 979-4626 <a href="http://www.exmweb.com">www.exmweb.com</a>	Flatness Aplatissement	Max 3.0mm
	Projection	
Customer Client	Date	
Drawn By Dessiné Par	BoxCad: BoxCad	Date 10/10/2014
Material Matière	14 Ga Cold Rolled A1008 CS Type B (1.7mm)	
Color Couleur	Asa-61 Grey	Finish Fini Smooth
Description		Detail Rev.
5412ESA 48" x 37.375" x 16" Body		
Part Number Numéro Pièce	Rev.	6
<b>5412ESA483716B</b>	<b>0</b>	9

Qty	Part Number	Rev	Description
1	STK-Q-16080	0	Ground Stud M6 x 16mm
1	STK-P-02400S	0	Powder Paint (Asa-61 Grey / Smooth)
8	STK-Q-16005	1	Stud M8 x 35 (No Paint Cap Required)
1	5412ESA483716B-P	0	5412ESA 48" x 37.375" x 16" Body Part
Parts List			

This drawing is confidential and must not be reproduced or used without the consent of EXM

Ce dessin est confidentiel et ne doit pas être reproduit ou utilisé sans le consentement de EXM

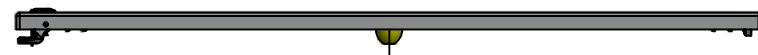

TOP

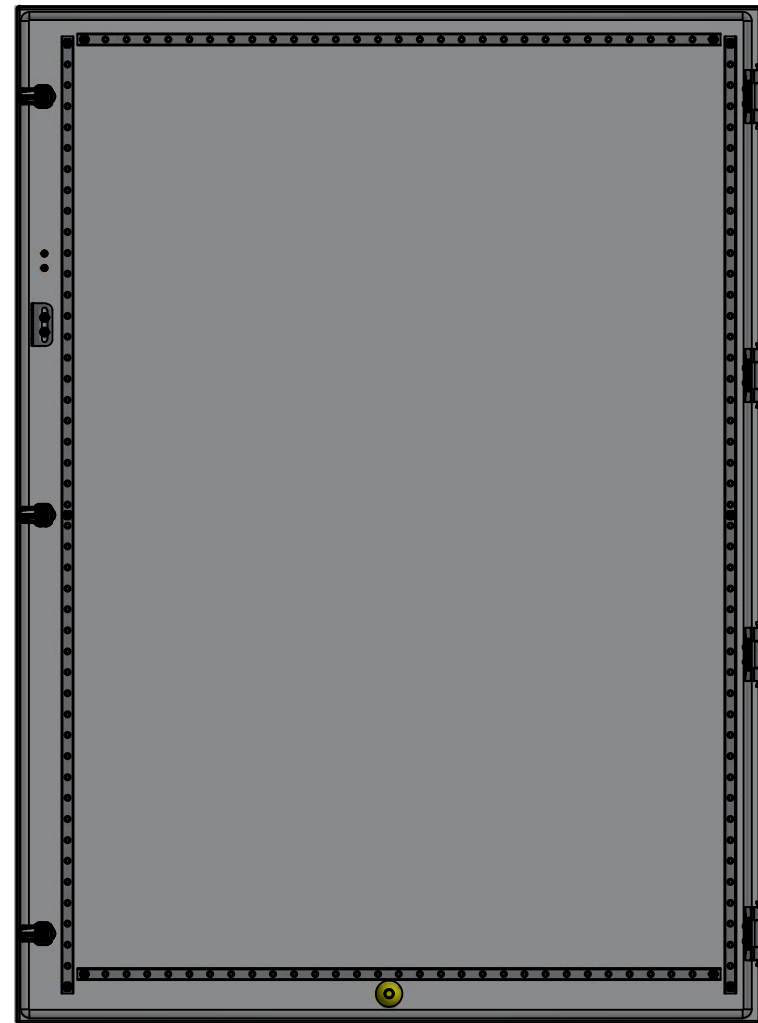

BACK

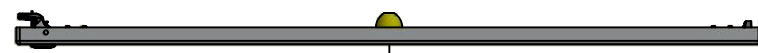

BOTTOM

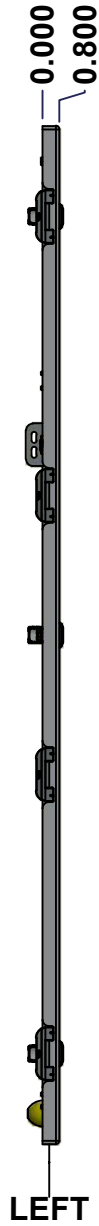

LEFT

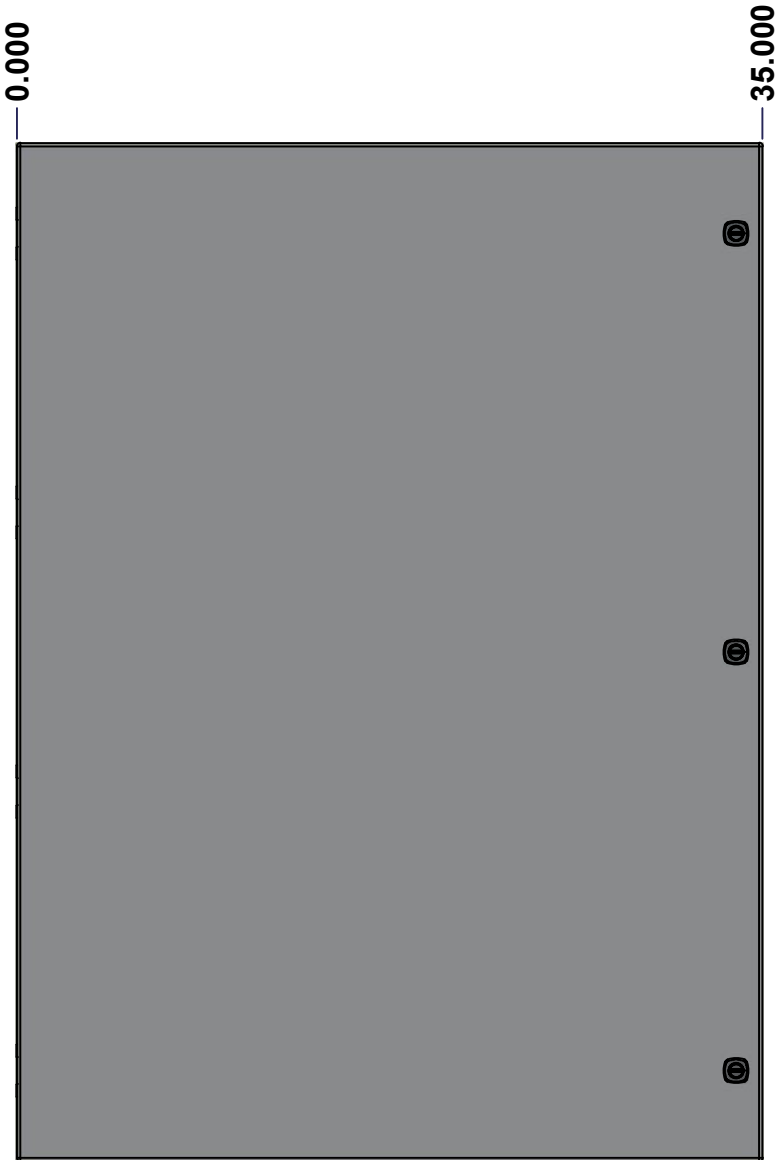

FRONT

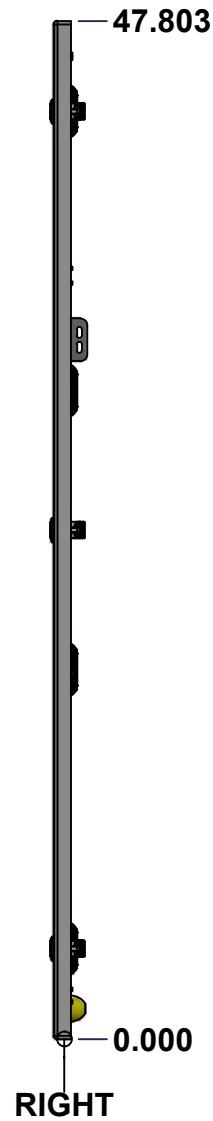

RIGHT

No.	Revisions	Date	By/Par

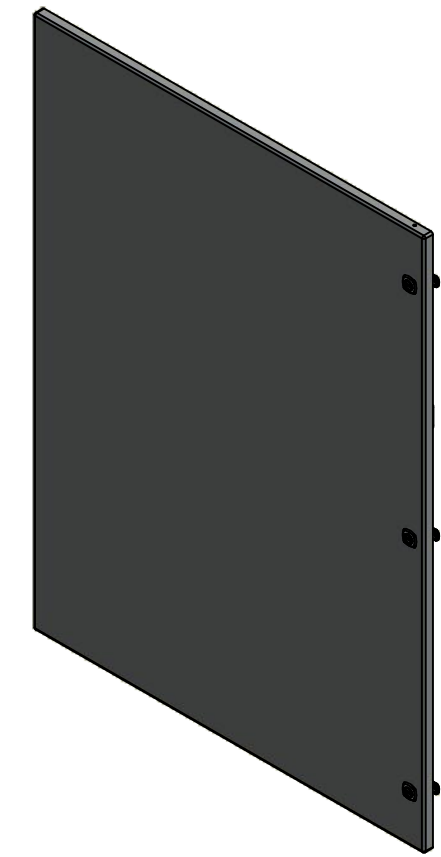

Isometric View

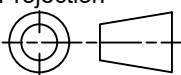

 Tél: (450) 979-4373 Fax: (450) 979-4626 <a href="http://www.exmweb.com">www.exmweb.com</a>		Flatness Aplatissement Max 3.0mm Projection 
Customer Client	Date	
Drawn By Dessiné Par	BoxCad: BoxCad	Date 10/10/2014
Material Matière	14 Ga Cold Rolled A1008 CS Type B (1.7mm)	
Color Couleur	Asa-61 Grey	Finish Fini Smooth
Description	Detail Rev.	
5412ESA 48" x 37.375" Cover		
Part Number Numéro Pièce	Rev. 7	9
5412ESA483716C		0

SEE BILL OF MATERIAL ON LAST PAGE

This drawing is confidential and must not be reproduced or used without the consent of EXM

Ce dessin est confidentiel et ne doit pas être reproduit ou utilisé sans le consentement de EXM

**STANDARD FEATURES ARE NOT LISTED IN THIS HOLE TABLE**

**HOLE TABLE - FRONT VIEW (CUSTOM FEATURE ONLY)**

CUT-OUT	XDIM	YDIM	DESCRIPTION
1	1.486	1.756	STUD M6 x 18mm (Inside)
2	1.486	46.047	STUD M6 x 18mm (Inside)
3	31.194	46.047	STUD M6 x 18mm (Inside)
4	31.194	1.756	STUD M6 x 18mm (Inside)
5	1.486	23.902	STUD M6 x 18mm (Inside)
6	31.194	23.902	STUD M6 x 18mm (Inside)
7	2.560	2.350	STUD M6 x 18mm (Inside)
8	2.560	46.228	STUD M6 x 18mm (Inside)
9	30.120	46.228	STUD M6 x 18mm (Inside)
10	30.120	2.350	STUD M6 x 18mm (Inside)
11	17.500	1.435	STUD M6 x 18mm (Inside)
12	33.675	36.178	STUD M6 x 18mm (Inside)
13	33.675	35.491	STUD M6 x 18mm (Inside)
14	33.675	33.178	STUD M6 x 18mm (Inside)
15	33.675	32.491	STUD M6 x 18mm (Inside)
-----			
16	33.750	43.553	LOCK 880 SCQ4-SL @ 0.0°
17	33.750	23.902	LOCK 880 SCQ4-SL @ 0.0°
18	33.750	4.250	LOCK 880 SCQ4-SL @ 0.0°

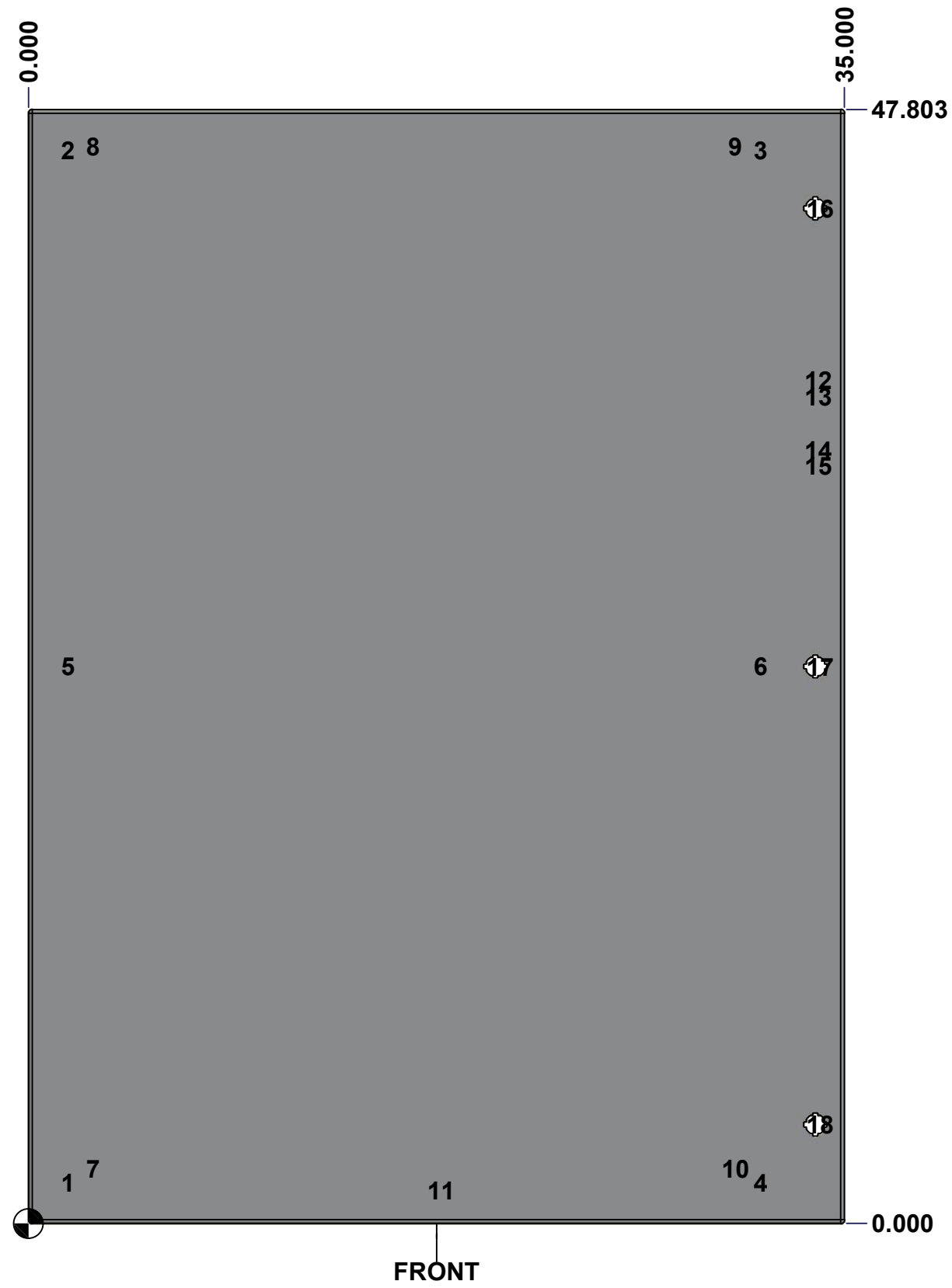

	Description	Status
	5412ESA 48" x 37.375" Cover	(NULL)
Part Number Numéro Pièce <b>5412ESA483716C</b>	Rev.	8
	<b>0</b>	9



This drawing is confidential and must not be reproduced or used without the consent of EXM

Ce dessin est confidentiel et ne doit pas être reproduit ou utilisé sans le consentement de EXM

No.	Revisions	Date	By/Par

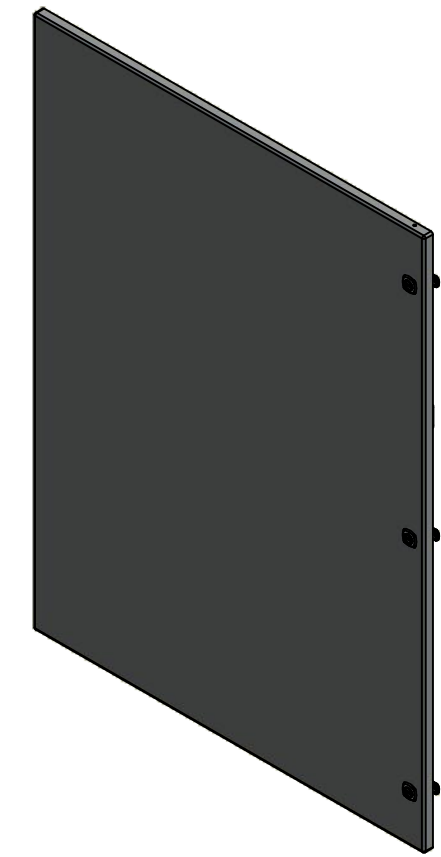

Isometric View

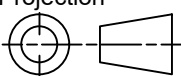

Qty	Part Name	Rev	Description
1	STK-P-02400S	0	Powder Paint (Asa-61 Grey / Smooth)
1	STK-Q-46515	3	5412 ES Door Support with Brass Insert
1	STK-Q-77350	1	5500 ESA Disconnect Door Bracket
2	STK-Q-46025-36-3	0.1. 1	5412 ES Horizontal Door Stiffener 36" (3 Pts)
2	STK-Q-46020-48	5	5412 ES Vertical Door Stiffener 48"
15	STK-Q-16055	1	M6 x 18mm Stud (No Paint Cap Required)
1	5412ESA483716G	0	5412ESA 48" x 37.375" Cover Gasket
1	5412ESA483716C-P	0	5412ESA 48" x 37.375" Cover Part
4	STK-K-09800	10	5412 ES Hinge with 2 Captive Hinge Pins
3	880 SCQ4-SL	6	5412 ES 1/4 Turn Lock
12	STK-Q-07220	1	M6 Nylon Insert Lock Nut
Parts List			

 Tél: (450) 979-4373 Fax: (450) 979-4626 <a href="http://www.exmweb.com">www.exmweb.com</a>		Flatness Aplatissement Max 3.0mm Projection 
Customer Client	Date	
Drawn By Dessiné Par	BoxCad: BoxCad	Date 10/10/2014
Material Matière	14 Ga Cold Rolled A1008 CS Type B (1.7mm)	
Color Couleur	Asa-61 Grey	Finish Fini Smooth
Description		Detail Rev.
5412ESA 48" x 37.375" Cover		
Part Number Numéro Pièce	Rev.	9
<b>5412ESA483716C</b>	<b>0</b>	<b>9</b>

This drawing is confidential and must not be reproduced or used without the consent of EXM

Ce dessin est confidentiel et ne doit pas être reproduit ou utilisé sans le consentement de EXM

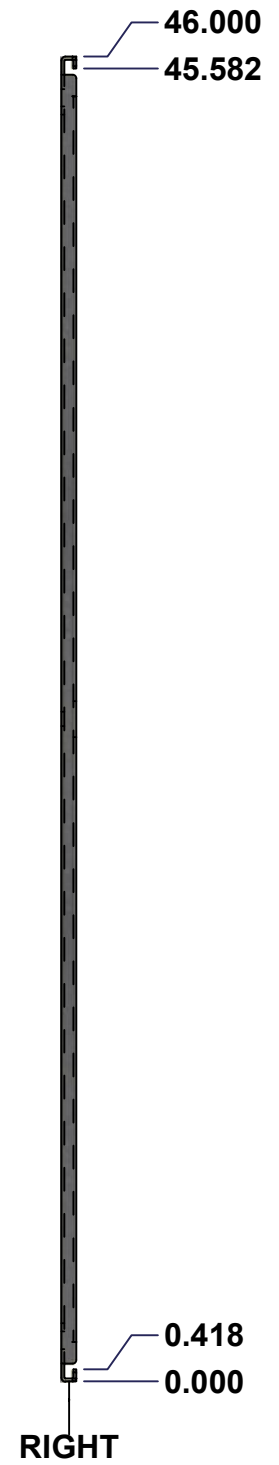
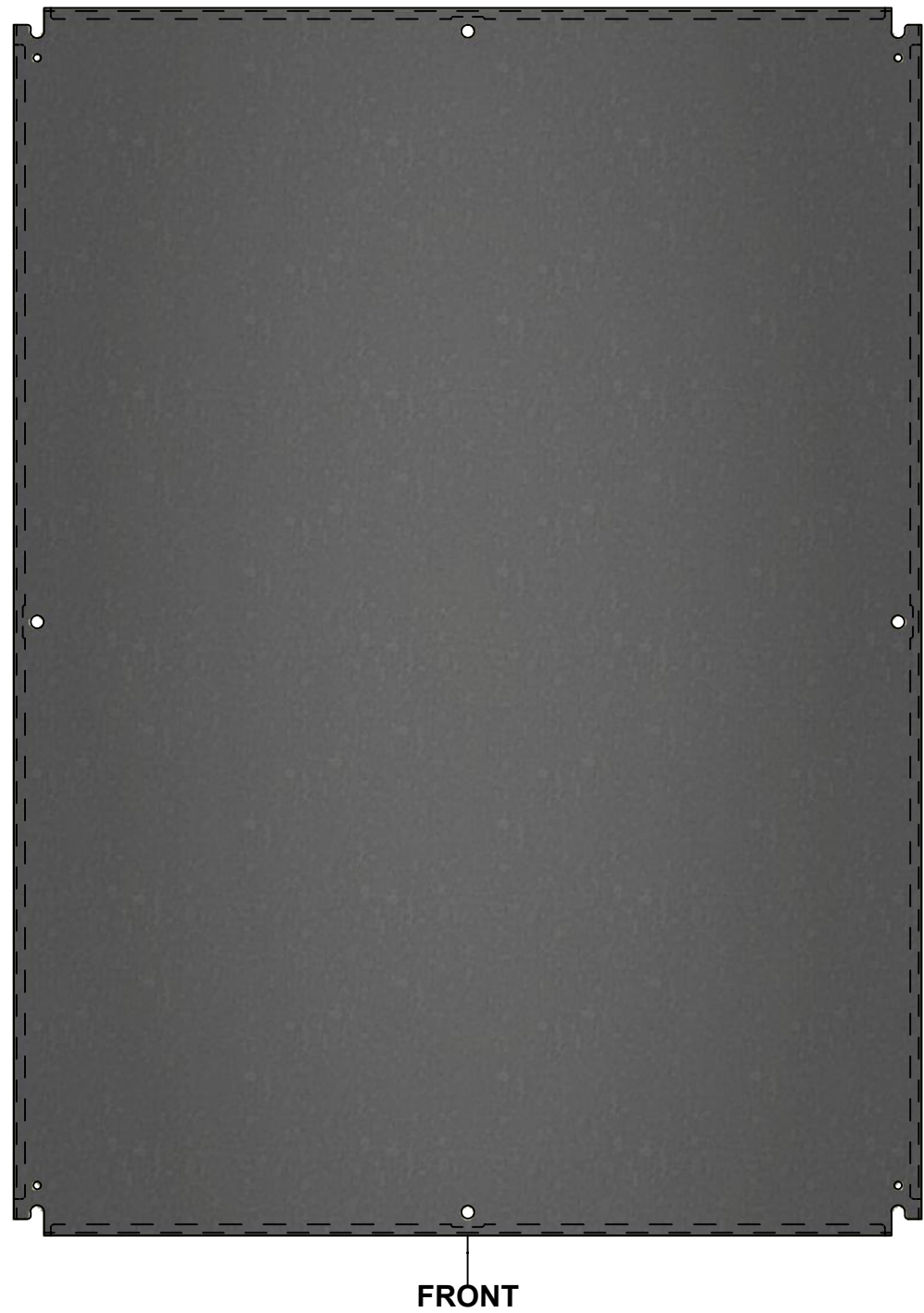
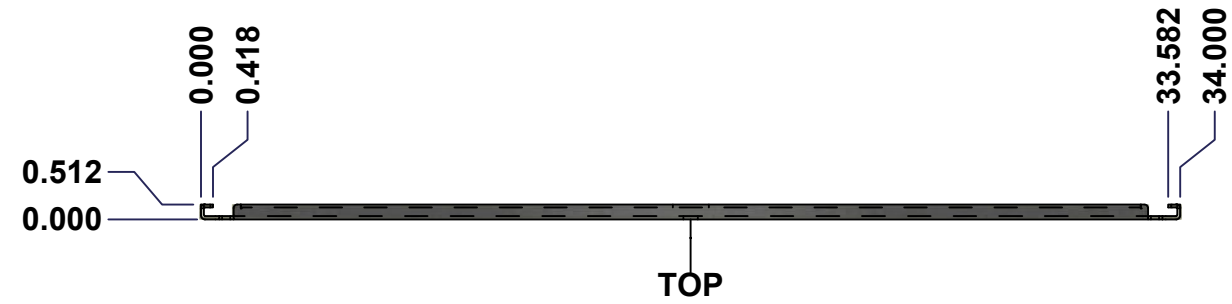

No.	Revisions	Date	By/Par

Isometric View

Tél: (450) 979-4373 Fax: (450) 979-4626 www.exmweb.com	Flatness Aplatissement
	Max 3.0mm
Projection	
Customer Client	Date
Drawn By Dessiné Par BoxCad	Date 1/23/2007
Material Matière	See Part List
Color Couleur	See Part List
Finish Fini	See Part List
Description	Detail Rev.
881 SP - Inner Panel	
Part Number Numéro Pièce	Rev. 1
<b>881 SP4836G</b>	<b>0</b> 2

Qty	Part Number	Rev	Description	Material	Color	Finish
1	881 SP4836G-P	0	881 SP - Inner Panel Part	12 Ga Galvanized	Unpainted	Galvanized

Parts List

This drawing is confidential and must not be reproduced or used without the consent of EXM

Ce dessin est confidentiel et ne doit pas être reproduit ou utilisé sans le consentement de EXM

Table 1			FRONT VIEW
CUT-OUT	XDIM	YDIM	DESCRIPTION
1	17.000	0.875	MTG STUD HOLE (RND Ø0.500)
2	0.875	23.000	MTG STUD HOLE (RND Ø0.500)
3	33.125	23.000	MTG STUD HOLE (RND Ø0.500)
4	17.000	45.125	MTG STUD HOLE (RND Ø0.500)
5	0.875	1.875	GROUND HOLE (RND Ø0.290)
6	33.125	1.875	GROUND HOLE (RND Ø0.290)
7	0.875	44.125	GROUND HOLE (RND Ø0.290)
8	33.125	44.125	GROUND HOLE (RND Ø0.290)

All knockouts are actual size / Les disques défonçables sont grandeur réel

No.	Revisions	Date	By/Par

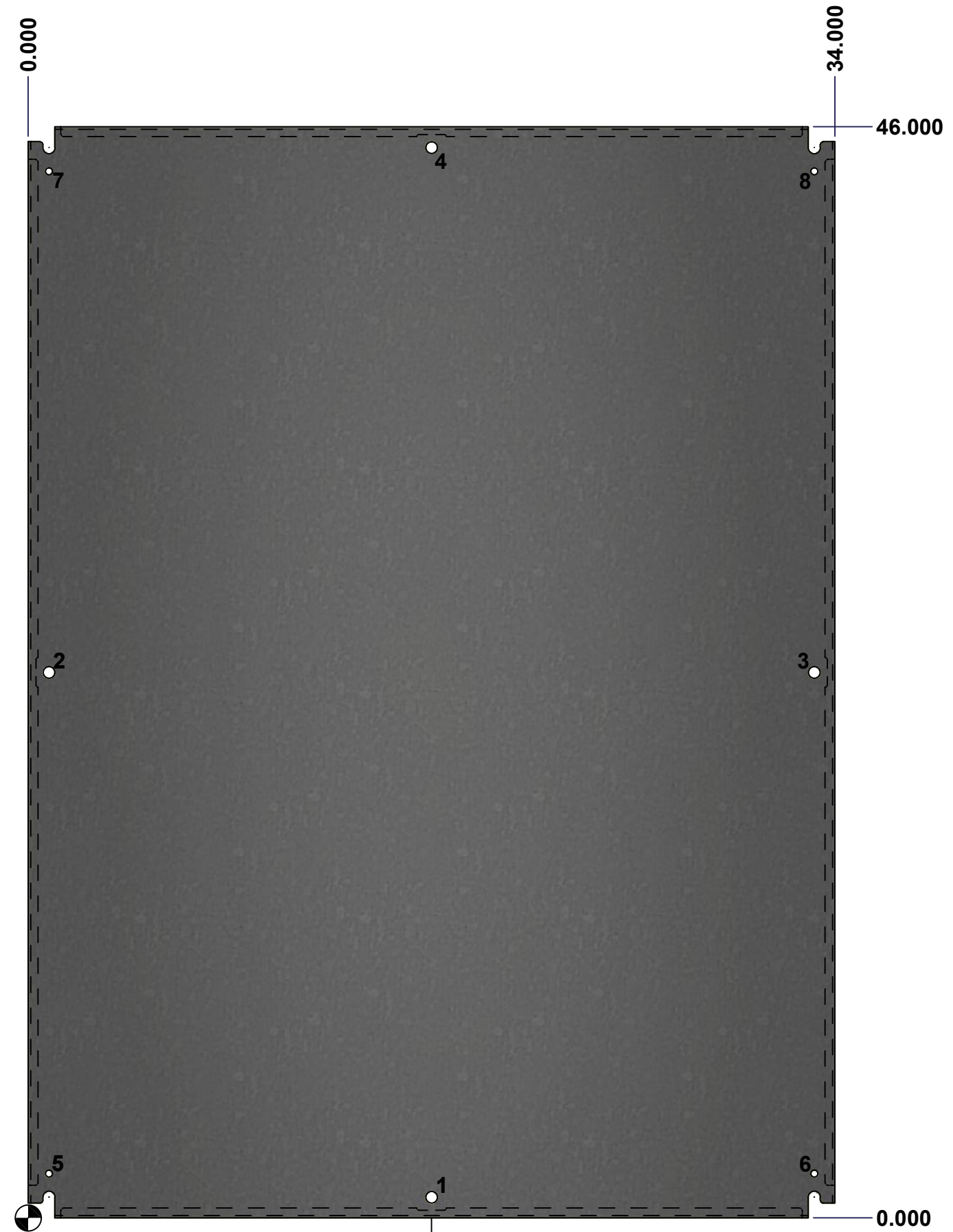

Isometric View



	Tél: (450) 979-4373 Fax: (450) 979-4626 www.exmweb.com	Flatness Aplatissement Max 3.0mm
		Projection 
Customer Client		Date
Drawn By Dessiné Par	BoxCad	Date 1/23/2007
Material Matière	See Part List	
Color Couleur	See Part List	Finish Fini See Part List
Description	881 SP - Inner Panel	
Part Number Numéro Pièce	881 SP4836G	Detail Rev.
	Rev. 0	2 / 2