

This drawing is confidential and must not be reproduced or used without the consent of EXM

Ce dessin est confidentiel et ne doit pas être reproduit ou utilisé sans le consentement de EXM

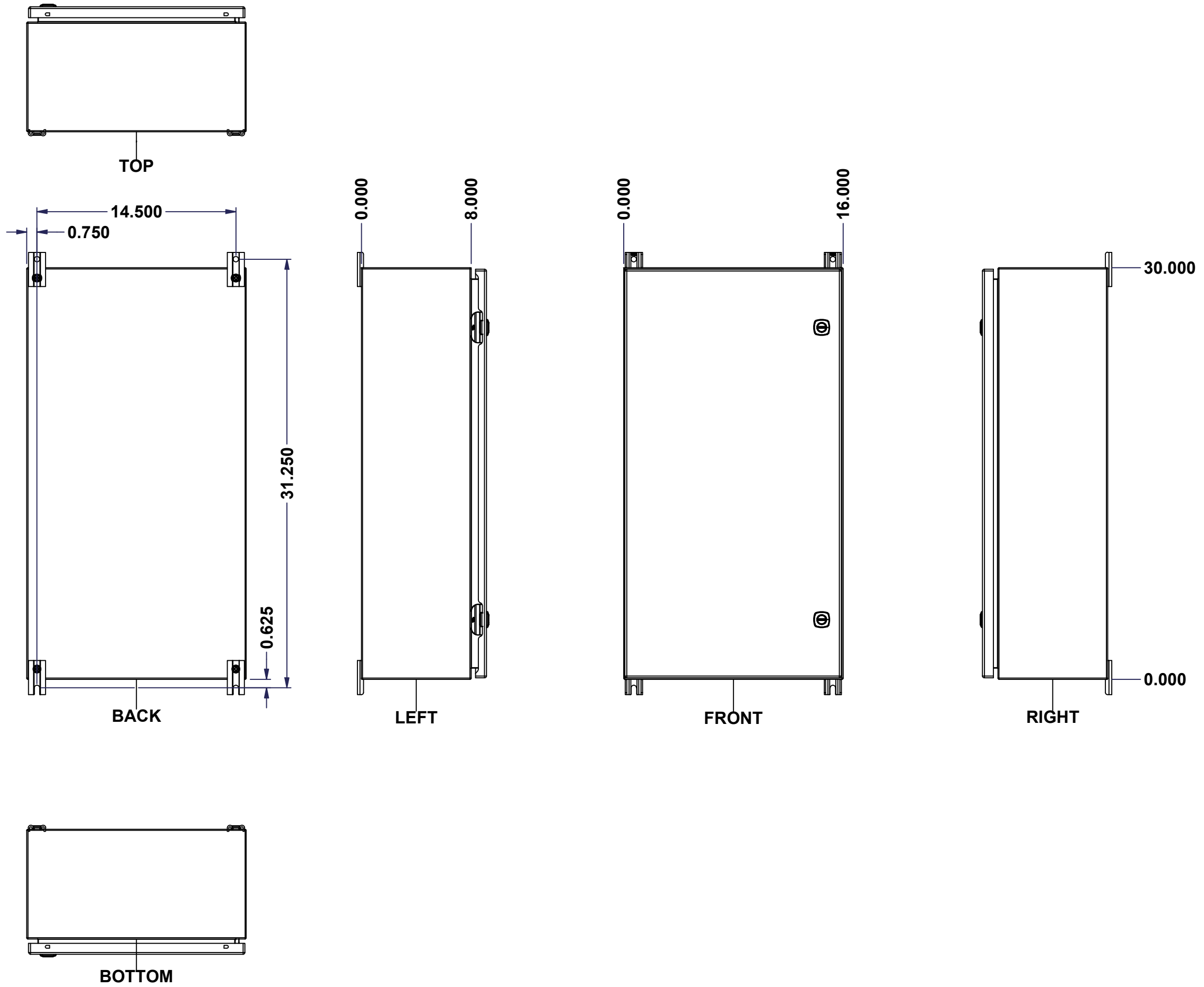

No.	Revisions	Date	By/Par

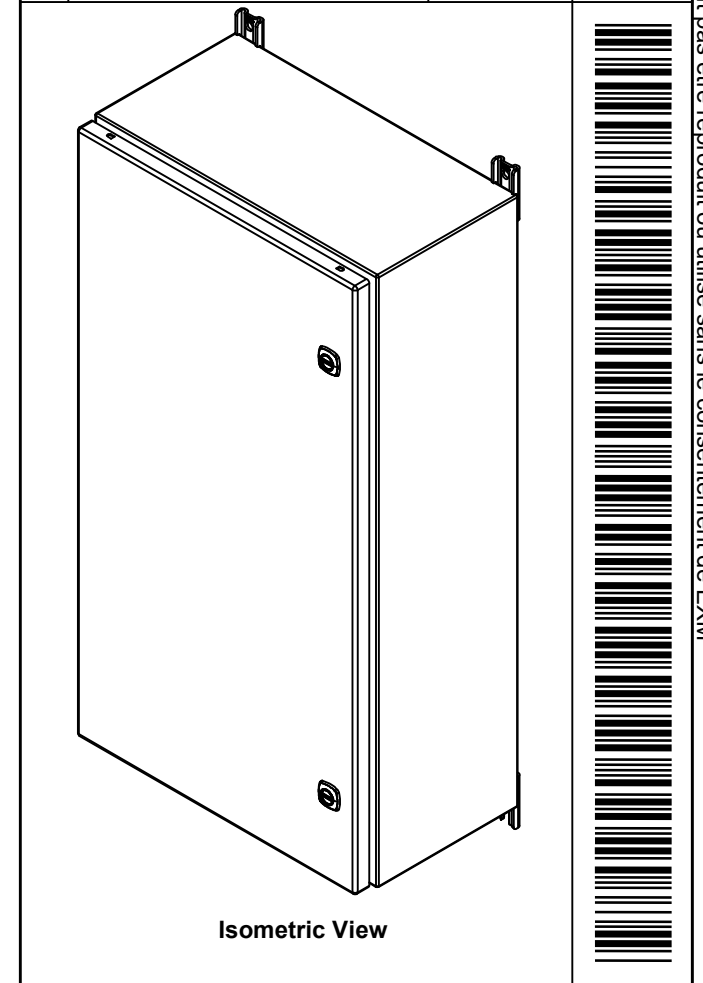

Tél: (450) 979-4373 Fax: (450) 979-4626 <a href="http://www.exmweb.com">www.exmweb.com</a>		Flatness Aplatissement Max 3.0mm Projection 
Customer Client	Date	
Drawn By Dessiné Par	BoxCad: BoxCad	Date 11-Apr-23
Material Matière	16 Ga Cold Rolled A1008 CS Type B (1.4mm)	
Color Couleur	Asa-61 Grey	Finish Fini Smooth
Description	Detail Rev.	
5412ESBU 30" x 16" x 8" Assembly		
Part Number Numéro Pièce	Rev. 0	1 / 16

SEE BILL OF MATERIAL ON LAST PAGE

**5412ESBU301608TH**

This drawing is confidential and must not be reproduced or used without the consent of EXM

Ce dessin est confidentiel et ne doit pas être reproduit ou utilisé sans le consentement de EXM

NOTE	
ITEM	DESCRIPTION
1	NEMA 4/12 Enclosure
2	C/W Standard ground studs on box and cover
3	C/W Standard door stiffener
4	C/W Standard inner panel (Included)
5	C/W Standard inner panel mounting studs
6	C/W 885 ESMF3_OPEN Sold separately (Installed)
7	C/W 885 ESMF3_CLOSE Sold separately (Installed)
8	C/W R5 Insulation (Installed by EXM)

No.	Revisions	Date	By/Par

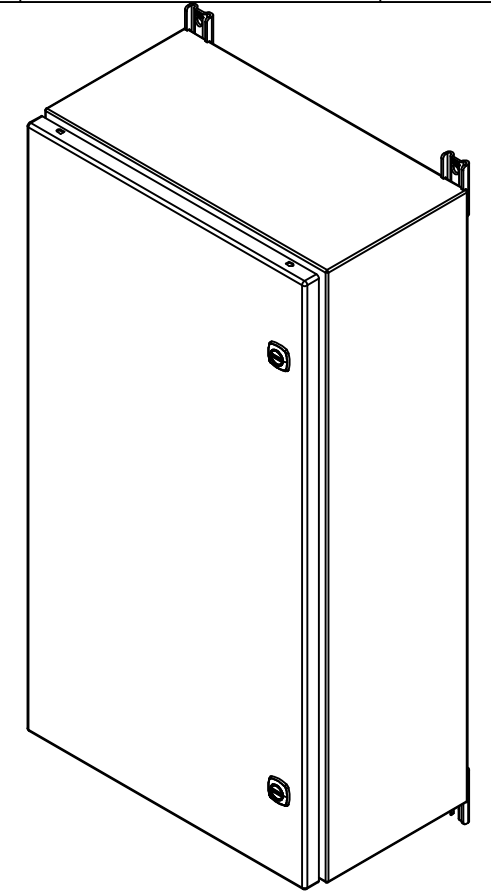

Isometric View

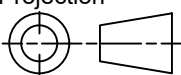

 Tél: (450) 979-4373 Fax: (450) 979-4626 <a href="http://www.exmweb.com">www.exmweb.com</a>	Flatness Aplatissement
	Max 3.0mm
Projection	
Customer Client	Date
Drawn By Dessiné Par BoxCad: BoxCad	Date 11-Apr-23
Material Matière 16 Ga Cold Rolled A1008 CS Type B (1.4mm)	

PACKING		
ITEM	QTY	DESCRIPTION
Cardboard sleeve	2	Top and Bottom
Cardboard strip	2	Between back of enclosure and inner panel
Plastic bag	1	To protect cover surface and inside gasket
Plastic strap - Black	2	To Squeeze the 2 cardboard sleeve together
Packaging label	1	White label with product number

Qty	Part Number	Rev	Description
4	STK-Q-00600	2	M12 to M8 Adaptor
1	881 SP3016G	0	881 SP - Inner Panel
1	STK-K-01800	5	5412 ES Accessory Kit
1	5412ESBU301608THC	0	5412ESBU 30" x 16" Cover
1	5412ESBU301608THB	0	5412ESBU 30" x 16" x 8" Body
4	STK-Q-04050-08	0	M6 x 8mm Hexagon Socket Head Machine Screw
Parts List			

Color Couleur	Asa-61 Grey	Finish Fini	Smooth
Description	5412ESBU 30" x 16" x 8" Assembly		
Part Number Numéro Pièce	5412ESBU301608TH		Rev. 0
			2
			16

This drawing is confidential and must not be reproduced or used without the consent of EXM

Ce dessin est confidentiel et ne doit pas être reproduit ou utilisé sans le consentement de EXM

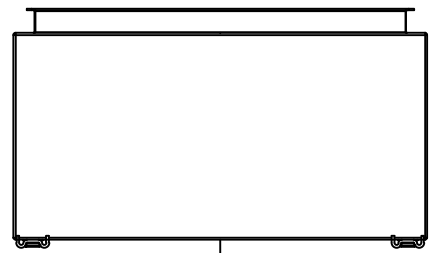

TOP

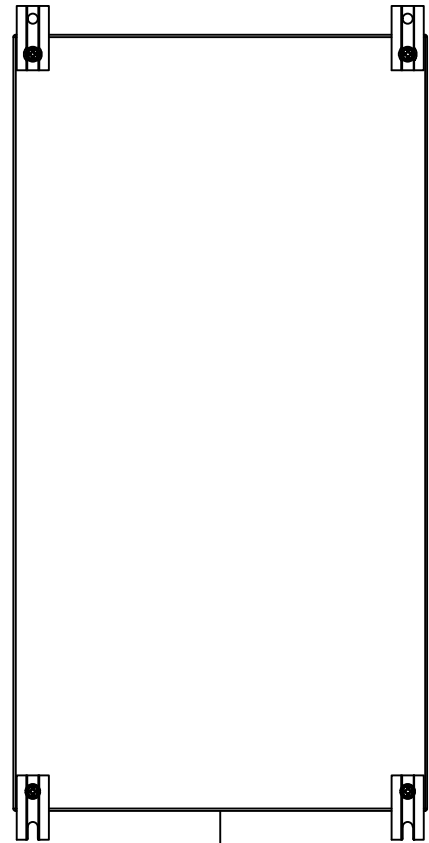

BACK

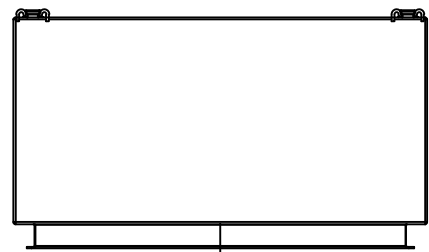

BOTTOM

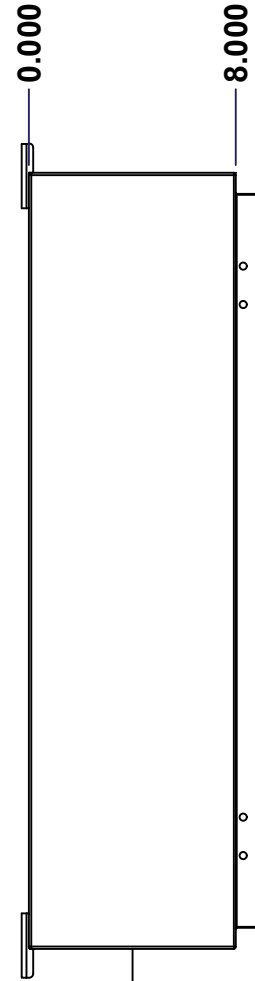

LEFT

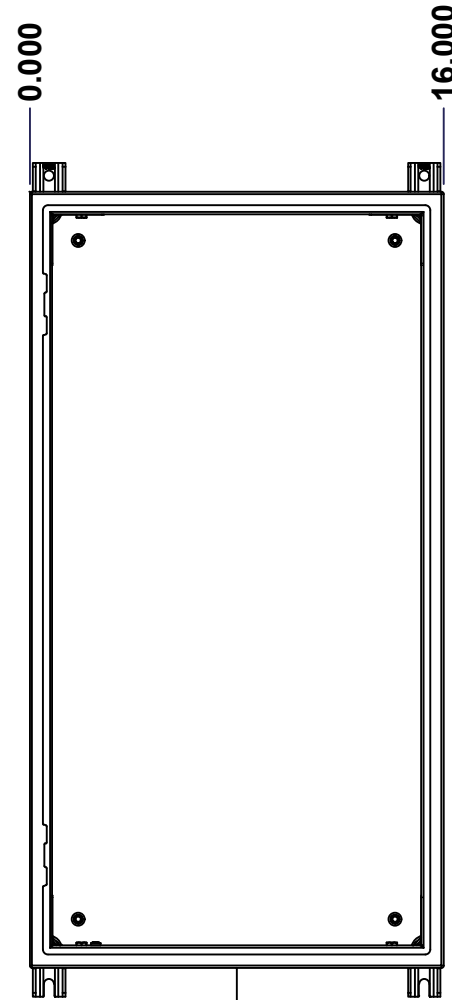

FRONT

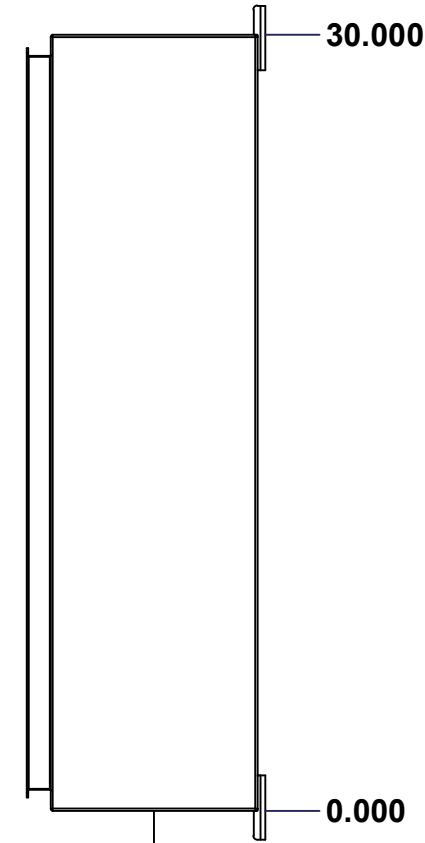

RIGHT

No.	Revisions	Date	By/Par

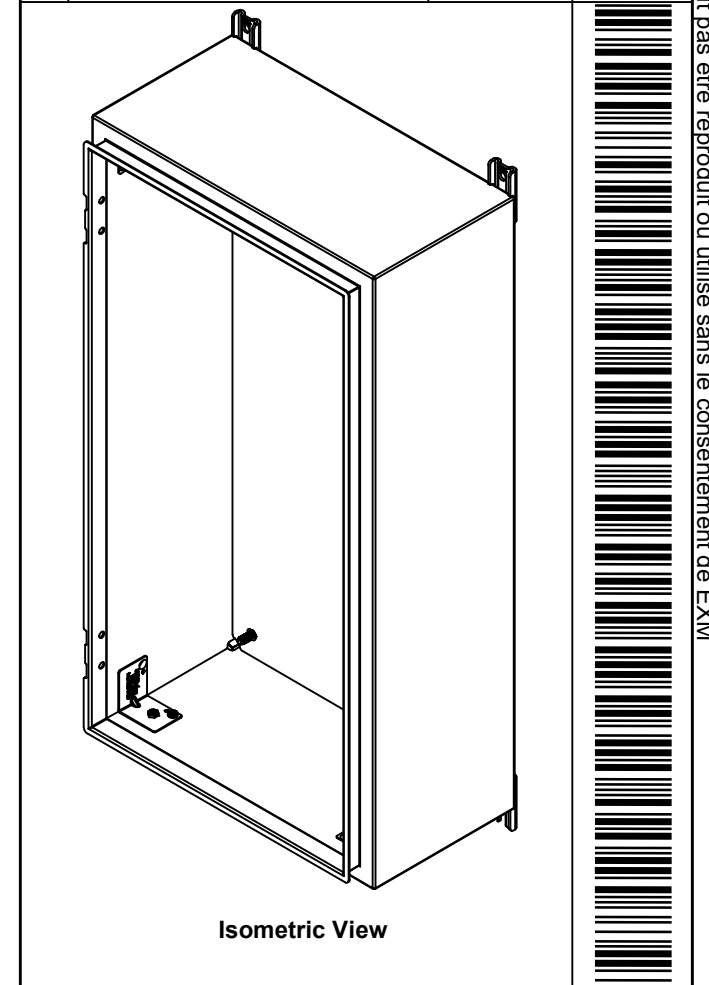

Isometric View

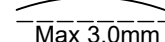
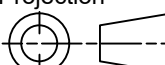

 Tél: (450) 979-4373 Fax: (450) 979-4626 <a href="http://www.exmweb.com">www.exmweb.com</a>		Flatness Aplatissement  Max 3.0mm Projection 
Customer Client	Date	
Drawn By Dessiné Par	BoxCad: BoxCad	Date 11-Apr-23
Material Matière	16 Ga Cold Rolled A1008 CS Type B (1.4mm)	
Color Couleur	Asa-61 Grey	Finish Fini Smooth
Description	Detail Rev.	
5412ESBU 30" x 16" x 8" Body		
Part Number Numéro Pièce	Rev. 3	
SEE BILL OF MATERIAL ON LAST PAGE		
5412ESBU301608THB		0
		16

This drawing is confidential and must not be reproduced or used without the consent of EXM

Ce dessin est confidentiel et ne doit pas être reproduit ou utilisé sans le consentement de EXM

STANDARD FEATURES ARE NOT LISTED IN THIS HOLE TABLE			
HOLE TABLE - TOP VIEW (CUSTOM FEATURE ONLY)			
CUT-OUT	XDIM	YDIM	DESCRIPTION
1	2.000	6.500	INSUL. STUD M6 x 18mm (Inside)
2	14.000	6.500	INSUL. STUD M6 x 18mm (Inside)

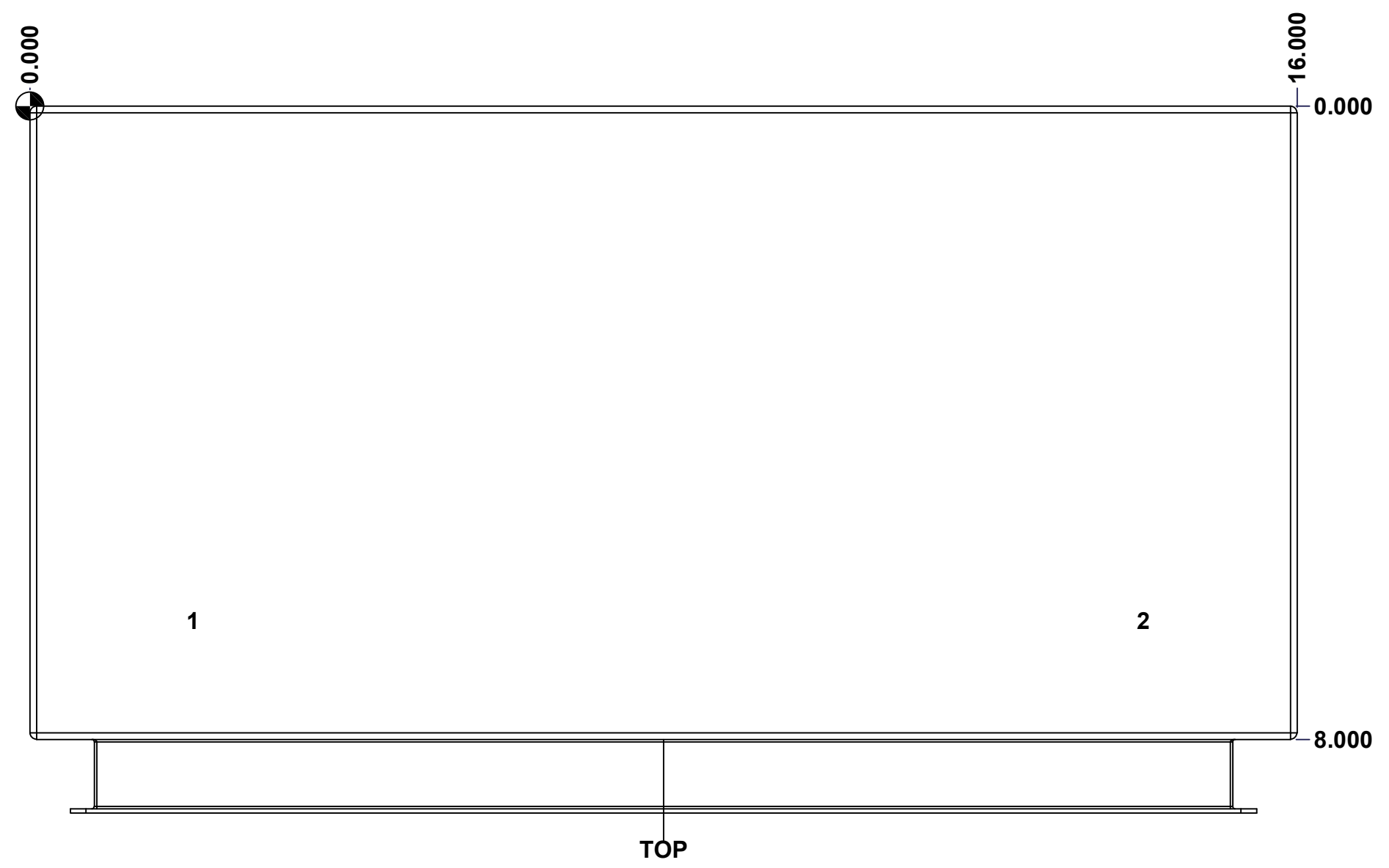

	Description		Status
	5412ESBU 30" x 16" x 8" Body		(NULL)
Part Number Numéro Pièce		Rev.	4
<b>5412ESBU301608THB</b>		<b>0</b>	16

This drawing is confidential and must not be reproduced or used without the consent of EXM

Ce dessin est confidentiel et ne doit pas être reproduit ou utilisé sans le consentement de EXM

<b>STANDARD FEATURES ARE NOT LISTED IN THIS HOLE TABLE</b>			
<b>HOLE TABLE - BOTTOM VIEW (CUSTOM FEATURE ONLY)</b>			
CUT-OUT	XDIM	YDIM	DESCRIPTION
1	2.000	6.500	INSUL. STUD M6 x 18mm (Inside)
2	14.000	6.500	INSUL. STUD M6 x 18mm (Inside)

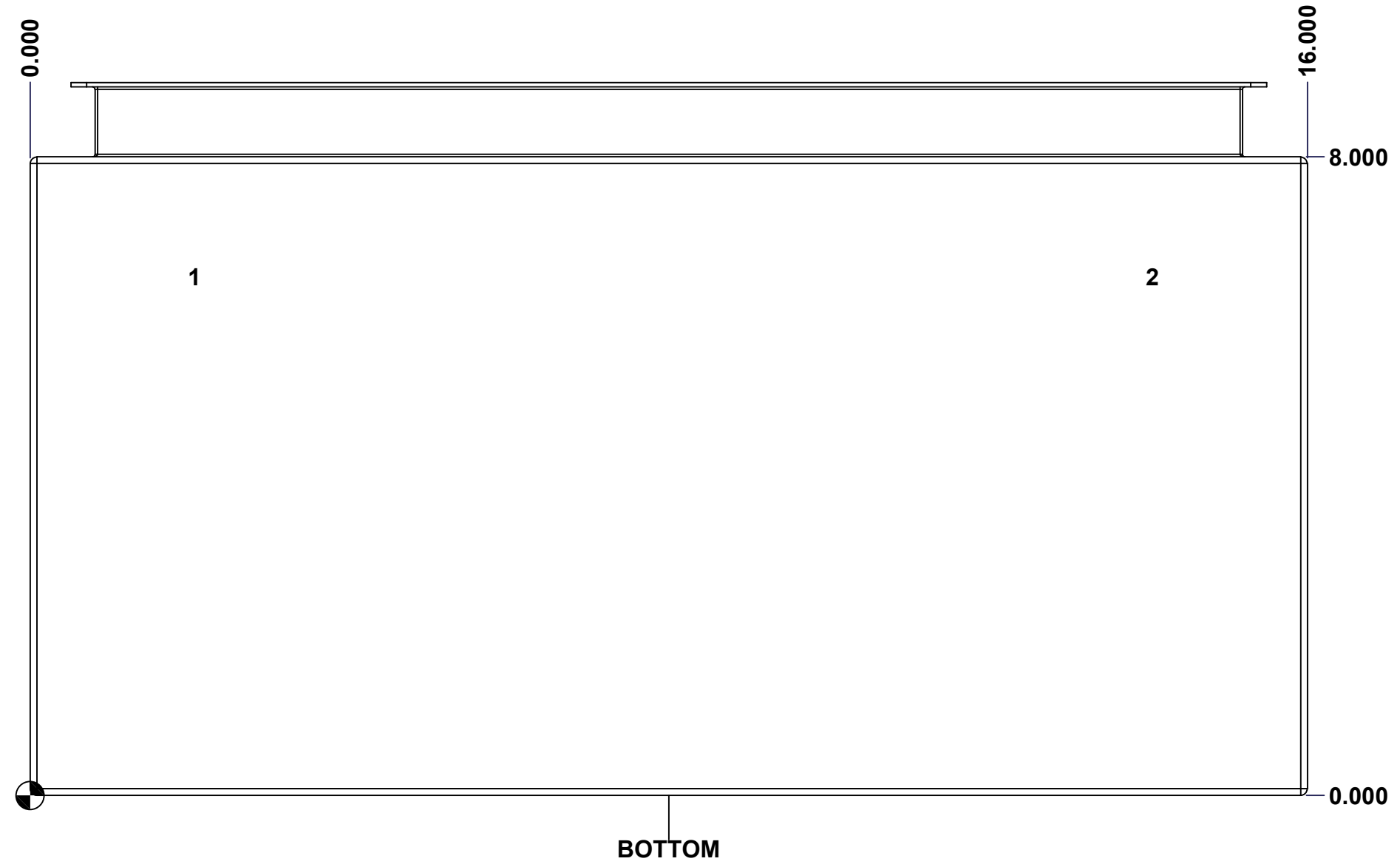

	Description	Status	
	5412ESBU 30" x 16" x 8" Body	(NULL)	
	Part Number Numéro Pièce	Rev.	
	<b>5412ESBU301608THB</b>	<b>0</b>	5 16

This drawing is confidential and must not be reproduced or used without the consent of EXM

Ce dessin est confidentiel et ne doit pas être reproduit ou utilisé sans le consentement de EXM

**STANDARD FEATURES ARE NOT LISTED IN THIS HOLE TABLE**

**HOLE TABLE - BACK VIEW (CUSTOM FEATURE ONLY)**

CUT-OUT	XDIM	YDIM	DESCRIPTION
1	1.875	1.875	IP STUD M8 x 35mm (Inside)
2	1.875	28.125	IP STUD M8 x 35mm (Inside)
3	14.125	28.125	IP STUD M8 x 35mm (Inside)
4	14.125	1.875	IP STUD M8 x 35mm (Inside)
-----			
5	15.250	0.000	FOOT 885 ESMF3_OPEN
6	0.750	0.000	FOOT 885 ESMF3_OPEN
7	15.250	30.000	FOOT 885 ESMF3_CLOSE
8	0.750	30.000	FOOT 885 ESMF3_CLOSE

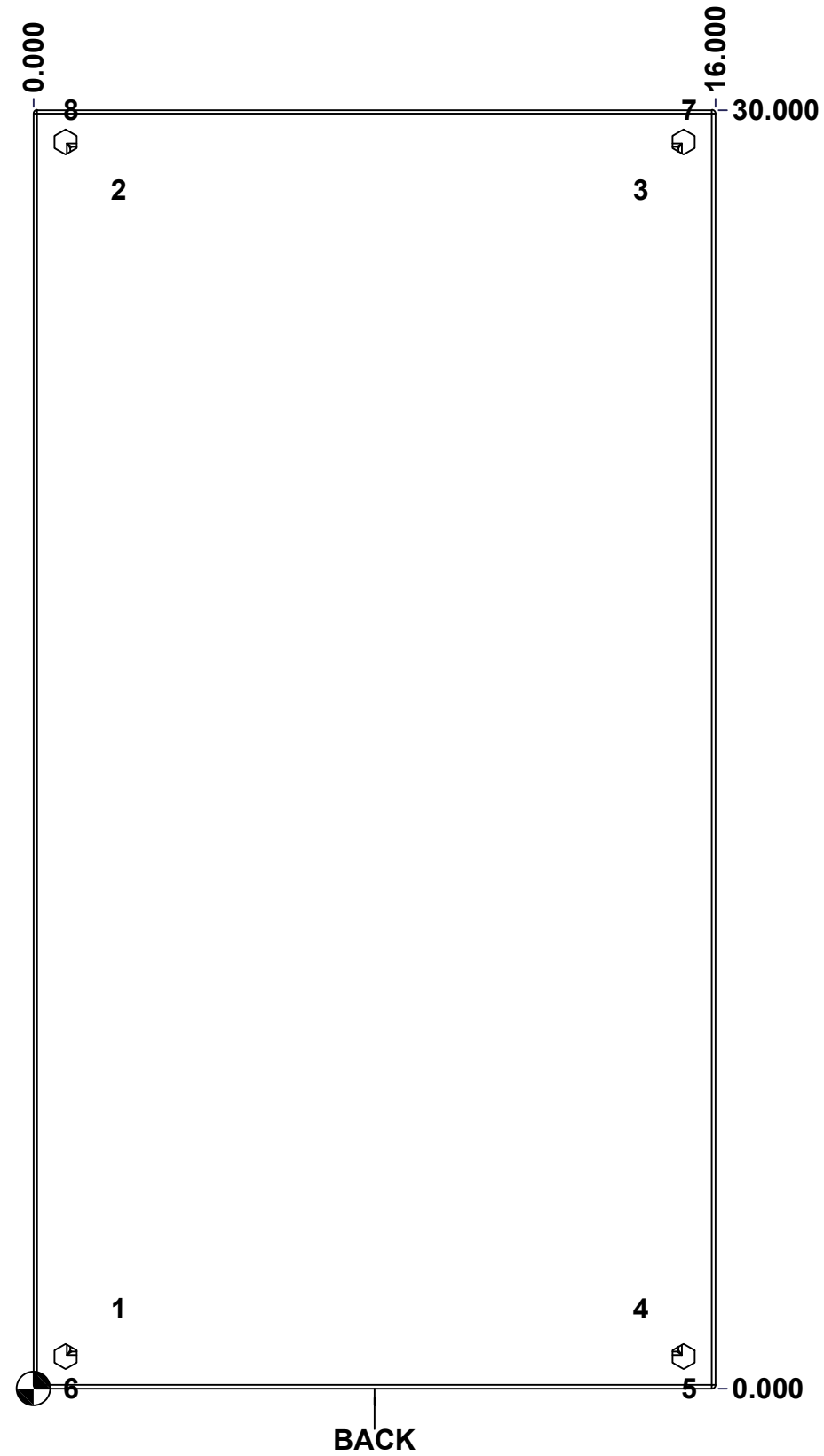

	Description	Status
	5412ESBU 30" x 16" x 8" Body	(NULL)
	Part Number Numéro Pièce	Rev.
	<b>5412ESBU301608THB</b>	<b>0</b> / 6
		16

This drawing is confidential and must not be reproduced or used without the consent of EXM

Ce dessin est confidentiel et ne doit pas être reproduit ou utilisé sans le consentement de EXM

No.	Revisions	Date	By/Par

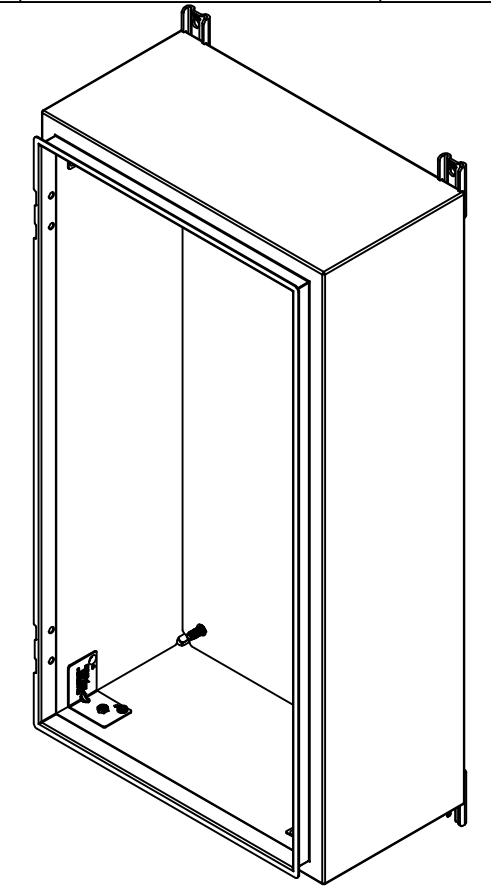

Isometric View



2	885ESMF3-FEET	0	885 ESMF3 Mounting Foot
4	RIVET_NUT_M10_FH_CE	0	Rivet Nut M10 (Low Profile Close End)
4	STK-Q-06660	2	M10 x 16mm Machine Screw
2	885ESMF3-FEET-A	0	885 ESMF3 Mounting Foot (Opened Slot)
1	STK-K-70554	3	5412 ESTH Accessory Kit
1	5412ESBU301608THI-RS	0	5412ESBU 30" x 16" Right Insulation
1	5412ESBU301608THI-LS	0	5412ESBU 30" x 16" Left Insulation
1	5412ESBU301608THI-BT	0	5412ESBU 30" x 16" Top and Bottom Insulation
1	5412ESBU301608THI-TP	0	5412ESBU 30" x 16" Top and Bottom Insulation
1	5412ESBU301608THI-B	0	5412ESBU 30" x 16" Back Insulation
4	STK-Q-16055	1	M6 x 18mm Stud (No Paint Cap Required)
1	STK-P-02400S	0	Powder Paint (Asa-61 Grey / Smooth)
4	STK-Q-16005	1	Stud M8 x 35 (No Paint Cap Required)
1	5412ESBU301608THB-P	0	5412ESBU 30" x 16" x 8" Body Part

Qty	Part Number	Rev	Description
Parts List			

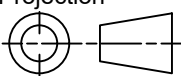
 Tél: (450) 979-4373 Fax: (450) 979-4626 <a href="http://www.exmweb.com">www.exmweb.com</a>	Flatness Aplatissement	Max 3.0mm
	Projection	
Customer Client	Date	
Drawn By Dessiné Par	BoxCad: BoxCad	Date 11-Apr-23
Material Matière	16 Ga Cold Rolled A1008 CS Type B (1.4mm)	
Color Couleur	Asa-61 Grey	Finish Fini Smooth
Description	Detail Rev.	
5412ESBU 30" x 16" x 8" Body		
Part Number Numéro Pièce	Rev. 0	7 / 16
<b>5412ESBU301608THB</b>		

This drawing is confidential and must not be reproduced or used without the consent of EXM

Ce dessin est confidentiel et ne doit pas être reproduit ou utilisé sans le consentement de EXM



TOP

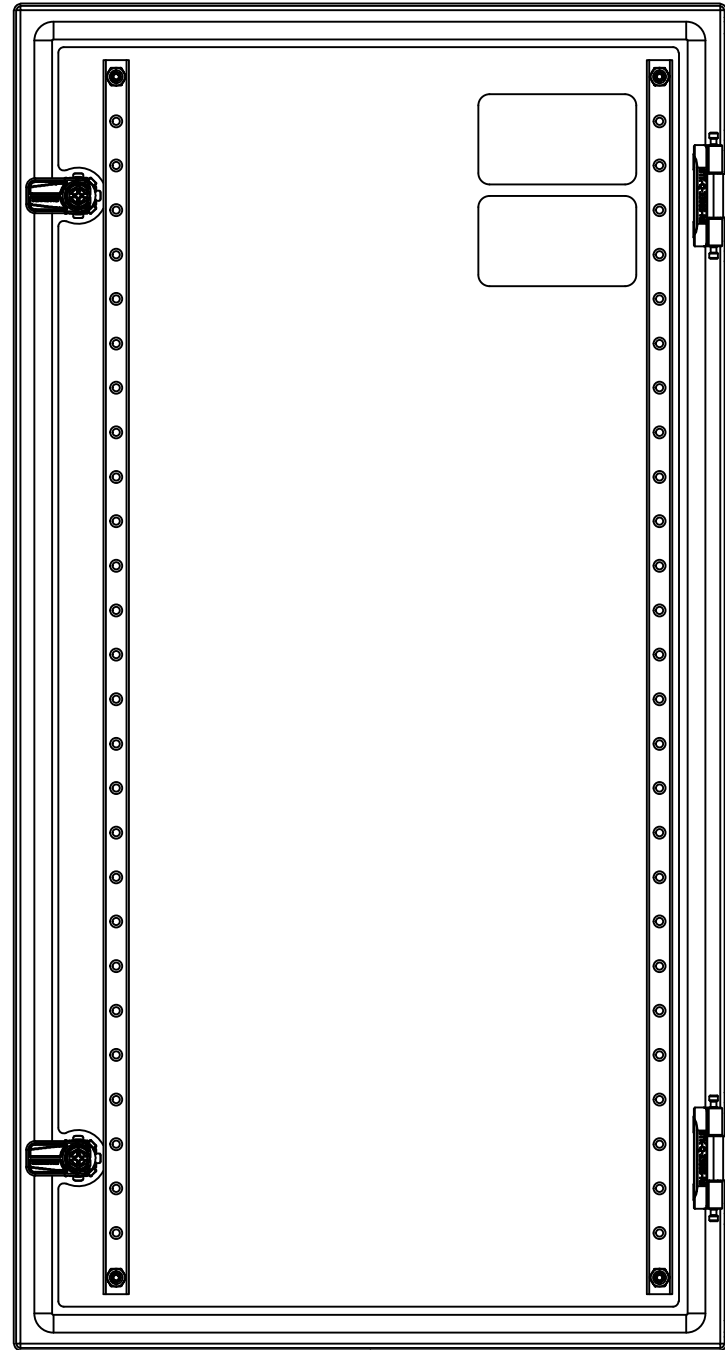

BACK

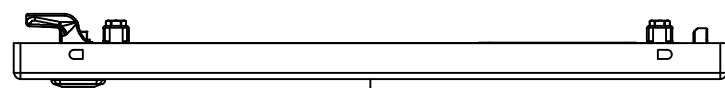

BOTTOM

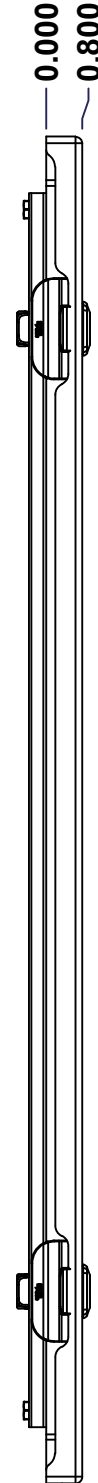

LEFT

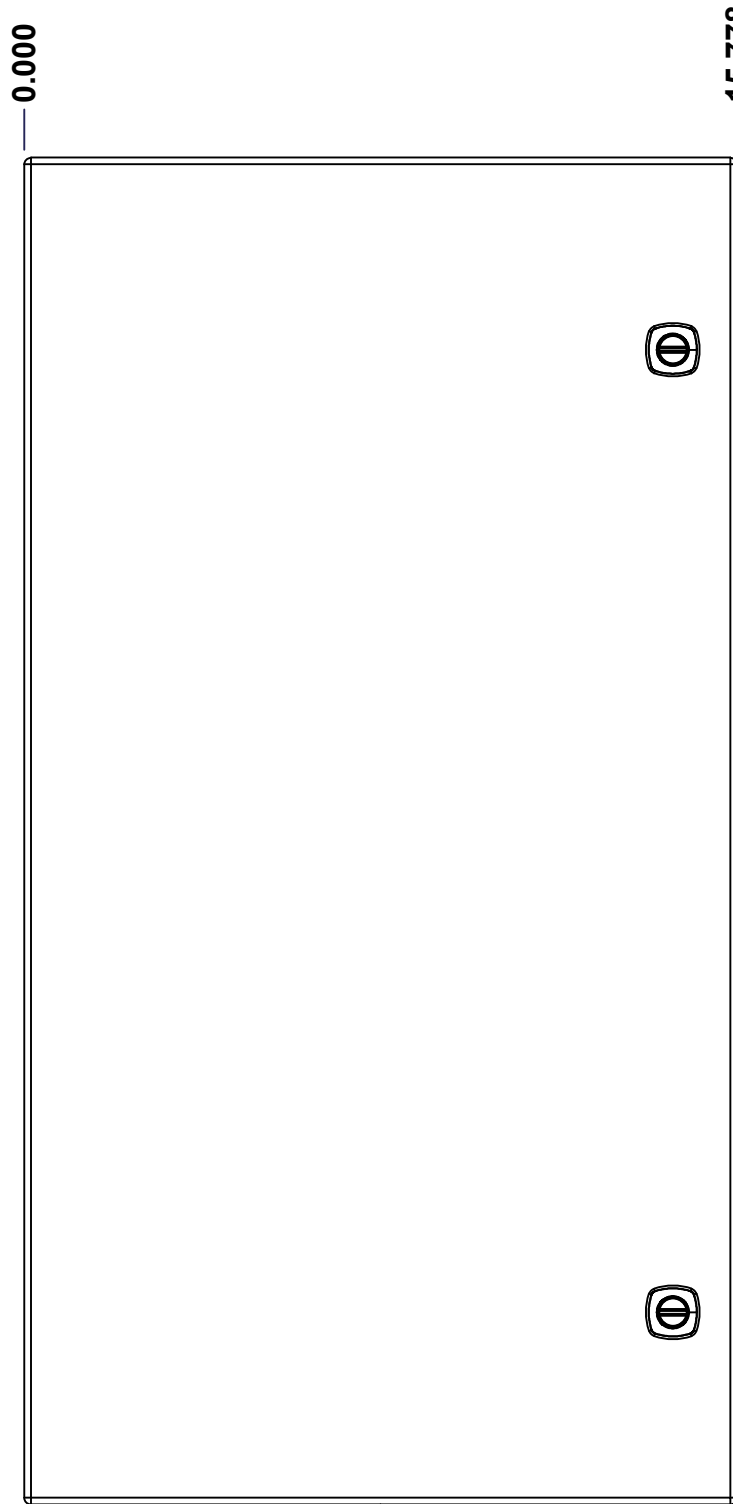

FRONT

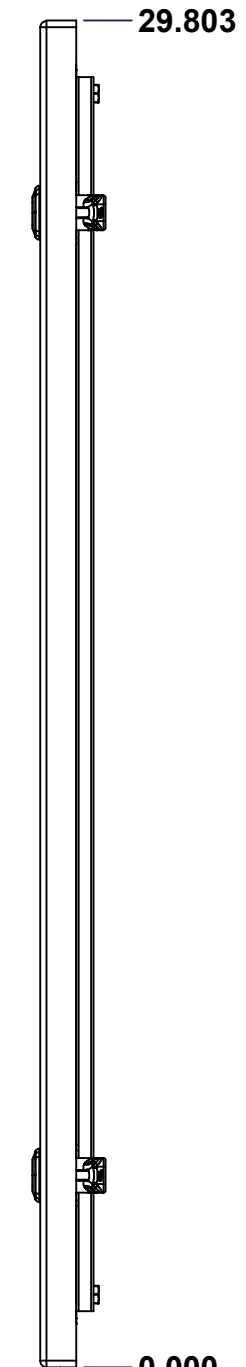

RIGHT

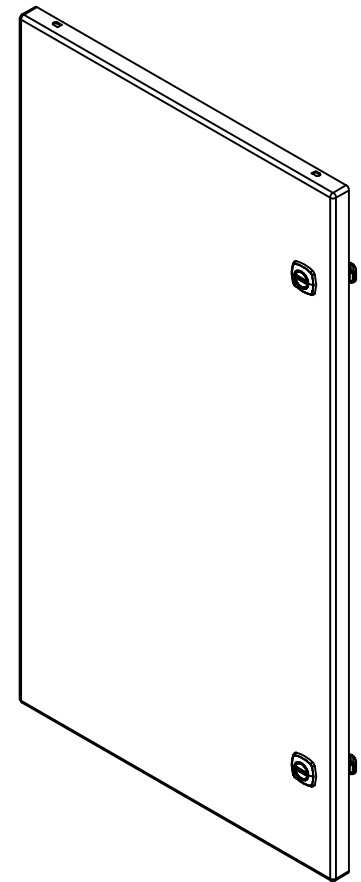

Isometric View

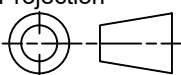

No.	Revisions	Date	By/Par

 Tél: (450) 979-4373 Fax: (450) 979-4626 <a href="http://www.exmweb.com">www.exmweb.com</a>		Flatness Aplatissement Max 3.0mm Projection 
Customer Client	Date	
Drawn By Dessiné Par	BoxCad: BoxCad	Date 11-Apr-23
Material Matière	16 Ga Cold Rolled A1008 CS Type B (1.4mm)	
Color Couleur	Asa-61 Grey	Finish Fini Smooth
Description 5412ESBU 30" x 16" Cover		Detail Rev.
Part Number Numéro Pièce	Rev. 0	8 / 16

SEE BILL OF MATERIAL ON LAST PAGE

**5412ESBU301608THC**



This drawing is confidential and must not be reproduced or used without the consent of EXM

Ce dessin est confidentiel et ne doit pas être reproduit ou utilisé sans le consentement de EXM

STANDARD FEATURES ARE NOT LISTED IN THIS HOLE TABLE			
HOLE TABLE - FRONT VIEW (CUSTOM FEATURE ONLY)			
CUT-OUT	XDIM	YDIM	DESCRIPTION
1	1.486	1.614	STUD M6 x 18mm (Inside)
2	1.486	28.189	STUD M6 x 18mm (Inside)
3	13.517	28.189	STUD M6 x 18mm (Inside)
4	13.517	1.614	STUD M6 x 18mm (Inside)
-----			
5	14.354	25.553	880 SCQ4-SL
6	14.354	4.250	880 SCQ4-SL

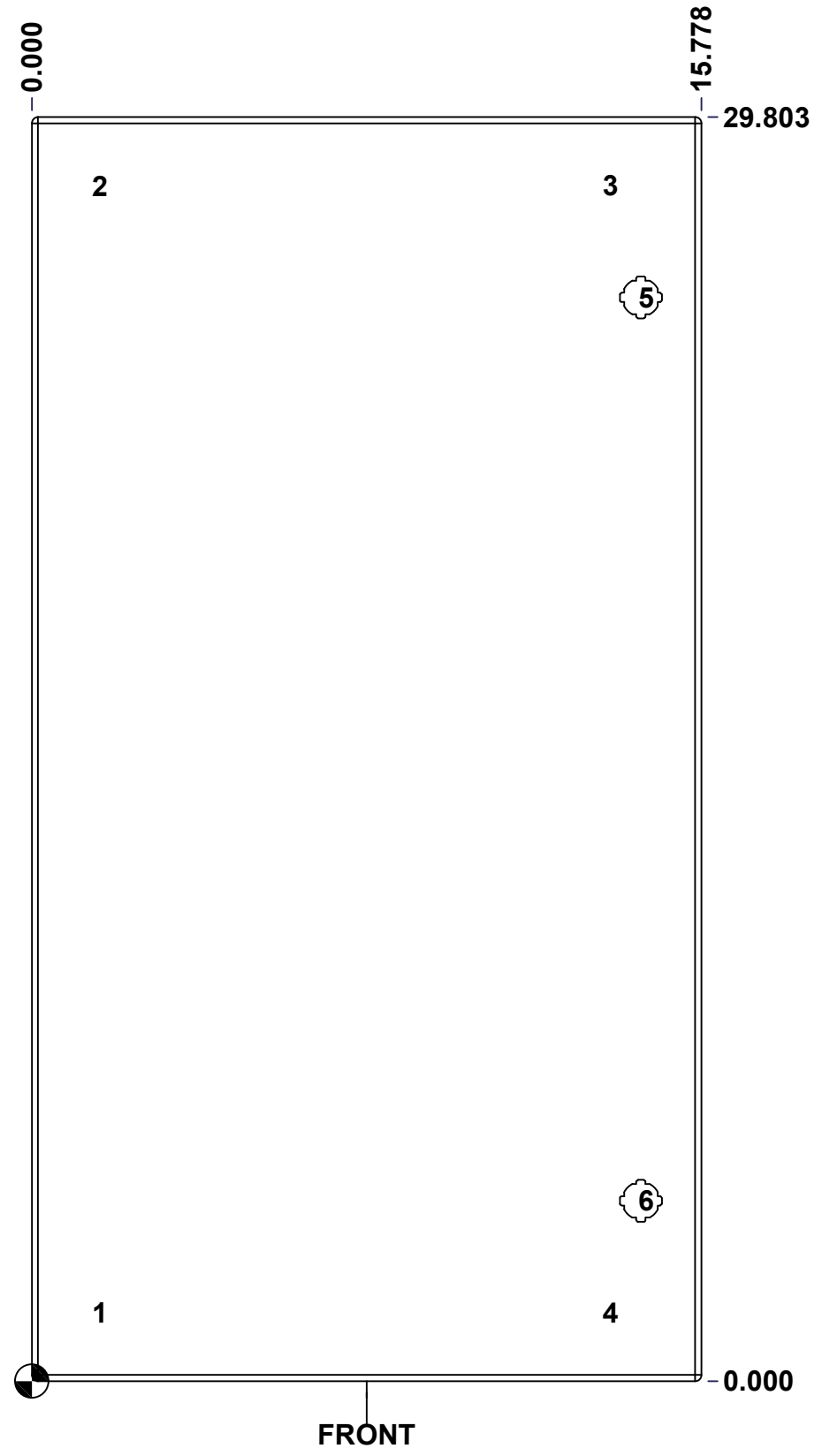

	Description	Status
	5412ESBU 30" x 16" Cover	(NULL)
	Part Number Numéro Pièce	Rev.
	<b>5412ESBU301608THC</b>	<b>0</b> / 9
		16

This drawing is confidential and must not be reproduced or used without the consent of EXM

Ce dessin est confidentiel et ne doit pas être reproduit ou utilisé sans le consentement de EXM

No.	Revisions	Date	By/Par

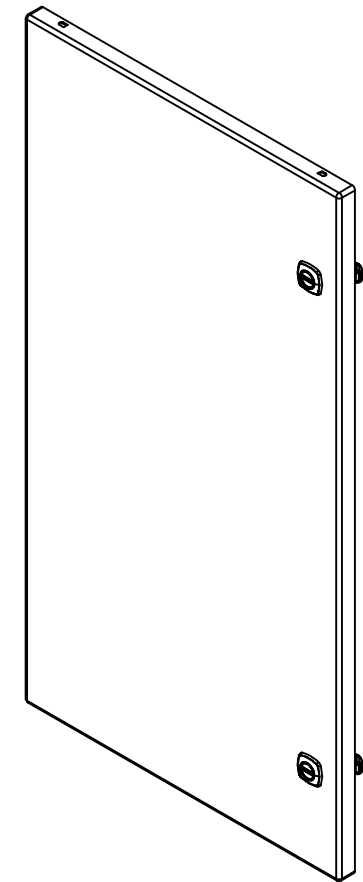

Isometric View



 Tél: (450) 979-4373  
 Fax: (450) 979-4626  
[www.exmweb.com](http://www.exmweb.com)

Flatness  
 Aplatissement  
 Max 3.0mm  
 Projection  



2	STK-S-00100	0	3.5" x 2" Silver Milar Flexcon Sticker
4	STK-Q-07250	2	M6 x 16mm Collar Nut
2	STK-Q-46020-30	5	5412 ES Vertical Door Stiffener 30"
1	5412ESBU301608THI-C	0	5412ESBU 30" x 16" Cover Insulation
1	STK-P-02400S	0	Powder Paint (Asa-61 Grey / Smooth)
4	STK-Q-16055	1	M6 x 18mm Stud (No Paint Cap Required)
2	STK-A-33005	4	5412 ESBU Hinge 180° (Body Part)
1	5412ESBU301608THG	0	5412ESBU 30" x 16" Cover Gasket Part
1	5412ESBU301608THC-P	0	5412ESBU 30" x 16" Cover Part
2	STK-K-12500	16	5412 ES 1/4 Turn Lock

Customer Client	Date
Drawn By Dessiné Par	Date 11-Apr-23
Material Matière	16 Ga Cold Rolled A1008 CS Type B (1.4mm)
Color Couleur	Asa-61 Grey
Finish Fini	Smooth
Description	Detail Rev.
5412ESBU 30" x 16" Cover	
Part Number Numéro Pièce	Rev. 10
<b>5412ESBU301608THC</b>	<b>0</b> 16

QTY	Part Number	Rev	Description
Parts List			

This drawing is confidential and must not be reproduced or used without the consent of EXM

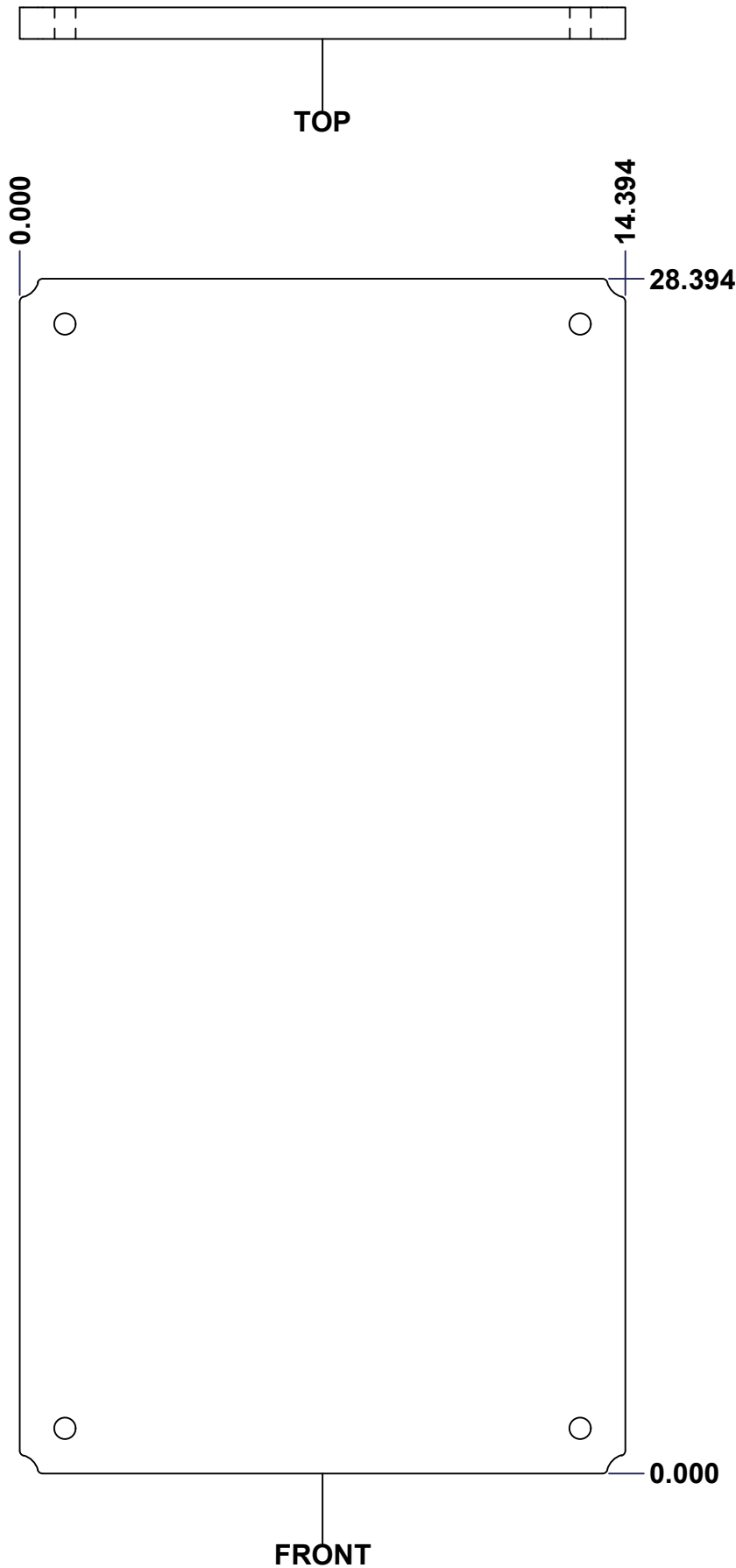
Ce dessin est confidentiel et ne doit pas être reproduit ou utilisé sans le consentement de EXM



No.	Revisions	Date	By/Par

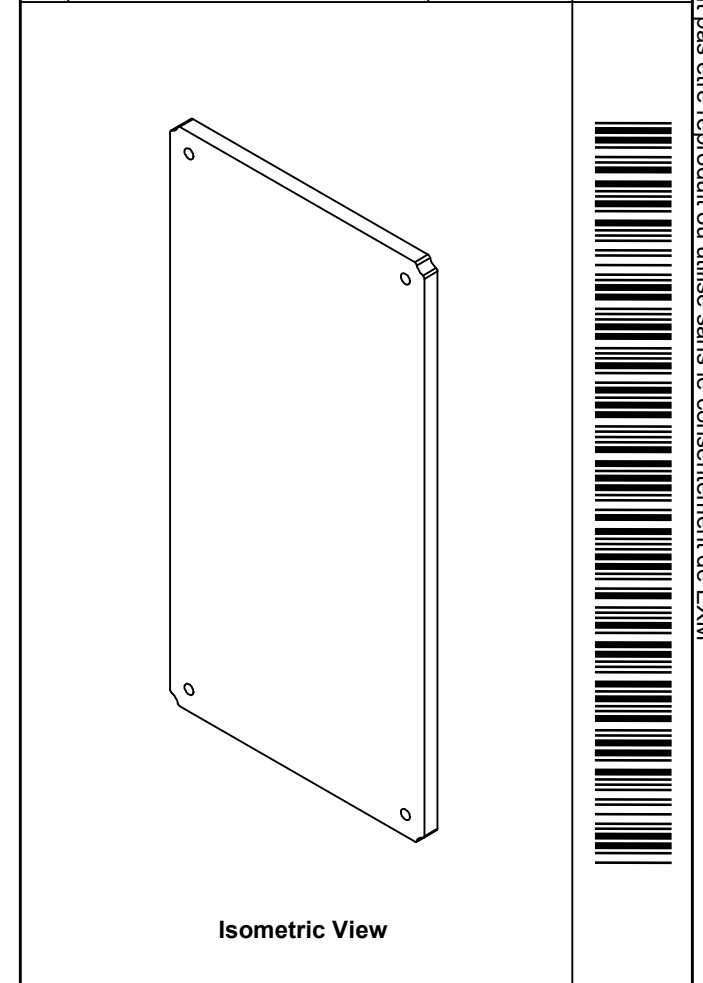

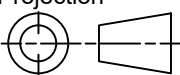
 Tél: (450) 979-4373 Fax: (450) 979-4626 <a href="http://www.exmweb.com">www.exmweb.com</a>		Flatness Aplatissement Max 3.0mm Projection 
Customer Client	Date	
Drawn By Dessiné Par	BoxCad: Patrick Deschenes	Date 23-Jan-07
Material Matière	Polyisocyanurate	
Color Couleur	Aluminum	Finish Fini N/A
Description		Detail Rev.
5412ESBU 30" x 16" Back Insulation		
Part Number Numéro Pièce	Rev.	11
5412ESBU301608THI-B	0	16

SEE BILL OF MATERIAL ON LAST PAGE

This drawing is confidential and must not be reproduced or used without the consent of EXM

Ce dessin est confidentiel et ne doit pas être reproduit ou utilisé sans le consentement de EXM

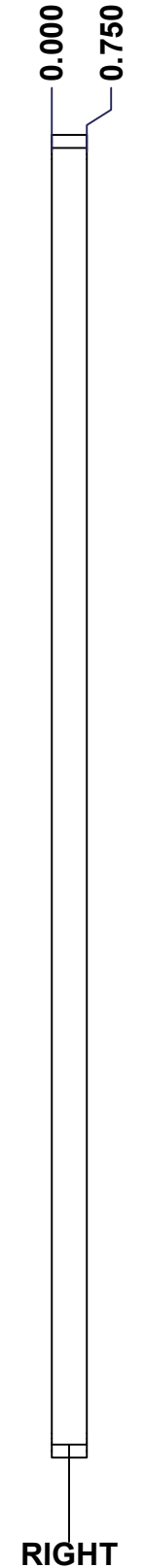
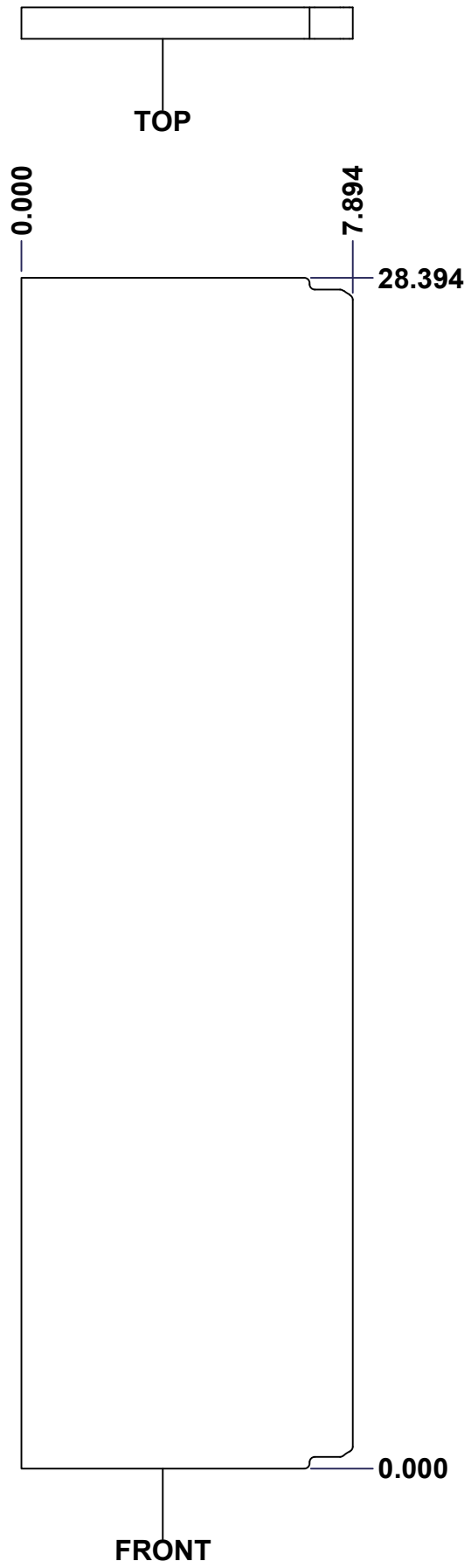

No.	Revisions	Date	By/Par

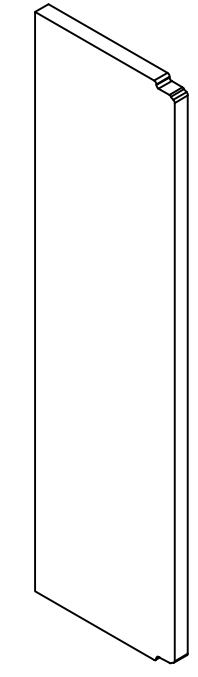

**Isometric View**

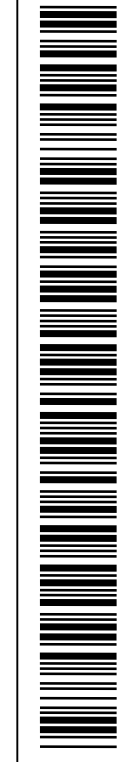

 Tél: (450) 979-4373 Fax: (450) 979-4626 <a href="http://www.exmweb.com">www.exmweb.com</a>		Flatness Aplatissement	
		Max 3.0mm	
Customer Client		Date	
Drawn By Dessiné Par		Date	
Material Matière		Polyisocyanurate	
Color Couleur		Aluminum	Finish Fini
Description		Detail Rev.	
5412ESBU 30" x 16" Left Insulation			
Part Number Numéro Pièce		Rev.	
5412ESBU301608THI-LS		0	12 16

**SEE BILL OF MATERIAL ON LAST PAGE**

This drawing is confidential and must not be reproduced or used without the consent of EXM

Ce dessin est confidentiel et ne doit pas être reproduit ou utilisé sans le consentement de EXM

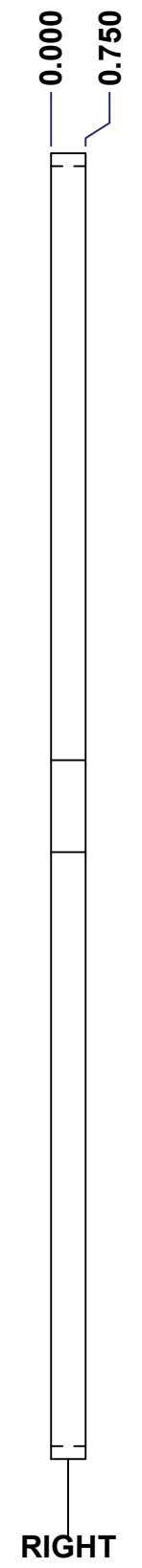
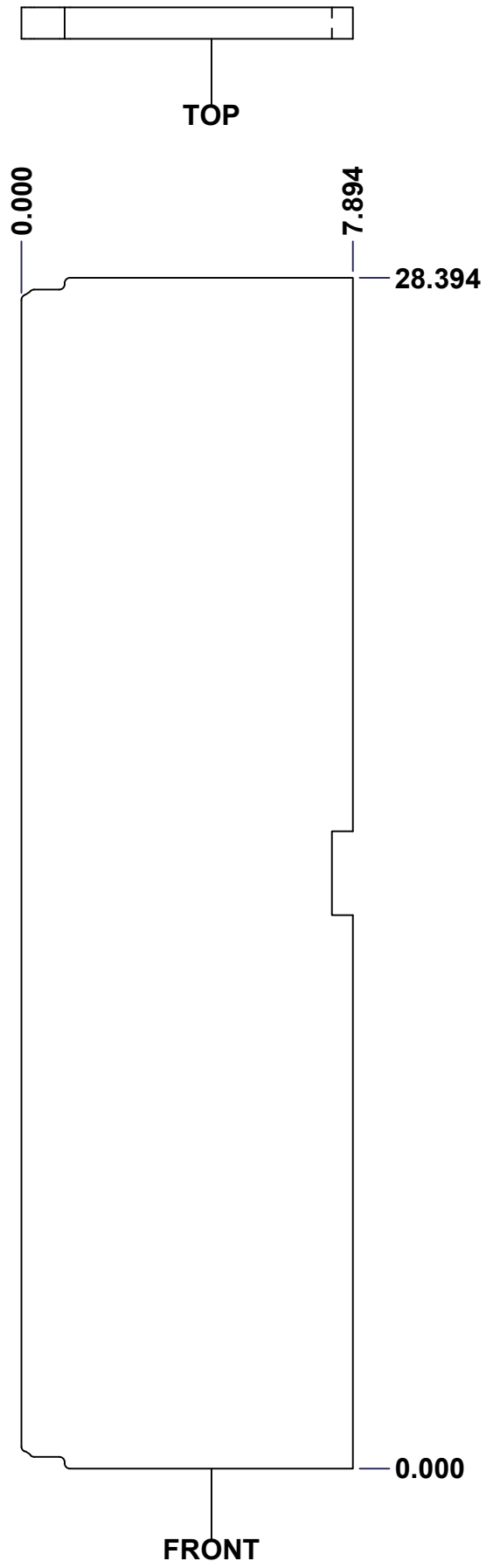

No.	Revisions	Date	By/Par

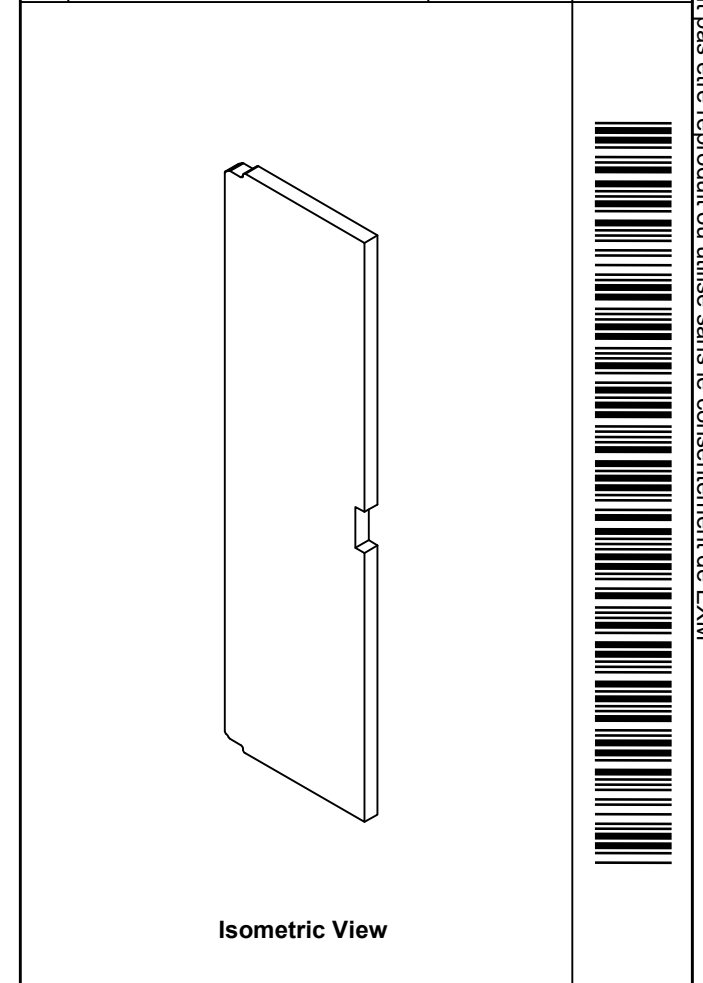

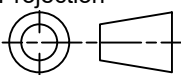
 Tél: (450) 979-4373 Fax: (450) 979-4626 <a href="http://www.exmweb.com">www.exmweb.com</a>		Flatness Aplatissement Max 3.0mm
Projection 		Date 23-Jan-07
Customer Client	Date	
Drawn By / Dessiné Par: BoxCad: Patrick Deschenes	Date: 23-Jan-07	
Material / Matière: Polyisocyanurate		
Color / Couleur: Aluminum	Finish / Fini: N/A	
Description: 5412ESBU 30" x 16" Right Insulation	Detail Rev.	
Part Number / Numéro Pièce: 5412ESBU301608THI-RS	Rev. 0	13 / 16

SEE BILL OF MATERIAL ON LAST PAGE

This drawing is confidential and must not be reproduced or used without the consent of EXM

Ce dessin est confidentiel et ne doit pas être reproduit ou utilisé sans le consentement de EXM

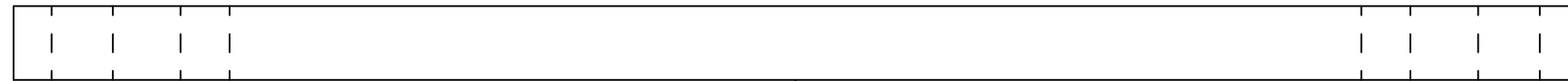

TOP

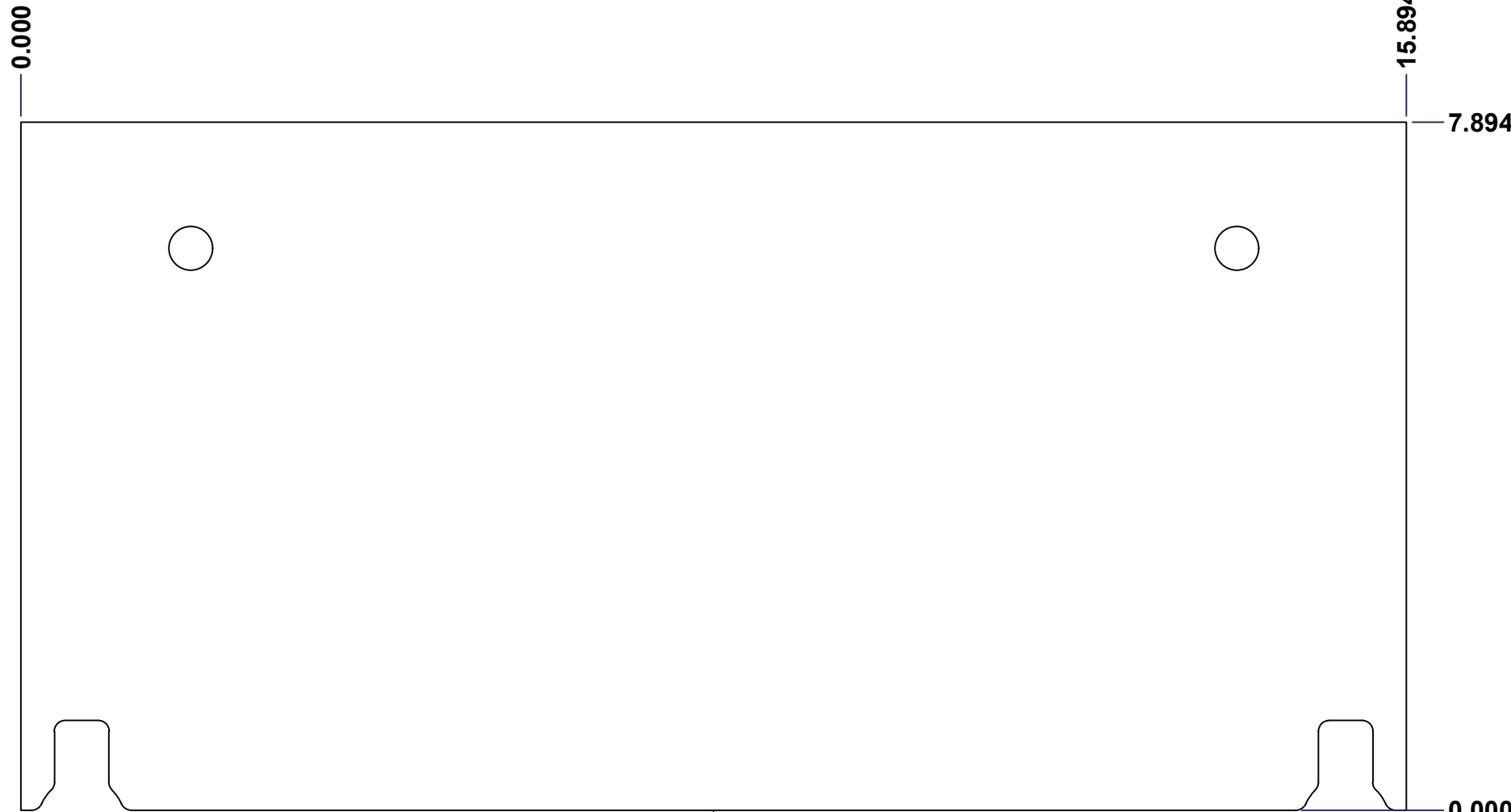

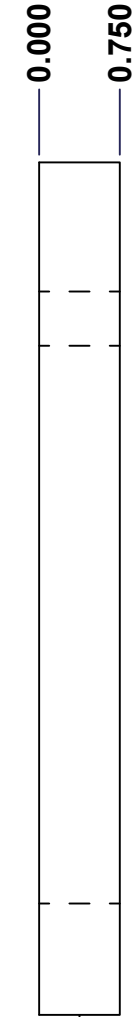

FRONT

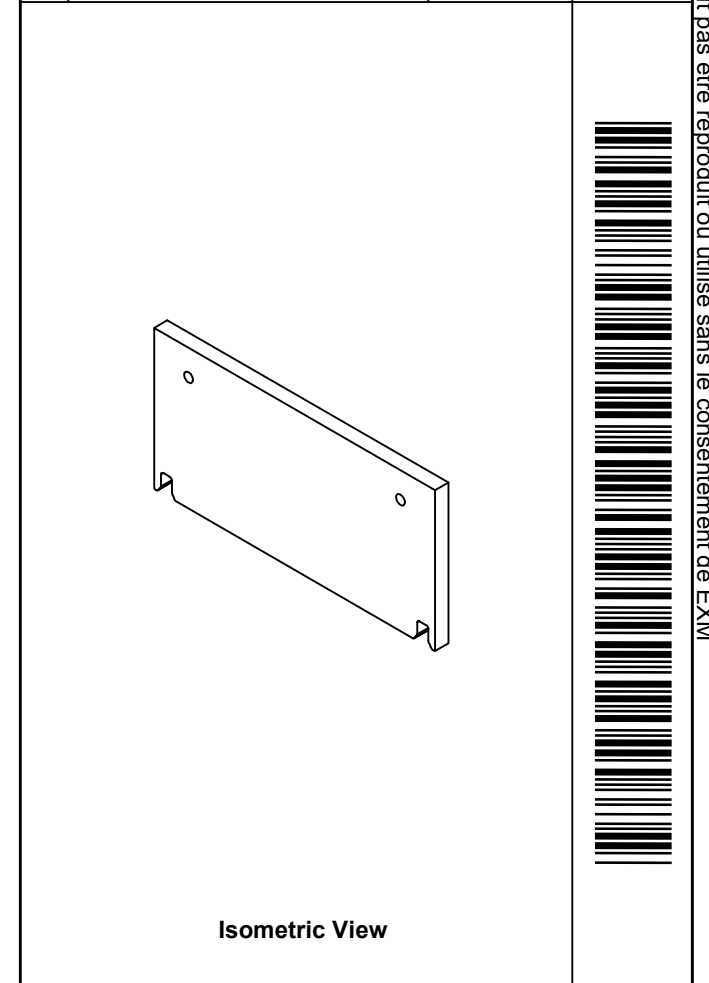

RIGHT

No.	Revisions	Date	By/Par

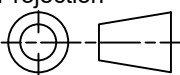

 Tél: (450) 979-4373 Fax: (450) 979-4626 <a href="http://www.exmweb.com">www.exmweb.com</a>		Flatness Aplatissement
		Max 3.0mm
Customer Client		Projection 
Drawn By / Dessiné Par: BoxCad: Patrick Deschenes		Date: 23-Jan-07
Material / Matière: Polyisocyanurate		
Color / Couleur: Aluminum	Finish / Fini: N/A	
Description: 5412ESBU 30" x 16" Top and Bottom Insulation		Detail Rev.
Part Number / Numéro Pièce: 5412ESBU301608THI-TP		Rev. 14 <b>0</b>

SEE BILL OF MATERIAL ON LAST PAGE

This drawing is confidential and must not be reproduced or used without the consent of EXM

Ce dessin est confidentiel et ne doit pas être reproduit ou utilisé sans le consentement de EXM

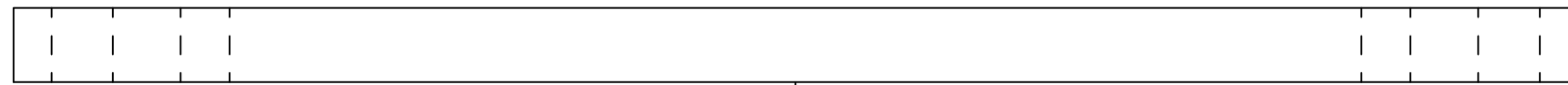

TOP

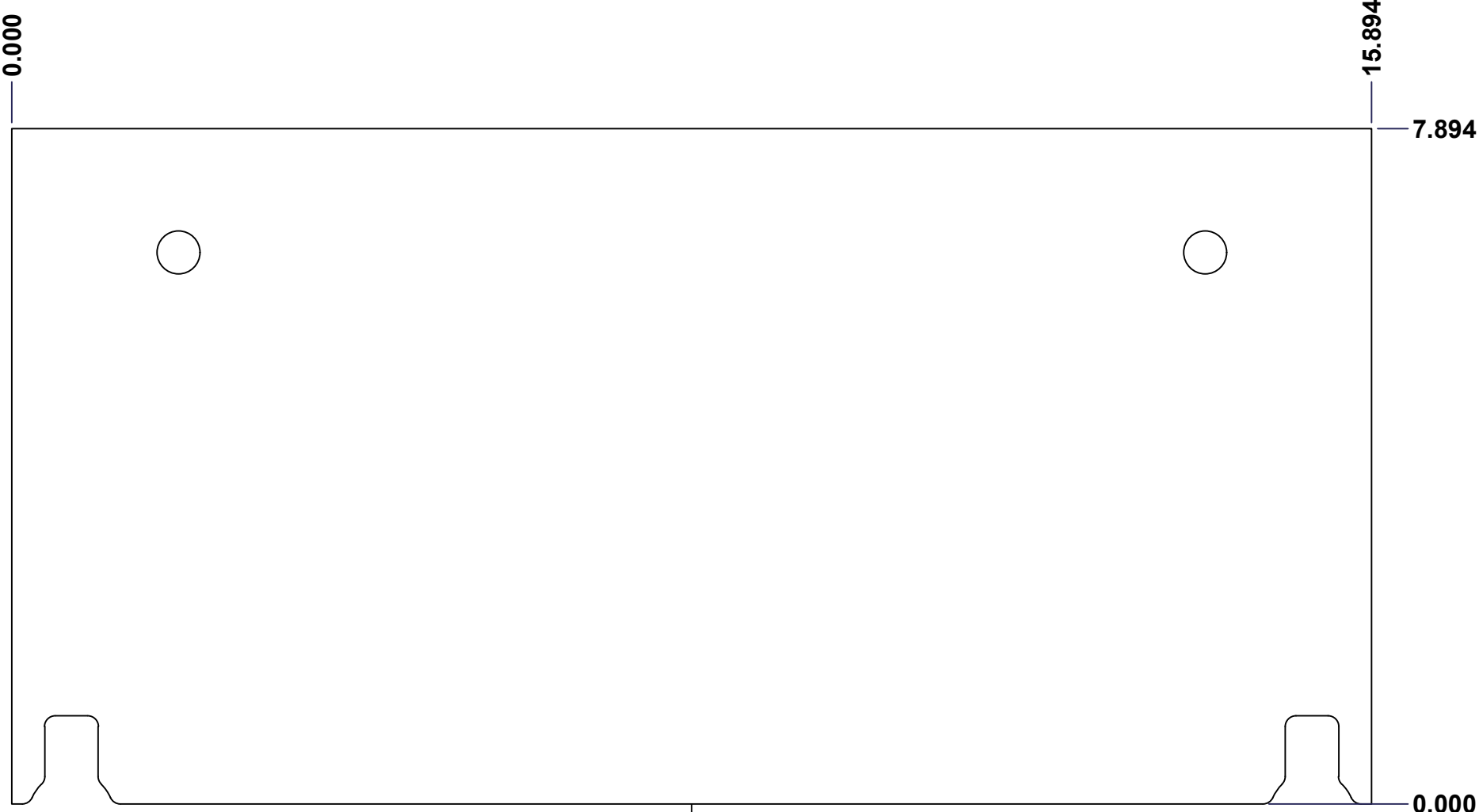

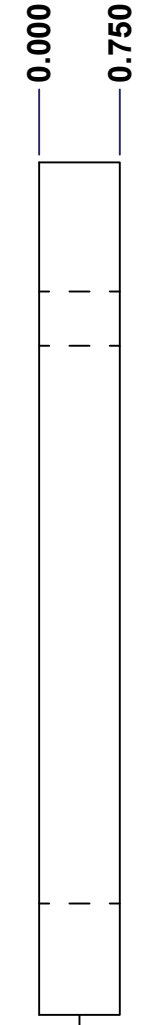

FRONT

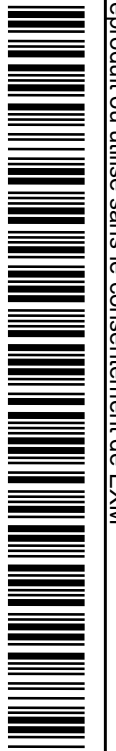
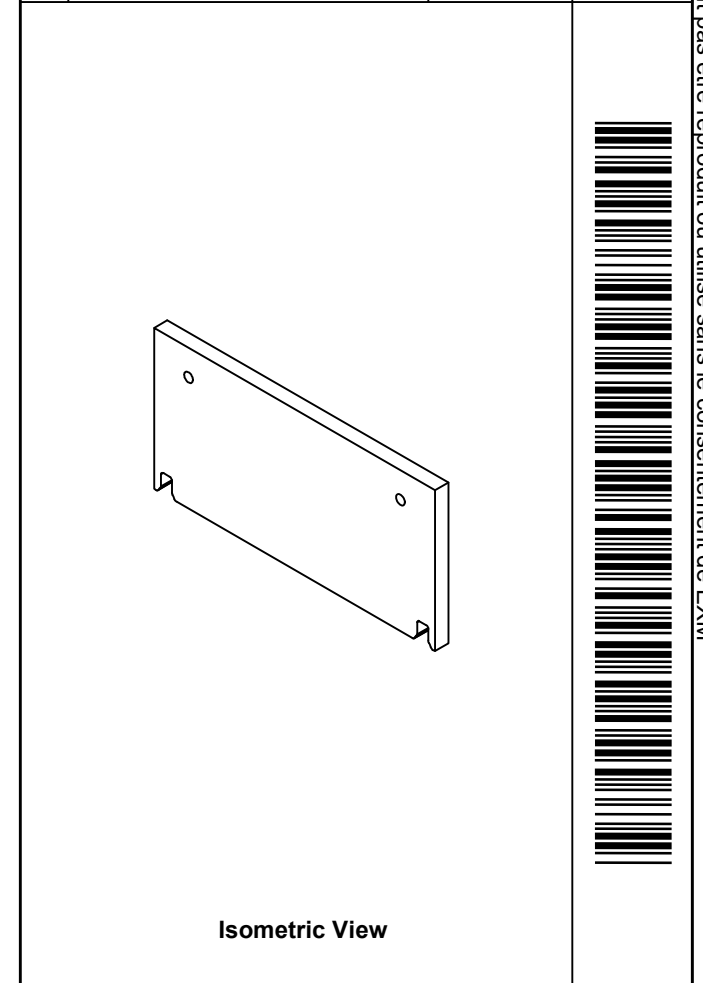

RIGHT

No.	Revisions	Date	By/Par

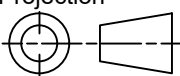

 Tél: (450) 979-4373 Fax: (450) 979-4626 <a href="http://www.exmweb.com">www.exmweb.com</a>	Flatness Aplatissement	Max 3.0mm
	Projection	
Customer Client	Date	
Drawn By Dessiné Par	BoxCad: Patrick Deschenes	Date 23-Jan-07
Material Matière	Polyisocyanurate	
Color Couleur	Aluminum	Finish Fini N/A
Description	Detail Rev.	
5412ESBU 30" x 16" Top and Bottom Insulation		
Part Number Numéro Pièce	Rev.	15
<b>5412ESBU301608THI-BT</b>	<b>0</b>	16

**SEE BILL OF MATERIAL ON LAST PAGE**

This drawing is confidential and must not be reproduced or used without the consent of EXM

Ce dessin est confidentiel et ne doit pas être reproduit ou utilisé sans le consentement de EXM

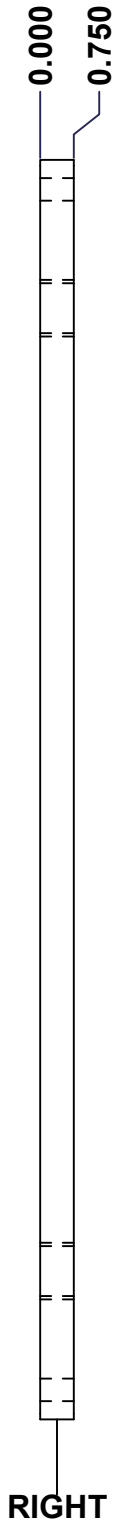
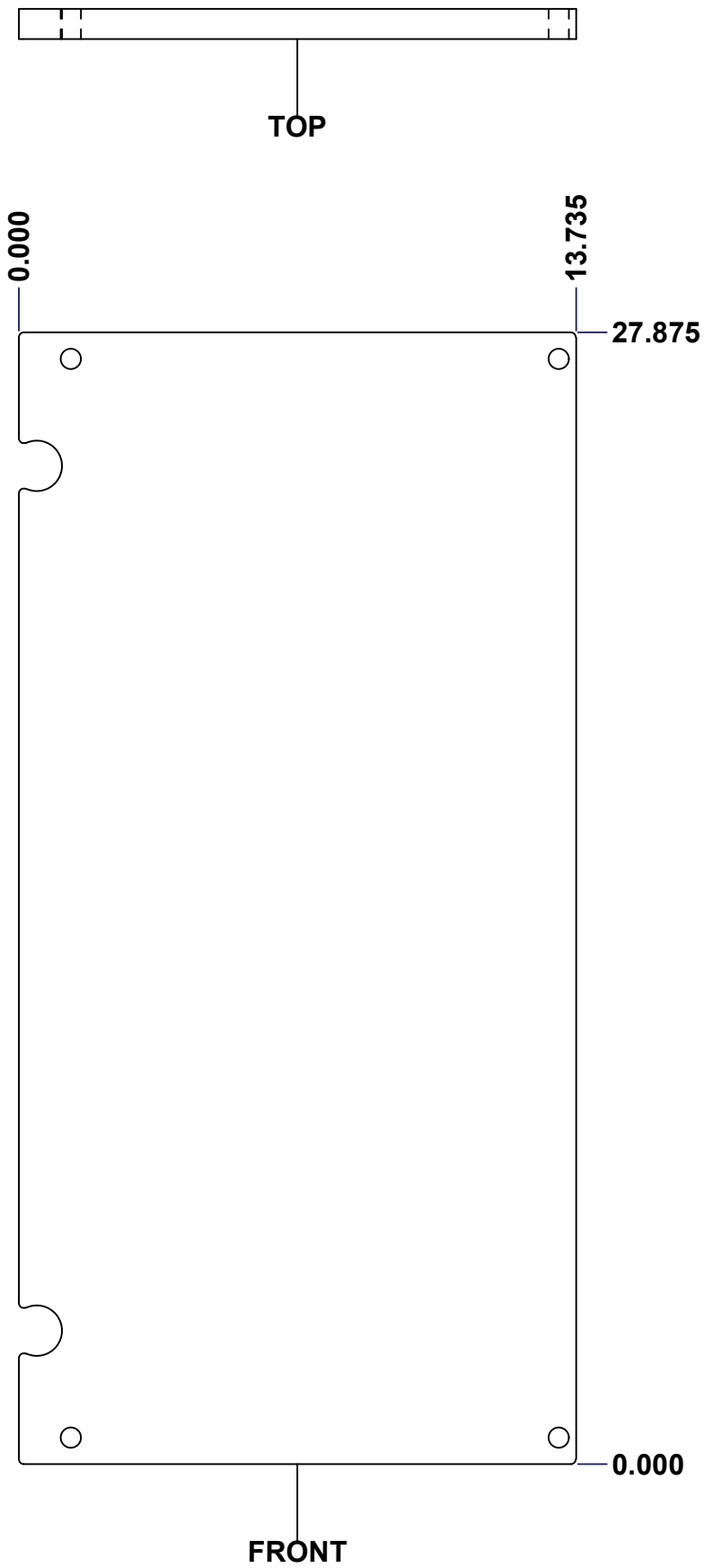

No.	Revisions	Date	By/Par

**Isometric View**

<p>Tél: (450) 979-4373 Fax: (450) 979-4626 <a href="http://www.exmweb.com">www.exmweb.com</a></p>		Flatness Aplatissement
		Max 3.0mm
Projection		Date
Customer Client	BoxCad: Patrick Deschenes	Date
Drawn By Dessiné Par	BoxCad: Patrick Deschenes	Date 23-Jan-07
Material Matière	Polyisocyanurate	
Color Couleur	Aluminum	Finish Fini N/A
Description	Detail Rev.	
5412ESBU 30" x 16" Cover Insulation		
Part Number Numéro Pièce	Rev.	16
<b>5412ESBU301608THI-C</b>	<b>0</b>	16

**SEE BILL OF MATERIAL ON LAST PAGE**



This drawing is confidential and must not be reproduced or used without the consent of EXM

Ce dessin est confidentiel et ne doit pas être reproduit ou utilisé sans le consentement de EXM

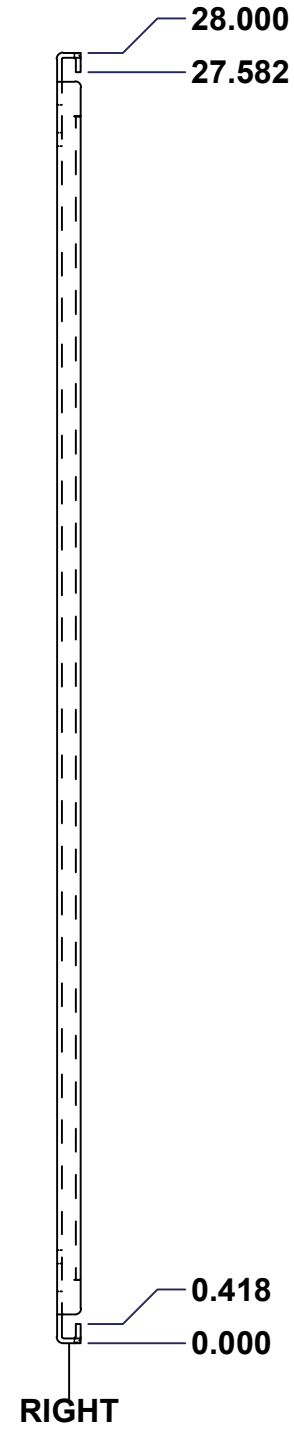
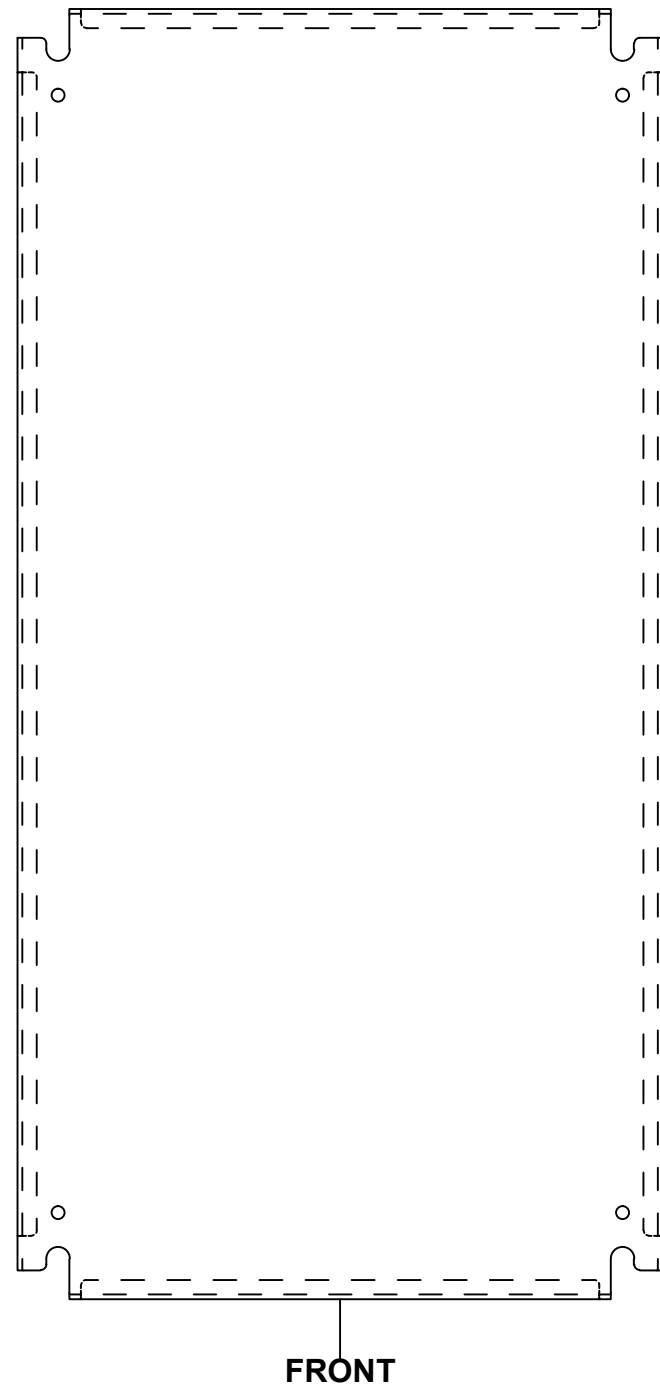
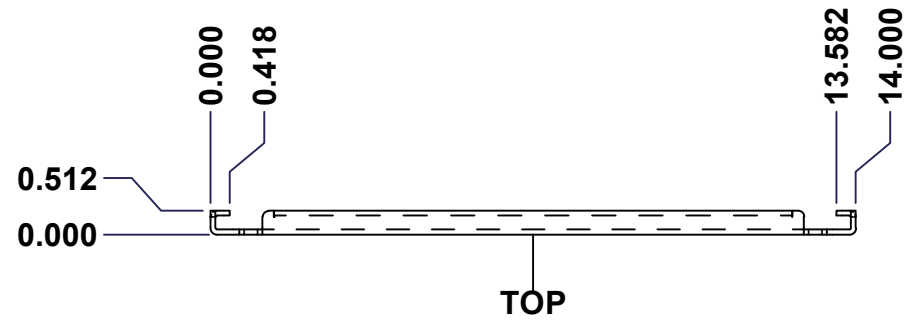

No.	Revisions	Date	By/Par

**Isometric View**

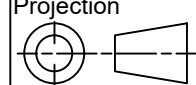

 Tél: (450) 979-4373 Fax: (450) 979-4626 www.exmweb.com	Flatness Aplatissement Max 3.0mm
	Projection 
Customer Client	Date
Drawn By Dessiné Par BoxCad	Date 23-Jan-07
Material Matière	See Part List
Color Couleur	See Part List
Finish Fini	See Part List
Description	Detail Rev.
881 SP - Inner Panel	
Part Number Numéro Pièce	Rev.
<b>881 SP3016G</b>	<b>0</b>

Qty	Part Number	Rev	Description	Material	Color	Finish
1	881 SP3016G-P	0	881 SP - Inner Panel Part	12 Ga Galvanized	Unpainted	Galvanized

Parts List

This drawing is confidential and must not be reproduced or used without the consent of EXM

Ce dessin est confidentiel et ne doit pas être reproduit ou utilisé sans le consentement de EXM

Table 1			FRONT VIEW
CUT-OUT	XDIM	YDIM	DESCRIPTION
1	0.875	1.875	GROUND HOLE (RND Ø0.290)
2	13.125	1.875	GROUND HOLE (RND Ø0.290)
3	0.875	26.125	GROUND HOLE (RND Ø0.290)
4	13.125	26.125	GROUND HOLE (RND Ø0.290)

All knockouts are actual size / Les disques défonçables sont grandeur réel

No.	Revisions	Date	By/Par

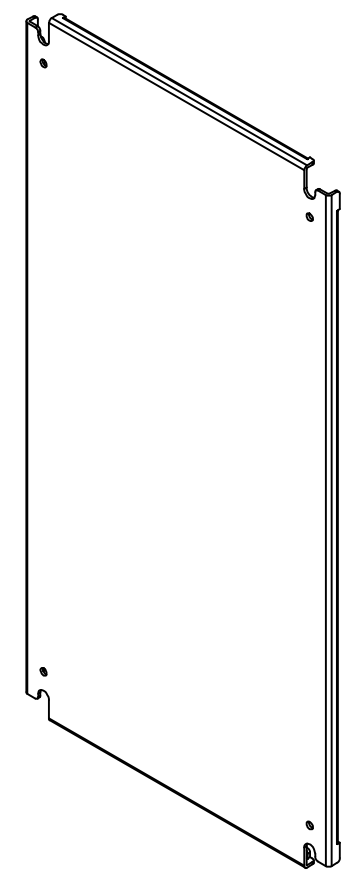
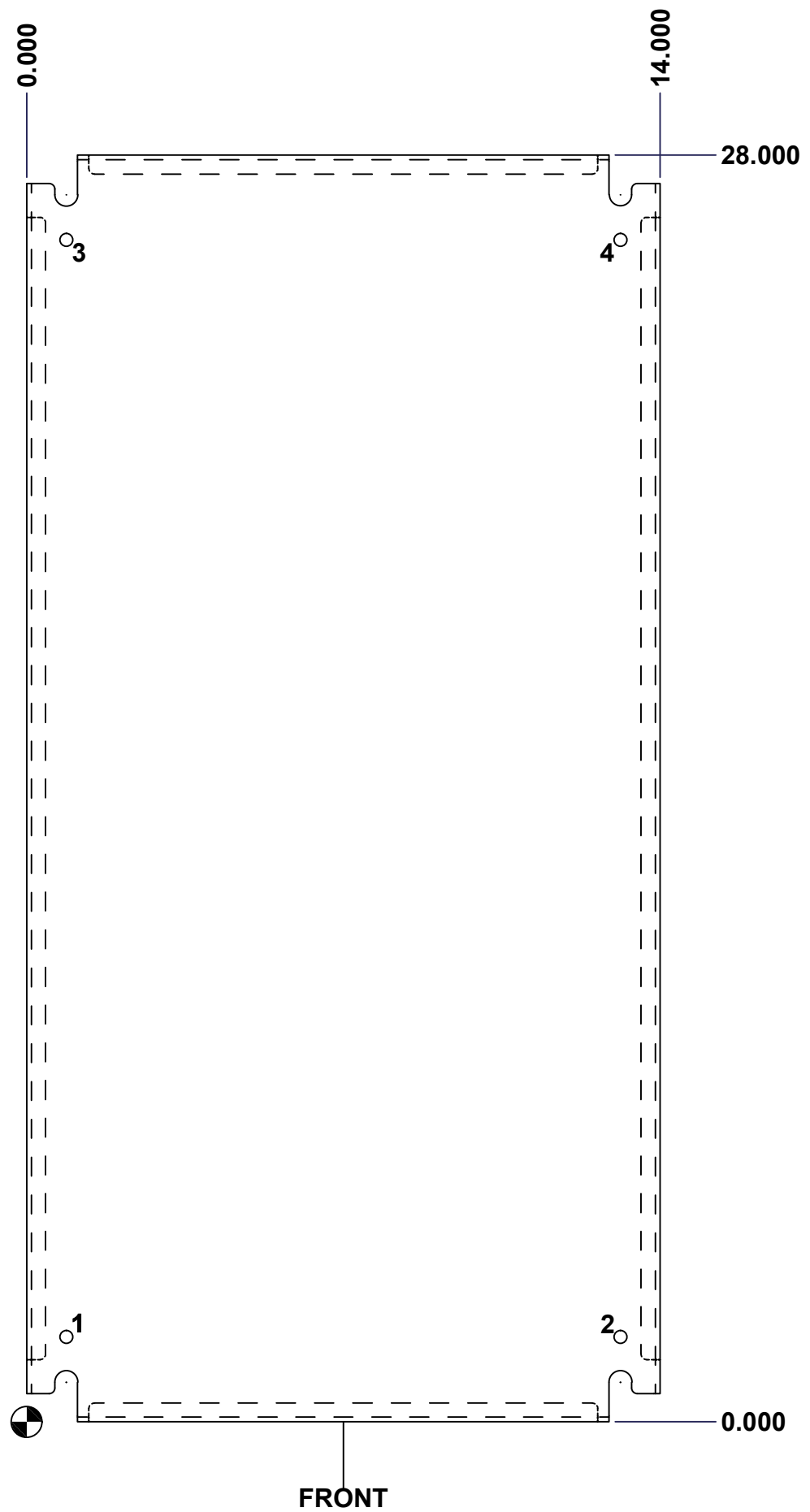

Isometric View

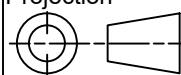

 Tél: (450) 979-4373 Fax: (450) 979-4626 www.exmweb.com	Flatness Aplatissement Max 3.0mm
	Projection 
Customer Client	Date
Drawn By Dessiné Par BoxCad	Date 23-Jan-07
Material Matière	See Part List
Color Couleur	See Part List
Finish Fini	See Part List
Description 881 SP - Inner Panel	Detail Rev.
Part Number Numéro Pièce <b>881 SP3016G</b>	Rev. 0

2  
2