

This drawing is confidential and must not be reproduced or used without the consent of EXM

Ce dessin est confidentiel et ne doit pas être reproduit ou utilisé sans le consentement de EXM

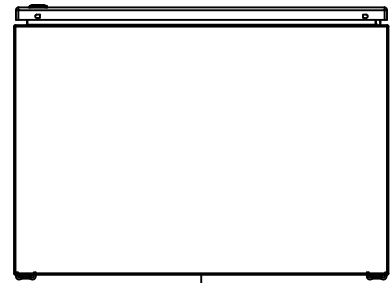

TOP

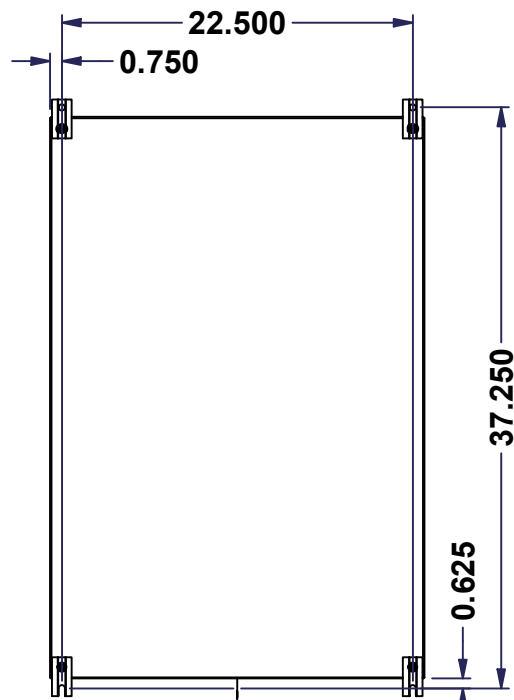

BACK

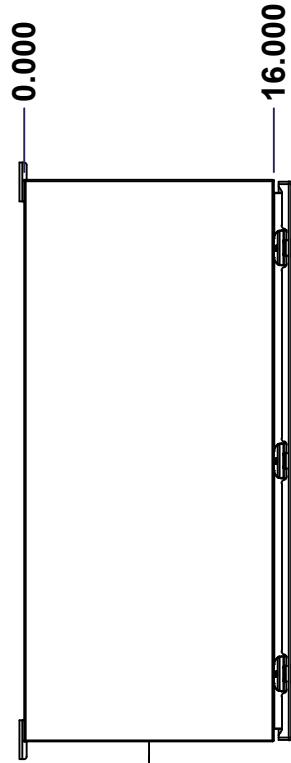

LEFT

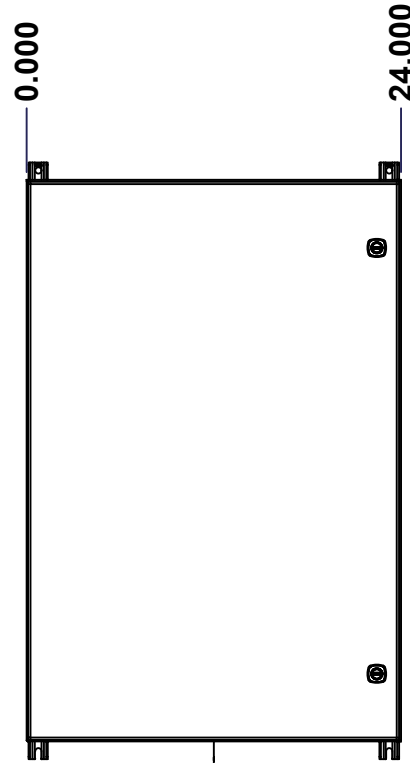

FRONT

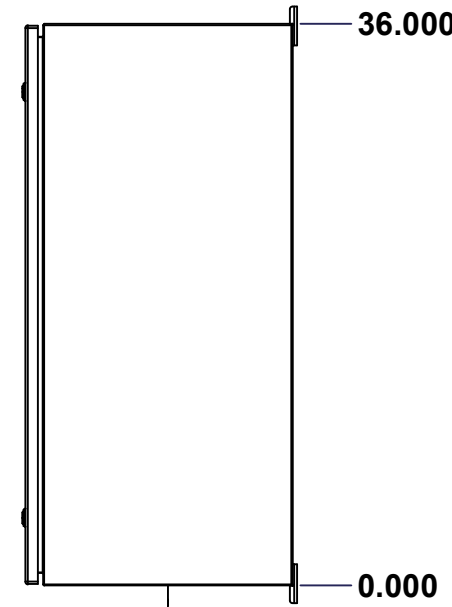

RIGHT

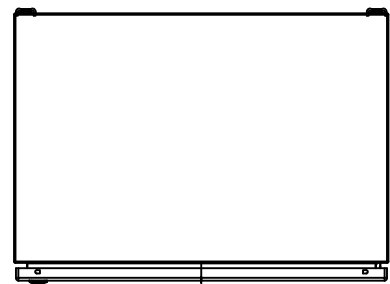

BOTTOM

| No. | Revisions | Date | By/Par |
|-----|-----------|------|--------|
| | | | |
| | | | |
| | | | |
| | | | |

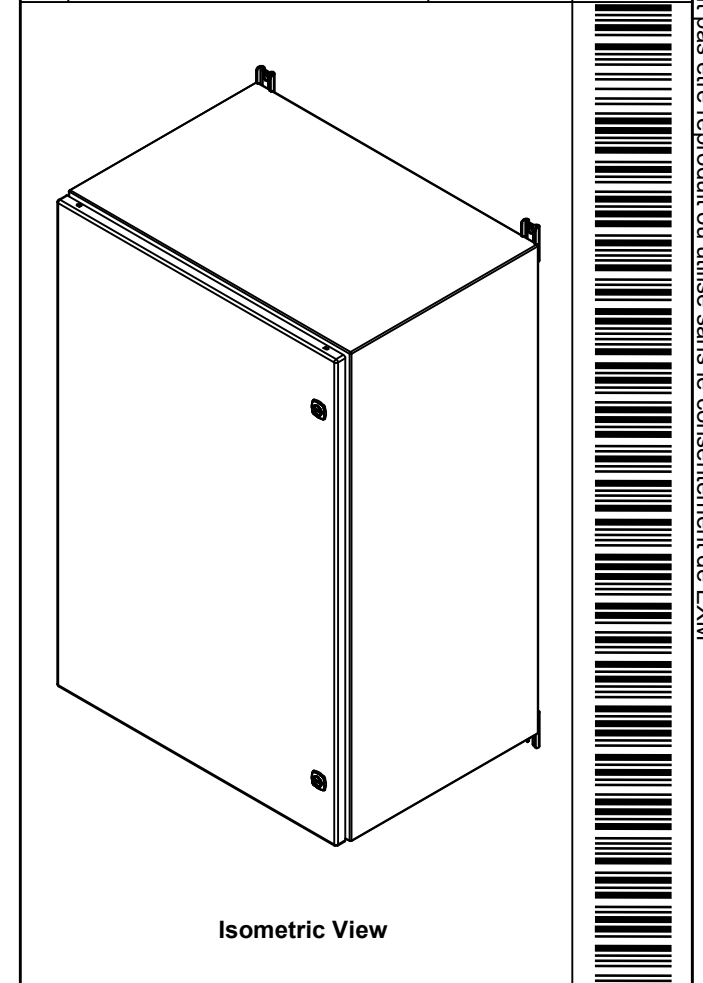

Isometric View

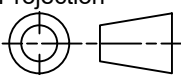

| | | |
|--|---|---|
|  Tél: (450) 979-4373 Fax: (450) 979-4626 www.exmweb.com | | Flatness Aplatissement Max 3.0mm Projection  |
| Customer Client | Date | |
| Drawn By Dessiné Par | BoxCad: BoxCad | Date 11-Apr-23 |
| Material Matière | 16 Ga Cold Rolled A1008 CS Type B (1.4mm) | |
| Color Couleur | Asa-61 Grey | Finish Fini Smooth |
| Description 5412ESBU 36" x 24" x 16" Assembly | | Detail Rev. |
| Part Number Numéro Pièce | Rev. 0 | 1 / 16 |

SEE BILL OF MATERIAL ON LAST PAGE **5412ESBU362416THNOIP**

This drawing is confidential and must not be reproduced or used without the consent of EXM

Ce dessin est confidentiel et ne doit pas être reproduit ou utilisé sans le consentement de EXM

| NOTE | |
|------|---|
| ITEM | DESCRIPTION |
| 1 | NEMA 4/12 Enclosure |
| 2 | C/W Standard ground studs on box and cover |
| 3 | C/W Standard door stiffener |
| 4 | W/O Inner panel |
| 5 | C/W Standard inner panel mounting studs |
| 6 | C/W 885 ESMF3_OPEN Sold separately (Installed) |
| 7 | C/W 885 ESMF3_CLOSE Sold separately (Installed) |
| 8 | C/W R5 Insulation (Installed by EXM) |

| No. | Revisions | Date | By/Par |
|-----|-----------|------|--------|
| | | | |
| | | | |
| | | | |
| | | | |
| | | | |
| | | | |

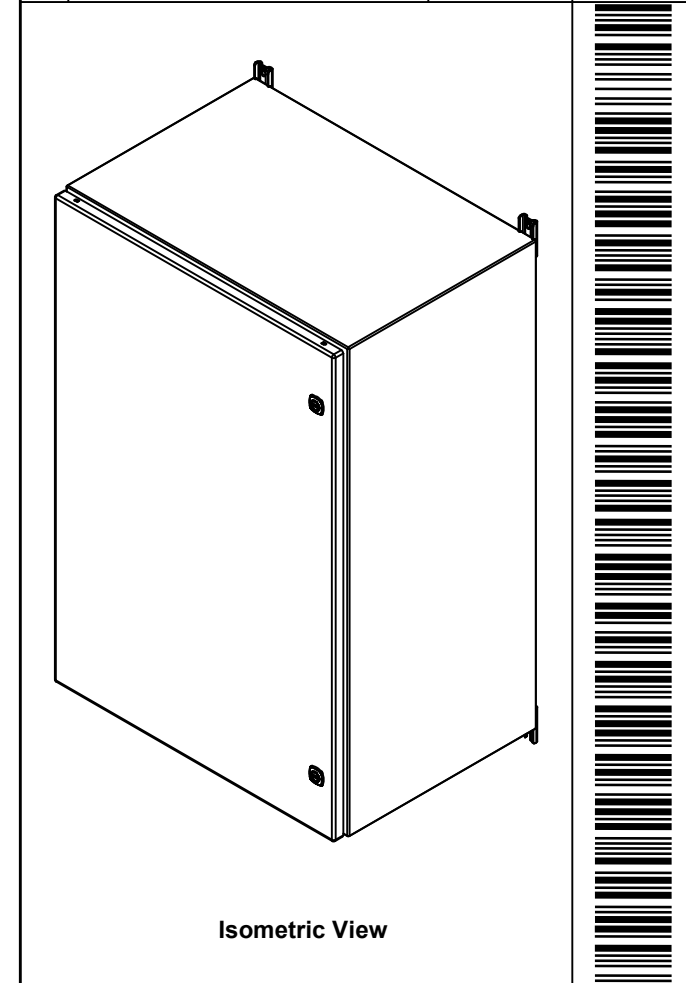



Tél: (450) 979-4373
Fax: (450) 979-4626
www.exmweb.com

Flatness
Aplatissement
Max 3.0mm

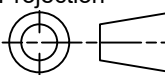
Projection

| | |
|---|----------------|
| Customer Client | Date |
| Drawn By Dessiné Par BoxCad: BoxCad | Date 11-Apr-23 |
| Material Matière 16 Ga Cold Rolled A1008 CS Type B (1.4mm) | |

| PACKING | | |
|-----------------------|-----|--|
| ITEM | QTY | DESCRIPTION |
| Cardboard sleeve | 2 | Top and Bottom |
| Cardboard strip | 2 | Between back of enclosure and inner panel |
| Plastic bag | 1 | To protect cover surface and inside gasket |
| Plastic strap - Black | 2 | To Squeeze the 2 cardboard sleeve together |
| Packaging label | 1 | White label with product number |

| | | | |
|------------|---------------------------|-----|--|
| 6 | STK-Q-00600 | 2 | M12 to M8 Adaptor |
| 1 | STK-K-01800 | 5 | 5412 ES Accessory Kit |
| 1 | 5412ESBU362416THNOI PC | 0 | 5412ESBU 36" x 24" Cover |
| 1 | 5412ESBU362416THNOI PB | 0 | 5412ESBU 36" x 24" x 16" Body |
| 6 | STK-Q-04050-08 | 0 | M6 x 8mm Hexagon Socket Head Machine Screw |
| Qty | Part Number | Rev | Description |
| Parts List | | | |

| | | | |
|-----------------------------|-----------------------------------|----------------|---------------|
| Color Couleur | Asa-61 Grey | Finish Fini | Smooth |
| Description | 5412ESBU 36" x 24" x 16" Assembly | | |
| Part Number Numéro Pièce | 5412ESBU362416THNOIP | | Rev. 0 |
| | | | 2 16 |

This drawing is confidential and must not be reproduced or used without the consent of EXM

Ce dessin est confidentiel et ne doit pas être reproduit ou utilisé sans le consentement de EXM

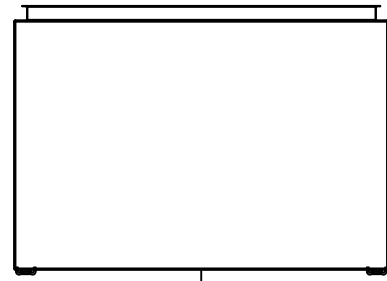

TOP

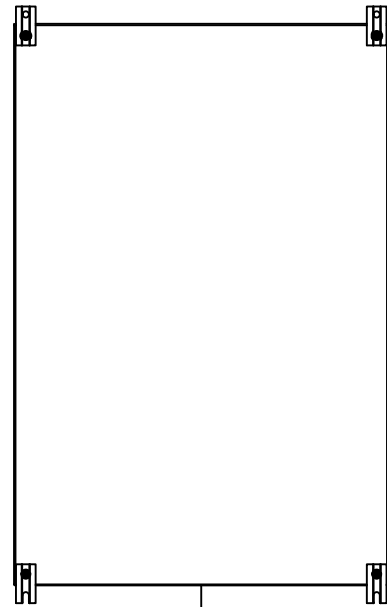

BACK

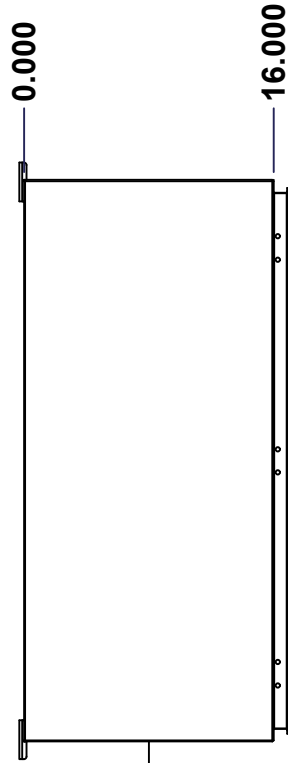

LEFT

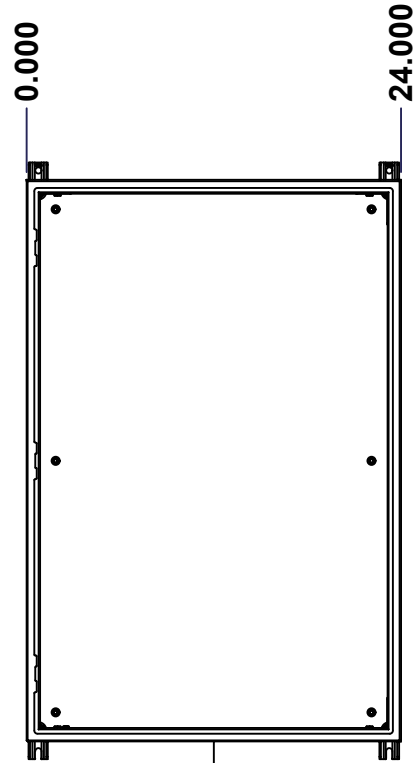

FRONT

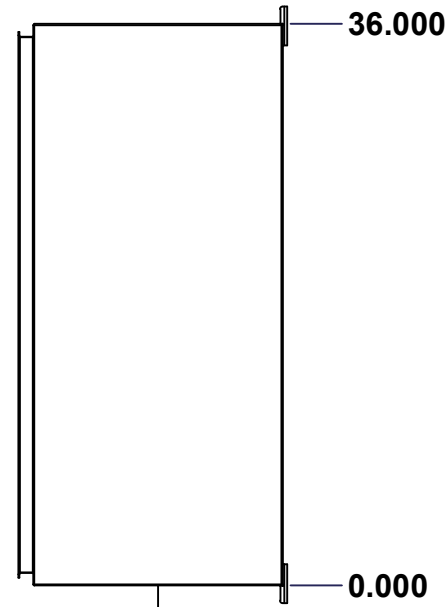

RIGHT

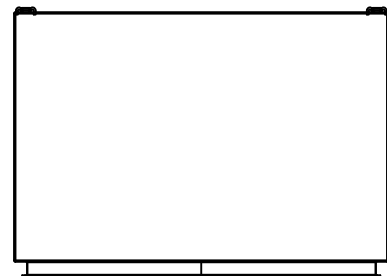

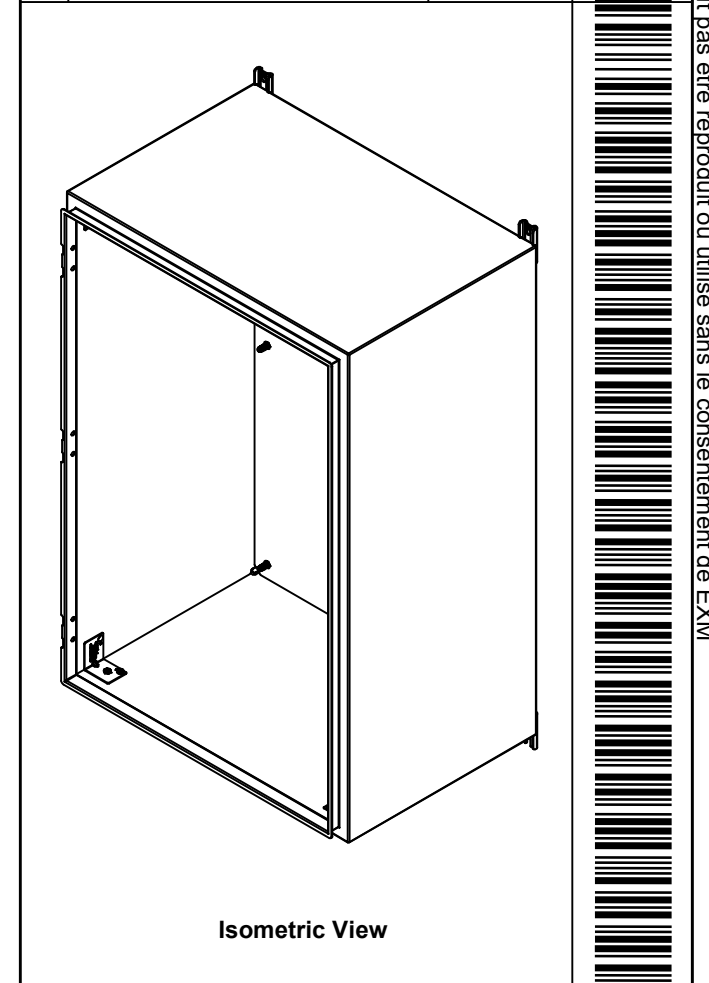

BOTTOM

| No. | Revisions | Date | By/Par |
|-----|-----------|------|--------|
| | | | |
| | | | |
| | | | |
| | | | |



Isometric View

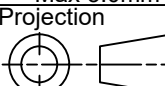

| | | |
|--|---|---|
|  Tél: (450) 979-4373 Fax: (450) 979-4626 www.exmweb.com | | Flatness Aplatissement  Max 3.0mm Projection  |
| Customer Client | Date | |
| Drawn By Dessiné Par | BoxCad: BoxCad | Date 11-Apr-23 |
| Material Matière | 16 Ga Cold Rolled A1008 CS Type B (1.4mm) | |
| Color Couleur | Asa-61 Grey | Finish Fini Smooth |
| Description | Detail Rev. | |
| 5412ESBU 36" x 24" x 16" Body | | |
| Part Number Numéro Pièce | Rev. 0 | 3 |

SEE BILL OF MATERIAL ON LAST PAGE 5412ESBU362416THNOIPB

This drawing is confidential and must not be reproduced or used without the consent of EXM

Ce dessin est confidentiel et ne doit pas être reproduit ou utilisé sans le consentement de EXM

| STANDARD FEATURES ARE NOT LISTED IN THIS HOLE TABLE | | | |
|---|--------|--------|--------------------------------|
| HOLE TABLE - TOP VIEW (CUSTOM FEATURE ONLY) | | | |
| CUT-OUT | XDIM | YDIM | DESCRIPTION |
| 1 | 2.000 | 14.500 | INSUL. STUD M6 x 18mm (Inside) |
| 2 | 22.000 | 14.500 | INSUL. STUD M6 x 18mm (Inside) |



| | | |
|--|-------------------------------|----------|
| | Description | Status |
| | 5412ESBU 36" x 24" x 16" Body | (NULL) |
| | Part Number Numéro Pièce | Rev. |
| | 5412ESBU362416THNOIPB | 0 |
| | | 4 |
| | | 16 |

This drawing is confidential and must not be reproduced or used without the consent of EXM

Ce dessin est confidentiel et ne doit pas être reproduit ou utilisé sans le consentement de EXM

| STANDARD FEATURES ARE NOT LISTED IN THIS HOLE TABLE | | | |
|---|--------|--------|--------------------------------|
| HOLE TABLE - BOTTOM VIEW (CUSTOM FEATURE ONLY) | | | |
| CUT-OUT | XDIM | YDIM | DESCRIPTION |
| 1 | 2.000 | 14.500 | INSUL. STUD M6 x 18mm (Inside) |
| 2 | 22.000 | 14.500 | INSUL. STUD M6 x 18mm (Inside) |

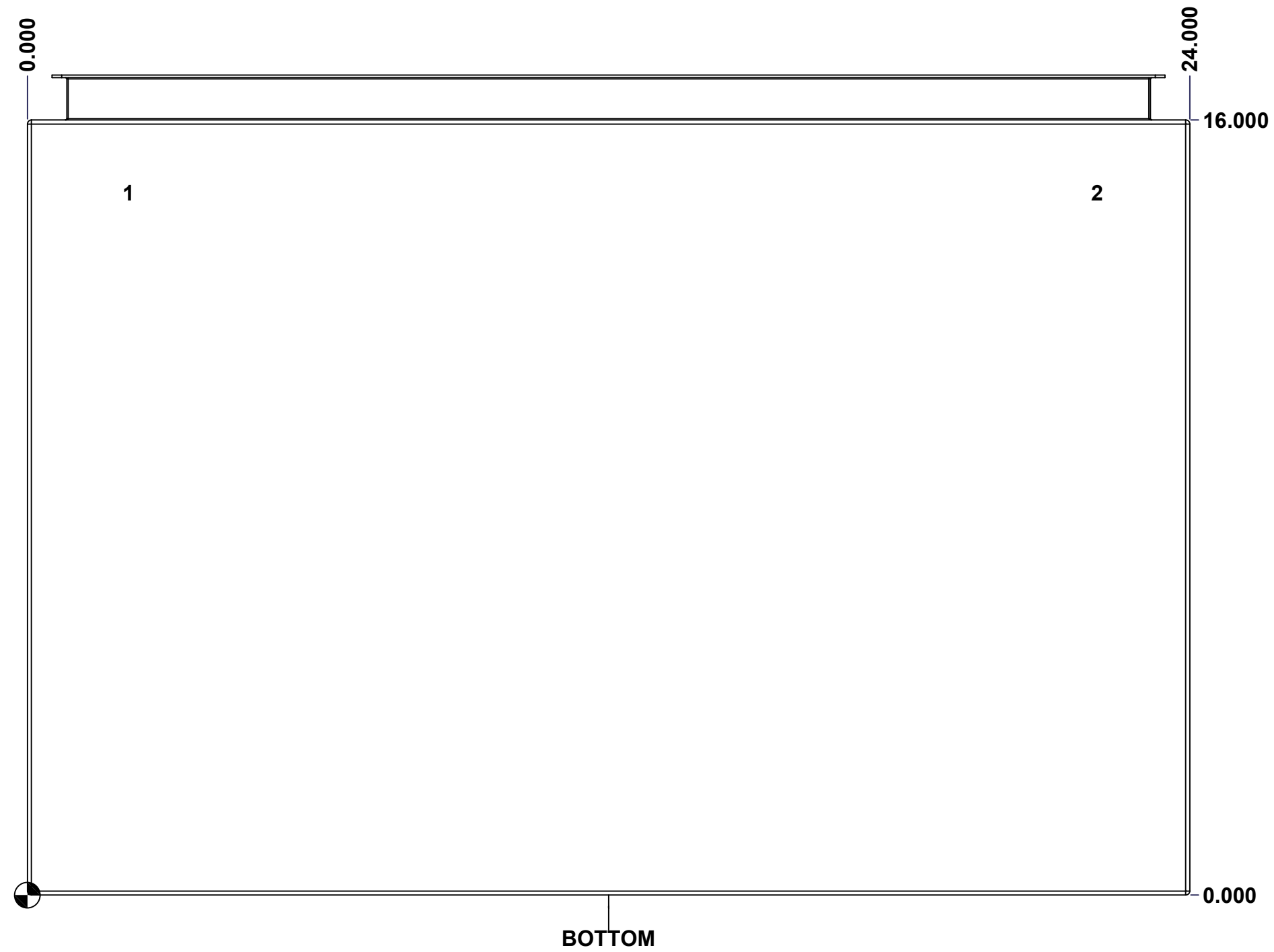

| | | |
|--|-------------------------------|----------|
| | Description | Status |
| | 5412ESBU 36" x 24" x 16" Body | (NULL) |
| | Part Number Numéro Pièce | Rev. |
| | 5412ESBU362416THNOIPB | 0 |
| | | 5 |
| | | 16 |

This drawing is confidential and must not be reproduced or used without the consent of EXM

Ce dessin est confidentiel et ne doit pas être reproduit ou utilisé sans le consentement de EXM

STANDARD FEATURES ARE NOT LISTED IN THIS HOLE TABLE

HOLE TABLE - BACK VIEW (CUSTOM FEATURE ONLY)

| CUT-OUT | XDIM | YDIM | DESCRIPTION |
|---------|--------|--------|----------------------------|
| 1 | 1.875 | 1.875 | IP STUD M8 x 35mm (Inside) |
| 2 | 1.875 | 34.125 | IP STUD M8 x 35mm (Inside) |
| 3 | 22.125 | 34.125 | IP STUD M8 x 35mm (Inside) |
| 4 | 22.125 | 1.875 | IP STUD M8 x 35mm (Inside) |
| 5 | 1.875 | 18.000 | IP STUD M8 x 35mm (Inside) |
| 6 | 22.125 | 18.000 | IP STUD M8 x 35mm (Inside) |
| ----- | | | |
| 7 | 23.250 | 0.000 | FOOT 885 ESMF3_OPEN |
| 8 | 0.750 | 0.000 | FOOT 885 ESMF3_OPEN |
| 9 | 23.250 | 36.000 | FOOT 885 ESMF3_CLOSE |
| 10 | 0.750 | 36.000 | FOOT 885 ESMF3_CLOSE |

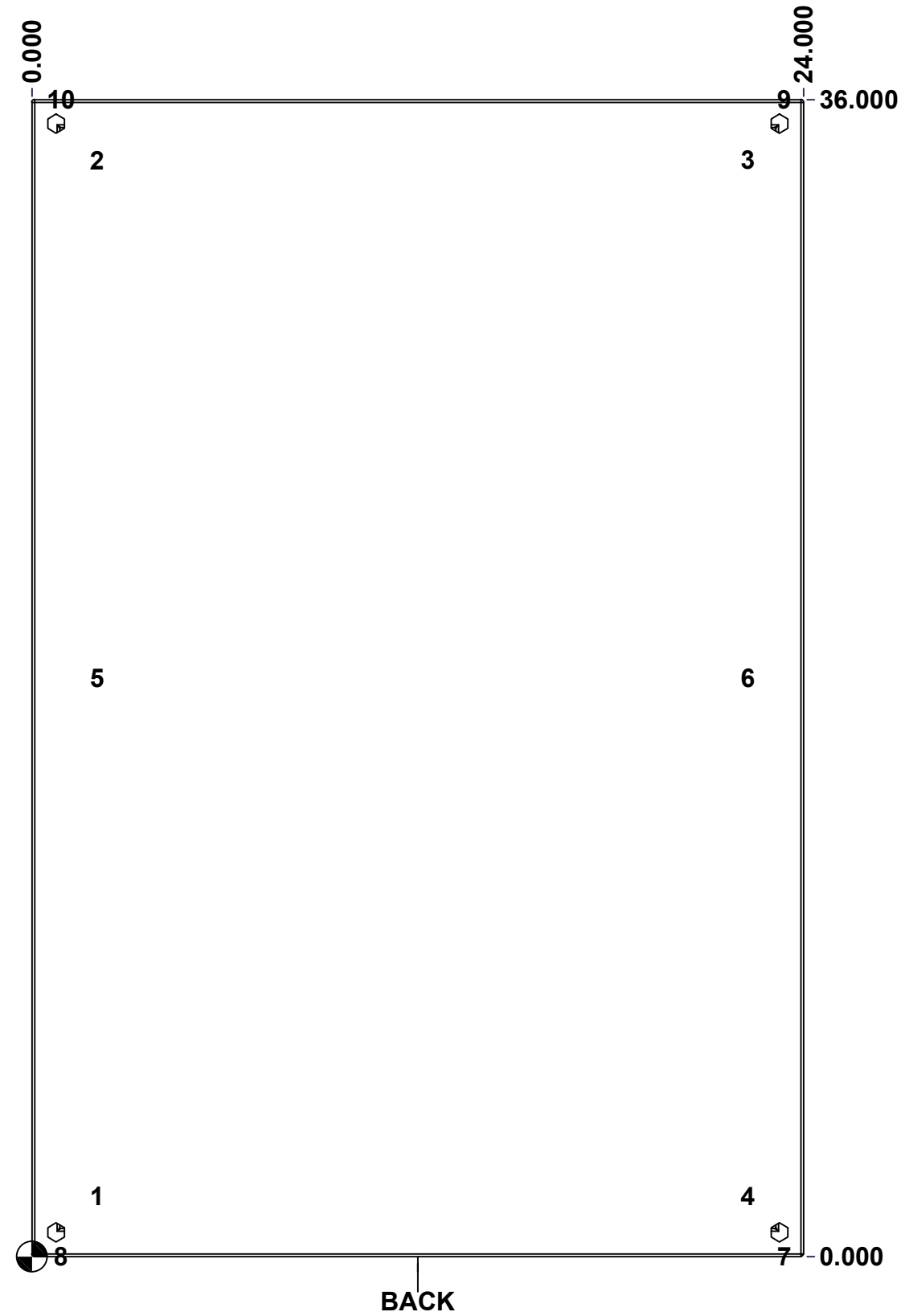

BACK

| | | |
|---|-------------------------------|--------|
| | Description | Status |
| | 5412ESBU 36" x 24" x 16" Body | (NULL) |
| Part Number Numéro Pièce 5412ESBU362416THNOIPB | Rev. | 6 |
| | 0 | 16 |

This drawing is confidential and must not be reproduced or used without the consent of EXM

Ce dessin est confidentiel et ne doit pas être reproduit ou utilisé sans le consentement de EXM

| No. | Revisions | Date | By/Par |
|-----|-----------|------|--------|
| | | | |
| | | | |
| | | | |
| | | | |
| | | | |

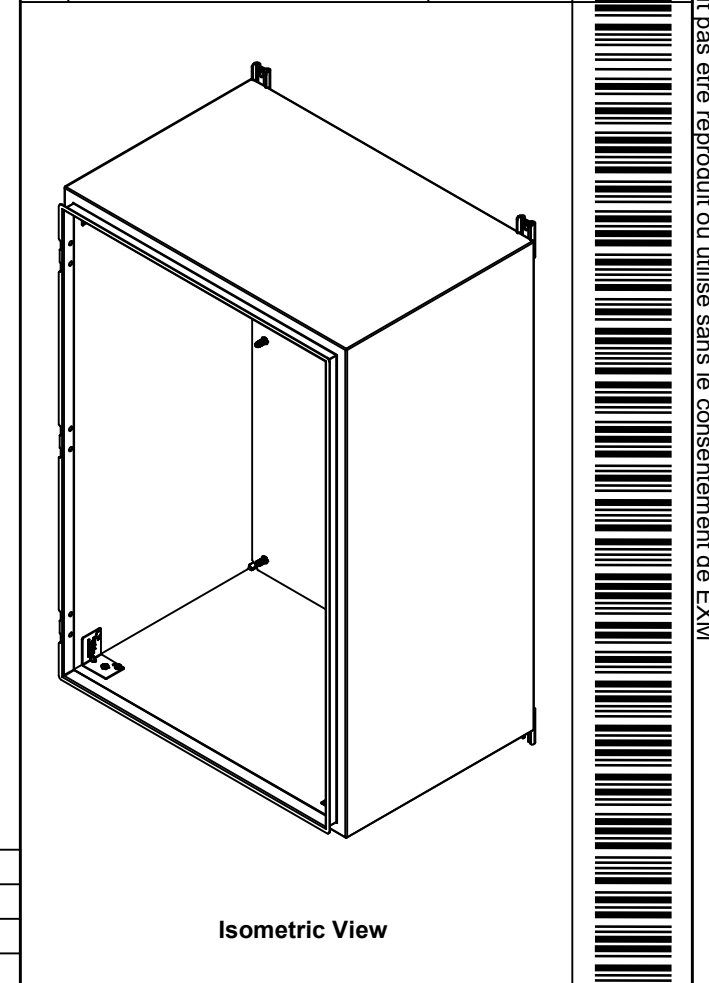

| | | | |
|---|------------------------------|---|--|
| 2 | 885ESMF3-FEET | 0 | 885 ESMF3 Mounting Foot |
| 4 | RIVET_NUT_M10_FH_CE | 0 | Rivet Nut M10 (Low Profile Close End) |
| 4 | STK-Q-06660 | 2 | M10 x 16mm Machine Screw |
| 2 | 885ESMF3-FEET-A | 0 | 885 ESMF3 Mounting Foot (Opened Slot) |
| 1 | STK-K-70554 | 3 | 5412 ESTH Accessory Kit |
| 1 | 5412ESBU362416THNOI PI-RS | 0 | 5412ESBU 36" x 24" Right Insulation |
| 1 | 5412ESBU362416THNOI PI-LS | 0 | 5412ESBU 36" x 24" Left Insulation |
| 1 | 5412ESBU362416THNOI PI-BT | 0 | 5412ESBU 36" x 24" Top and Bottom Insulation |
| 1 | 5412ESBU362416THNOI PI-TP | 0 | 5412ESBU 36" x 24" Top and Bottom Insulation |
| 1 | 5412ESBU362416THNOI PI-B | 0 | 5412ESBU 36" x 24" Back Insulation |
| 4 | STK-Q-16055 | 1 | M6 x 18mm Stud (No Paint Cap Required) |
| 1 | STK-P-02400S | 0 | Powder Paint (Asa-61 Grey / Smooth) |
| 6 | STK-Q-16005 | 1 | Stud M8 x 35 (No Paint Cap Required) |
| 1 | 5412ESBU362416THNOI PB-P | 0 | 5412ESBU 36" x 24" x 16" Body Part |

| Qty | Part Number | Rev | Description |
|------------|-------------|-----|-------------|
| Parts List | | | |

| | | | |
|--|--|--|--------|
| | Tél: (450) 979-4373 Fax: (450) 979-4626 www.exmweb.com | Flatness Aplatissement Max 3.0mm | |
| | Projection | Customer Client | Date |
| Drawn By Dessiné Par | BoxCad: BoxCad | Date 11-Apr-23 | |
| Material Matière | 16 Ga Cold Rolled A1008 CS Type B (1.4mm) | | |
| Color Couleur | Asa-61 Grey | Finish Fini | Smooth |
| Description 5412ESBU 36" x 24" x 16" Body | | Detail Rev. | |
| Part Number Numéro Pièce | | Rev. | 7 |
| 5412ESBU362416THNOIPB | | 0 | 16 |

This drawing is confidential and must not be reproduced or used without the consent of EXM

Ce dessin est confidentiel et ne doit pas être reproduit ou utilisé sans le consentement de EXM

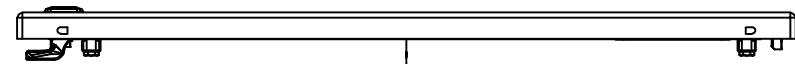

TOP

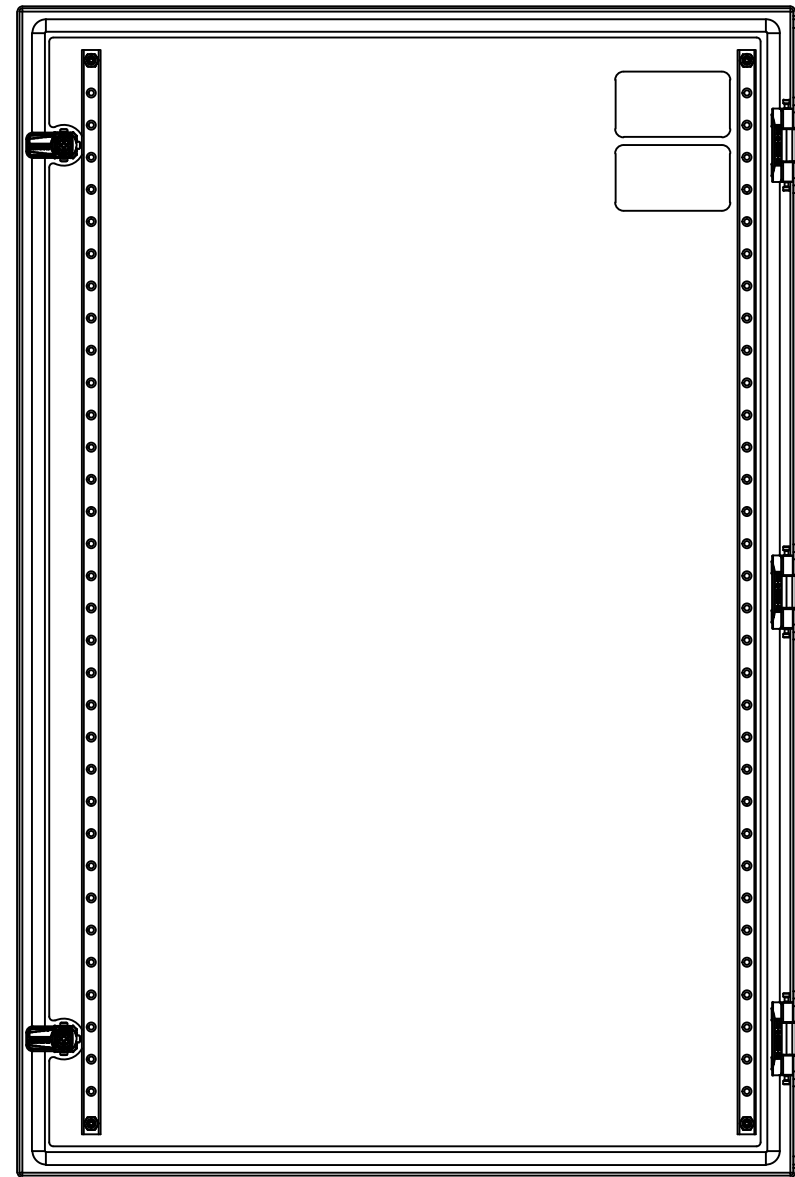

BACK

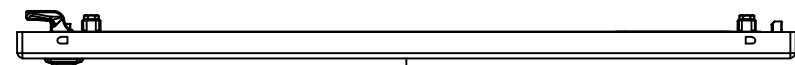

BOTTOM

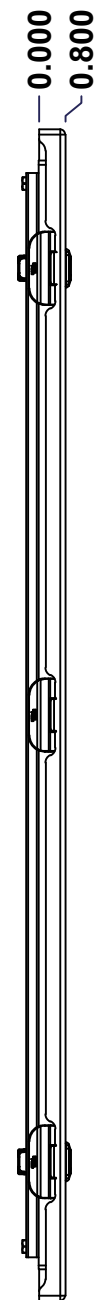

LEFT

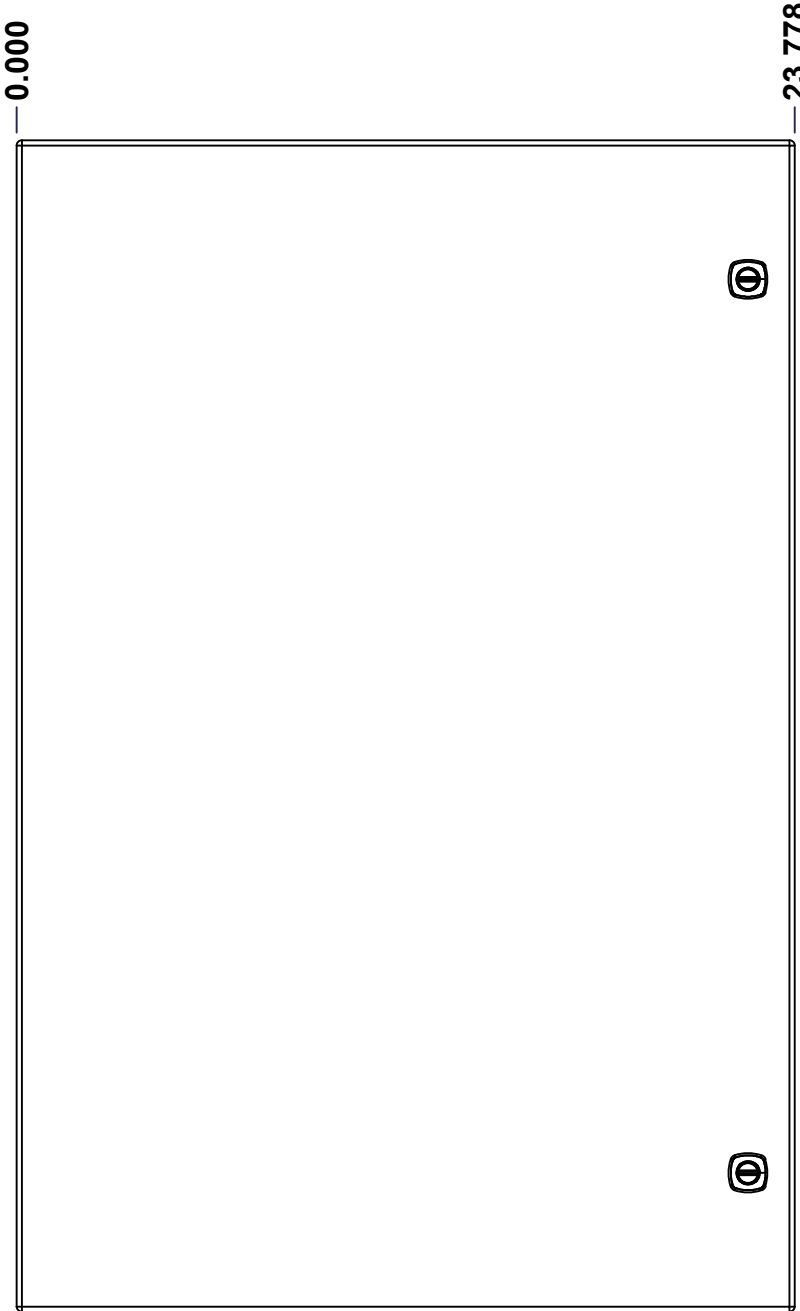

FRONT

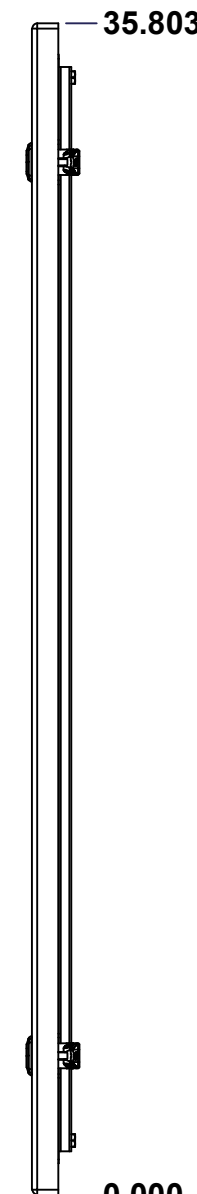

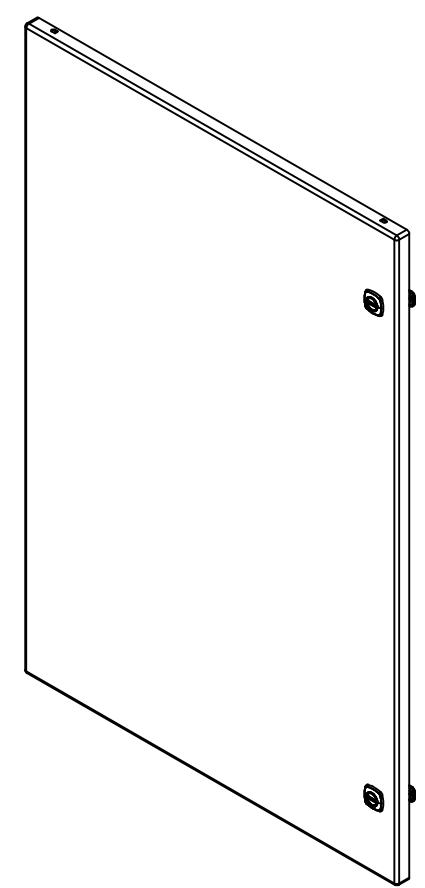

RIGHT



Isometric View

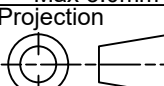

| No. | Revisions | Date | By/Par |
|-----|-----------|------|--------|
| | | | |
| | | | |
| | | | |
| | | | |

| | | |
|--|---|--|
|  Tél: (450) 979-4373 Fax: (450) 979-4626 www.exmweb.com | | Flatness Aplatissement  Max 3.0mm Projection  |
| Customer Client | Date | |
| Drawn By Dessiné Par | BoxCad: BoxCad | Date 11-Apr-23 |
| Material Matière | 14 Ga Cold Rolled A1008 CS Type B (1.7mm) | |
| Color Couleur | Asa-61 Grey | Finish Fini Smooth |
| Description | Detail Rev. | |
| 5412ESBU 36" x 24" Cover | | |
| Part Number Numéro Pièce | Rev. 8 | |
| SEE BILL OF MATERIAL ON LAST PAGE 5412ESBU362416THNOIPC | | 0 |

This drawing is confidential and must not be reproduced or used without the consent of EXM

Ce dessin est confidentiel et ne doit pas être reproduit ou utilisé sans le consentement de EXM

| STANDARD FEATURES ARE NOT LISTED IN THIS HOLE TABLE | | | |
|---|--------|--------|-------------------------|
| HOLE TABLE - FRONT VIEW (CUSTOM FEATURE ONLY) | | | |
| CUT-OUT | XDIM | YDIM | DESCRIPTION |
| 1 | 1.486 | 1.661 | STUD M6 x 18mm (Inside) |
| 2 | 1.486 | 34.142 | STUD M6 x 18mm (Inside) |
| 3 | 21.517 | 34.142 | STUD M6 x 18mm (Inside) |
| 4 | 21.517 | 1.661 | STUD M6 x 18mm (Inside) |
| ----- | | | |
| 5 | 22.354 | 31.553 | 880 SCQ4-SL |
| 6 | 22.354 | 4.250 | 880 SCQ4-SL |

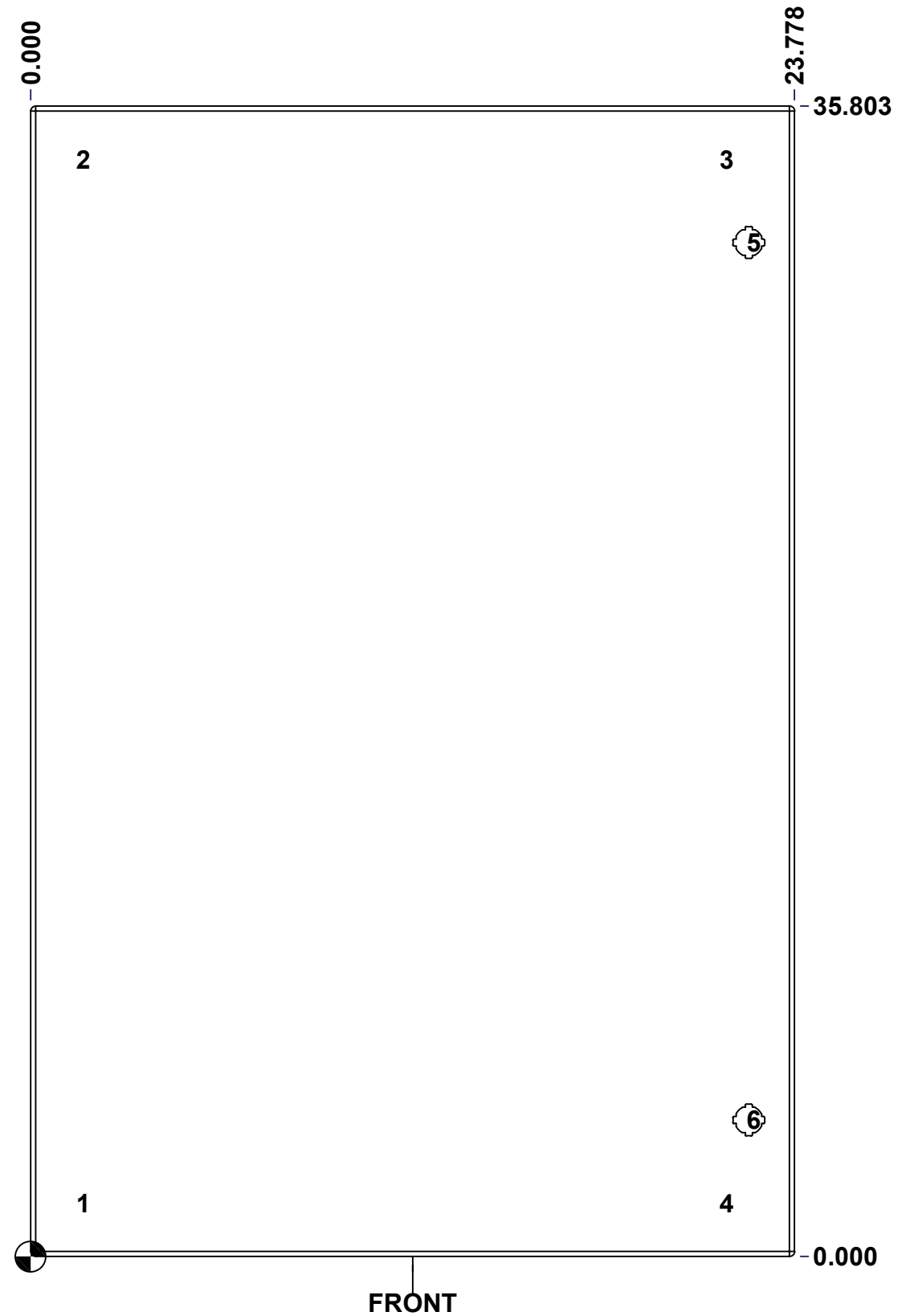

| | | |
|--|---|--------------------|
| | Description 5412ESBU 36" x 24" Cover | Status (NULL) |
| | Part Number Numéro Pièce 5412ESBU362416THNOIPC | Rev. 9 0 |

This drawing is confidential and must not be reproduced or used without the consent of EXM

Ce dessin est confidentiel et ne doit pas être reproduit ou utilisé sans le consentement de EXM

| No. | Revisions | Date | By/Par |
|-----|-----------|------|--------|
| | | | |
| | | | |
| | | | |
| | | | |
| | | | |

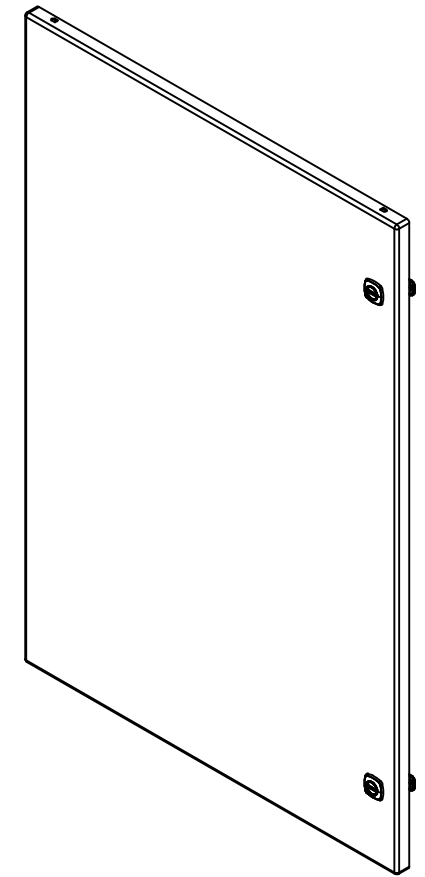

Isometric View



| QTY | Part Number | Rev | Description |
|-----|-----------------------------|-----|--|
| 2 | STK-S-00100 | 0 | 3.5" x 2" Silver Milar Flexcon Sticker |
| 4 | STK-Q-07250 | 2 | M6 x 16mm Collar Nut |
| 2 | STK-Q-46020-36 | 5 | 5412 ES Vertical Door Stiffener 36" |
| 1 | 5412ESBU362416THNOI PI-C | 0 | 5412ESBU 36" x 24" Cover Insulation |
| 1 | STK-P-02400S | 0 | Powder Paint (Asa-61 Grey / Smooth) |
| 4 | STK-Q-16055 | 1 | M6 x 18mm Stud (No Paint Cap Required) |
| 3 | STK-A-33005 | 4 | 5412 ESBU Hinge 180° (Body Part) |
| 1 | 5412ESBU362416THNOI PG | 0 | 5412ESBU 36" x 24" Cover Gasket Part |
| 1 | 5412ESBU362416THNOI PC-P | 0 | 5412ESBU 36" x 24" Cover Part |
| 2 | STK-K-12500 | 16 | 5412 ES 1/4 Turn Lock |
| | | | |
| | | | |



Tél: (450) 979-4373
Fax: (450) 979-4626
www.exmweb.com

Flatness
Aplatissement
Max 3.0mm

Projection

Customer Client

Date

Drawn By
Dessiné Par BoxCad: BoxCad

Date 11-Apr-23

Material
Matière 14 Ga Cold Rolled A1008 CS Type B (1.7mm)

Color
Couleur Asa-61 Grey

Finish
Fini Smooth

Description

5412ESBU 36" x 24" Cover

Detail Rev.

Part Number
Numéro Pièce

5412ESBU362416THNOIPC

Rev. 0

This drawing is confidential and must not be reproduced or used without the consent of EXM

Ce dessin est confidentiel et ne doit pas être reproduit ou utilisé sans le consentement de EXM

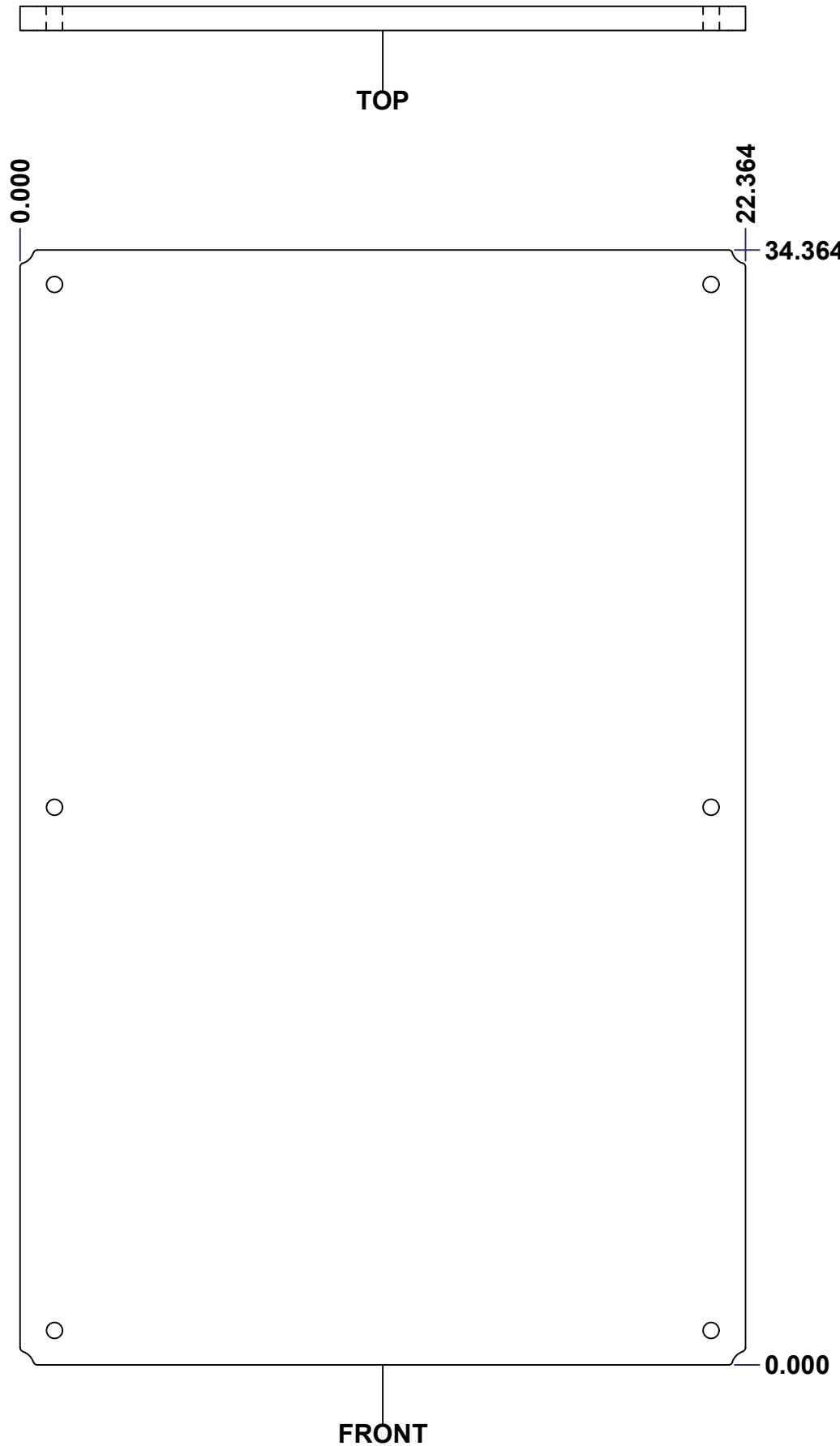

| No. | Revisions | Date | By/Par |
|-----|-----------|------|--------|
| | | | |
| | | | |
| | | | |
| | | | |
| | | | |

Isometric View

| | | |
|---|---------------------------|--|
| <p>Tél: (450) 979-4373 Fax: (450) 979-4626 www.exmweb.com</p> | | Flatness Aplatissement Max 3.0mm Projection |
| Customer Client | Date | |
| Drawn By Dessiné Par | BoxCad: Patrick Deschenes | Date 23-Jan-07 |
| Material Matière | Polyisocyanurate | |
| Color Couleur | Aluminum | Finish Fini N/A |
| Description | | Detail Rev. |
| 5412ESBU 36" x 24" Back Insulation | | |
| Part Number Numéro Pièce | Rev. | 11 |
| SEE BILL OF MATERIAL ON LAST PAGE | | 0 |

This drawing is confidential and must not be reproduced or used without the consent of EXM

Ce dessin est confidentiel et ne doit pas être reproduit ou utilisé sans le consentement de EXM

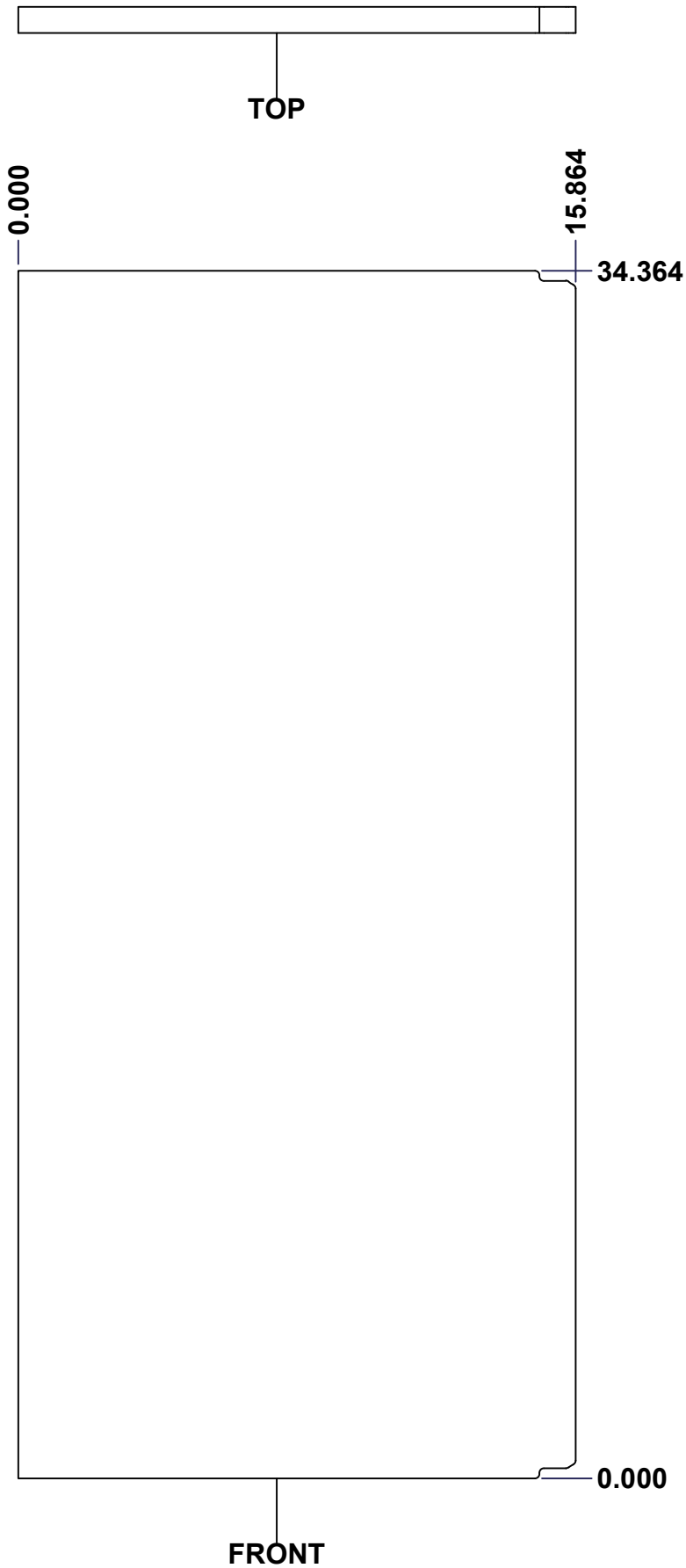

| No. | Revisions | Date | By/Par |
|-----|-----------|------|--------|
| | | | |
| | | | |
| | | | |
| | | | |
| | | | |

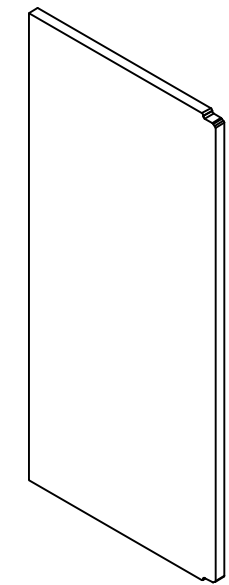

Isometric View

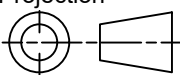

| | | |
|--|--------------------|--|
|  Tél: (450) 979-4373 Fax: (450) 979-4626 www.exmweb.com | | Flatness Aplatissement Max 3.0mm |
| Projection  | | Date 23-Jan-07 |
| Customer Client | Date | |
| Drawn By / Dessiné Par: BoxCad: Patrick Deschenes | Date: 23-Jan-07 | |
| Material / Matière: Polyisocyanurate | | |
| Color / Couleur: Aluminum | Finish / Fini: N/A | |
| Description: 5412ESBU 36" x 24" Left Insulation | Detail Rev. | |
| Part Number / Numéro Pièce: 5412ESBU362416THNOIPI-LS | Rev.: | 12 |
| SEE BILL OF MATERIAL ON LAST PAGE | | 16 |

This drawing is confidential and must not be reproduced or used without the consent of EXM

Ce dessin est confidentiel et ne doit pas être reproduit ou utilisé sans le consentement de EXM

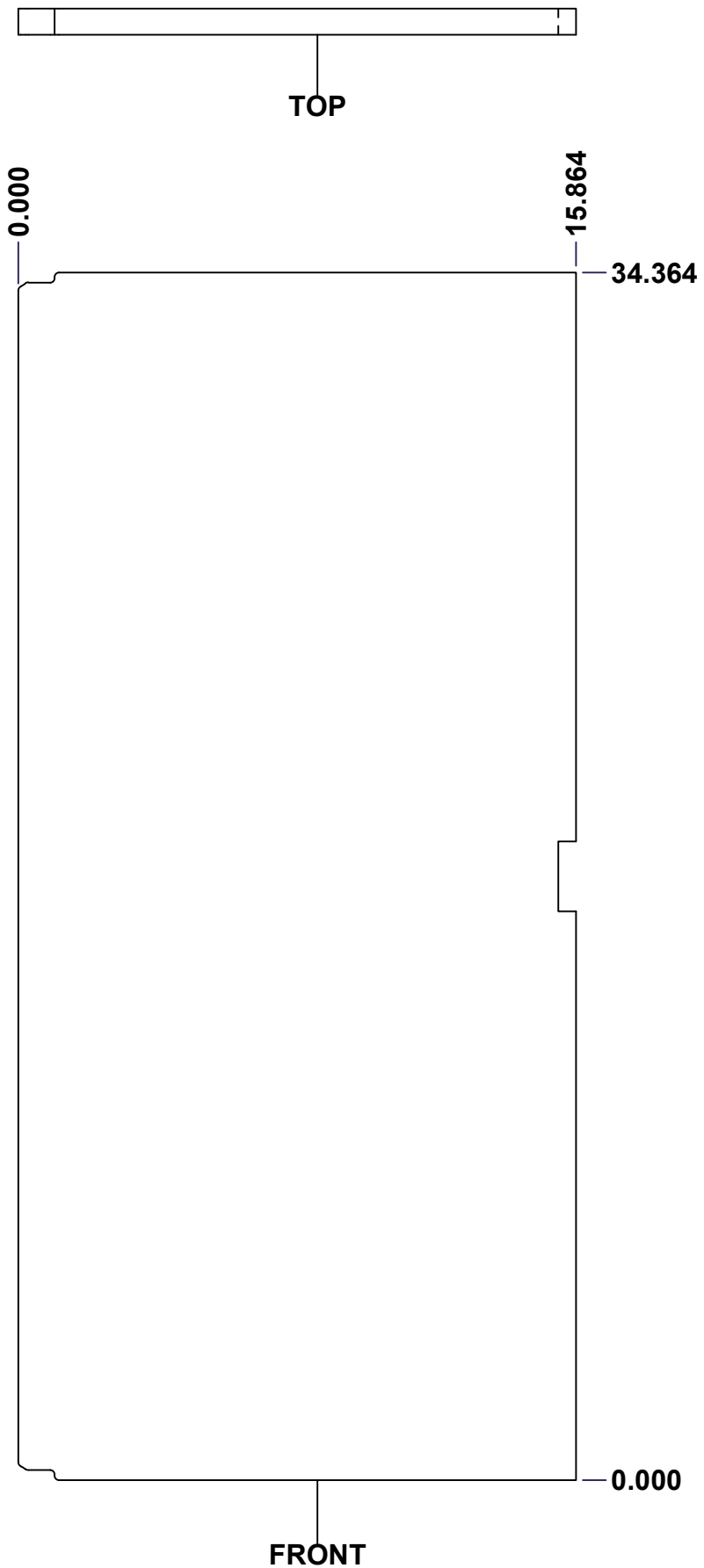

| No. | Revisions | Date | By/Par |
|-----|-----------|------|--------|
| | | | |
| | | | |
| | | | |
| | | | |
| | | | |

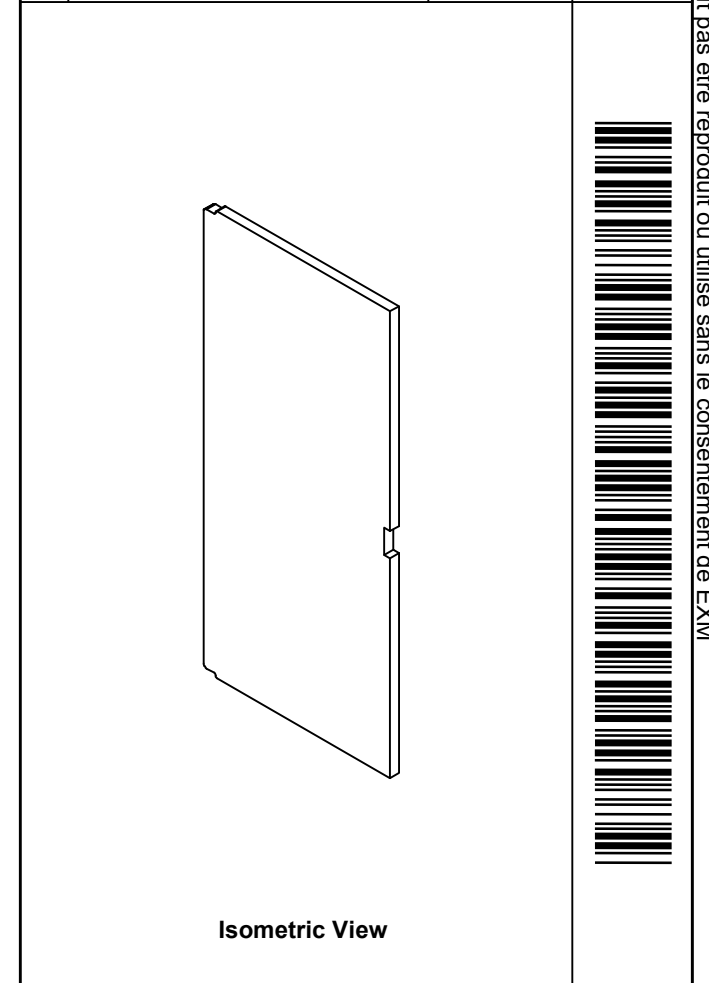

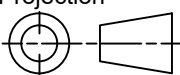
| | | |
|--|--------------------|---|
|  Tél: (450) 979-4373 Fax: (450) 979-4626 www.exmweb.com | | Flatness Aplatissement Max 3.0mm Projection  |
| Customer Client | Date | |
| Drawn By / Dessiné Par: BoxCad: Patrick Deschenes | Date: 23-Jan-07 | |
| Material / Matière: Polyisocyanurate | | |
| Color / Couleur: Aluminum | Finish / Fini: N/A | |
| Description: 5412ESBU 36" x 24" Right Insulation | | Detail Rev. |
| Part Number / Numéro Pièce | Rev. 13 | 16 |

SEE BILL OF MATERIAL ON LAST PAGE 5412ESBU362416THNOIPI-RS 0

This drawing is confidential and must not be reproduced or used without the consent of EXM

Ce dessin est confidentiel et ne doit pas être reproduit ou utilisé sans le consentement de EXM

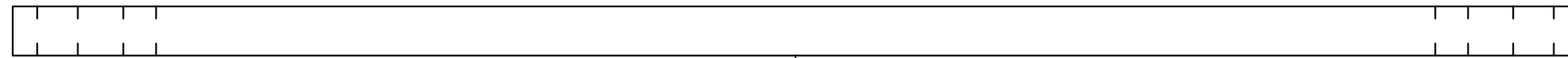

TOP



FRONT

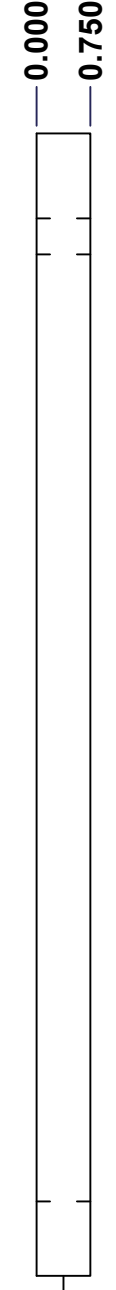

RIGHT

| No. | Revisions | Date | By/Par |
|-----|-----------|------|--------|
| | | | |
| | | | |
| | | | |
| | | | |

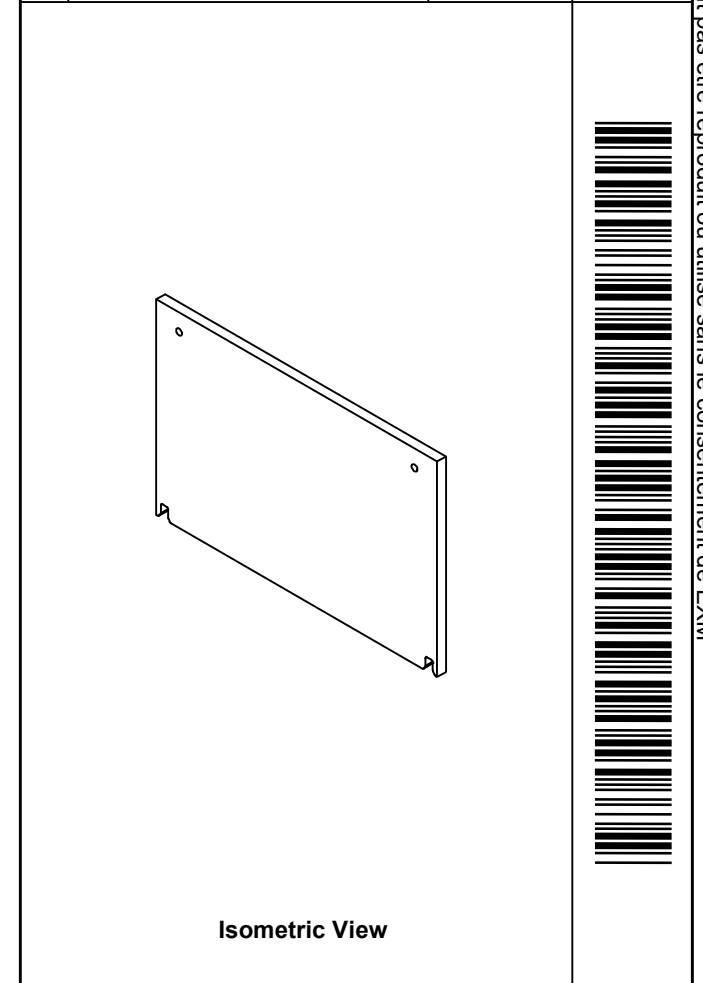

Isometric View



Tél: (450) 979-4373
 Fax: (450) 979-4626
www.exmweb.com

Flatness
 Aplatissement
 Max 3.0mm
 Projection

| | |
|---|--------------------|
| Customer Client | Date |
| Drawn By / Dessiné Par: BoxCad: Patrick Deschenes | Date: 23-Jan-07 |
| Material / Matière: Polyisocyanurate | |
| Color / Couleur: Aluminum | Finish / Fini: N/A |

| | |
|---|-------------|
| Description: 5412ESBU 36" x 24" Top and Bottom Insulation | Detail Rev. |
| Part Number / Numéro Pièce | Rev. 14 |

SEE BILL OF MATERIAL ON LAST PAGE 5412ESBU362416THNOIPI-TP 0

This drawing is confidential and must not be reproduced or used without the consent of EXM

Ce dessin est confidentiel et ne doit pas être reproduit ou utilisé sans le consentement de EXM

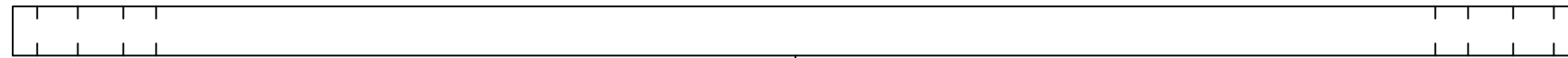

TOP



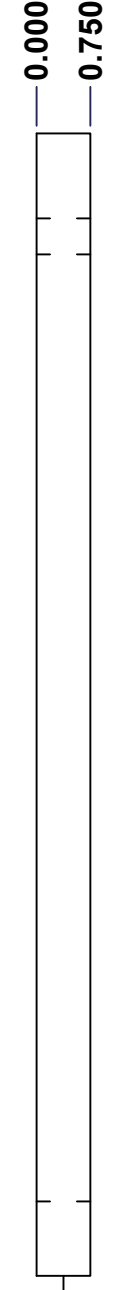

FRONT

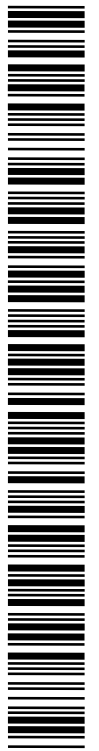
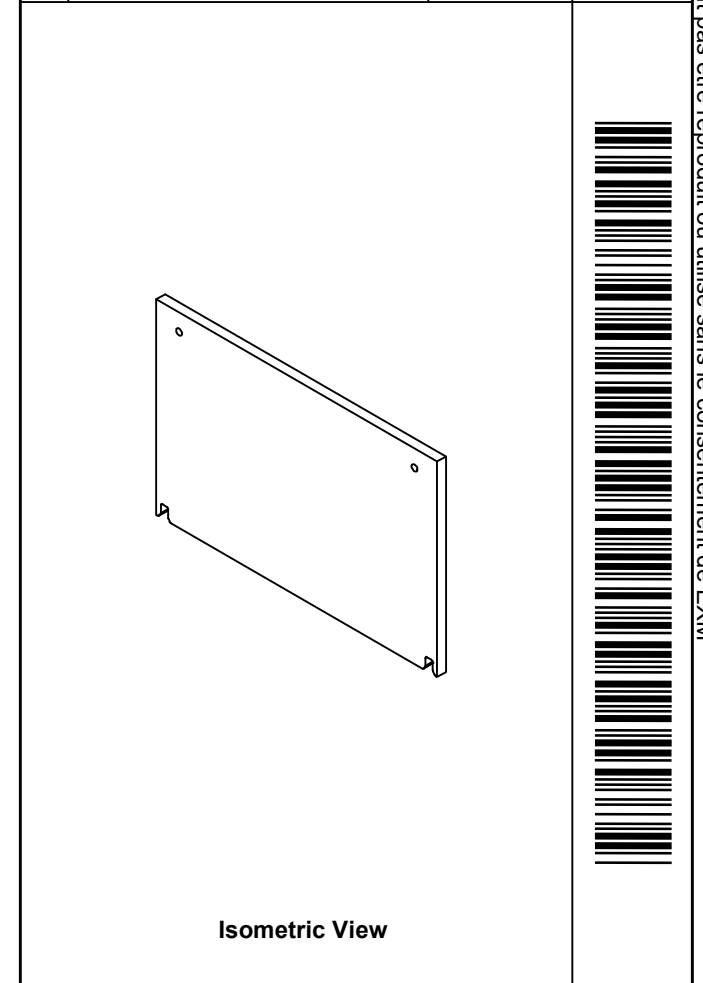

RIGHT

| No. | Revisions | Date | By/Par |
|-----|-----------|------|--------|
| | | | |
| | | | |
| | | | |
| | | | |
| | | | |



| | | | |
|--|--|---------------------------|-------------|
|  Tél: (450) 979-4373 Fax: (450) 979-4626 www.exmweb.com | | Flatness Aplatissement | |
| | | Max 3.0mm | |
| Customer Client | | Date | |
| Drawn By Dessiné Par | | Date | |
| Material Matière | | Polyisocyanurate | |
| Color Couleur | | Finish Fini | |
| Aluminum | | N/A | |
| Description | | | Detail Rev. |
| 5412ESBU 36" x 24" Top and Bottom Insulation | | | |
| Part Number Numéro Pièce | | Rev. | 15 |
| SEE BILL OF MATERIAL ON LAST PAGE | | 5412ESBU362416THNOIPI-BT | 0 |

This drawing is confidential and must not be reproduced or used without the consent of EXM

Ce dessin est confidentiel et ne doit pas être reproduit ou utilisé sans le consentement de EXM

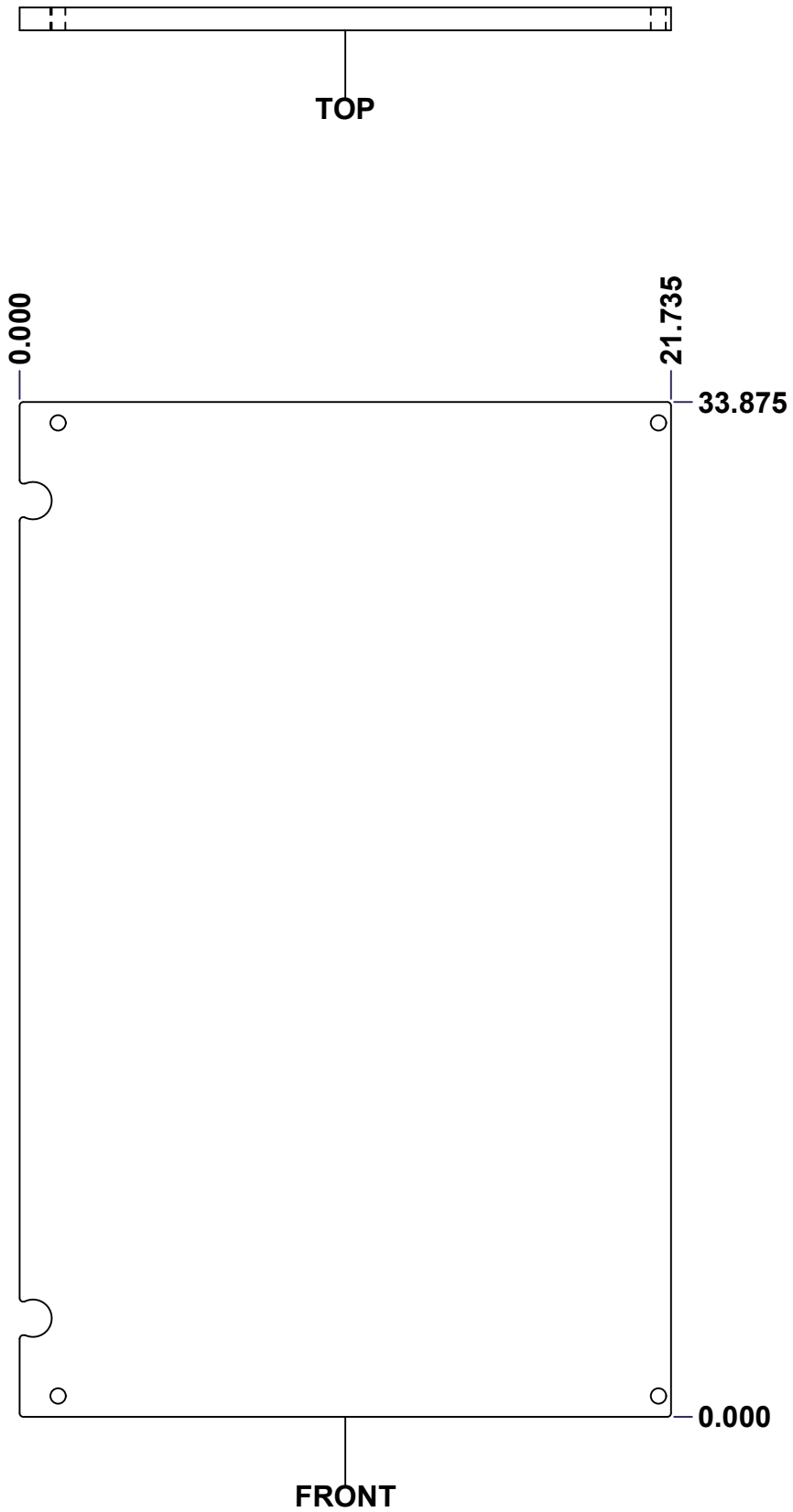

| No. | Revisions | Date | By/Par |
|-----|-----------|------|--------|
| | | | |
| | | | |
| | | | |
| | | | |
| | | | |

Isometric View

| | | |
|--|---------------------------|--|
| Tél: (450) 979-4373 Fax: (450) 979-4626 www.exmweb.com | | Flatness Aplatissement Max 3.0mm Projection |
| Customer Client | Date | |
| Drawn By Dessiné Par | BoxCad: Patrick Deschenes | Date 23-Jan-07 |
| Material Matière | Polyisocyanurate | |
| Color Couleur | Aluminum | Finish Fini N/A |
| Description | | Detail Rev. |
| 5412ESBU 36" x 24" Cover Insulation | | |
| Part Number Numéro Pièce | Rev. | 16 |
| SEE BILL OF MATERIAL ON LAST PAGE 5412ESBU362416THNOIPI-C 0 | | 16 |