

This drawing is confidential and must not be reproduced or used without the consent of EXM

Ce dessin est confidentiel et ne doit pas être reproduit ou utilisé sans le consentement de EXM

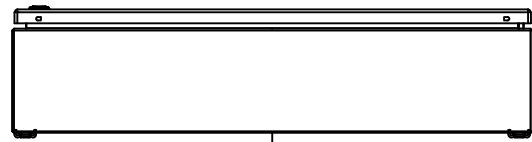

TOP

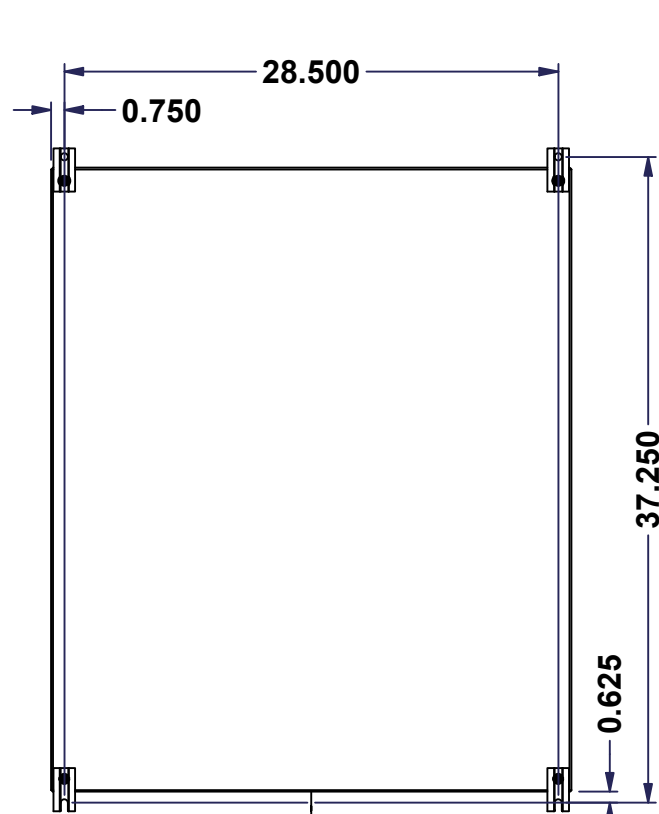

BACK

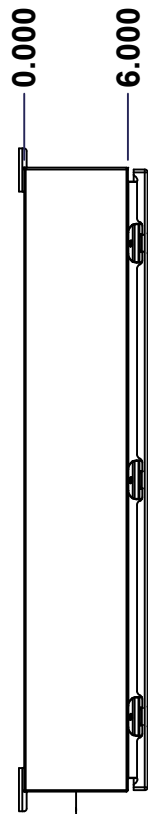

LEFT

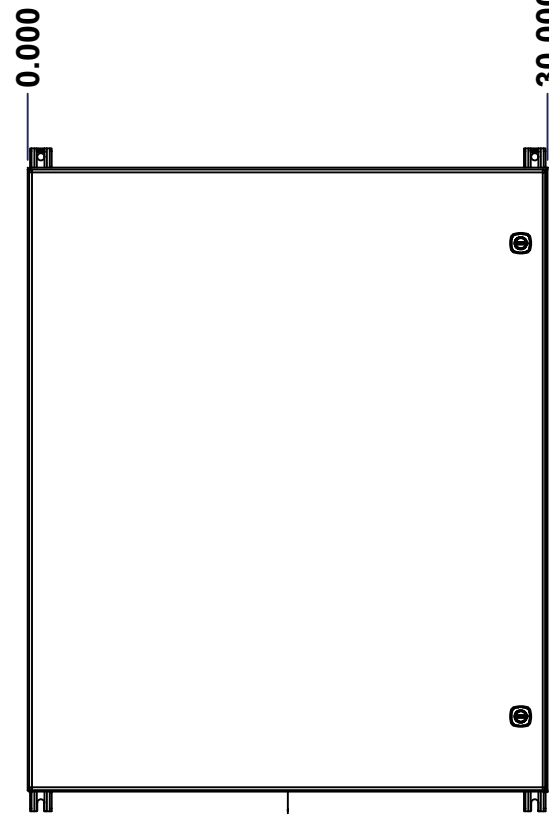

FRONT

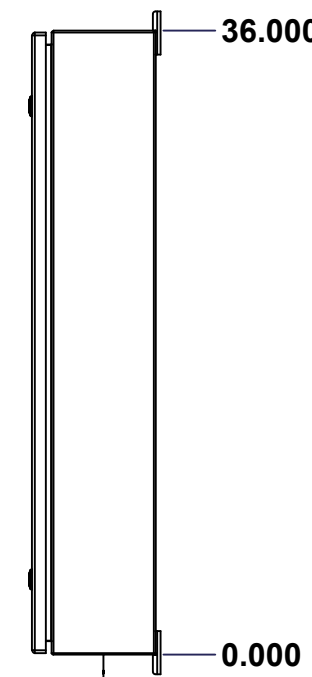

RIGHT

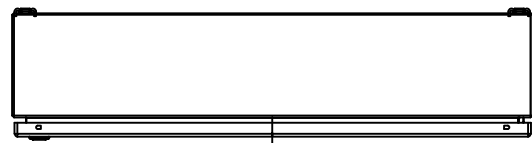

BOTTOM

No.	Revisions	Date	By/Par

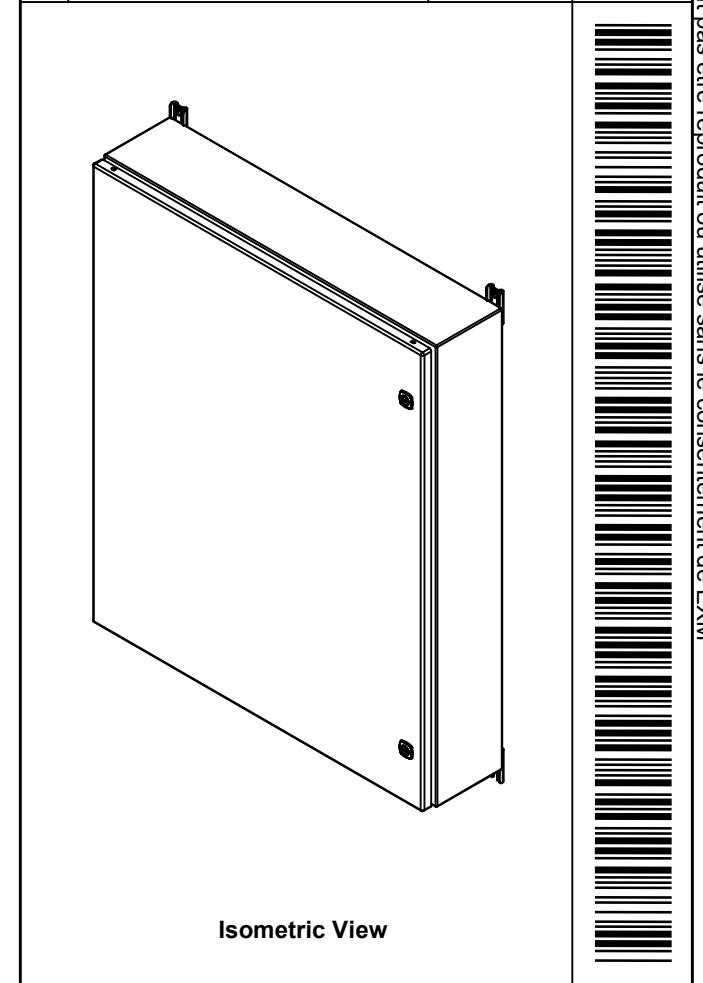

Isometric View

	Flatness Aplatissement Max 3.0mm
	Projection
Customer Client	Date
Drawn By Dessiné Par BoxCad: BoxCad	Date 11-Apr-23
Material Matière 14 Ga Cold Rolled A1008 CS Type B (1.7mm)	
Color Couleur Asa-61 Grey	Finish Fini Smooth
Description 5412ESBU 36" x 30" x 6" Assembly	
Detail Rev.	
Part Number Numéro Pièce 5412ESBU363006TH	Rev. 0

SEE BILL OF MATERIAL ON LAST PAGE

This drawing is confidential and must not be reproduced or used without the consent of EXM

Ce dessin est confidentiel et ne doit pas être reproduit ou utilisé sans le consentement de EXM

NOTE	
ITEM	DESCRIPTION
1	NEMA 4/12 Enclosure
2	C/W Standard ground studs on box and cover
3	C/W Standard door stiffener
4	C/W Standard inner panel (Included)
5	C/W Standard inner panel mounting studs
6	C/W 885 ESMF3_OPEN Sold separately (Installed)
7	C/W 885 ESMF3_CLOSE Sold separately (Installed)
8	C/W R5 Insulation (Installed by EXM)

No.	Revisions	Date	By/Par

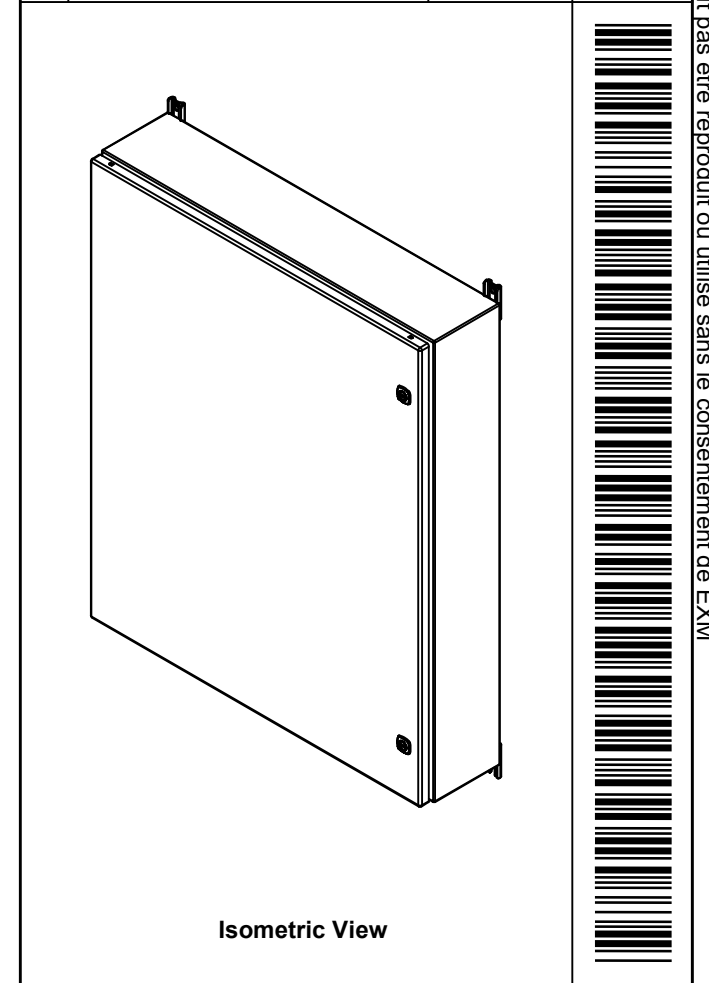

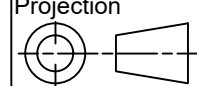
 Tél: (450) 979-4373 Fax: (450) 979-4626 www.exmweb.com	Flatness Aplatissement
	Max 3.0mm
Projection	
Customer Client	Date
Drawn By Dessiné Par BoxCad: BoxCad	Date 11-Apr-23
Material Matière 14 Ga Cold Rolled A1008 CS Type B (1.7mm)	

PACKING		
ITEM	QTY	DESCRIPTION
Cardboard sleeve	2	Top and Bottom
Cardboard strip	2	Between back of enclosure and inner panel
Plastic bag	1	To protect cover surface and inside gasket
Plastic strap - Black	2	To Squeeze the 2 cardboard sleeve together
Packaging label	1	White label with product number

6	STK-Q-00600	2	M12 to M8 Adaptor
1	881 SP3630G	0	881 SP - Inner Panel
1	STK-K-01800	5	5412 ES Accessory Kit
1	5412ESBU363006THC	0	5412ESBU 36" x 30" Cover
1	5412ESBU363006THB	0	5412ESBU 36" x 30" x 6" Body
6	STK-Q-04050-08	0	M6 x 8mm Hexagon Socket Head Machine Screw
Qty	Part Number	Rev	Description
Parts List			

Color Couleur	Asa-61 Grey	Finish Fini	Smooth
Description	5412ESBU 36" x 30" x 6" Assembly		
Part Number Numéro Pièce	5412ESBU363006TH		Rev. 2
			0
			16

This drawing is confidential and must not be reproduced or used without the consent of EXM

Ce dessin est confidentiel et ne doit pas être reproduit ou utilisé sans le consentement de EXM

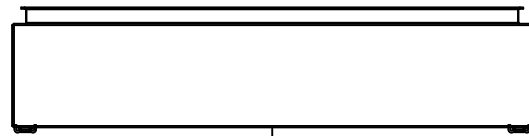

TOP

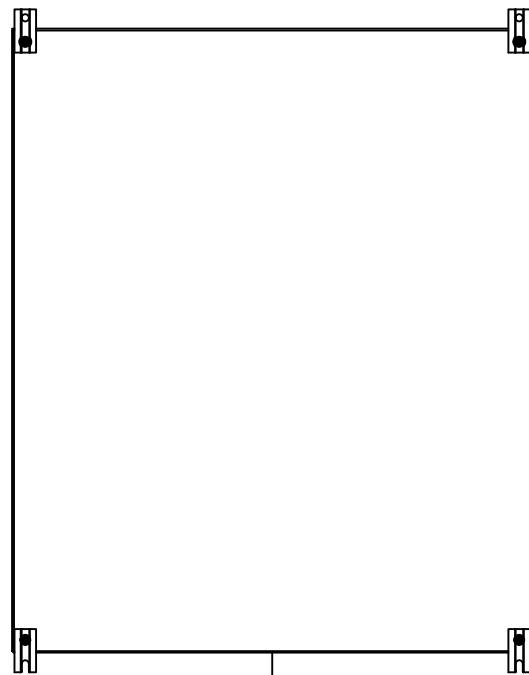

BACK

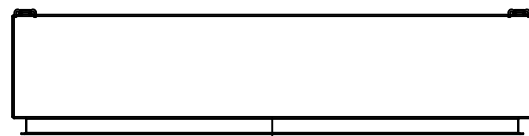

BOTTOM

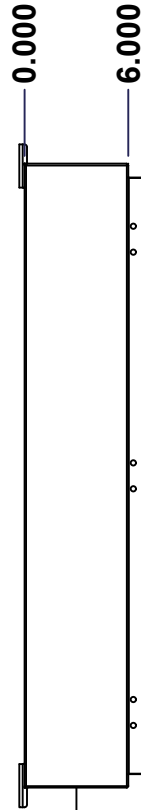

LEFT

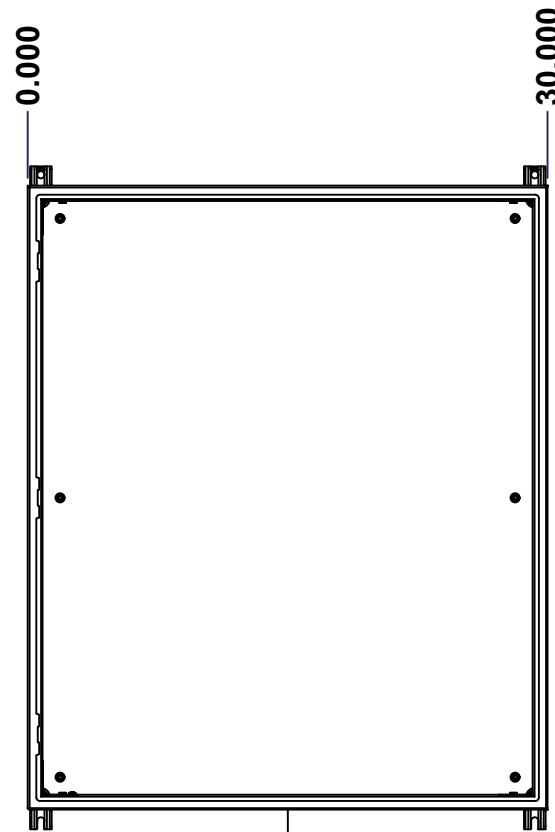

FRONT

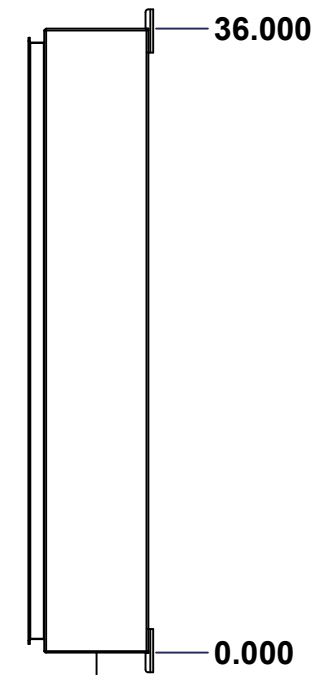

RIGHT

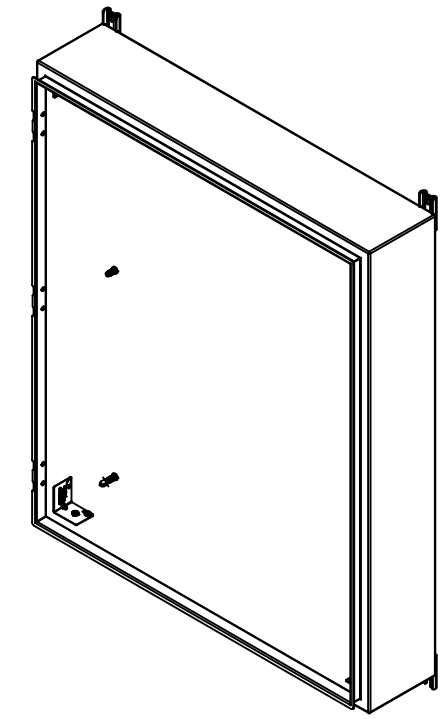

Isometric View

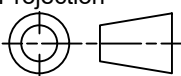

No.	Revisions	Date	By/Par

 Tél: (450) 979-4373 Fax: (450) 979-4626 www.exmweb.com		Flatness Aplatissement Max 3.0mm Projection 
Customer Client	Date	
Drawn By Dessiné Par	BoxCad: BoxCad	Date 11-Apr-23
Material Matière	14 Ga Cold Rolled A1008 CS Type B (1.7mm)	
Color Couleur	Asa-61 Grey	Finish Fini Smooth
Description	Detail Rev.	
5412ESBU 36" x 30" x 6" Body		
Part Number Numéro Pièce	Rev. 0	3 / 16

SEE BILL OF MATERIAL ON LAST PAGE

5412ESBU363006THB

This drawing is confidential and must not be reproduced or used without the consent of EXM

Ce dessin est confidentiel et ne doit pas être reproduit ou utilisé sans le consentement de EXM

STANDARD FEATURES ARE NOT LISTED IN THIS HOLE TABLE			
HOLE TABLE - TOP VIEW (CUSTOM FEATURE ONLY)			
CUT-OUT	XDIM	YDIM	DESCRIPTION
1	2.000	4.500	INSUL. STUD M6 x 18mm (Inside)
2	28.000	4.500	INSUL. STUD M6 x 18mm (Inside)

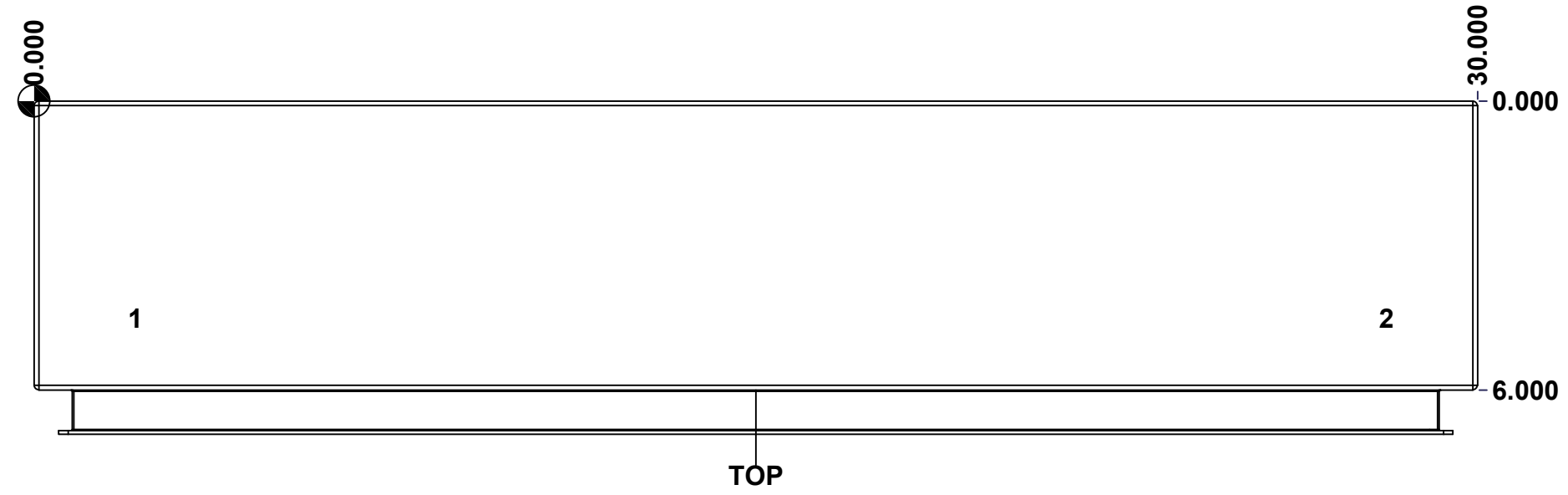

	Description	Status
	5412ESBU 36" x 30" x 6" Body	(NULL)
	Part Number Numéro Pièce	Rev.
	5412ESBU363006THB	0
		4
		16

This drawing is confidential and must not be reproduced or used without the consent of EXM

Ce dessin est confidentiel et ne doit pas être reproduit ou utilisé sans le consentement de EXM

STANDARD FEATURES ARE NOT LISTED IN THIS HOLE TABLE			
HOLE TABLE - BOTTOM VIEW (CUSTOM FEATURE ONLY)			
CUT-OUT	XDIM	YDIM	DESCRIPTION
1	2.000	4.500	INSUL. STUD M6 x 18mm (Inside)
2	28.000	4.500	INSUL. STUD M6 x 18mm (Inside)

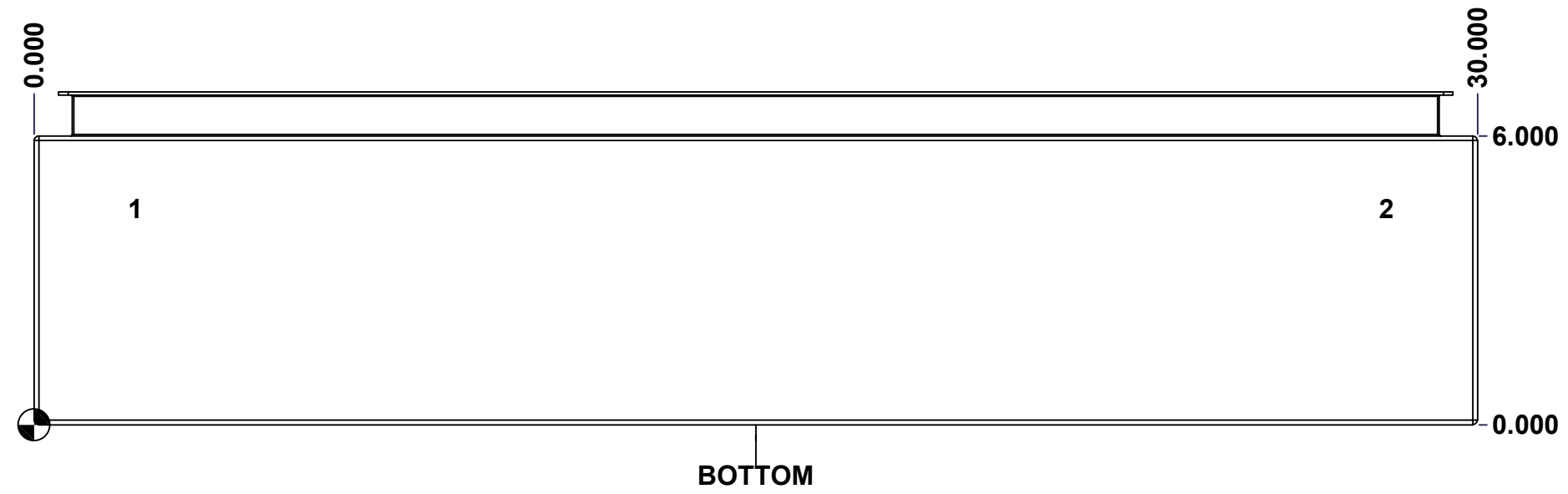

	Description	Status
	5412ESBU 36" x 30" x 6" Body	(NULL)
	Part Number Numéro Pièce	Rev.
	5412ESBU363006THB	0 / 5
		16

This drawing is confidential and must not be reproduced or used without the consent of EXM

Ce dessin est confidentiel et ne doit pas être reproduit ou utilisé sans le consentement de EXM

STANDARD FEATURES ARE NOT LISTED IN THIS HOLE TABLE

HOLE TABLE - BACK VIEW (CUSTOM FEATURE ONLY)

CUT-OUT	XDIM	YDIM	DESCRIPTION
1	1.875	1.875	IP STUD M8 x 35mm (Inside)
2	1.875	34.125	IP STUD M8 x 35mm (Inside)
3	28.125	34.125	IP STUD M8 x 35mm (Inside)
4	28.125	1.875	IP STUD M8 x 35mm (Inside)
5	1.875	18.000	IP STUD M8 x 35mm (Inside)
6	28.125	18.000	IP STUD M8 x 35mm (Inside)

7	29.250	0.000	FOOT 885 ESMF3_OPEN
8	0.750	0.000	FOOT 885 ESMF3_OPEN
9	29.250	36.000	FOOT 885 ESMF3_CLOSE
10	0.750	36.000	FOOT 885 ESMF3_CLOSE

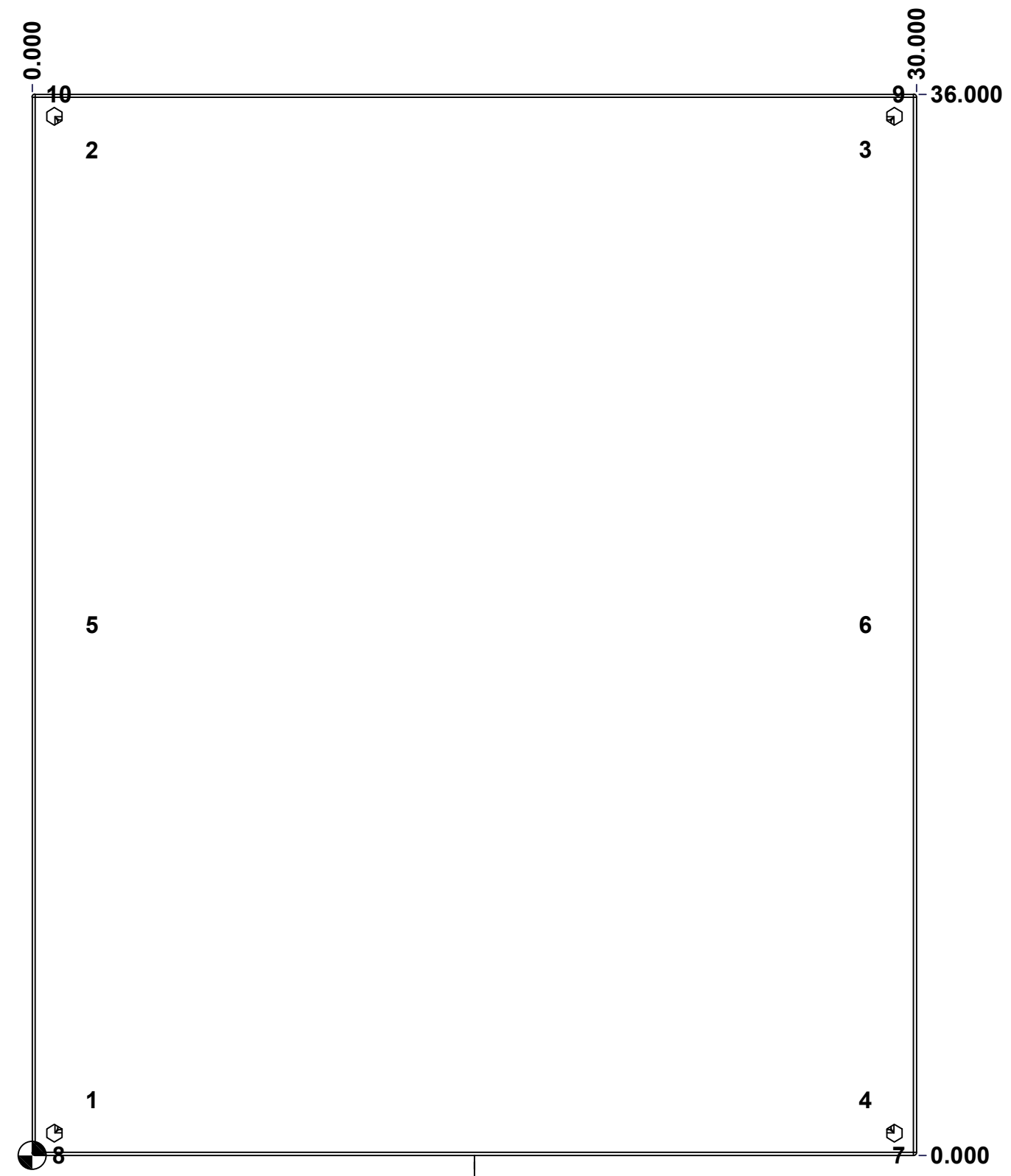

BACK

	Description	Status
	5412ESBU 36" x 30" x 6" Body	(NULL)
	Part Number Numéro Pièce	Rev.
	5412ESBU363006THB	0 / 6
		16

This drawing is confidential and must not be reproduced or used without the consent of EXM

Ce dessin est confidentiel et ne doit pas être reproduit ou utilisé sans le consentement de EXM

No.	Revisions	Date	By/Par

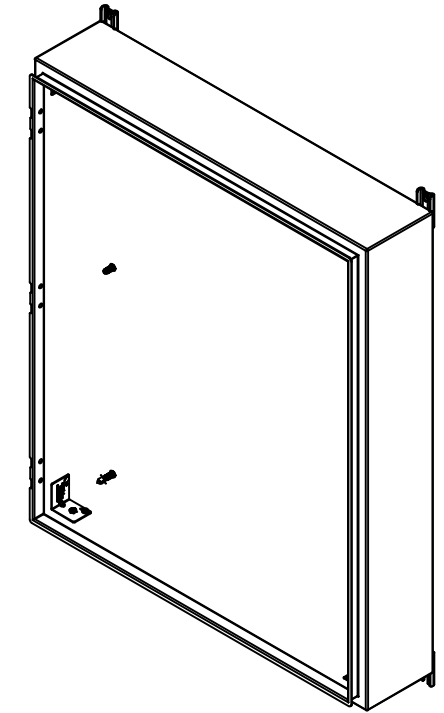

Isometric View



2	885ESMF3-FEET	0	885 ESMF3 Mounting Foot
4	RIVET_NUT_M10_FH_CE	0	Rivet Nut M10 (Low Profile Close End)
4	STK-Q-06660	2	M10 x 16mm Machine Screw
2	885ESMF3-FEET-A	0	885 ESMF3 Mounting Foot (Opened Slot)
1	STK-K-70554	3	5412 ESTH Accessory Kit
1	5412ESBU363006THI-RS	0	5412ESBU 36" x 30" Right Insulation
1	5412ESBU363006THI-LS	0	5412ESBU 36" x 30" Left Insulation
1	5412ESBU363006THI-BT	0	5412ESBU 36" x 30" Top and Bottom Insulation
1	5412ESBU363006THI-TP	0	5412ESBU 36" x 30" Top and Bottom Insulation
1	5412ESBU363006THI-B	0	5412ESBU 36" x 30" Back Insulation
4	STK-Q-16055	1	M6 x 18mm Stud (No Paint Cap Required)
1	STK-P-02400S	0	Powder Paint (Asa-61 Grey / Smooth)
6	STK-Q-16005	1	Stud M8 x 35 (No Paint Cap Required)
1	5412ESBU363006THB-P	0	5412ESBU 36" x 30" x 6" Body Part

Qty	Part Number	Rev	Description
Parts List			

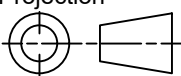
 Tél: (450) 979-4373 Fax: (450) 979-4626 www.exmweb.com		Flatness Aplatissement Max 3.0mm
Projection 		Date 11-Apr-23
Customer Client	BoxCad: BoxCad	Date
Drawn By Dessiné Par	14 Ga Cold Rolled A1008 CS Type B (1.7mm)	Date
Material Matière	Color Couleur	Finish Fini
	Asa-61 Grey	Smooth
Description 5412ESBU 36" x 30" x 6" Body		Detail Rev.
Part Number Numéro Pièce		Rev.
5412ESBU363006THB		0
		7
		16

This drawing is confidential and must not be reproduced or used without the consent of EXM

Ce dessin est confidentiel et ne doit pas être reproduit ou utilisé sans le consentement de EXM

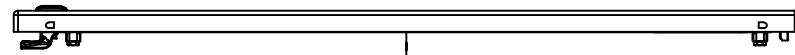

TOP

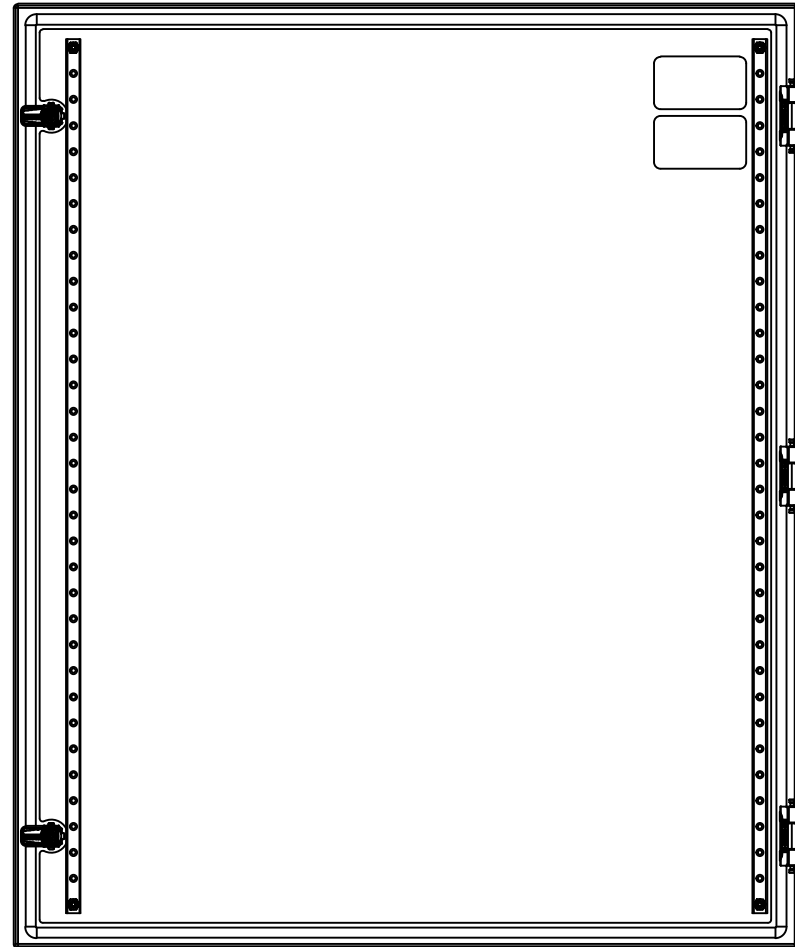

BACK

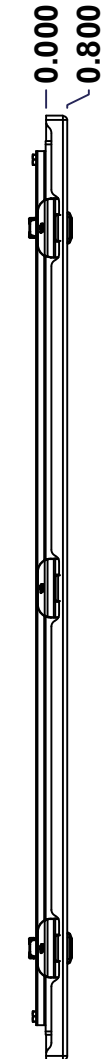

LEFT

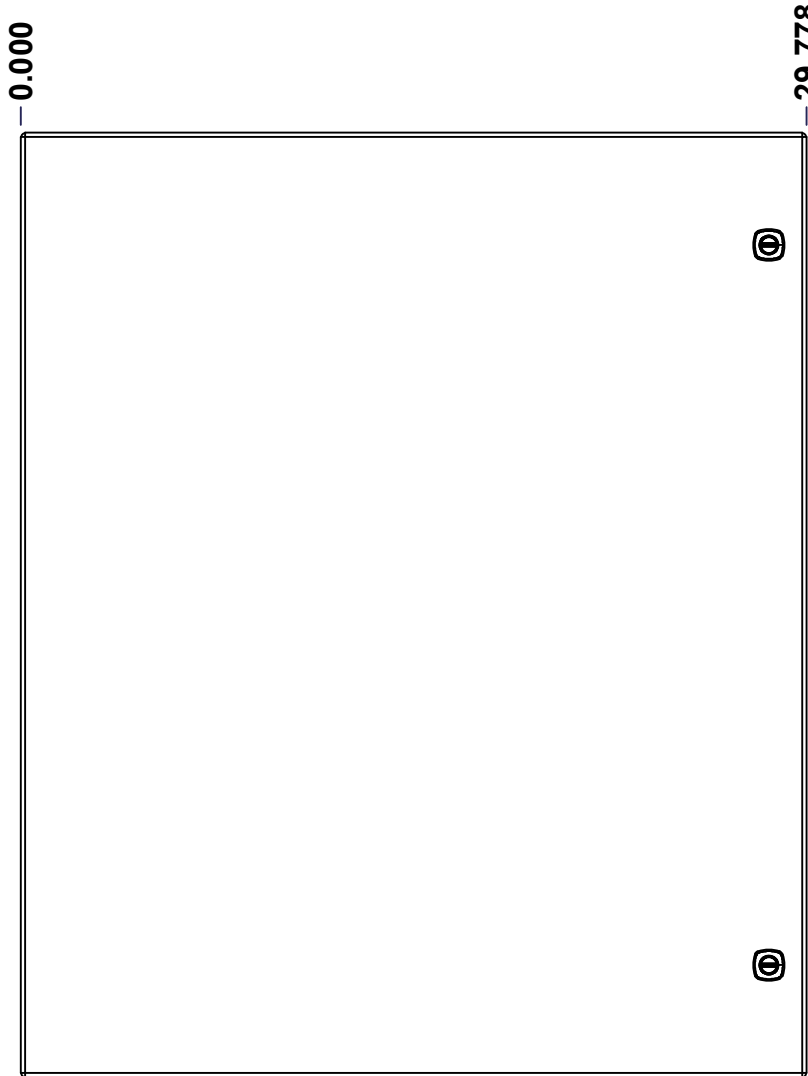

FRONT

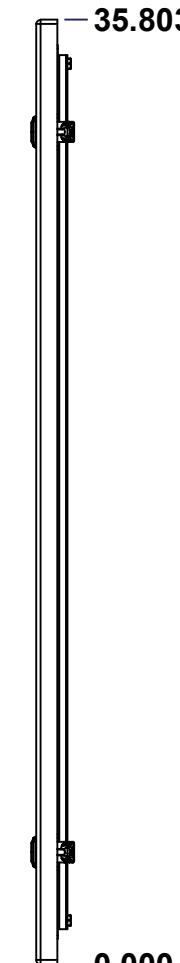

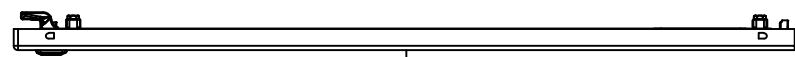

RIGHT

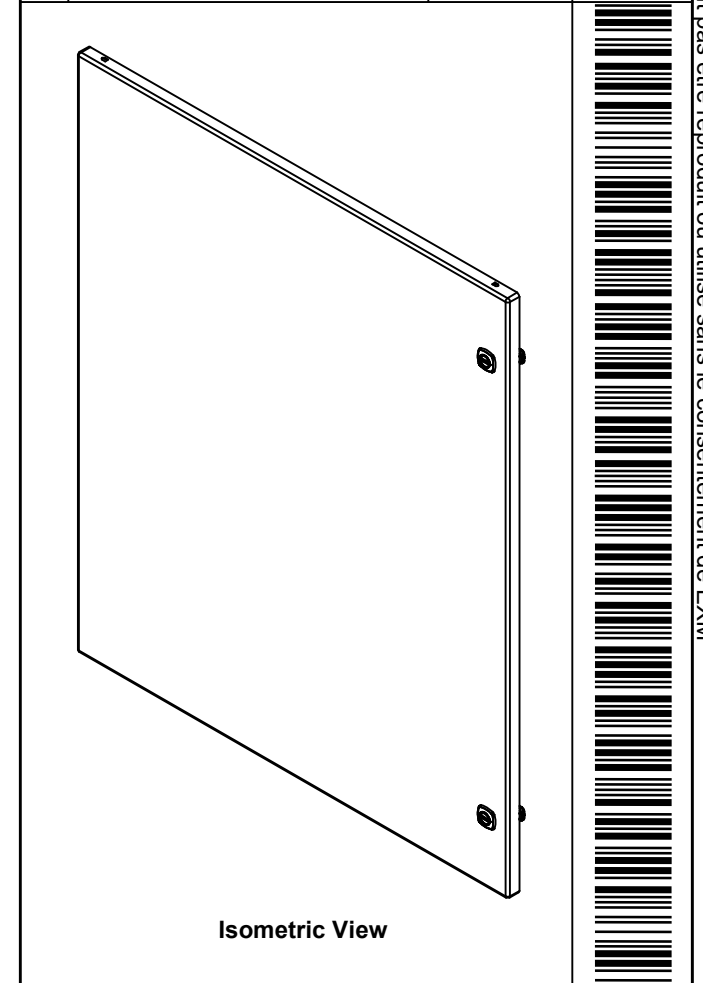

BOTTOM

No.	Revisions	Date	By/Par

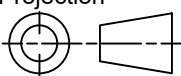

 Tél: (450) 979-4373 Fax: (450) 979-4626 www.exmweb.com	Flatness Aplatissement	Max 3.0mm
	Projection	
Customer Client	Date	
Drawn By Dessiné Par	BoxCad: BoxCad	Date 11-Apr-23
Material Matière	14 Ga Cold Rolled A1008 CS Type B (1.7mm)	
Color Couleur	Asa-61 Grey	Finish Fini Smooth
Description	Detail Rev.	
5412ESBU 36" x 30" Cover		
Part Number Numéro Pièce	Rev. 0	8 / 16

SEE BILL OF MATERIAL ON LAST PAGE

5412ESBU363006THC

This drawing is confidential and must not be reproduced or used without the consent of EXM

Ce dessin est confidentiel et ne doit pas être reproduit ou utilisé sans le consentement de EXM

STANDARD FEATURES ARE NOT LISTED IN THIS HOLE TABLE

HOLE TABLE - FRONT VIEW (CUSTOM FEATURE ONLY)

CUT-OUT	XDIM	YDIM	DESCRIPTION
1	1.486	1.661	STUD M6 x 18mm (Inside)
2	1.486	34.142	STUD M6 x 18mm (Inside)
3	27.517	34.142	STUD M6 x 18mm (Inside)
4	27.517	1.661	STUD M6 x 18mm (Inside)

5	28.354	31.553	880 SCQ4-SL
6	28.354	4.250	880 SCQ4-SL

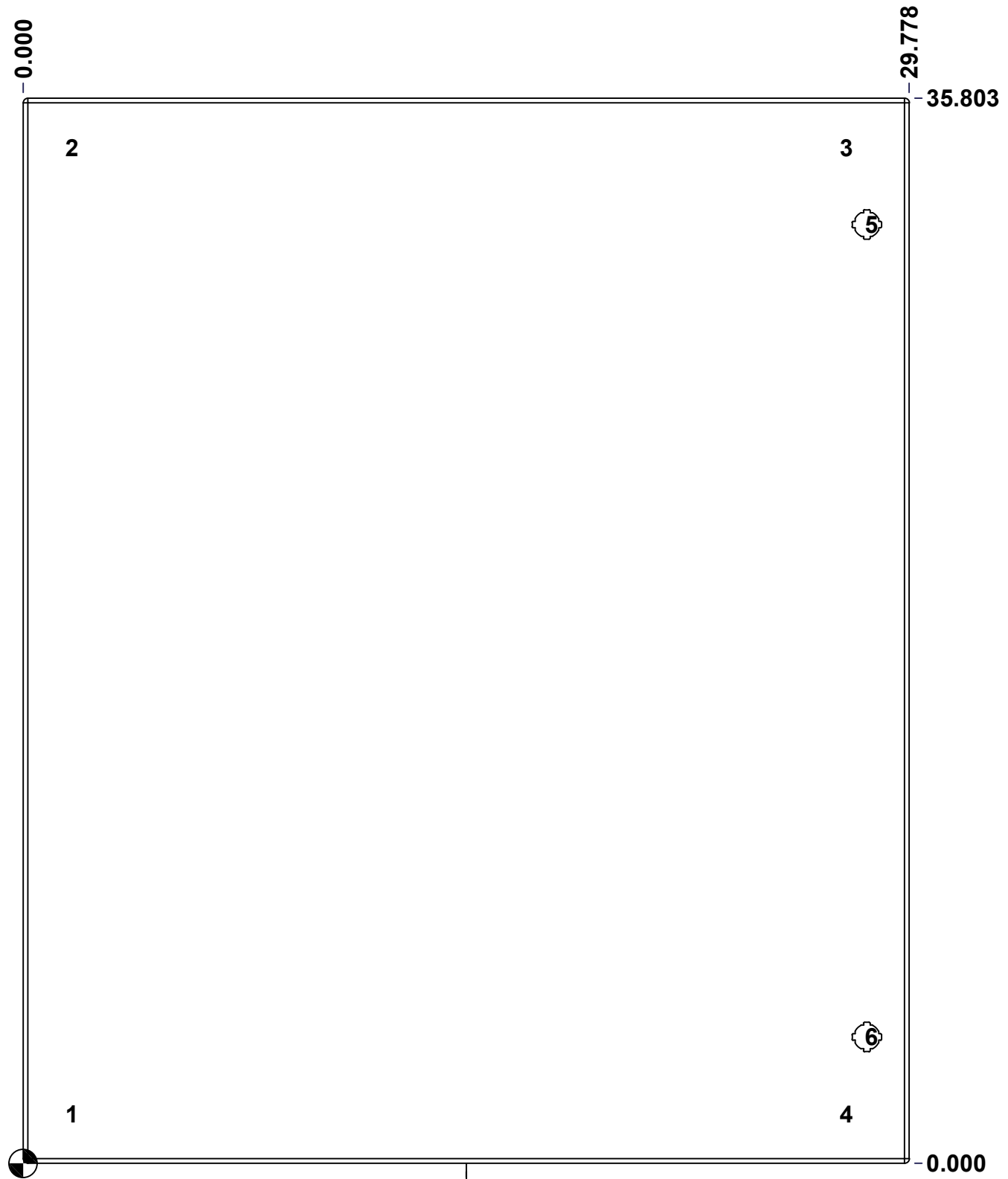

FRONT

	Description	Status
	5412ESBU 36" x 30" Cover	(NULL)
	Part Number Numéro Pièce	Rev.
	5412ESBU363006THC	0 / 9
		16

This drawing is confidential and must not be reproduced or used without the consent of EXM

Ce dessin est confidentiel et ne doit pas être reproduit ou utilisé sans le consentement de EXM

No.	Revisions	Date	By/Par

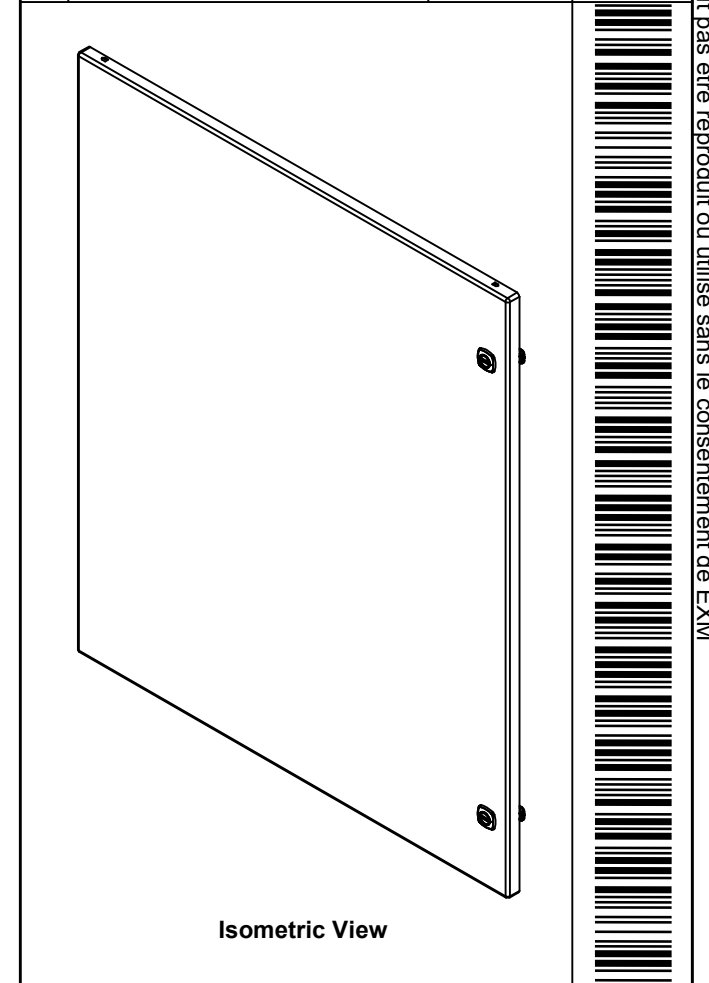

Isometric View

 Tél: (450) 979-4373
 Fax: (450) 979-4626
www.exmweb.com

Flatness
 Aplatissement
 Max 3.0mm
 Projection

2	STK-S-00100	0	3.5" x 2" Silver Milar Flexcon Sticker
4	STK-Q-07250	2	M6 x 16mm Collar Nut
2	STK-Q-46020-36	5	5412 ES Vertical Door Stiffener 36"
1	5412ESBU363006THI-C	0	5412ESBU 36" x 30" Cover Insulation
1	STK-P-02400S	0	Powder Paint (Asa-61 Grey / Smooth)
4	STK-Q-16055	1	M6 x 18mm Stud (No Paint Cap Required)
3	STK-A-33005	4	5412 ESBU Hinge 180° (Body Part)
1	5412ESBU363006THG	0	5412ESBU 36" x 30" Cover Gasket Part
1	5412ESBU363006THC-P	0	5412ESBU 36" x 30" Cover Part
2	STK-K-12500	16	5412 ES 1/4 Turn Lock
QTY	Part Number	Rev	Description
Parts List			

Customer Client	Date
Drawn By Dessiné Par	Date 11-Apr-23
Material Matière	BoxCad: BoxCad
Color Couleur	14 Ga Cold Rolled A1008 CS Type B (1.7mm)
Asa-61 Grey	Finish Fini
Smooth	Detail Rev.
Description	5412ESBU 36" x 30" Cover
Part Number Numéro Pièce	Rev. 10
5412ESBU363006THC	0 16

This drawing is confidential and must not be reproduced or used without the consent of EXM

Ce dessin est confidentiel et ne doit pas être reproduit ou utilisé sans le consentement de EXM

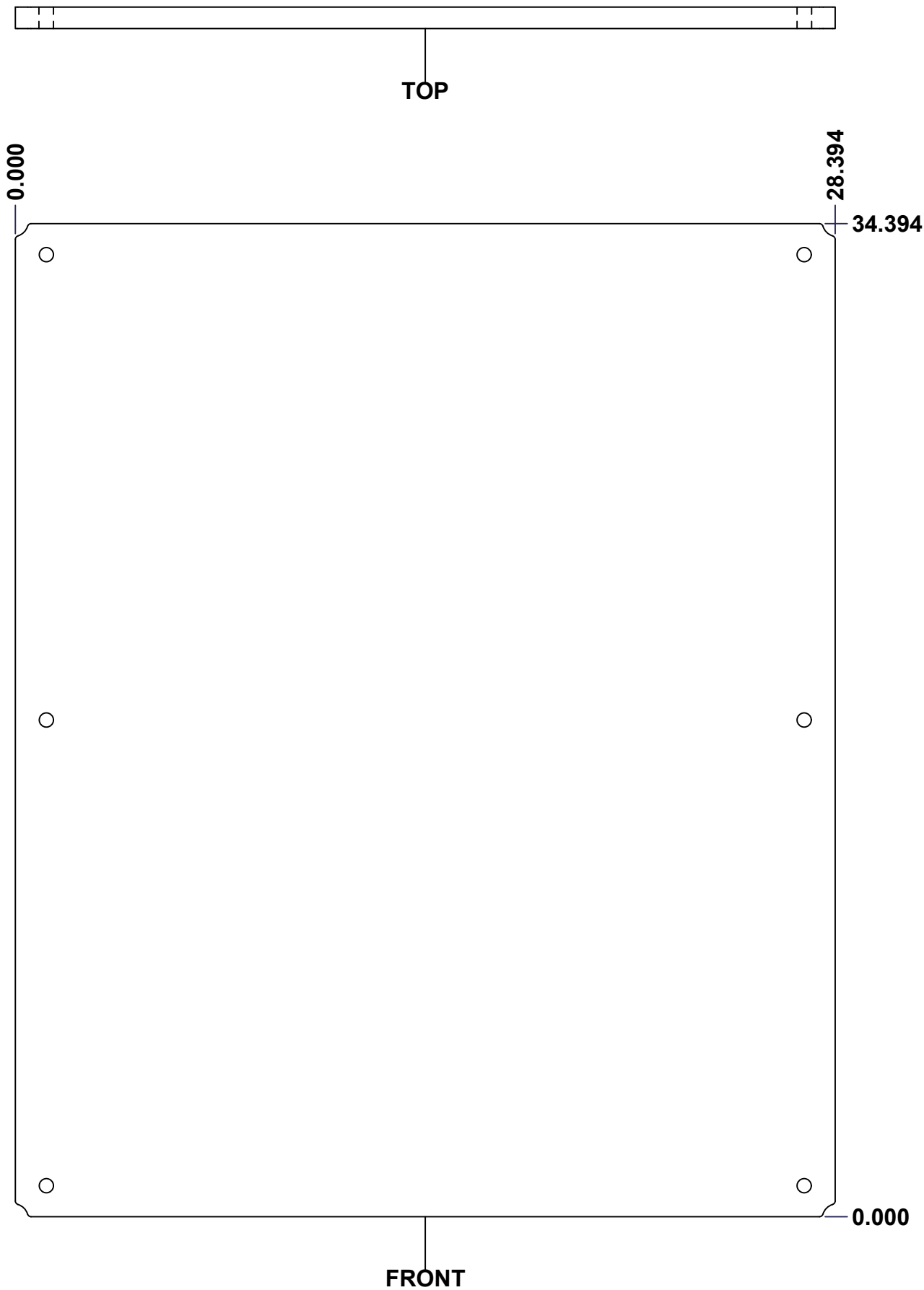

No.	Revisions	Date	By/Par

Isometric View

<p>Tél: (450) 979-4373 Fax: (450) 979-4626 www.exmweb.com</p>		Flatness Aplatissement	
		Max 3.0mm	
Customer Client		Date	
Drawn By Dessiné Par		Date	
Material Matière		Polyisocyanurate	
Color Couleur		Aluminum	Finish Fini
Description		Detail Rev.	
5412ESBU 36" x 30" Back Insulation			
Part Number Numéro Pièce		Rev.	
5412ESBU363006THI-B		0	11 16

SEE BILL OF MATERIAL ON LAST PAGE

This drawing is confidential and must not be reproduced or used without the consent of EXM

Ce dessin est confidentiel et ne doit pas être reproduit ou utilisé sans le consentement de EXM

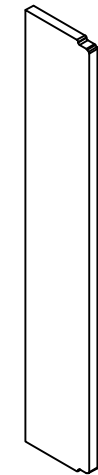
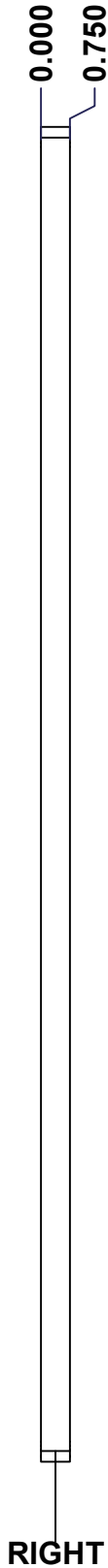
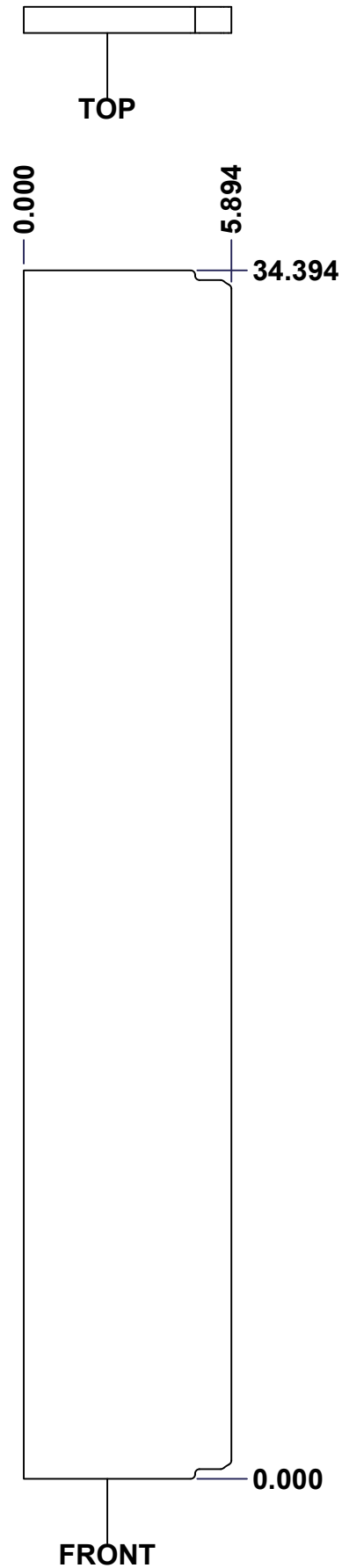

Isometric View



Tél: (450) 979-4373
 Fax: (450) 979-4626
www.exmweb.com

Flatness
Aplatissement

Max 3.0mm

Projection

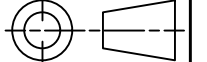

Customer Client	Date
Drawn By Dessiné Par	Date
BoxCad: Patrick Deschenes	23-Jan-07
Material Matière	Polyisocyanurate
Color Couleur	Aluminum
Finish Fini	N/A
Description	Detail Rev.
5412ESBU 36" x 30" Left Insulation	
Part Number Numéro Pièce	Rev.
5412ESBU363006THI-LS	0
	12
	16

SEE BILL OF MATERIAL ON LAST PAGE

This drawing is confidential and must not be reproduced or used without the consent of EXM

Ce dessin est confidentiel et ne doit pas être reproduit ou utilisé sans le consentement de EXM

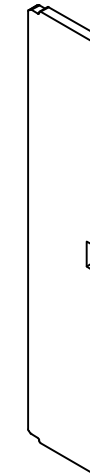
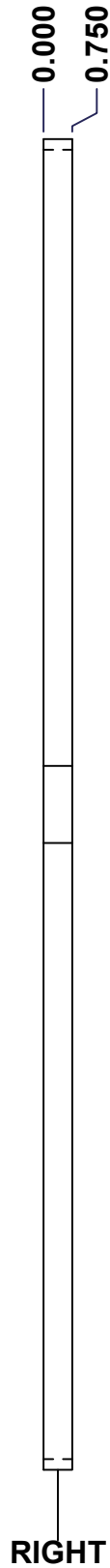
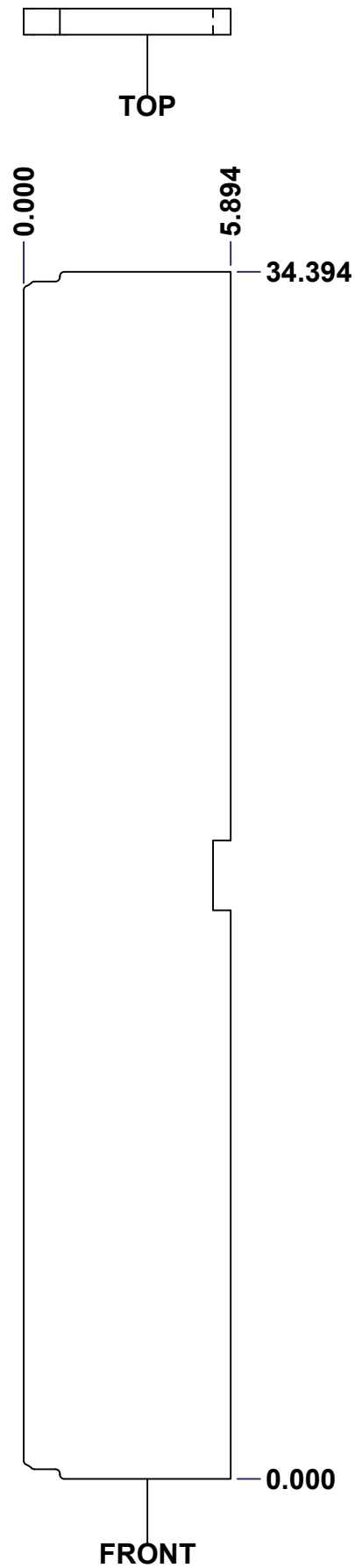

Isometric View



Tél: (450) 979-4373
 Fax: (450) 979-4626
www.exmweb.com

Flatness
Aplatissement

Max 3.0mm

Projection

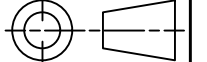

Customer Client	Date
Drawn By Dessiné Par	Date 23-Jan-07
Material Matière	Polyisocyanurate
Color Couleur	Aluminum
Finish Fini	N/A

Description	Detail Rev.
5412ESBU 36" x 30" Right Insulation	

Part Number Numéro Pièce	Rev.	13
5412ESBU363006THI-RS	0	16

SEE BILL OF MATERIAL ON LAST PAGE

This drawing is confidential and must not be reproduced or used without the consent of EXM

Ce dessin est confidentiel et ne doit pas être reproduit ou utilisé sans le consentement de EXM

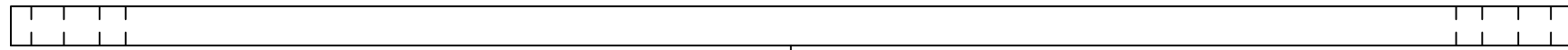

TOP

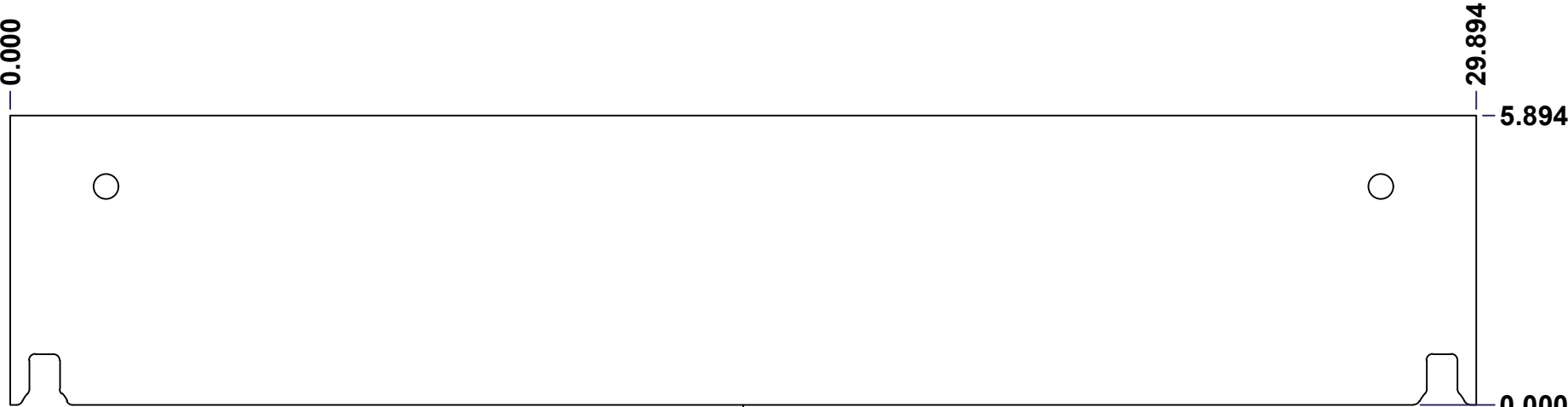

FRONT

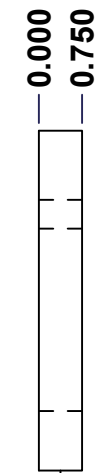

RIGHT

No.	Revisions	Date	By/Par

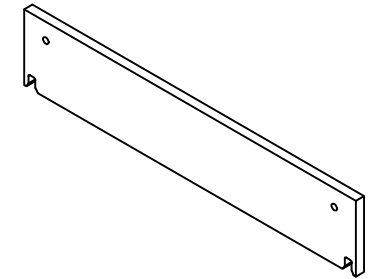

Isometric View



Tél: (450) 979-4373
 Fax: (450) 979-4626
www.exmweb.com

Flatness
Aplatissement

Max 3.0mm

Projection

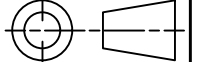

Customer Client	Date
Drawn By / Dessiné Par: BoxCad: Patrick Deschenes	Date: 23-Jan-07
Material / Matière: Polyisocyanurate	
Color / Couleur: Aluminum	Finish / Fini: N/A

Description: 5412ESBU 36" x 30" Top and Bottom Insulation	Detail Rev.
---	-------------

Part Number / Numéro Pièce: 5412ESBU363006THI-TP	Rev. 0	14	16
--	--------	----	----

SEE BILL OF MATERIAL ON LAST PAGE

This drawing is confidential and must not be reproduced or used without the consent of EXM

Ce dessin est confidentiel et ne doit pas être reproduit ou utilisé sans le consentement de EXM

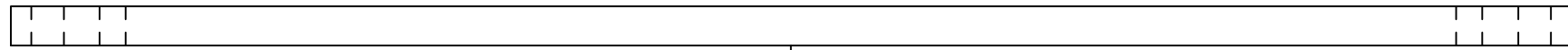

TOP

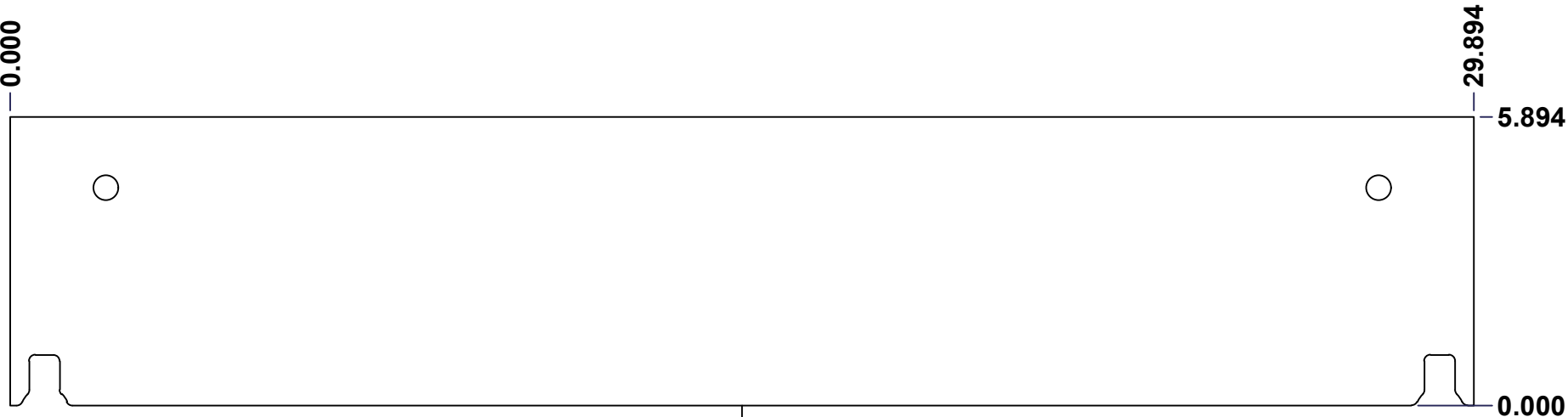

FRONT

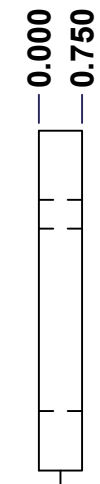

RIGHT

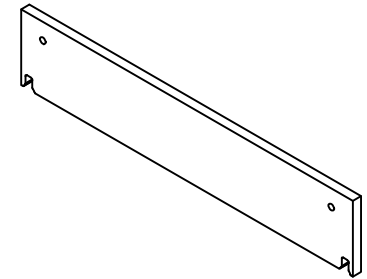

Isometric View

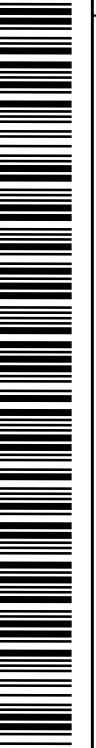

Tél: (450) 979-4373
 Fax: (450) 979-4626
www.exmweb.com

Flatness
Aplatissement

Max 3.0mm

Projection

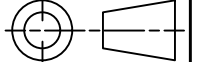

Customer Client	Date
Drawn By / Dessiné Par: BoxCad: Patrick Deschenes	Date: 23-Jan-07
Material / Matière: Polyisocyanurate	
Color / Couleur: Aluminum	Finish / Fini: N/A
Description: 5412ESBU 36" x 30" Top and Bottom Insulation	Detail Rev.
Part Number / Numéro Pièce: 5412ESBU363006THI-BT	Rev. 0

SEE BILL OF MATERIAL ON LAST PAGE

This drawing is confidential and must not be reproduced or used without the consent of EXM

Ce dessin est confidentiel et ne doit pas être reproduit ou utilisé sans le consentement de EXM

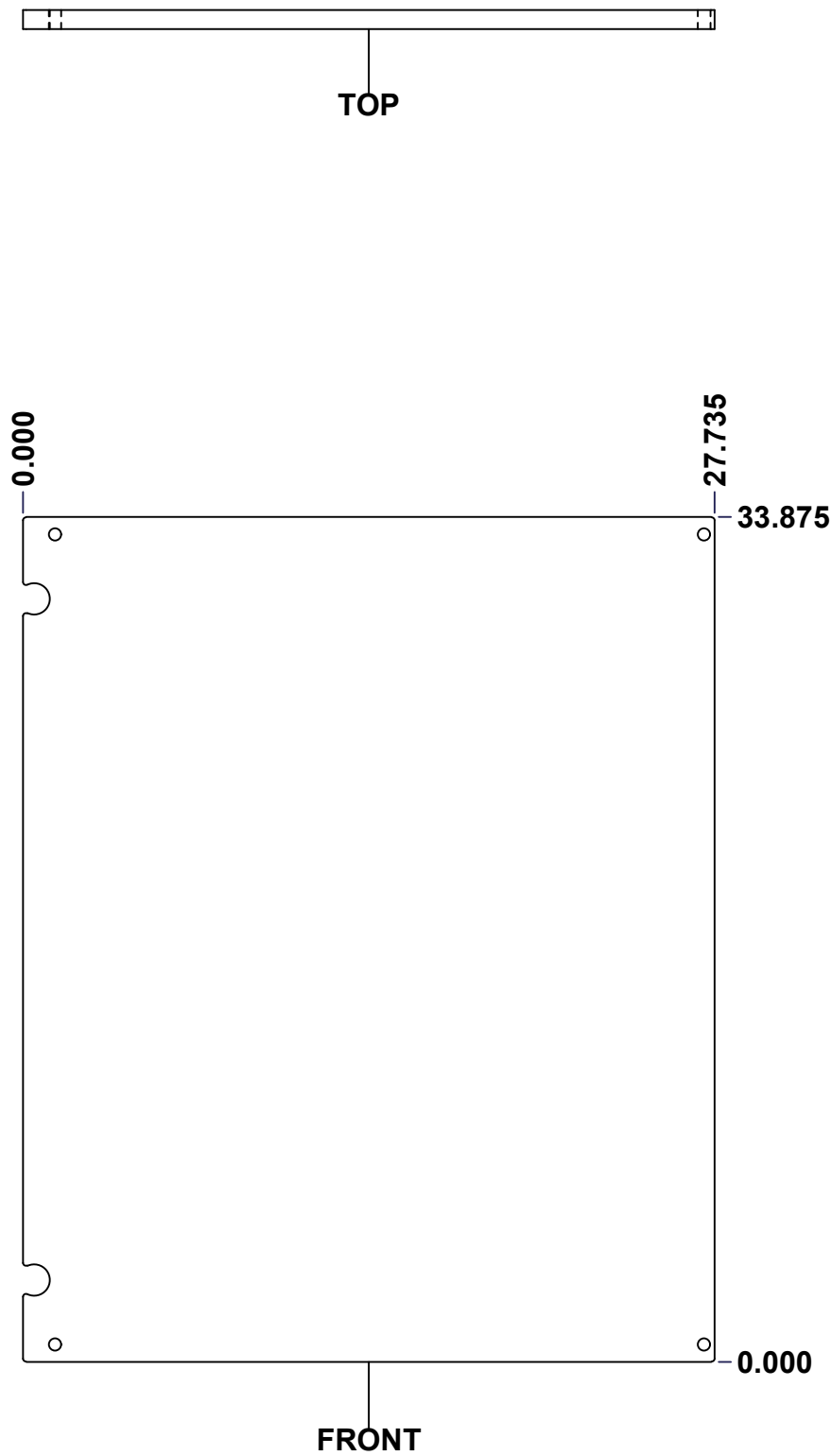

No.	Revisions	Date	By/Par

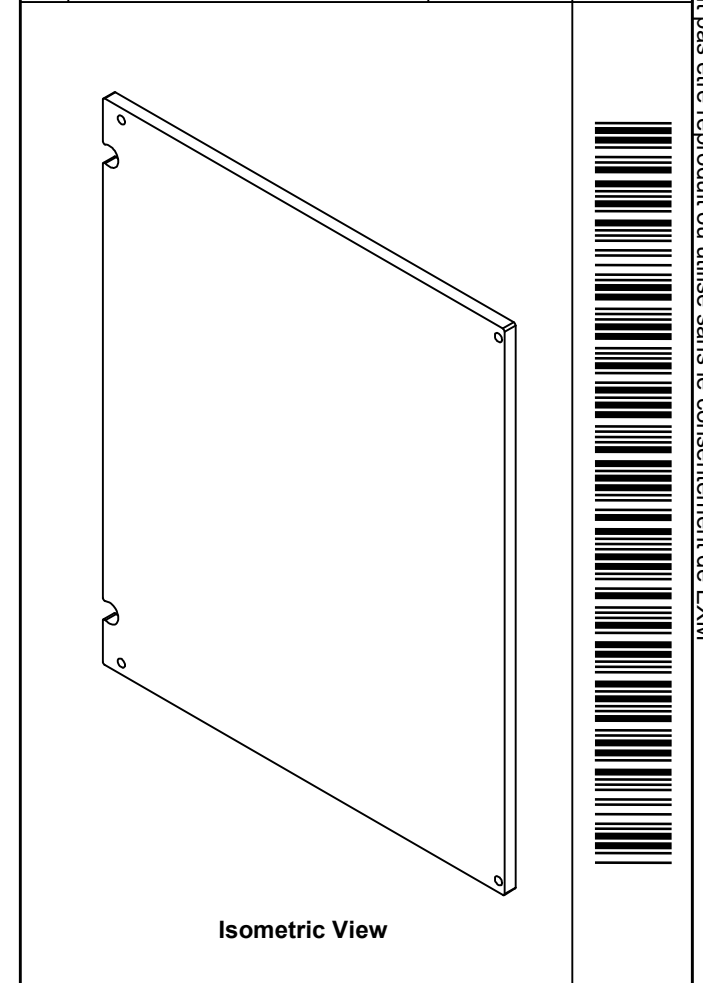

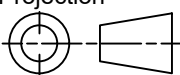
 Tél: (450) 979-4373 Fax: (450) 979-4626 www.exmweb.com		Flatness Aplatissement Max 3.0mm
Customer Client		Projection 
Drawn By Dessiné Par BoxCad: Patrick Deschenes		Date 23-Jan-07
Material Matière Polyisocyanurate		
Color Couleur Aluminum	Finish Fini N/A	
Description 5412ESBU 36" x 30" Cover Insulation		Detail Rev.
Part Number Numéro Pièce 5412ESBU363006THI-C		Rev. 16 0

SEE BILL OF MATERIAL ON LAST PAGE

This drawing is confidential and must not be reproduced or used without the consent of EXM

Ce dessin est confidentiel et ne doit pas être reproduit ou utilisé sans le consentement de EXM

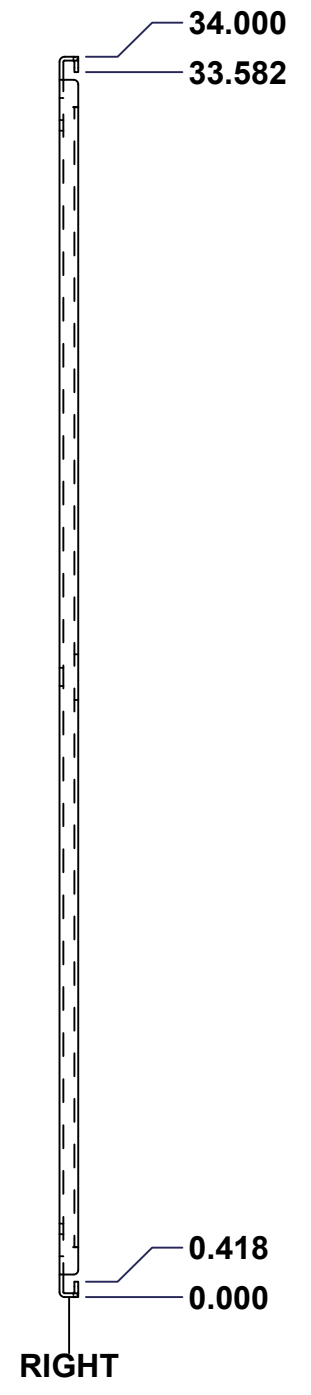
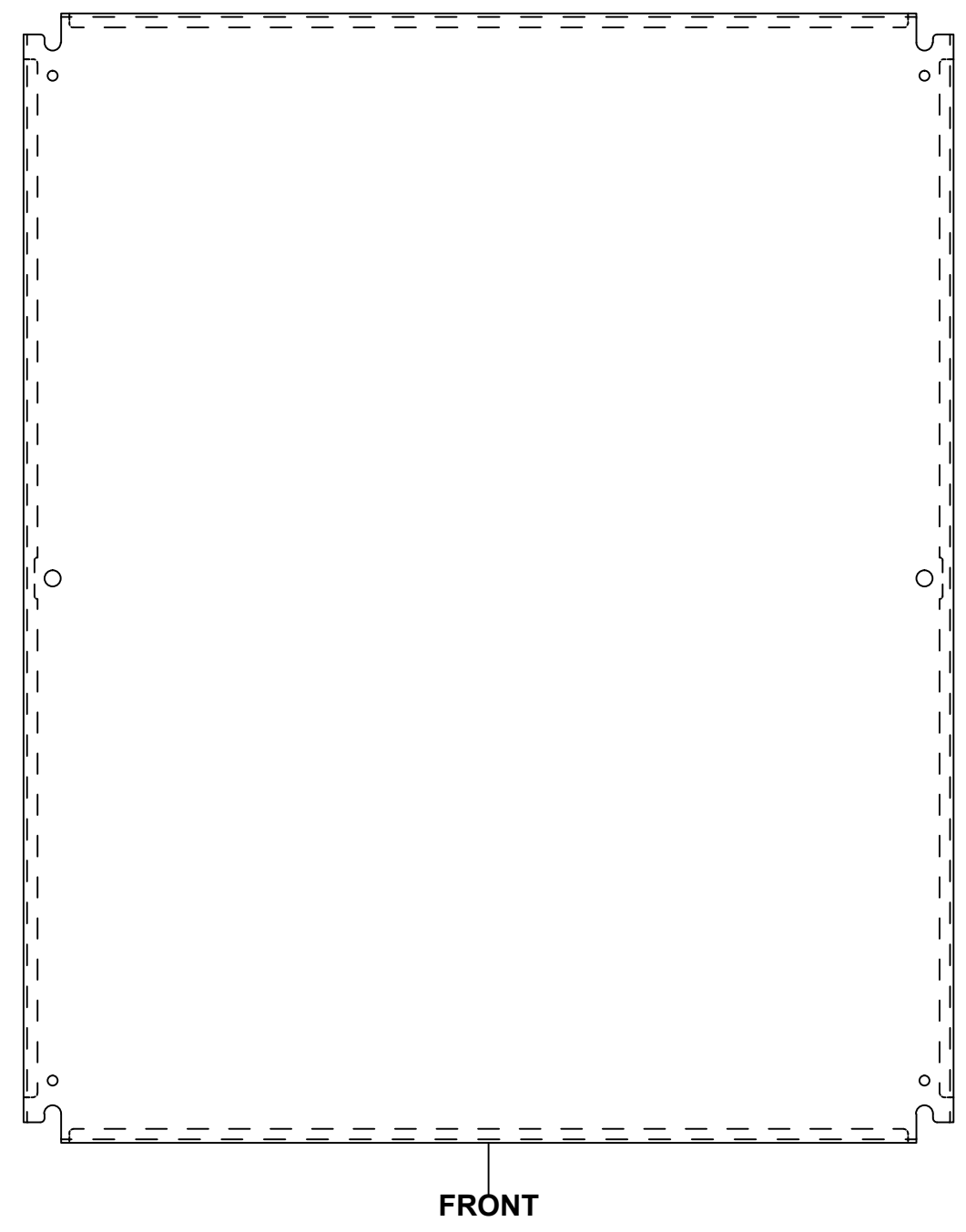
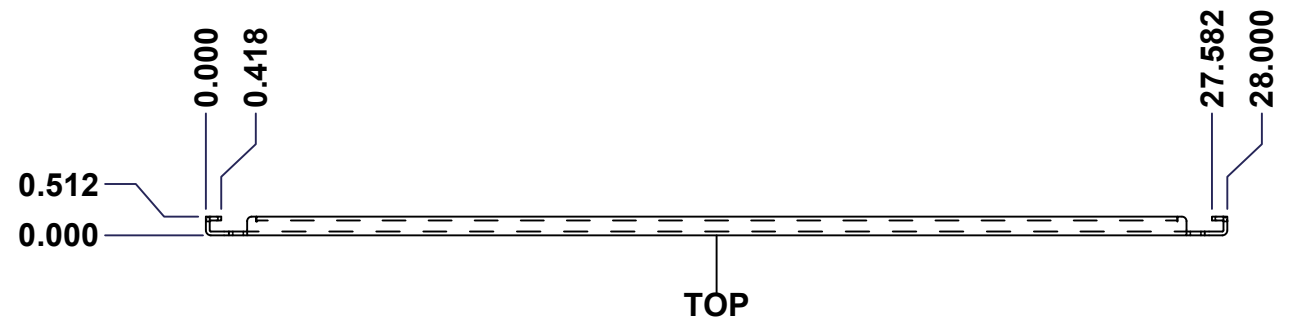

No.	Revisions	Date	By/Par

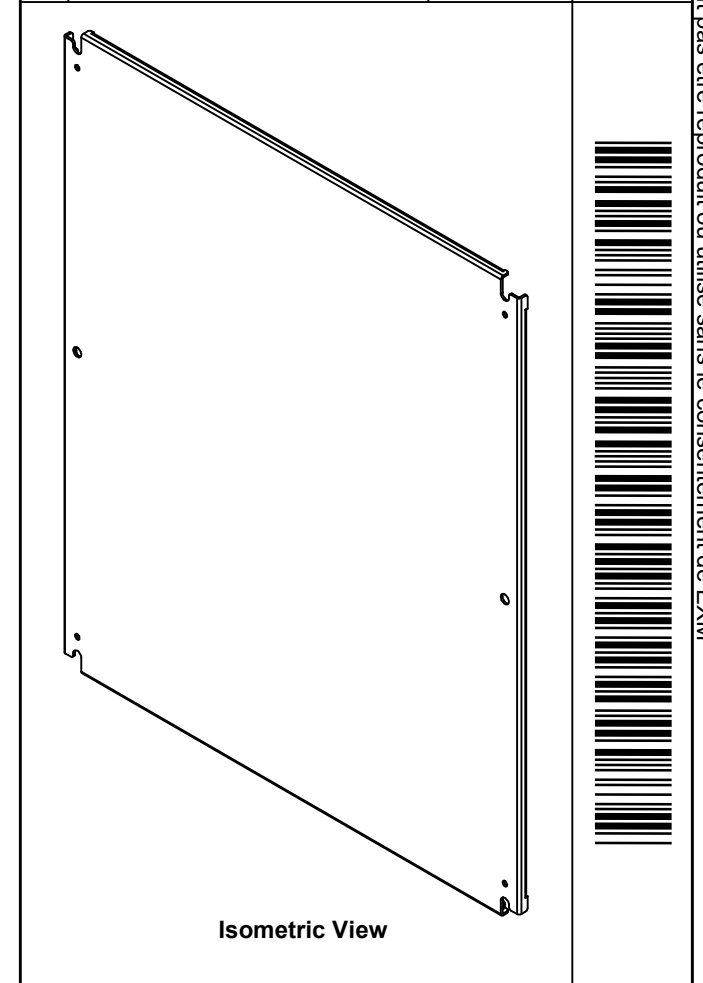

Tél: (450) 979-4373 Fax: (450) 979-4626 www.exmweb.com	Flatness Aplatissement Max 3.0mm
	Projection
Customer Client	Date
Drawn By Dessiné Par: BoxCad	Date: 23-Jan-07
Material Matière	See Part List
Color Couleur	See Part List
Finish Fini	See Part List
Description	Detail Rev.
881 SP - Inner Panel	
Part Number Numéro Pièce: 881 SP3630G	Rev. 1 0

Qty	Part Number	Rev	Description	Material	Color	Finish
1	881 SP3630G-P	0	881 SP - Inner Panel Part	12 Ga Galvanized	Unpainted	Galvanized

Parts List

This drawing is confidential and must not be reproduced or used without the consent of EXM

Ce dessin est confidentiel et ne doit pas être reproduit ou utilisé sans le consentement de EXM

Table 1			FRONT VIEW
CUT-OUT	XDIM	YDIM	DESCRIPTION
1	0.875	1.875	GROUND HOLE (RND Ø0.290)
2	27.125	1.875	GROUND HOLE (RND Ø0.290)
3	0.875	32.125	GROUND HOLE (RND Ø0.290)
4	27.125	32.125	GROUND HOLE (RND Ø0.290)
5	0.875	17.000	MTG STUD HOLE (RND Ø0.500)
6	27.125	17.000	MTG STUD HOLE (RND Ø0.500)

All knockouts are actual size / Les disques défonçables sont grandeur réel

No.	Revisions	Date	By/Par

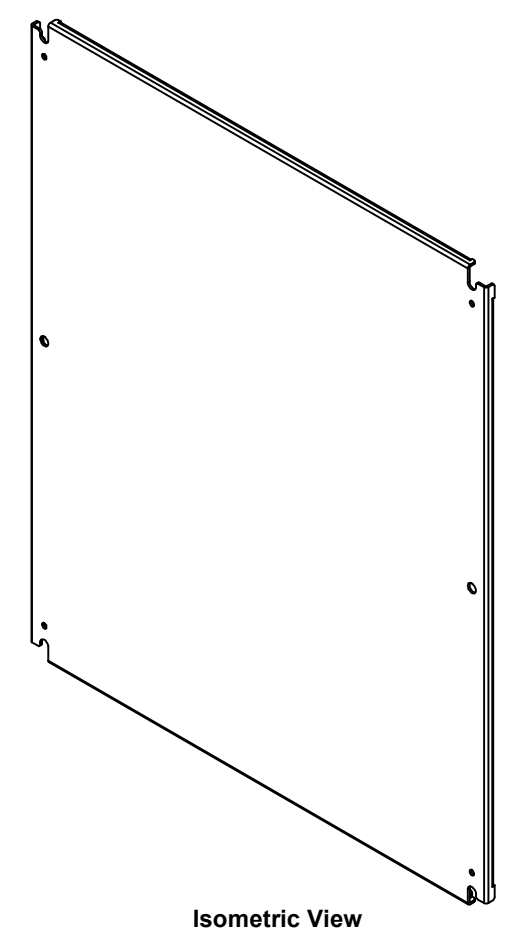
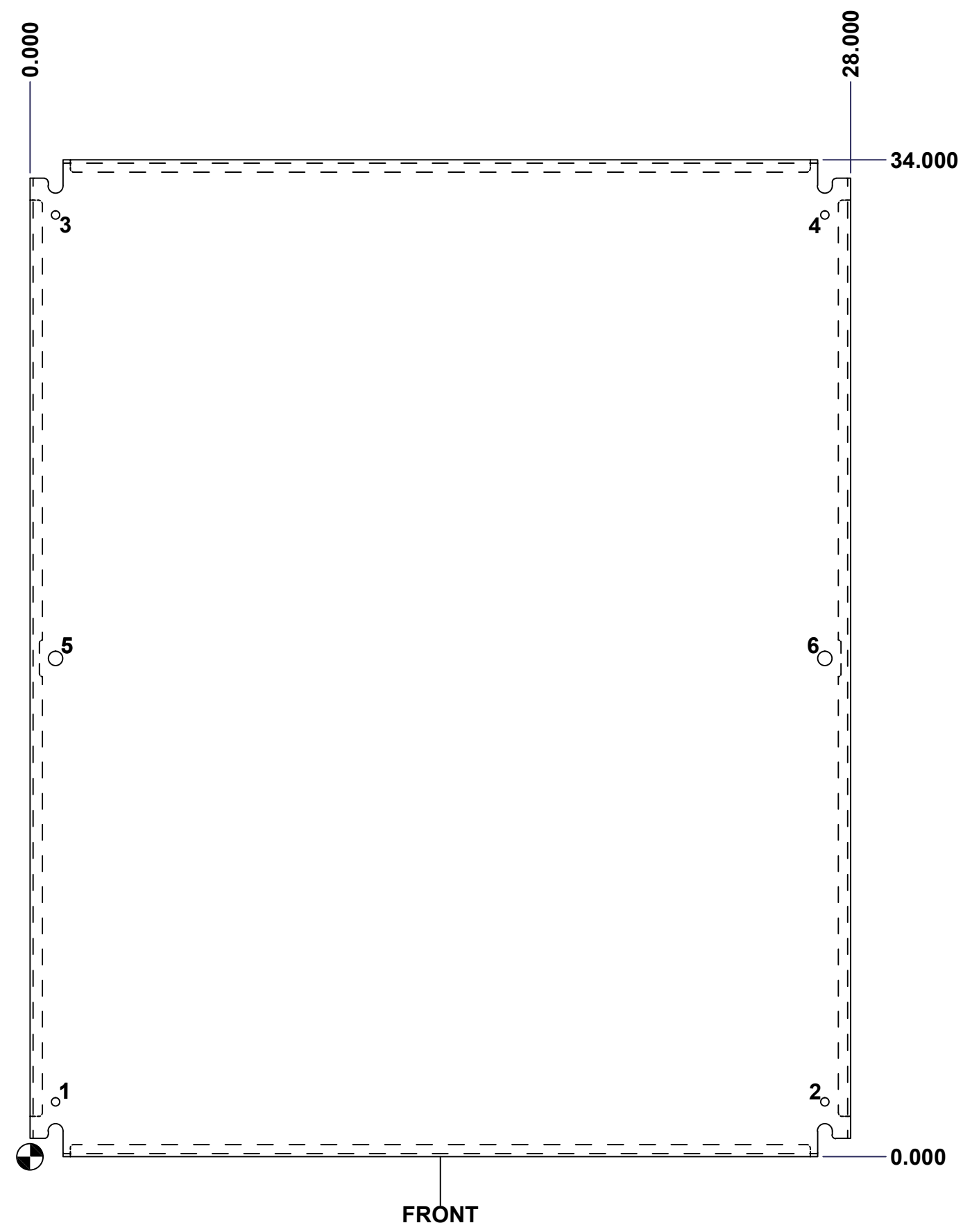

	Tél: (450) 979-4373 Fax: (450) 979-4626 www.exmweb.com	Flatness Aplatissement Max 3.0mm
		Projection
Customer Client		Date
Drawn By Dessiné Par	BoxCad	Date 23-Jan-07
Material Matière	See Part List	
Color Couleur	See Part List	Finish Fini See Part List
Description 881 SP - Inner Panel		Detail Rev.
Part Number Numéro Pièce	881 SP3630G	Rev. 2 0