

This drawing is confidential and must not be reproduced or used without the consent of EXM

Ce dessin est confidentiel et ne doit pas être reproduit ou utilisé sans le consentement de EXM

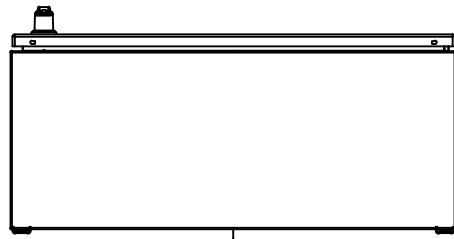

TOP

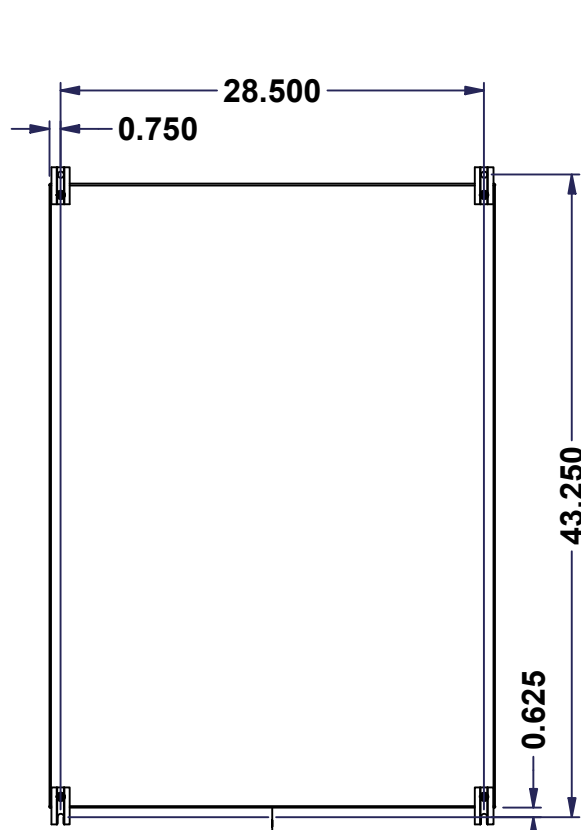

BACK

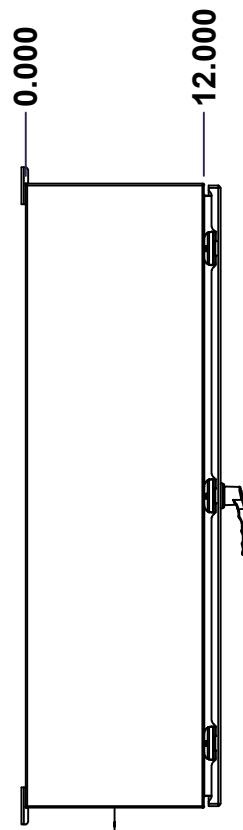

LEFT

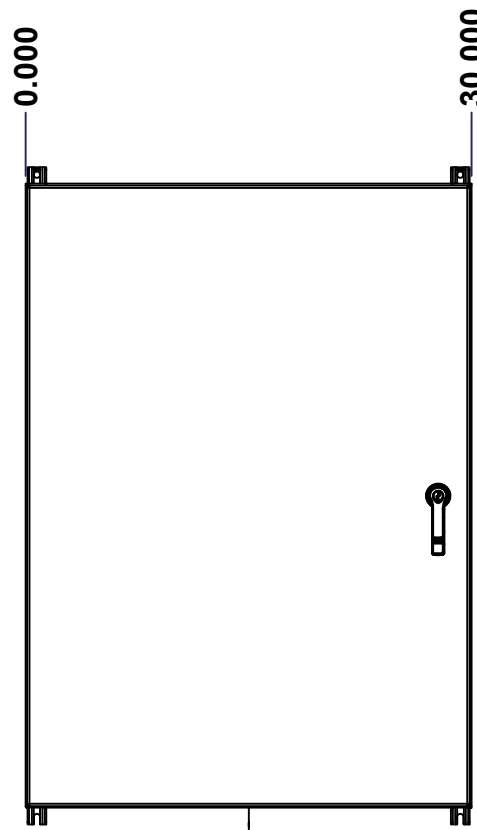

FRONT

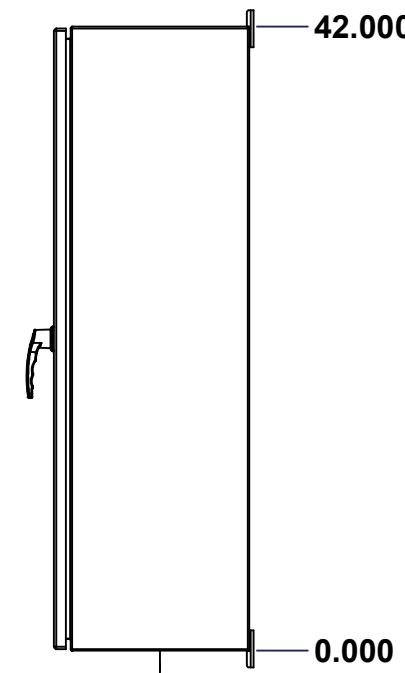

RIGHT

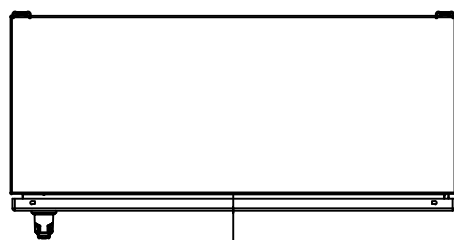

BOTTOM

No.	Revisions	Date	By/Par

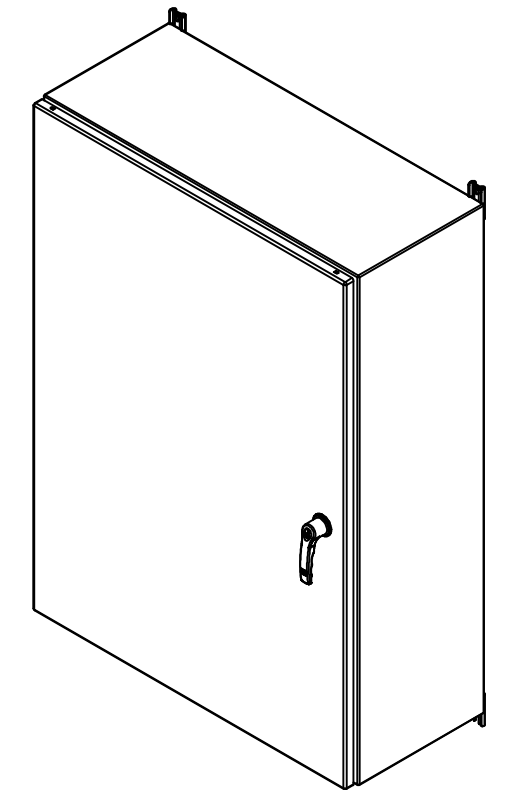

Isometric View



Tél: (450) 979-4373
 Fax: (450) 979-4626
www.exmweb.com

Flatness
Aplatissement

Max 3.0mm

Projection

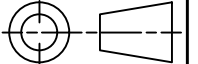

Customer Client	Date
Drawn By Dessiné Par BoxCad: BoxCad	Date 12-Apr-23
Material Matière 14 Ga Cold Rolled A1008 CS Type B (1.7mm)	

Color Couleur Asa-61 Grey	Finish Fini Smooth
------------------------------	-----------------------

Description 5412ESBU 42" x 30" x 12" Assembly	Detail Rev.
--	-------------

Part Number Numéro Pièce	Rev.	1
5412ESBU423012TH	0	16

SEE BILL OF MATERIAL ON LAST PAGE

This drawing is confidential and must not be reproduced or used without the consent of EXM

Ce dessin est confidentiel et ne doit pas être reproduit ou utilisé sans le consentement de EXM

NOTE	
ITEM	DESCRIPTION
1	NEMA 4/12 Enclosure
2	C/W Standard ground studs on box and cover
3	C/W Standard door stiffener
4	C/W Standard inner panel (Included)
5	C/W Standard inner panel mounting studs
6	C/W 885 ESMF3_OPEN Sold separately (Installed)
7	C/W 885 ESMF3_CLOSE Sold separately (Installed)
8	C/W R5 Insulation (Installed by EXM)

No.	Revisions	Date	By/Par

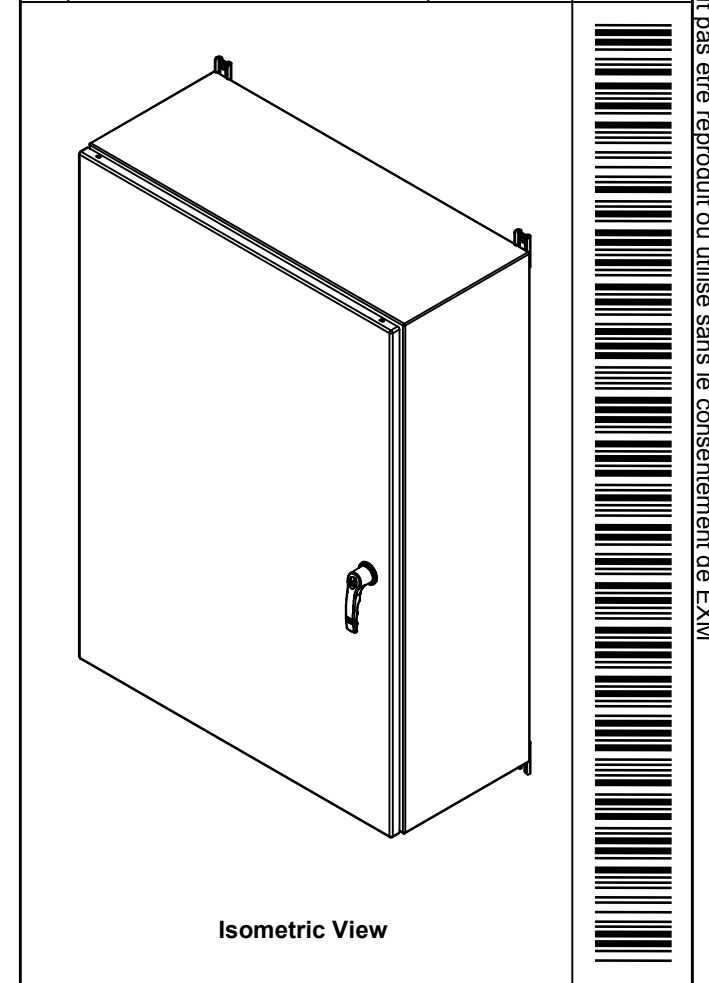

PACKING		
ITEM	QTY	DESCRIPTION
Cardboard sleeve	2	Top and Bottom
Cardboard strip	2	Between back of enclosure and inner panel
Plastic bag	1	To protect cover surface and inside gasket
Cardboard corner	4	To reinforced for the plastic strap tightening
Plastic strap - Black	2	To Squeeze the 2 cardboard sleeve together
Packaging label	3	White label with PN
Plastic strap- Green	2	To secure the enclosure to the wood pallet
Wood Pallet	1	2" deeper and 3" larger than enclosure size

6	STK-Q-00600	2	M12 to M8 Adaptor
1	881 SP4230G	0	881 SP - Inner Panel
1	STK-K-01800	5	5412 ES Accessory Kit
1	5412ESBU423012THC	0	5412ESBU 42" x 30" Cover
1	5412ESBU423012THB	0	5412ESBU 42" x 30" x 12" Body
6	STK-Q-04050-08	0	M6 x 8mm Hexagon Socket Head Machine Screw
Qty	Part Number	Rev	Description
Parts List			

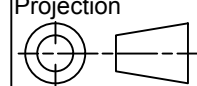
 Tél: (450) 979-4373 Fax: (450) 979-4626 www.exmweb.com		Flatness Aplatissement Max 3.0mm Projection 
Customer Client	Date	
Drawn By Dessiné Par	BoxCad: BoxCad	Date 12-Apr-23
Material Matière	14 Ga Cold Rolled A1008 CS Type B (1.7mm)	
Color Couleur	Asa-61 Grey	Finish Fini Smooth
Description		Detail Rev.
5412ESBU 42" x 30" x 12" Assembly		
Part Number Numéro Pièce	Rev.	2
5412ESBU423012TH	0	16

This drawing is confidential and must not be reproduced or used without the consent of EXM

Ce dessin est confidentiel et ne doit pas être reproduit ou utilisé sans le consentement de EXM

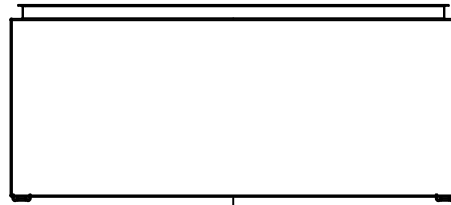

TOP

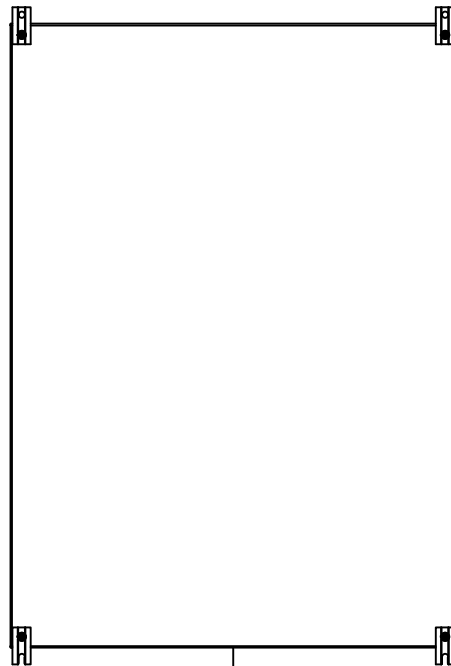

BACK

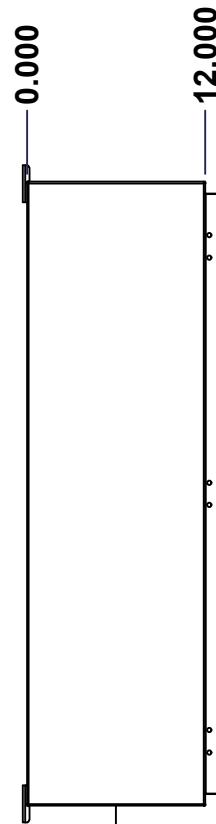

LEFT

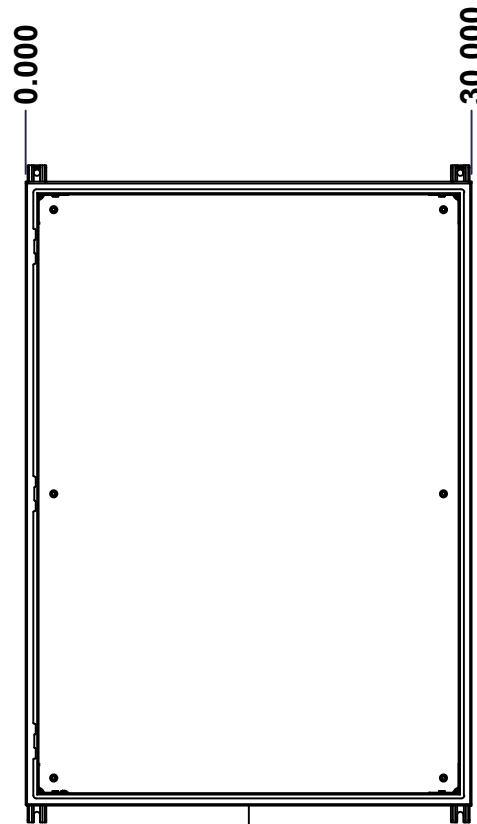

FRONT

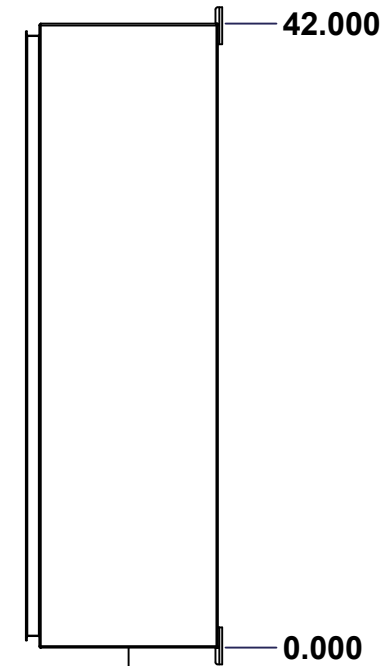

RIGHT

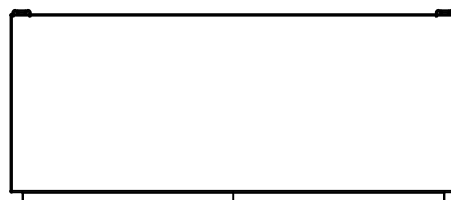

BOTTOM

No.	Revisions	Date	By/Par

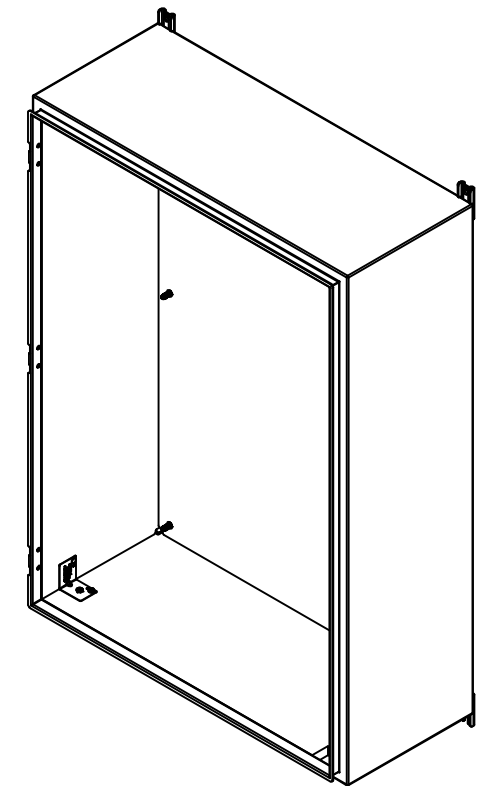

Isometric View



Tél: (450) 979-4373
 Fax: (450) 979-4626
www.exmweb.com

Flatness
Aplatissement

Max 3.0mm

Projection

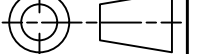

Customer Client	Date
Drawn By / Dessiné Par: BoxCad: BoxCad	Date: 12-Apr-23
Material / Matière: 14 Ga Cold Rolled A1008 CS Type B (1.7mm)	
Color / Couleur: Asa-61 Grey	Finish / Fini: Smooth
Description: 5412ESBU 42" x 30" x 12" Body	Detail Rev.
Part Number / Numéro Pièce: 5412ESBU423012THB	Rev. 3
SEE BILL OF MATERIAL ON LAST PAGE	0

This drawing is confidential and must not be reproduced or used without the consent of EXM

Ce dessin est confidentiel et ne doit pas être reproduit ou utilisé sans le consentement de EXM

STANDARD FEATURES ARE NOT LISTED IN THIS HOLE TABLE			
HOLE TABLE - TOP VIEW (CUSTOM FEATURE ONLY)			
CUT-OUT	XDIM	YDIM	DESCRIPTION
1	2.000	9.500	INSUL. STUD M6 x 18mm (Inside)
2	28.000	9.500	INSUL. STUD M6 x 18mm (Inside)

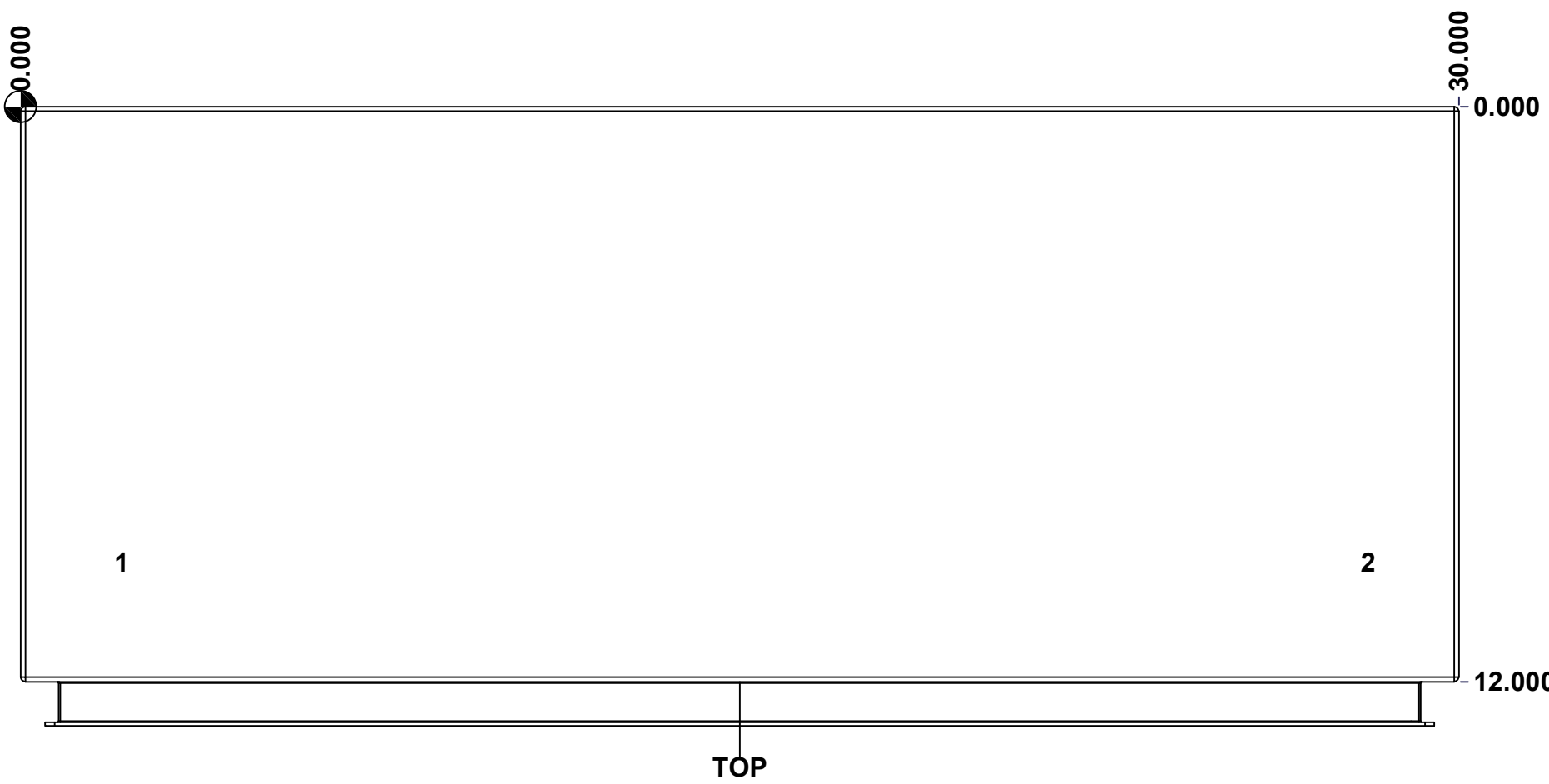

	Description	Status
	5412ESBU 42" x 30" x 12" Body	(NULL)
	Part Number Numéro Pièce	Rev.
	5412ESBU423012THB	0
		4
		16

This drawing is confidential and must not be reproduced or used without the consent of EXM

Ce dessin est confidentiel et ne doit pas être reproduit ou utilisé sans le consentement de EXM

STANDARD FEATURES ARE NOT LISTED IN THIS HOLE TABLE

HOLE TABLE - BOTTOM VIEW (CUSTOM FEATURE ONLY)

CUT-OUT	XDIM	YDIM	DESCRIPTION
1	2.000	9.500	INSUL. STUD M6 x 18mm (Inside)
2	28.000	9.500	INSUL. STUD M6 x 18mm (Inside)

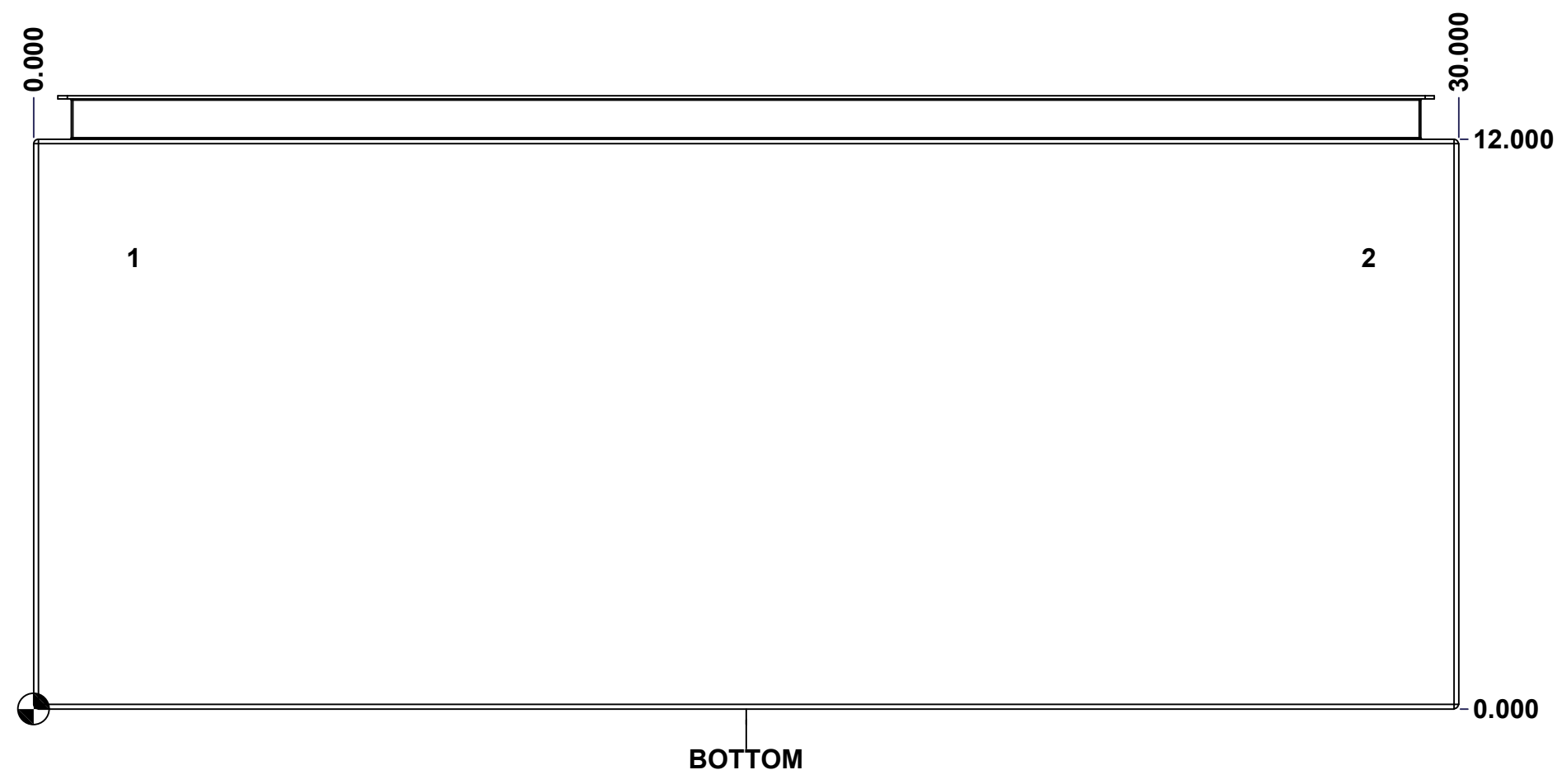

	Description	Status	
	5412ESBU 42" x 30" x 12" Body	(NULL)	
	Part Number Numéro Pièce	Rev.	
	5412ESBU423012THB	0	5 16

This drawing is confidential and must not be reproduced or used without the consent of EXM

Ce dessin est confidentiel et ne doit pas être reproduit ou utilisé sans le consentement de EXM

STANDARD FEATURES ARE NOT LISTED IN THIS HOLE TABLE

HOLE TABLE - BACK VIEW (CUSTOM FEATURE ONLY)

CUT-OUT	XDIM	YDIM	DESCRIPTION
1	1.875	1.875	IP STUD M8 x 35mm (Inside)
2	1.875	40.125	IP STUD M8 x 35mm (Inside)
3	28.125	40.125	IP STUD M8 x 35mm (Inside)
4	28.125	1.875	IP STUD M8 x 35mm (Inside)
5	1.875	21.000	IP STUD M8 x 35mm (Inside)
6	28.125	21.000	IP STUD M8 x 35mm (Inside)

7	29.250	0.000	FOOT 885 ESMF3_OPEN
8	0.750	0.000	FOOT 885 ESMF3_OPEN
9	29.250	42.000	FOOT 885 ESMF3_CLOSE
10	0.750	42.000	FOOT 885 ESMF3_CLOSE

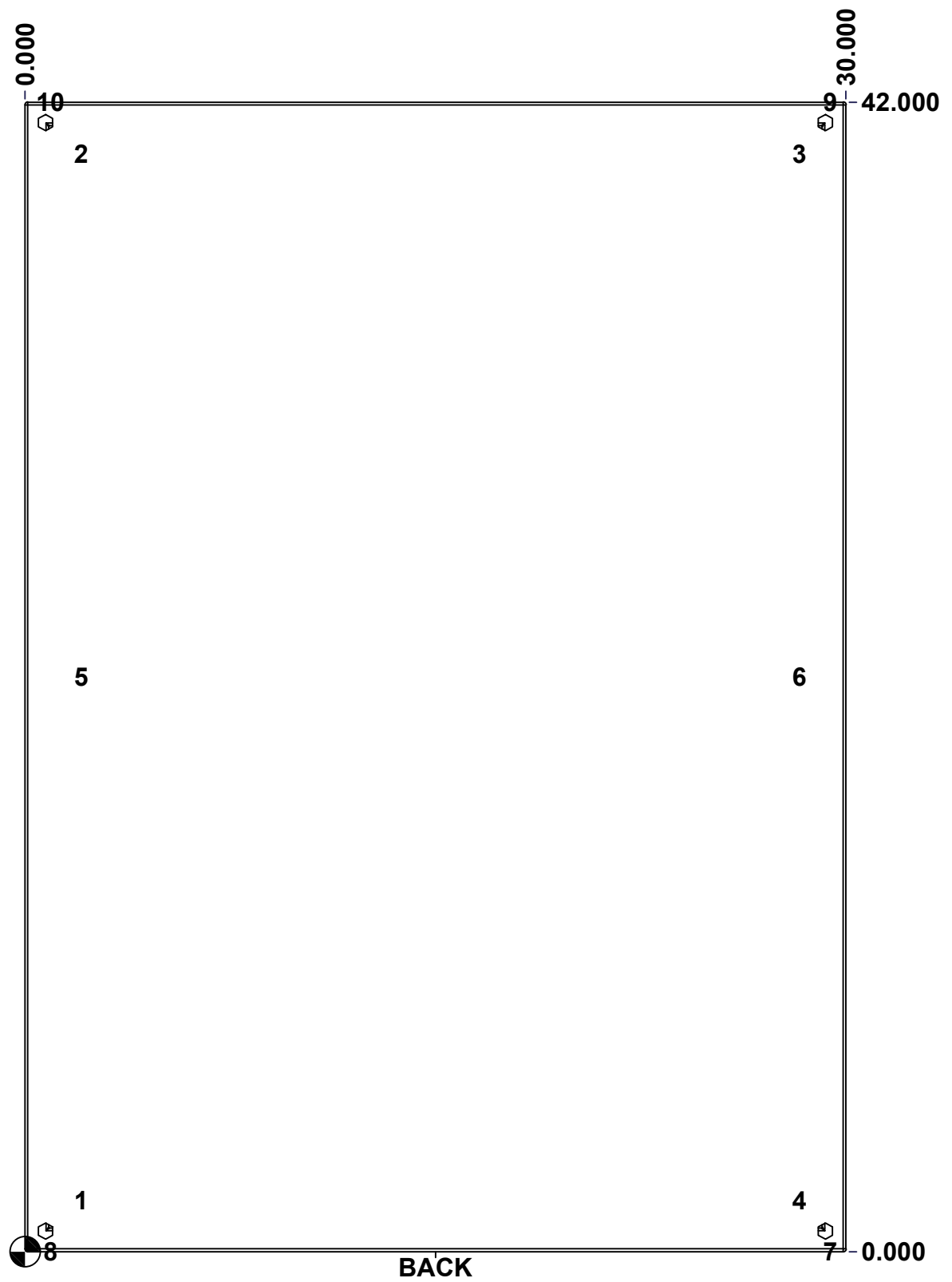

	Description	Status
	5412ESBU 42" x 30" x 12" Body	(NULL)
	Part Number Numéro Pièce	Rev.
	5412ESBU423012THB	0 / 6
		16

This drawing is confidential and must not be reproduced or used without the consent of EXM

Ce dessin est confidentiel et ne doit pas être reproduit ou utilisé sans le consentement de EXM

No.	Revisions	Date	By/Par

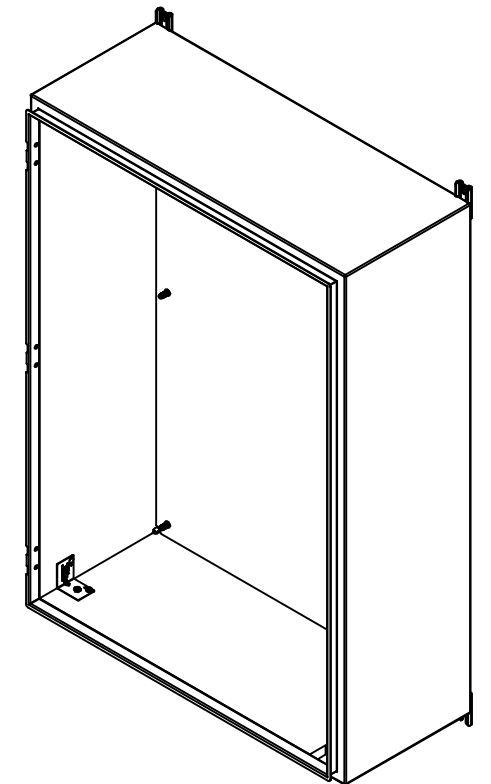

Isometric View



2	885ESMF3-FEET	0	885 ESMF3 Mounting Foot
4	RIVET_NUT_M10_FH_CE	0	Rivet Nut M10 (Low Profile Close End)
4	STK-Q-06660	2	M10 x 16mm Machine Screw
2	885ESMF3-FEET-A	0	885 ESMF3 Mounting Foot (Opened Slot)
1	STK-K-70554	3	5412 ESTH Accessory Kit
1	5412ESBU423012THI-RS	0	5412ESBU 42" x 30" Right Insulation
1	5412ESBU423012THI-LS	0	5412ESBU 42" x 30" Left Insulation
1	5412ESBU423012THI-BT	0	5412ESBU 42" x 30" Top and Bottom Insulation
1	5412ESBU423012THI-TP	0	5412ESBU 42" x 30" Top and Bottom Insulation
1	5412ESBU423012THI-B	0	5412ESBU 42" x 30" Back Insulation
4	STK-Q-16055	1	M6 x 18mm Stud (No Paint Cap Required)
1	STK-P-02400S	0	Powder Paint (Asa-61 Grey / Smooth)
6	STK-Q-16005	1	Stud M8 x 35 (No Paint Cap Required)
1	5412ESBU423012THB-P	0	5412ESBU 42" x 30" x 12" Body Part

Qty	Part Number	Rev	Description
Parts List			

	Tél: (450) 979-4373 Fax: (450) 979-4626 www.exmweb.com	Flatness Aplatissement Max 3.0mm
	Projection 	Customer Client
Drawn By Dessiné Par BoxCad: BoxCad	Date 12-Apr-23	Material Matière 14 Ga Cold Rolled A1008 CS Type B (1.7mm)
Color Couleur Asa-61 Grey	Finish Fini Smooth	Description 5412ESBU 42" x 30" x 12" Body
Part Number Numéro Pièce 5412ESBU423012THB	Rev. 0	Detail Rev. 7 16

This drawing is confidential and must not be reproduced or used without the consent of EXM

Ce dessin est confidentiel et ne doit pas être reproduit ou utilisé sans le consentement de EXM

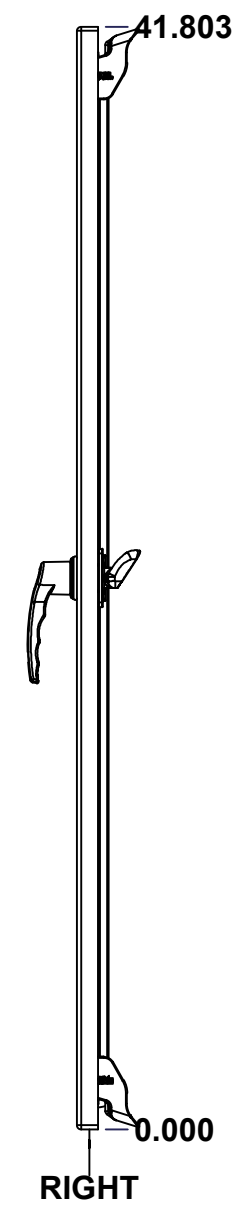
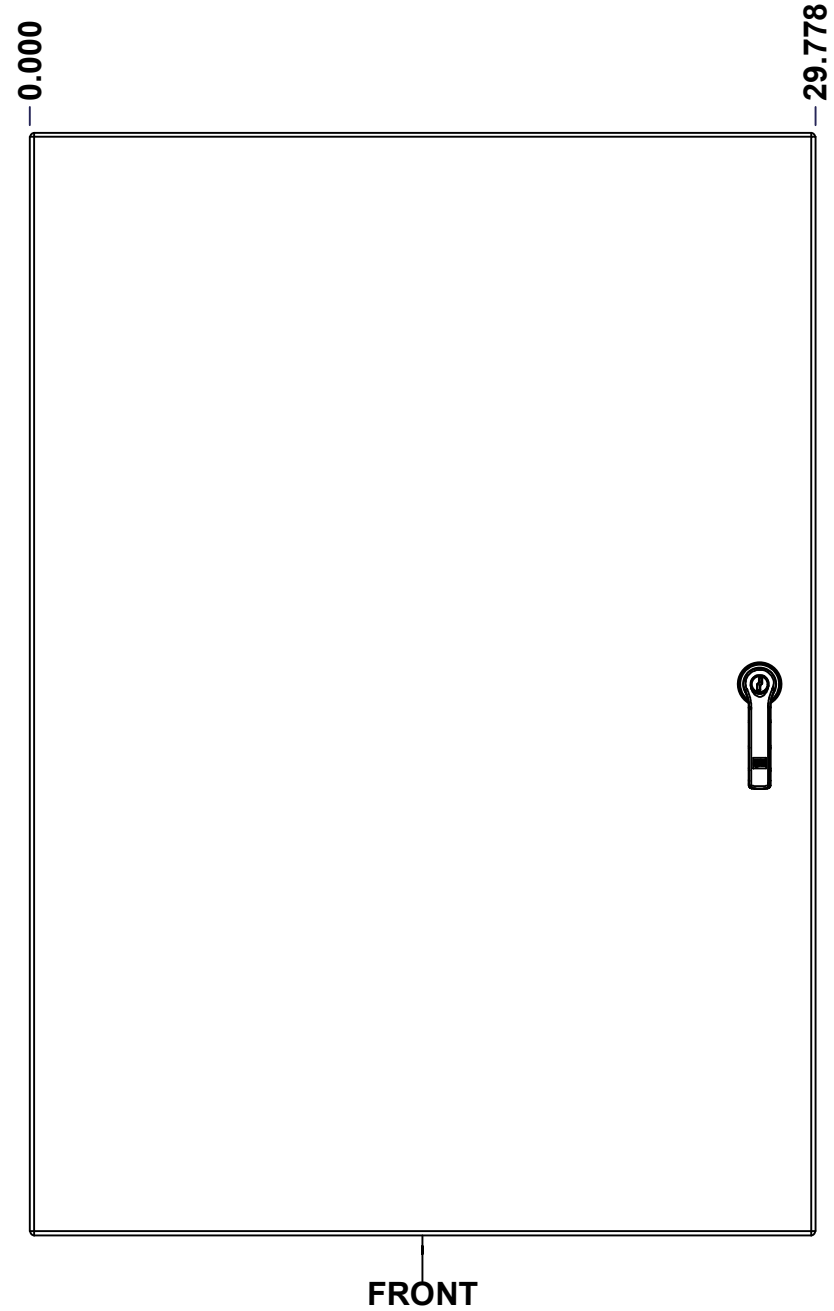
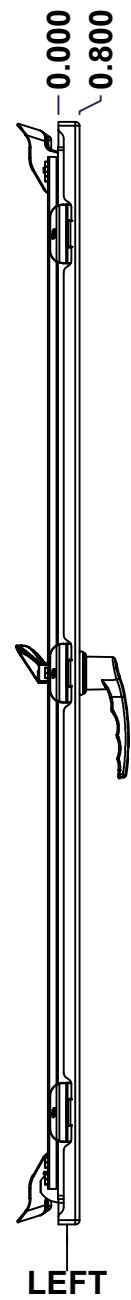
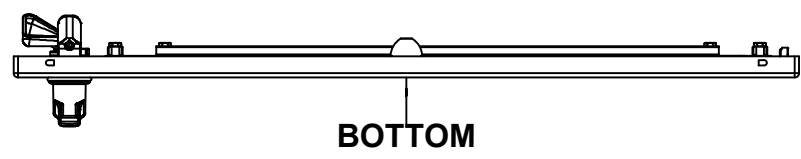
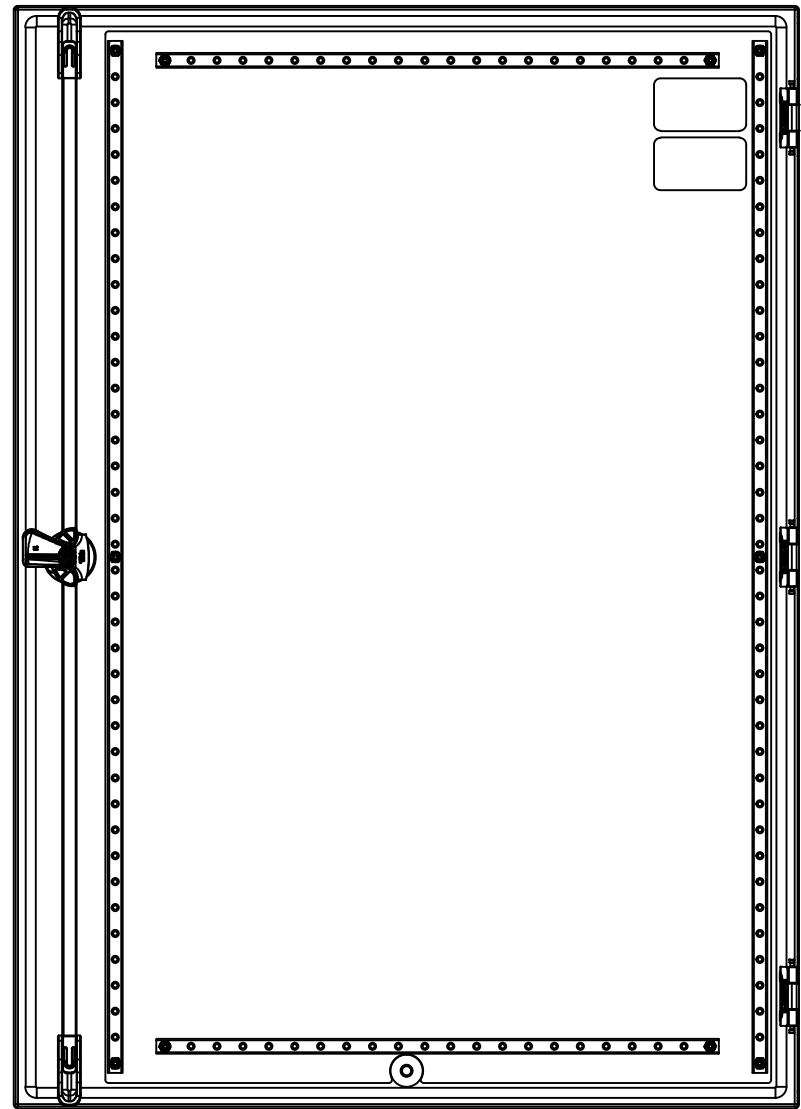
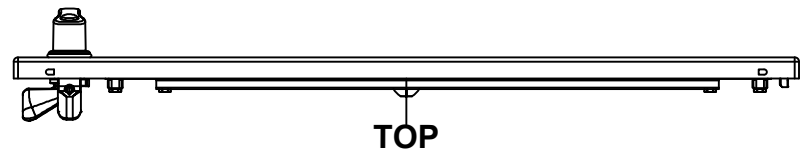

No.	Revisions	Date	By/Par

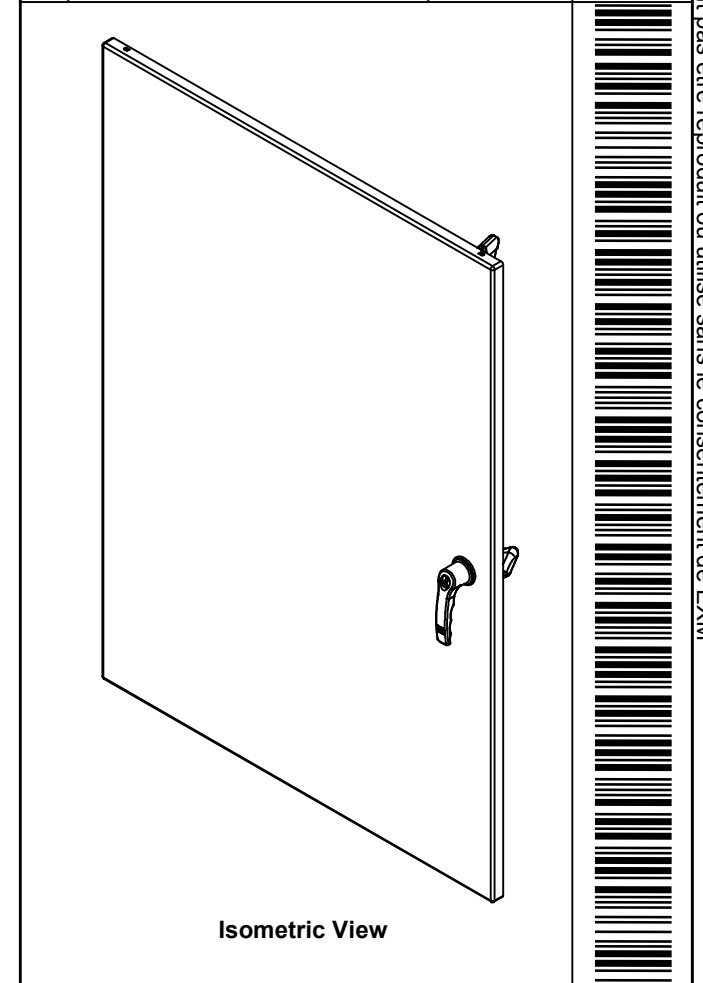

 Tél: (450) 979-4373 Fax: (450) 979-4626 www.exmweb.com		Flatness Aplatissement	
		Max 3.0mm	
Customer Client		Date	
Drawn By Dessiné Par BoxCad: BoxCad		Date 12-Apr-23	
Material Matière 14 Ga Cold Rolled A1008 CS Type B (1.7mm)			
Color Couleur Asa-61 Grey		Finish Fini Smooth	
Description 5412ESBU 42" x 30" Cover			Detail Rev.
Part Number Numéro Pièce 5412ESBU423012THC		Rev. 0	8 16

SEE BILL OF MATERIAL ON LAST PAGE

This drawing is confidential and must not be reproduced or used without the consent of EXM

Ce dessin est confidentiel et ne doit pas être reproduit ou utilisé sans le consentement de EXM

STANDARD FEATURES ARE NOT LISTED IN THIS HOLE TABLE

HOLE TABLE - FRONT VIEW (CUSTOM FEATURE ONLY)

CUT-OUT	XDIM	YDIM	DESCRIPTION
1	1.486	1.709	STUD M6 x 18mm (Inside)
2	1.486	40.094	STUD M6 x 18mm (Inside)
3	25.923	40.094	STUD M6 x 18mm (Inside)
4	25.923	1.709	STUD M6 x 18mm (Inside)
5	1.486	20.902	STUD M6 x 18mm (Inside)
6	25.923	20.902	STUD M6 x 18mm (Inside)
7	1.893	2.350	STUD M6 x 18mm (Inside)
8	1.893	39.733	STUD M6 x 18mm (Inside)
9	25.516	39.733	STUD M6 x 18mm (Inside)
10	25.516	2.350	STUD M6 x 18mm (Inside)
11	27.663	36.896	CLOSING BAR STUD (Inside)
12	27.663	4.907	CLOSING BAR STUD (Inside)
13	14.889	1.435	STUD M6 x 18mm (Inside)

14	27.663	20.902	885 ESL2A

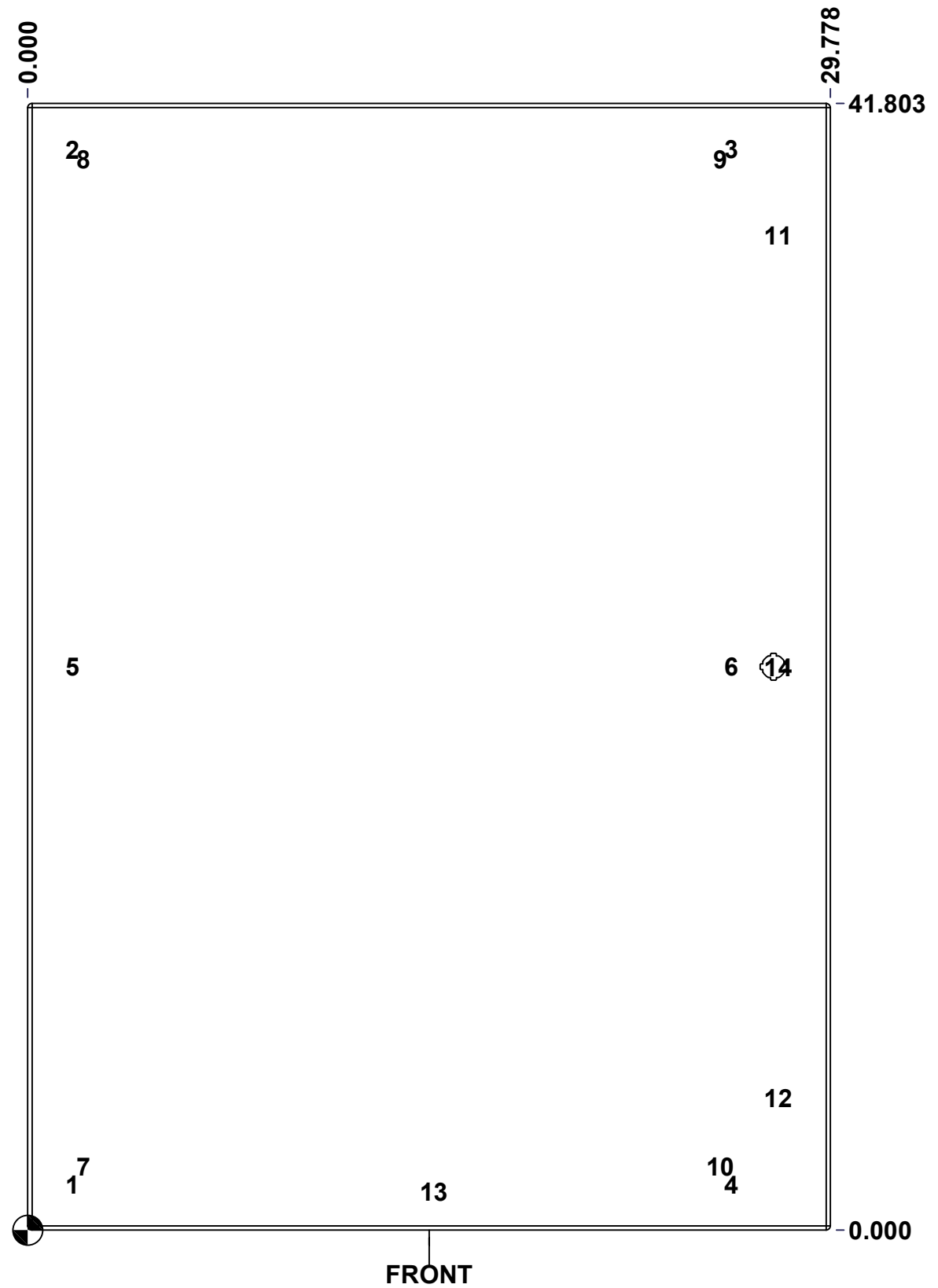

	Description	Status
	5412ESBU 42" x 30" Cover	(NULL)
	Part Number Numéro Pièce	Rev.
	5412ESBU423012THC	0
		9
		16

This drawing is confidential and must not be reproduced or used without the consent of EXM

Ce dessin est confidentiel et ne doit pas être reproduit ou utilisé sans le consentement de EXM

No.	Revisions	Date	By/Par

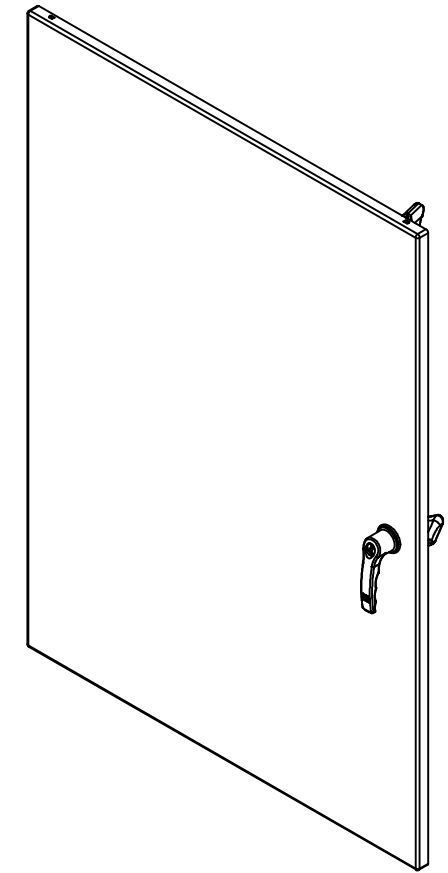

Isometric View



2	STK-Q-90042	4	5412 ES - Cabinet Closing Bar End (Small)
2	STK-Q-45655-42	0	5412 ES - Closing Bar
1	STK-Q-50536	13	5412 ES - Handle Cam Clockwise (Grip 32mm)
1	STK-Q-90051	3	5412 ES - Handle Cam Spacer
1	885 ESL2A	4	5412 ES Key Lock L-Handle (3 Pts)
2	STK-S-00100	0	3.5" x 2" Silver Milar Flexcon Sticker
10	STK-Q-07250	2	M6 x 16mm Collar Nut
2	STK-Q-46020-24	5	5412 ES Vertical Door Stiffener 24"
2	STK-Q-46020-42	5	5412 ES Vertical Door Stiffener 42"
1	5412ESBU423012THI-C	0	5412ESBU 42" x 30" Cover Insulation
1	STK-P-02400S	0	Powder Paint (Asa-61 Grey / Smooth)
1	STK-Q-46515	3	5412 ES Door Support with Brass Insert
2	STK-Q-16405	6	Guide Stud - Small (No Paint Cap Required)
11	STK-Q-16055	1	M6 x 18mm Stud (No Paint Cap Required)
3	STK-A-33005	4	5412 ESBU Hinge 180° (Body Part)
1	5412ESBU423012THG	0	5412ESBU 42" x 30" Cover Gasket Part
1	5412ESBU423012THC-P	0	5412ESBU 42" x 30" Cover Part

QTY	Part Number	Rev	Description
Parts List			

Tél: (450) 979-4373 Fax: (450) 979-4626 www.exmweb.com	Flatness Aplatissement	Max 3.0mm
	Projection	
Customer Client	Date	
Drawn By Dessiné Par	BoxCad: BoxCad	Date 12-Apr-23
Material Matière	14 Ga Cold Rolled A1008 CS Type B (1.7mm)	
Color Couleur	Asa-61 Grey	Finish Fini Smooth
Description	Detail Rev.	
5412ESBU 42" x 30" Cover		
Part Number Numéro Pièce	Rev.	10
5412ESBU423012THC		0
		16

This drawing is confidential and must not be reproduced or used without the consent of EXM

Ce dessin est confidentiel et ne doit pas être reproduit ou utilisé sans le consentement de EXM

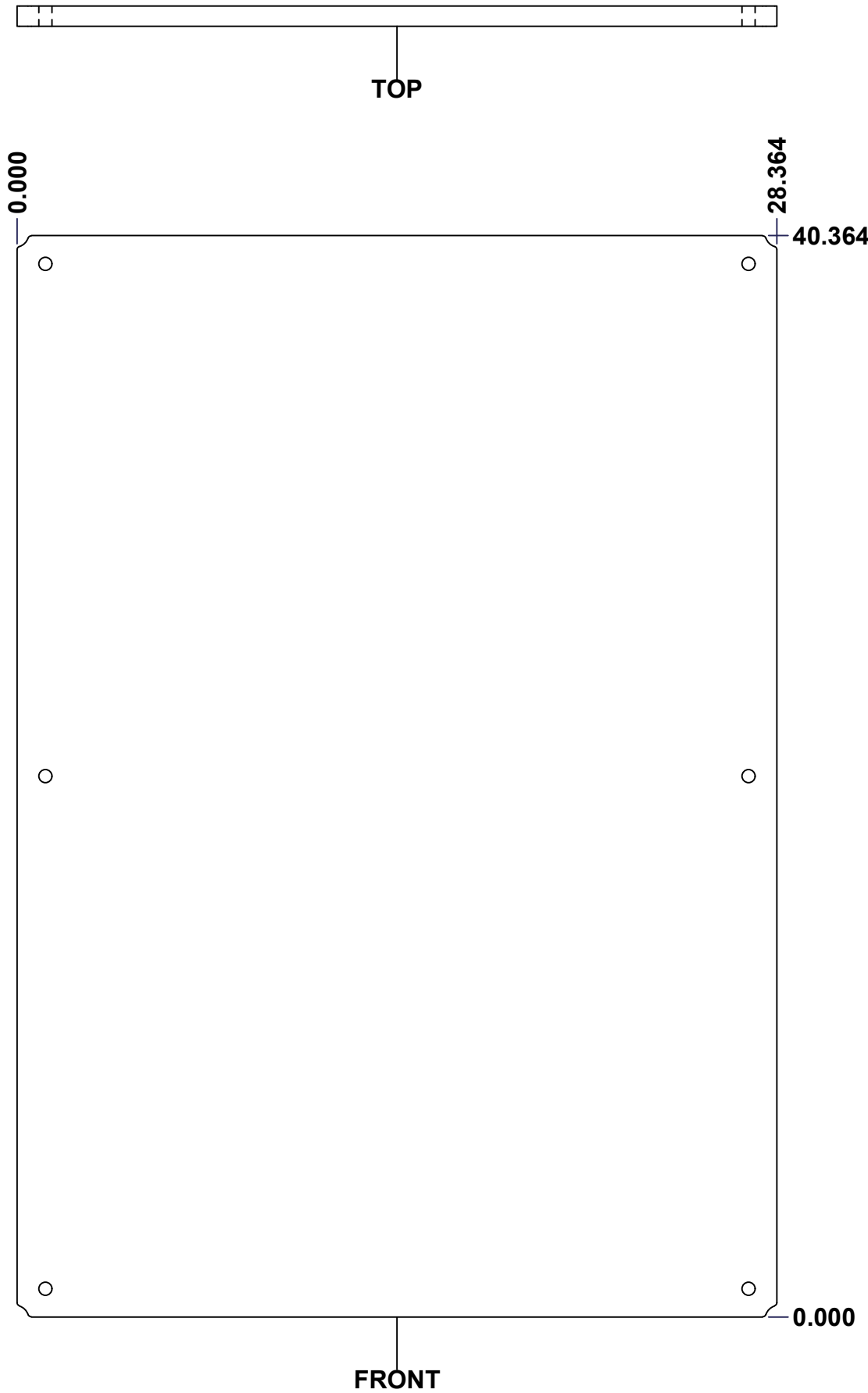

No.	Revisions	Date	By/Par

Isometric View

<p>Tél: (450) 979-4373 Fax: (450) 979-4626 www.exmweb.com</p>		Flatness Aplatissement
		Max 3.0mm
		Projection
Customer Client	Date	
Drawn By Dessiné Par	BoxCad: Patrick Deschenes	Date 23-Jan-07
Material Matière	Polyisocyanurate	
Color Couleur	Aluminum	Finish Fini N/A
Description		Detail Rev.
5412ESBU 42" x 30" Back Insulation		
Part Number Numéro Pièce	Rev.	11
5412ESBU423012THI-B	0	16

SEE BILL OF MATERIAL ON LAST PAGE

This drawing is confidential and must not be reproduced or used without the consent of EXM

Ce dessin est confidentiel et ne doit pas être reproduit ou utilisé sans le consentement de EXM

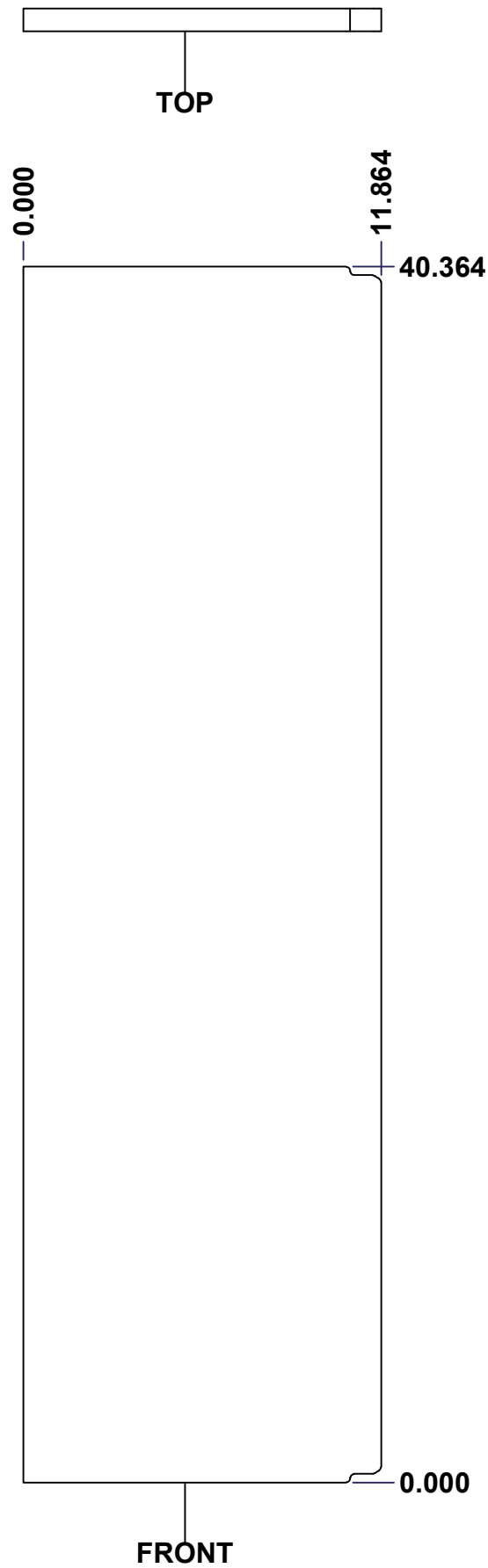

No.	Revisions	Date	By/Par

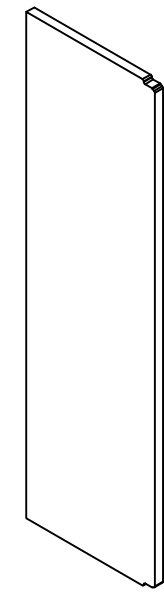

Isometric View



Tél: (450) 979-4373
 Fax: (450) 979-4626
www.exmweb.com

Flatness
 Aplatissement
 Max 3.0mm
 Projection

Customer Client	Date
Drawn By Dessiné Par	Date 23-Jan-07
Material Matière	Polyisocyanurate
Color Couleur	Aluminum
Finish Fini	N/A
Description	Detail Rev.
5412ESBU 42" x 30" Left Insulation	
Part Number Numéro Pièce	Rev. 12
5412ESBU423012THI-LS	0 16

SEE BILL OF MATERIAL ON LAST PAGE

This drawing is confidential and must not be reproduced or used without the consent of EXM

Ce dessin est confidentiel et ne doit pas être reproduit ou utilisé sans le consentement de EXM

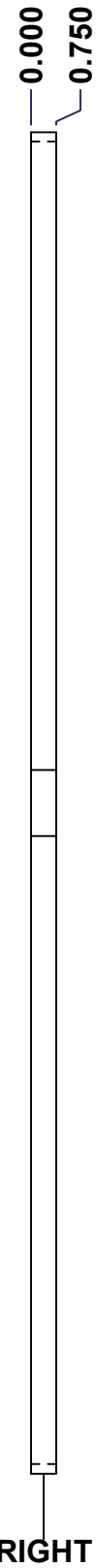
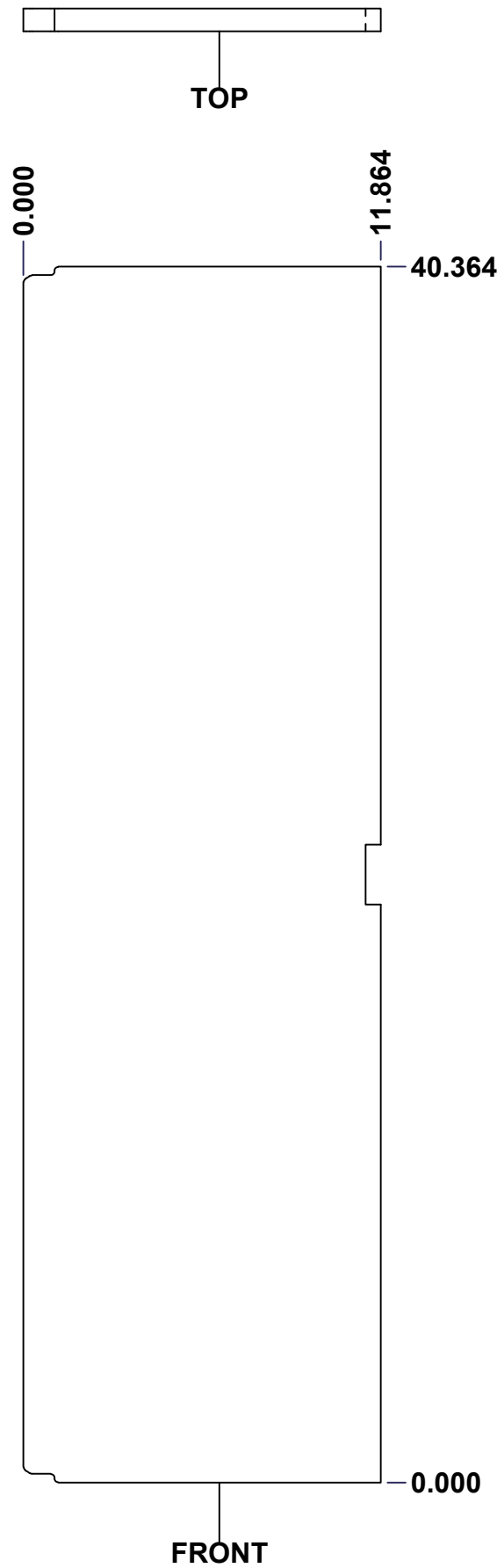

Isometric View

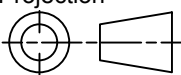

No.	Revisions	Date	By/Par

 Tél: (450) 979-4373 Fax: (450) 979-4626 www.exmweb.com		Flatness Aplatissement Max 3.0mm
Projection 		Date 23-Jan-07
Customer Client	Date	
Drawn By Dessiné Par	BoxCad: Patrick Deschenes	Date 23-Jan-07
Material Matière	Polyisocyanurate	
Color Couleur	Aluminum	Finish Fini N/A
Description	Detail Rev.	
5412ESBU 42" x 30" Right Insulation		
Part Number Numéro Pièce	Rev. 0	13 / 16

SEE BILL OF MATERIAL ON LAST PAGE

5412ESBU423012THI-RS

This drawing is confidential and must not be reproduced or used without the consent of EXM

Ce dessin est confidentiel et ne doit pas être reproduit ou utilisé sans le consentement de EXM

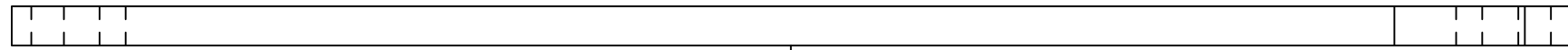

TOP



FRONT

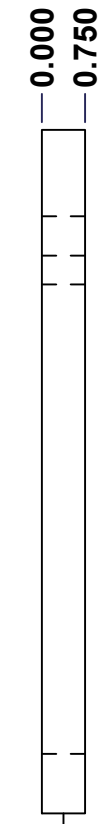

RIGHT

No.	Revisions	Date	By/Par

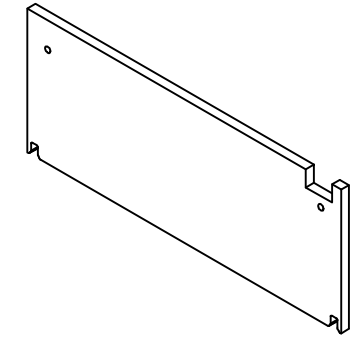

Isometric View

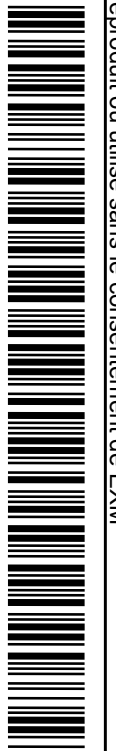

Tél: (450) 979-4373
 Fax: (450) 979-4626
www.exmweb.com

Flatness
Aplatissement
Max 3.0mm
Projection

Customer Client	Date
Drawn By / Dessiné Par: BoxCad: Patrick Deschenes	Date: 23-Jan-07
Material / Matière: Polyisocyanurate	
Color / Couleur: Aluminum	Finish / Fini: N/A
Description: 5412ESBU 42" x 30" Top and Bottom Insulation	Detail Rev.
Part Number / Numéro Pièce: 5412ESBU423012THI-TP	Rev. 0

SEE BILL OF MATERIAL ON LAST PAGE

This drawing is confidential and must not be reproduced or used without the consent of EXM

Ce dessin est confidentiel et ne doit pas être reproduit ou utilisé sans le consentement de EXM

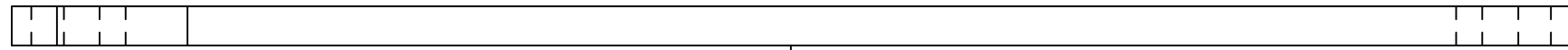

TOP

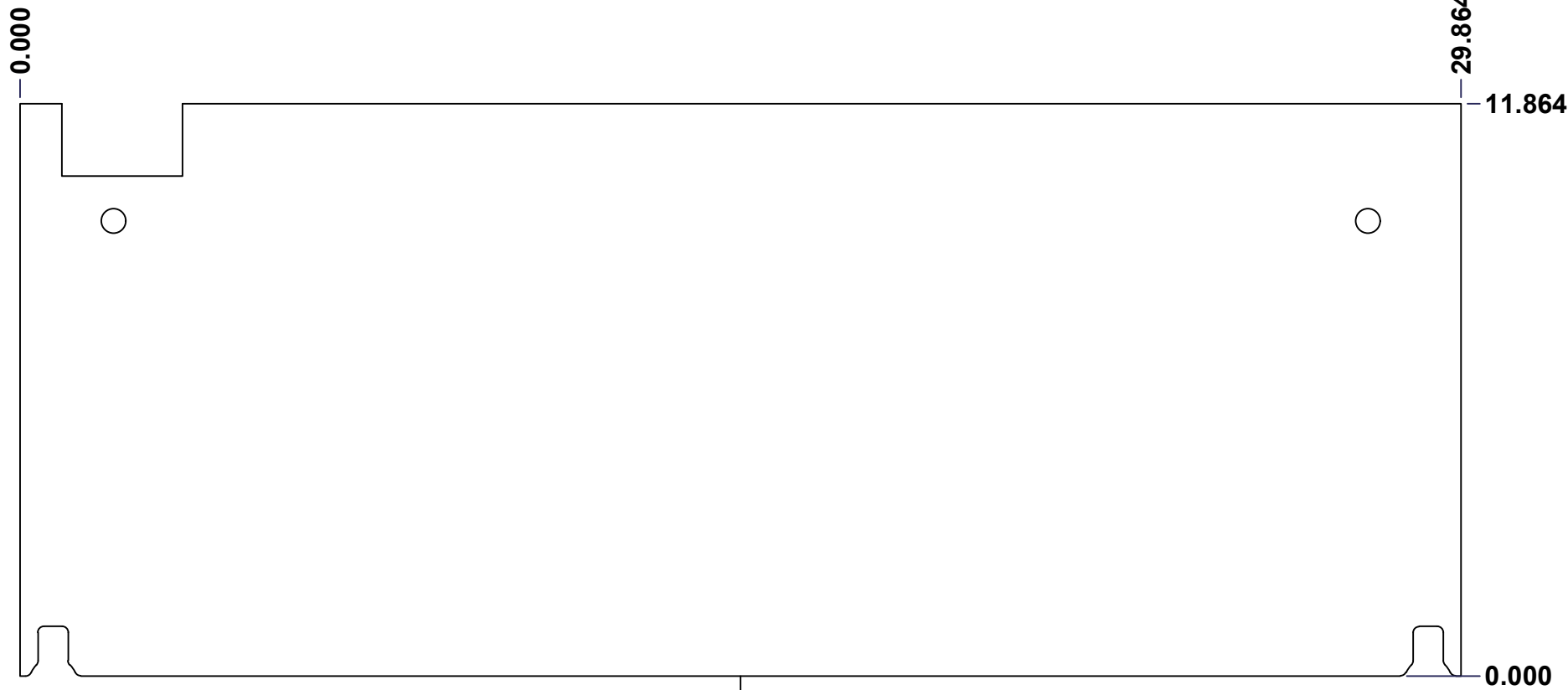

FRONT

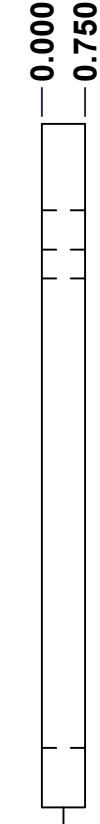

RIGHT

No.	Revisions	Date	By/Par

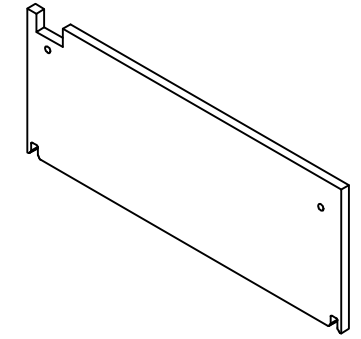

Isometric View



Tél: (450) 979-4373
 Fax: (450) 979-4626
www.exmweb.com

Flatness
Aplatissement
Max 3.0mm
Projection

Customer Client	Date
Drawn By / Dessiné Par: BoxCad: Patrick Deschenes	Date: 23-Jan-07
Material / Matière: Polyisocyanurate	
Color / Couleur: Aluminum	Finish / Fini: N/A
Description: 5412ESBU 42" x 30" Top and Bottom Insulation	Detail Rev.
Part Number / Numéro Pièce: 5412ESBU423012THI-BT	Rev. 0

SEE BILL OF MATERIAL ON LAST PAGE

This drawing is confidential and must not be reproduced or used without the consent of EXM

Ce dessin est confidentiel et ne doit pas être reproduit ou utilisé sans le consentement de EXM

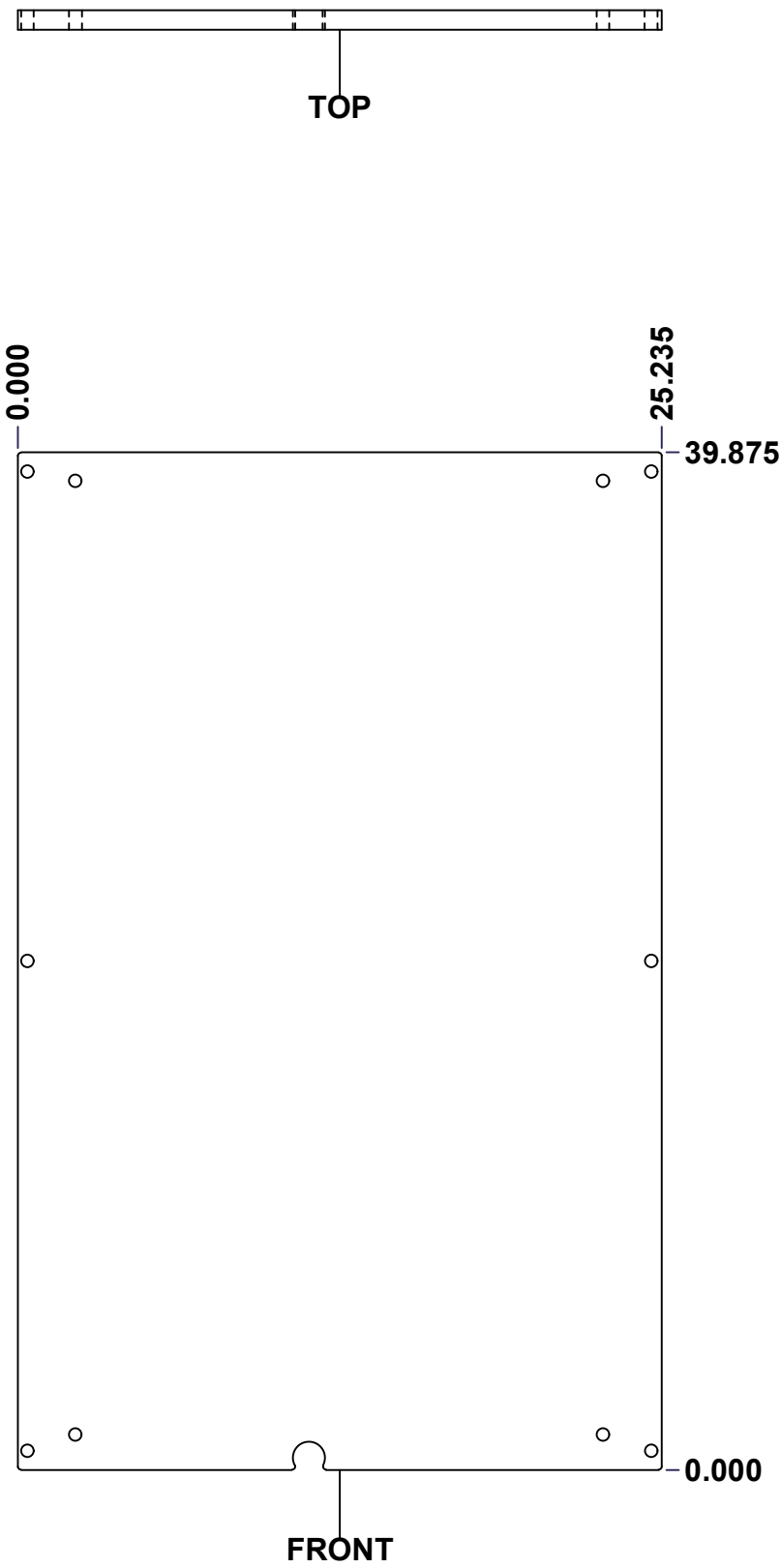

No.	Revisions	Date	By/Par

Isometric View

Tél: (450) 979-4373 Fax: (450) 979-4626 www.exmweb.com		Flatness Aplatissement	
		Max 3.0mm	
Projection		Date	
Customer Client	BoxCad: Patrick Deschenes	Date	23-Jan-07
Material Matière	Polyisocyanurate		
Color Couleur	Aluminum	Finish Fini	N/A
Description		Detail Rev.	
5412ESBU 42" x 30" Cover Insulation			
Part Number Numéro Pièce	Rev.	16	16
5412ESBU423012THI-C	0		

SEE BILL OF MATERIAL ON LAST PAGE

This drawing is confidential and must not be reproduced or used without the consent of EXM

Tolerance ±1/32" unless otherwise specified

C:\Vault Workspace\Inventor Dwg\Inv-8\881SP\881SP4230G.idw

Tolérance ±1/32" sauf spécification contraire

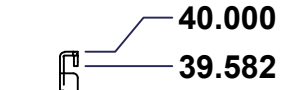
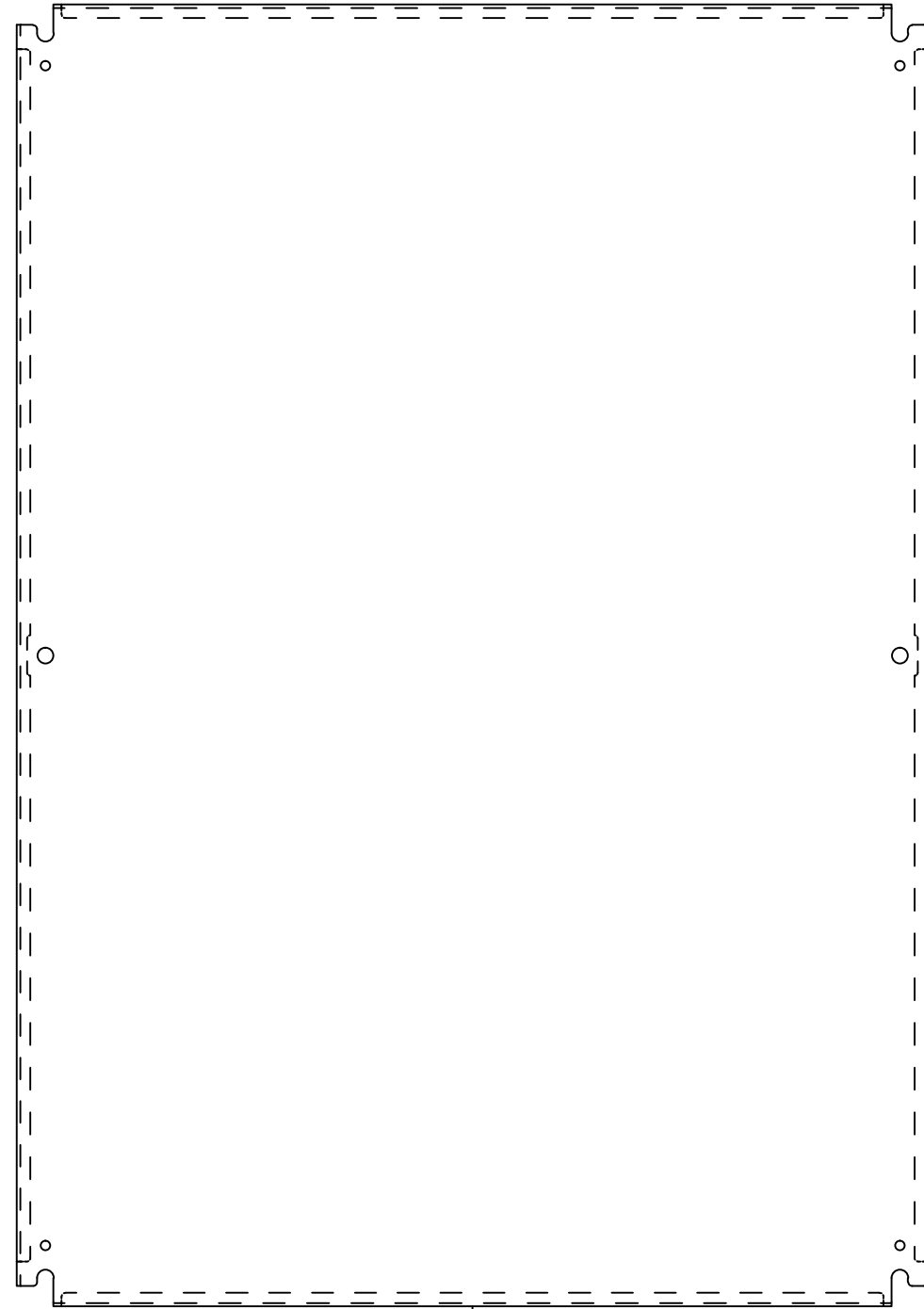
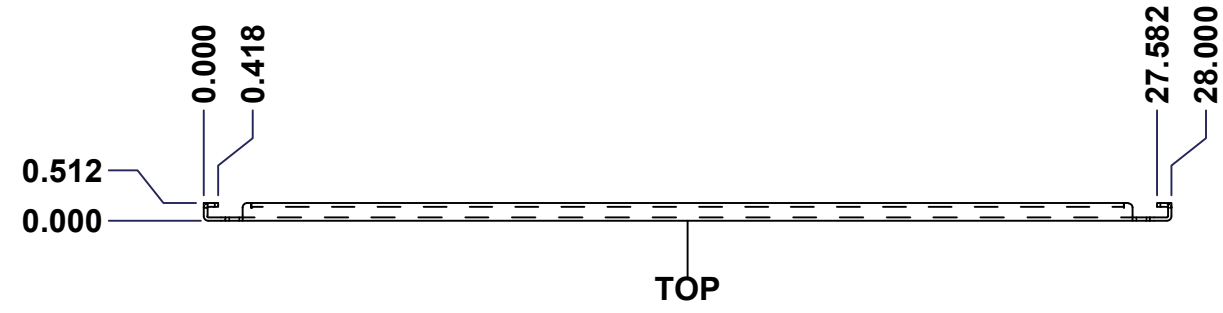

No.	Revisions	Date	By/Par

Isometric View

Flatness
Aplatissement
Max 3.0mm

Projection

Customer Client
Date

Drawn By / Dessiné Par: BoxCad
Date: 23-Jan-07

Material / Matière: See Part List

Color / Couleur: See Part List
Finish / Fini: See Part List

Description: 881 SP - Inner Panel
Detail Rev.

Qty	Part Number	Rev	Description	Material	Color	Finish
1	881 SP4230G-P	0	881 SP - Inner Panel Part	12 Ga Galvanized	Unpainted	Galvanized

Parts List

Part Number / Numéro Pièce: **881 SP4230G**

Rev. 0

1 / 2

Ce dessin est confidentiel et ne doit pas être reproduit ou utilisé sans le consentement de EXM

This drawing is confidential and must not be reproduced or used without the consent of EXM

Ce dessin est confidentiel et ne doit pas être reproduit ou utilisé sans le consentement de EXM

Table 1			FRONT VIEW
CUT-OUT	XDIM	YDIM	DESCRIPTION
1	0.875	1.875	GROUND HOLE (RND Ø0.290)
2	27.125	1.875	GROUND HOLE (RND Ø0.290)
3	0.875	38.125	GROUND HOLE (RND Ø0.290)
4	27.125	38.125	GROUND HOLE (RND Ø0.290)
5	0.875	20.000	MTG STUD HOLE (RND Ø0.500)
6	27.125	20.000	MTG STUD HOLE (RND Ø0.500)

All knockouts are actual size / Les disques défonçables sont grandeur réel

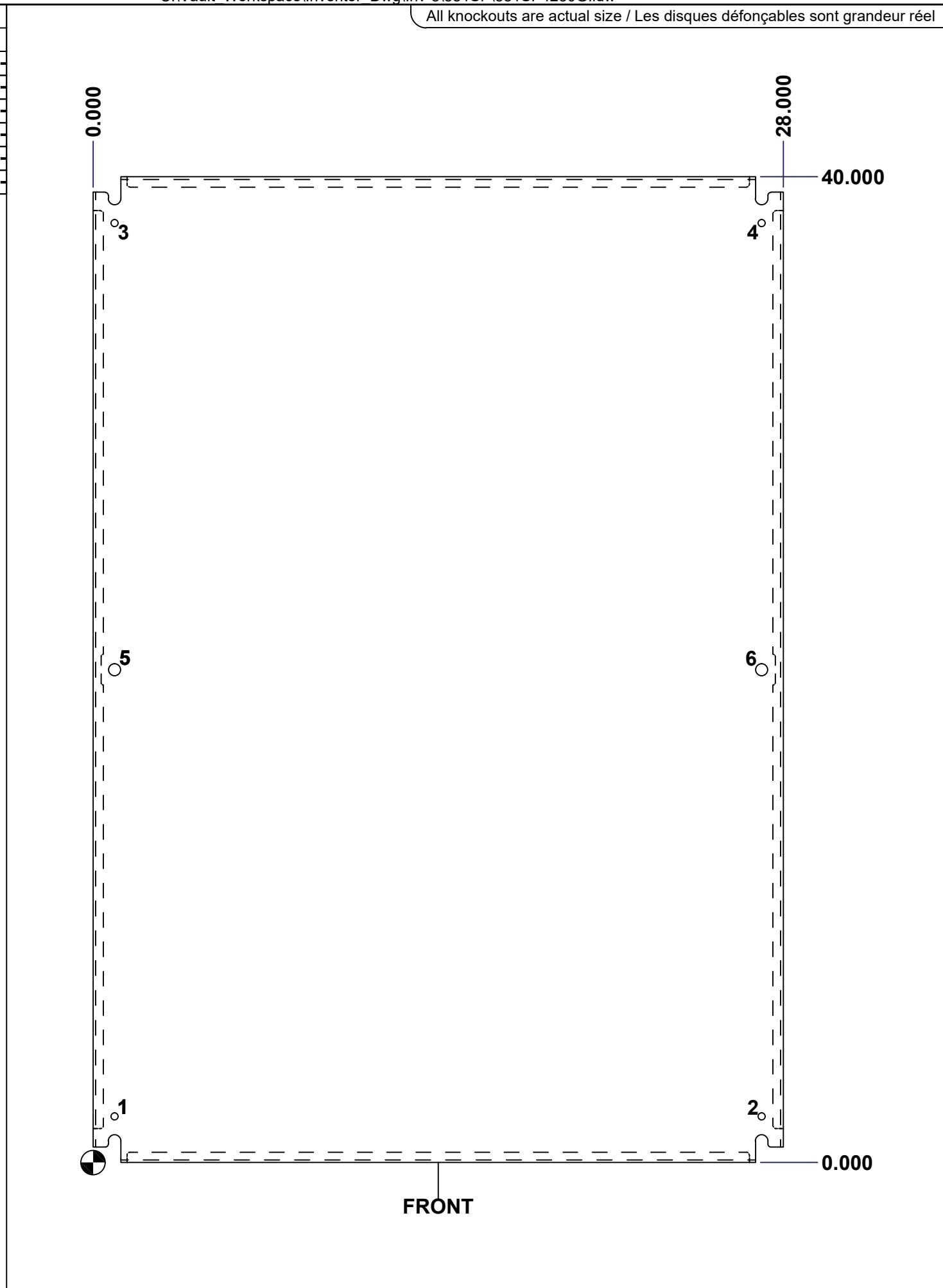

No.	Revisions	Date	By/Par

Isometric View

		Tél: (450) 979-4373 Fax: (450) 979-4626 www.exmweb.com		Flatness Aplatissement Max 3.0mm	
Customer Client		Date		Projection 	
Drawn By Dessiné Par BoxCad		Date 23-Jan-07		Material Matière See Part List	
Color Couleur See Part List		Finish Fini See Part List		Description 881 SP - Inner Panel	
Part Number Numéro Pièce 881 SP4230G		Rev. 0		Detail Rev. 2 / 2	