

This drawing is confidential and must not be reproduced or used without the consent of EXM

Ce dessin est confidentiel et ne doit pas être reproduit ou utilisé sans le consentement de EXM

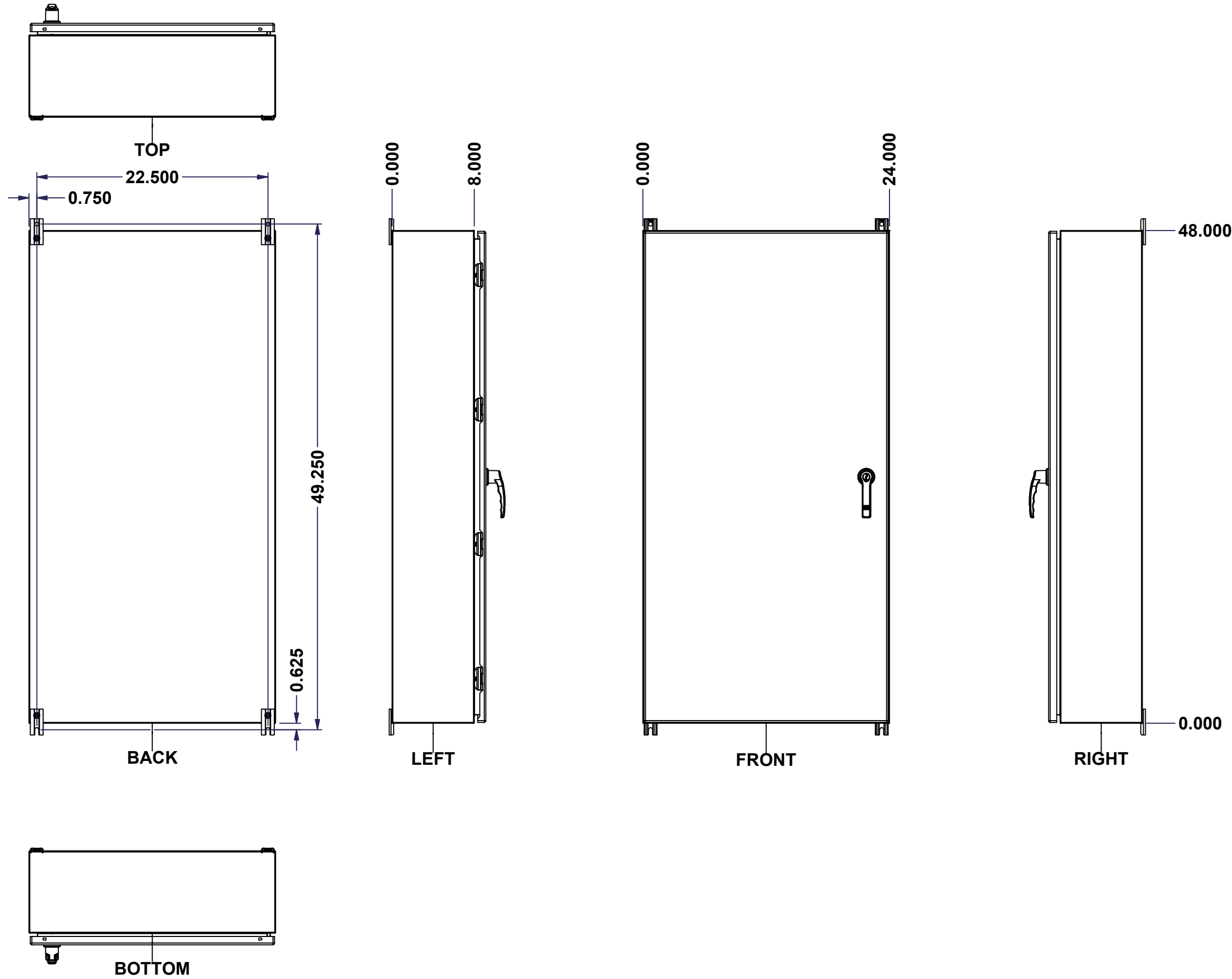

No.	Revisions	Date	By/Par

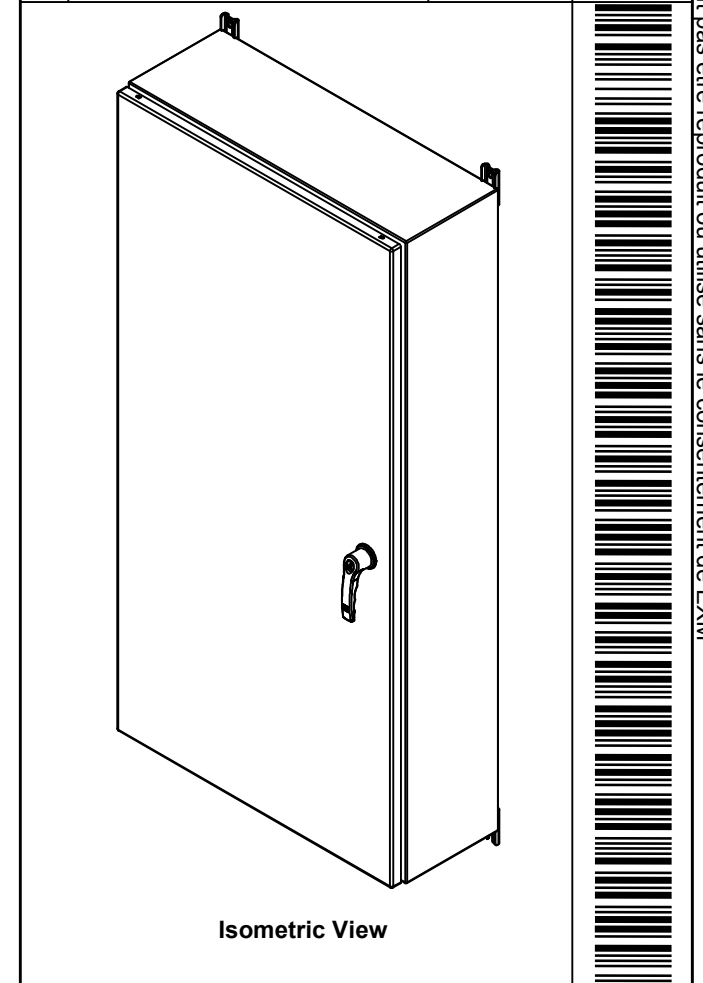

Tél: (450) 979-4373 Fax: (450) 979-4626 <a href="http://www.exmweb.com">www.exmweb.com</a>		Flatness Aplatissement	Max 3.0mm
		Projection	
Customer Client	Date		
Drawn By Dessiné Par	BoxCad: BoxCad	Date	13-Apr-23
Material Matière	16 Ga Cold Rolled A1008 CS Type B (1.4mm)		
Color Couleur	Asa-61 Grey	Finish Fini	Smooth
Description	5412ESBU 48" x 24" x 8" Assembly		Detail Rev.
Part Number Numéro Pièce	SEE BILL OF MATERIAL ON LAST PAGE	5412ESBU482408THNOIP	Rev. 0
			1 16

SEE BILL OF MATERIAL ON LAST PAGE 5412ESBU482408THNOIP

This drawing is confidential and must not be reproduced or used without the consent of EXM

Ce dessin est confidentiel et ne doit pas être reproduit ou utilisé sans le consentement de EXM

NOTE	
ITEM	DESCRIPTION
1	NEMA 4/12 Enclosure
2	C/W Standard ground studs on box and cover
3	C/W Standard door stiffener
4	W/O Inner panel
5	C/W Standard inner panel mounting studs
6	C/W 885 ESMF3_OPEN Sold separately (Installed)
7	C/W 885 ESMF3_CLOSE Sold separately (Installed)
8	C/W R5 Insulation (Installed by EXM)

No.	Revisions	Date	By/Par

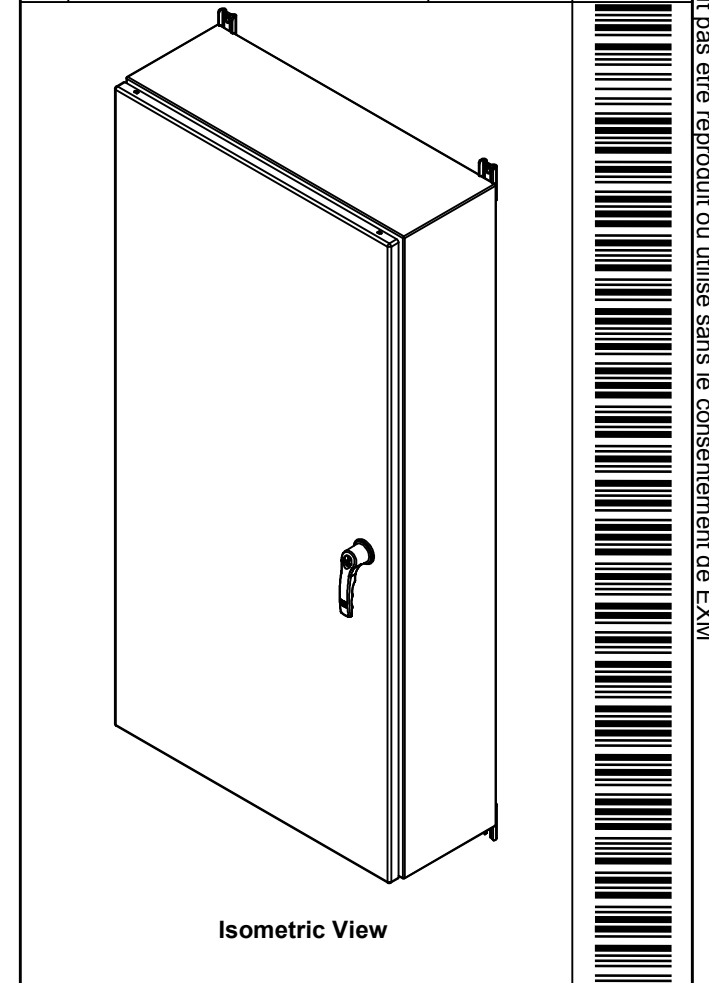

 Tél: (450) 979-4373  
 Fax: (450) 979-4626  
[www.exmweb.com](http://www.exmweb.com)

Flatness / Aplatissement: Max 3.0mm  
 Projection: 

Customer Client	Date
Drawn By / Dessiné Par: BoxCad: BoxCad	Date: 13-Apr-23
Material / Matière: 16 Ga Cold Rolled A1008 CS Type B (1.4mm)	

Color / Couleur: Asa-61 Grey	Finish / Fini: Smooth
Description: 5412ESBU 48" x 24" x 8" Assembly	Detail Rev.:
Part Number / Numéro Pièce: <b>5412ESBU482408THNOIP</b>	Rev. <b>0</b>

PACKING		
ITEM	QTY	DESCRIPTION
Cardboard sleeve	2	Top and Bottom
Cardboard strip	2	Between back of enclosure and inner panel
Plastic bag	1	To protect cover surface and inside gasket
Cardboard corner	4	To reinforced for the plastic strap tightening
Plastic strap - Black	2	To Squeeze the 2 cardboard sleeve together
Packaging label	3	White label with PN
Plastic strap- Green	2	To secure the enclosure to the wood pallet
Wood Pallet	1	2" deeper and 3" larger than enclosure size

6	STK-Q-00600	2	M12 to M8 Adaptor
1	STK-K-01800	5	5412 ES Accessory Kit
1	5412ESBU482408THNOI PC	0	5412ESBU 48" x 24" Cover
1	5412ESBU482408THNOI PB	0	5412ESBU 48" x 24" x 8" Body
8	STK-Q-04050-08	0	M6 x 8mm Hexagon Socket Head Machine Screw
Qty	Part Number	Rev	Description
Parts List			

This drawing is confidential and must not be reproduced or used without the consent of EXM

Ce dessin est confidentiel et ne doit pas être reproduit ou utilisé sans le consentement de EXM

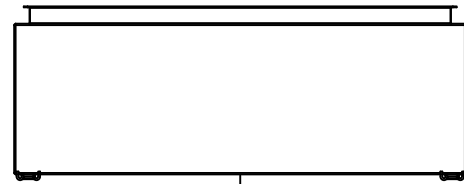

TOP

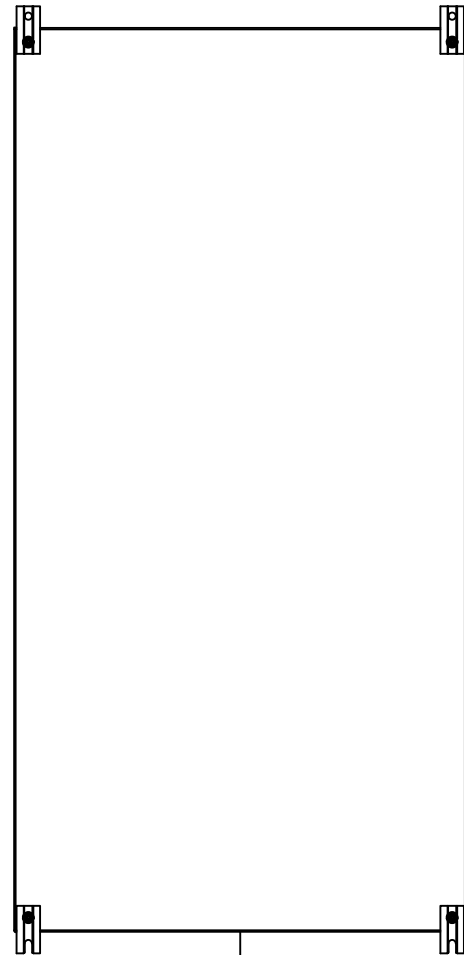

BACK

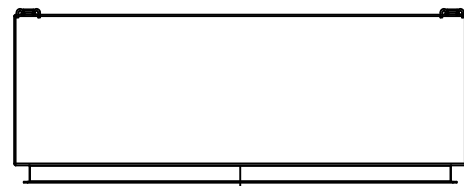

BOTTOM

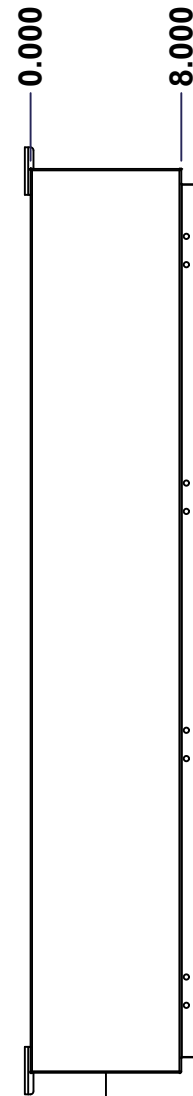

LEFT

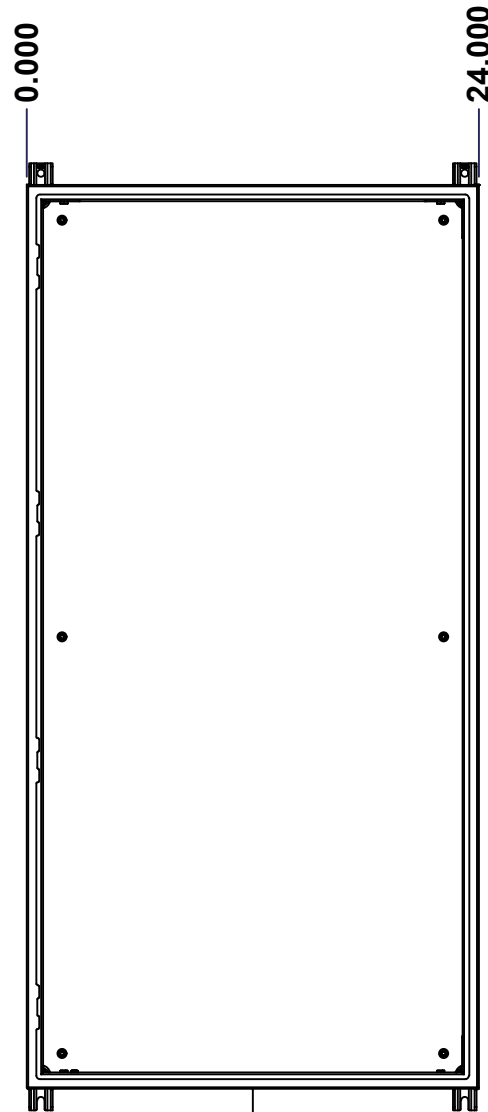

FRONT

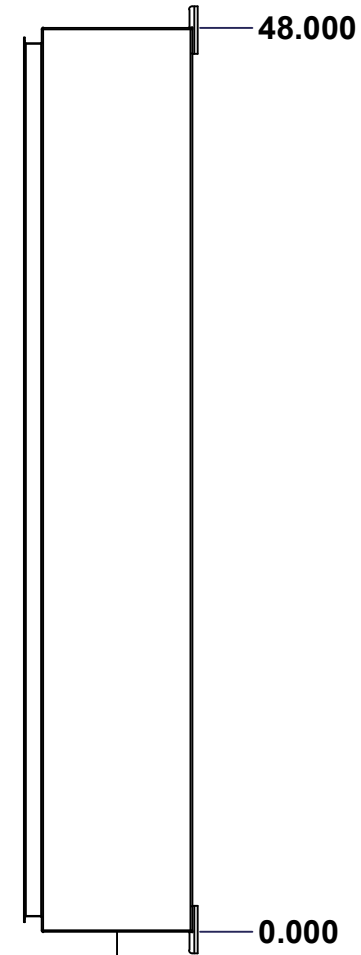

RIGHT

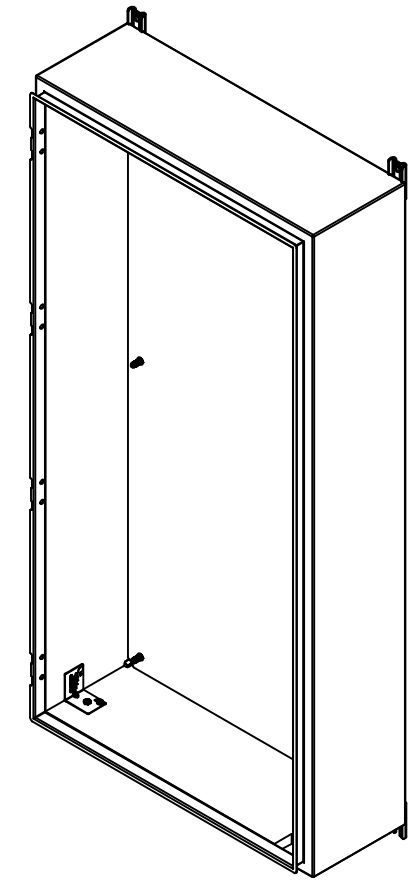

Isometric View

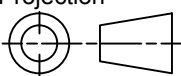

No.	Revisions	Date	By/Par

 Tél: (450) 979-4373 Fax: (450) 979-4626 <a href="http://www.exmweb.com">www.exmweb.com</a>		Flatness Aplatissement Max 3.0mm Projection 
Customer Client	Date	
Drawn By Dessiné Par	BoxCad: BoxCad	Date 13-Apr-23
Material Matière	16 Ga Cold Rolled A1008 CS Type B (1.4mm)	
Color Couleur	Asa-61 Grey	Finish Fini Smooth
Description	Detail Rev.	
5412ESBU 48" x 24" x 8" Body		
Part Number Numéro Pièce	Rev. 0	3 / 16

SEE BILL OF MATERIAL ON LAST PAGE 5412ESBU482408THNOIPB

This drawing is confidential and must not be reproduced or used without the consent of EXM

Ce dessin est confidentiel et ne doit pas être reproduit ou utilisé sans le consentement de EXM

STANDARD FEATURES ARE NOT LISTED IN THIS HOLE TABLE			
HOLE TABLE - TOP VIEW (CUSTOM FEATURE ONLY)			
CUT-OUT	XDIM	YDIM	DESCRIPTION
1	2.000	5.500	INSUL. STUD M6 x 18mm (Inside)
2	22.000	5.500	INSUL. STUD M6 x 18mm (Inside)

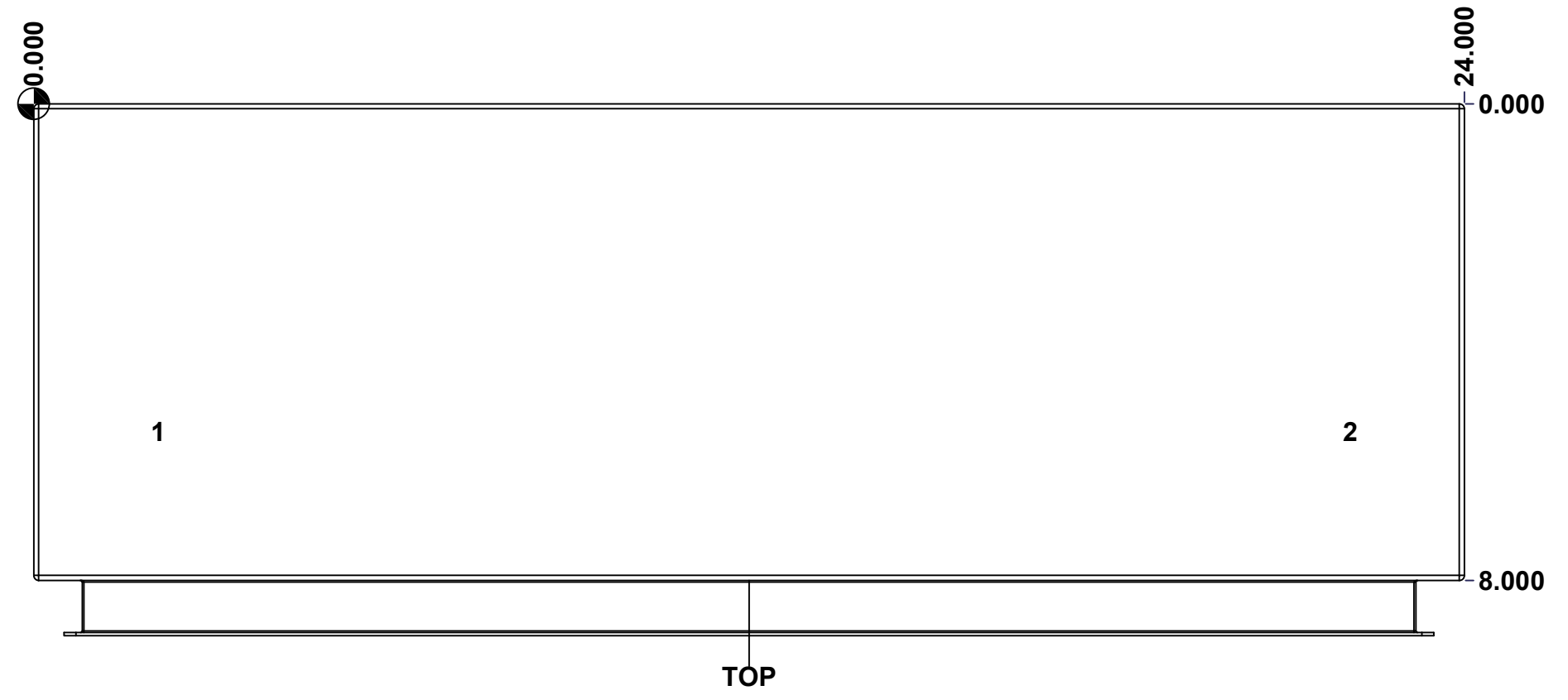

	Description	Status
	5412ESBU 48" x 24" x 8" Body	(NULL)
	Part Number Numéro Pièce	Rev.
	<b>5412ESBU482408THNOIPB</b>	<b>0</b>
		4
		16

This drawing is confidential and must not be reproduced or used without the consent of EXM

Ce dessin est confidentiel et ne doit pas être reproduit ou utilisé sans le consentement de EXM

<b>STANDARD FEATURES ARE NOT LISTED IN THIS HOLE TABLE</b>			
<b>HOLE TABLE - BOTTOM VIEW (CUSTOM FEATURE ONLY)</b>			
CUT-OUT	XDIM	YDIM	DESCRIPTION
1	2.000	5.500	INSUL. STUD M6 x 18mm (Inside)
2	22.000	5.500	INSUL. STUD M6 x 18mm (Inside)

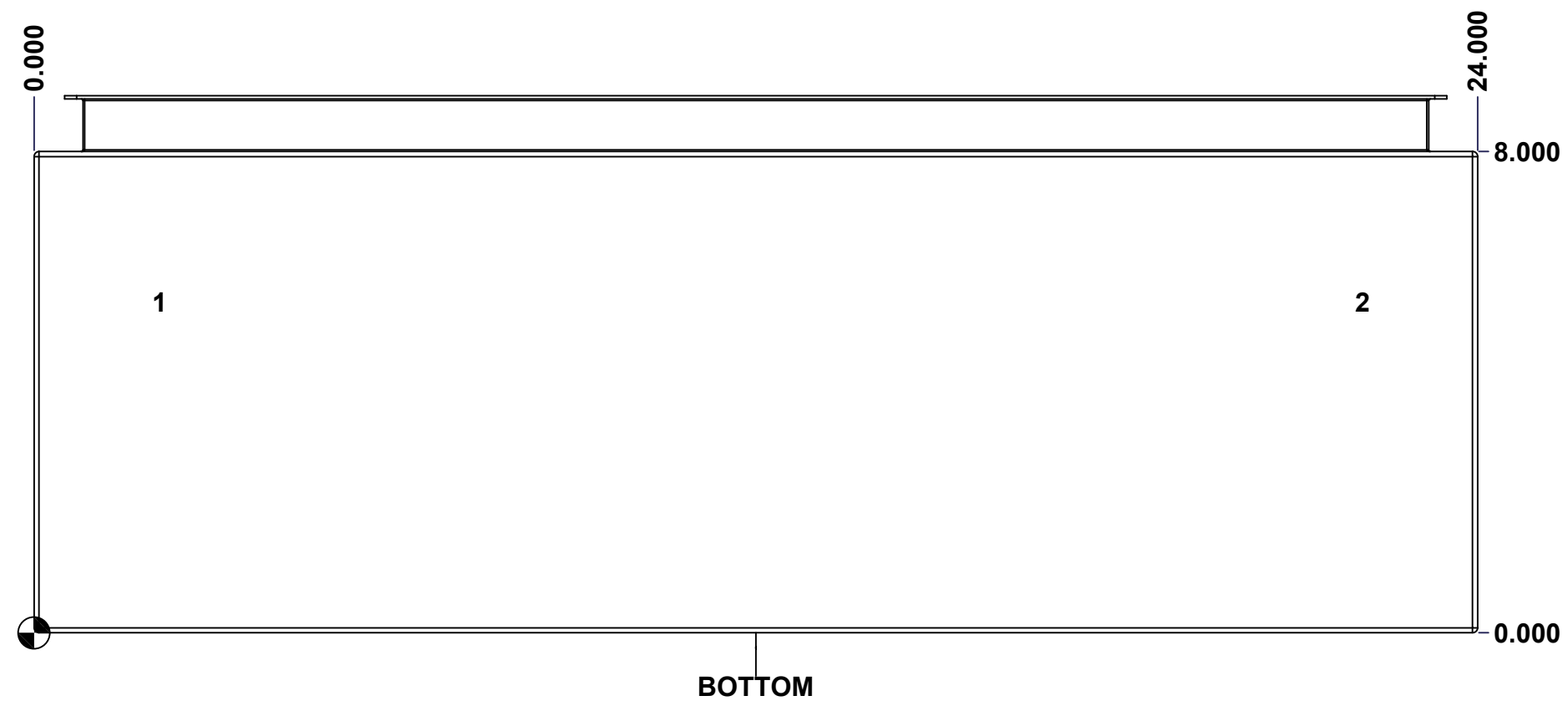

	Description	Status
	5412ESBU 48" x 24" x 8" Body	(NULL)
	Part Number Numéro Pièce	Rev. 5
	<b>5412ESBU482408THNOIPB</b>	<b>0</b>
		16

This drawing is confidential and must not be reproduced or used without the consent of EXM

Ce dessin est confidentiel et ne doit pas être reproduit ou utilisé sans le consentement de EXM

**STANDARD FEATURES ARE NOT LISTED IN THIS HOLE TABLE**

**HOLE TABLE - BACK VIEW (CUSTOM FEATURE ONLY)**

CUT-OUT	XDIM	YDIM	DESCRIPTION
1	1.875	1.875	IP STUD M8 x 35mm (Inside)
2	1.875	46.125	IP STUD M8 x 35mm (Inside)
3	22.125	46.125	IP STUD M8 x 35mm (Inside)
4	22.125	1.875	IP STUD M8 x 35mm (Inside)
5	1.875	24.000	IP STUD M8 x 35mm (Inside)
6	22.125	24.000	IP STUD M8 x 35mm (Inside)
-----			
7	23.250	0.000	FOOT 885 ESMF3_OPEN
8	0.750	0.000	FOOT 885 ESMF3_OPEN
9	23.250	48.000	FOOT 885 ESMF3_CLOSE
10	0.750	48.000	FOOT 885 ESMF3_CLOSE

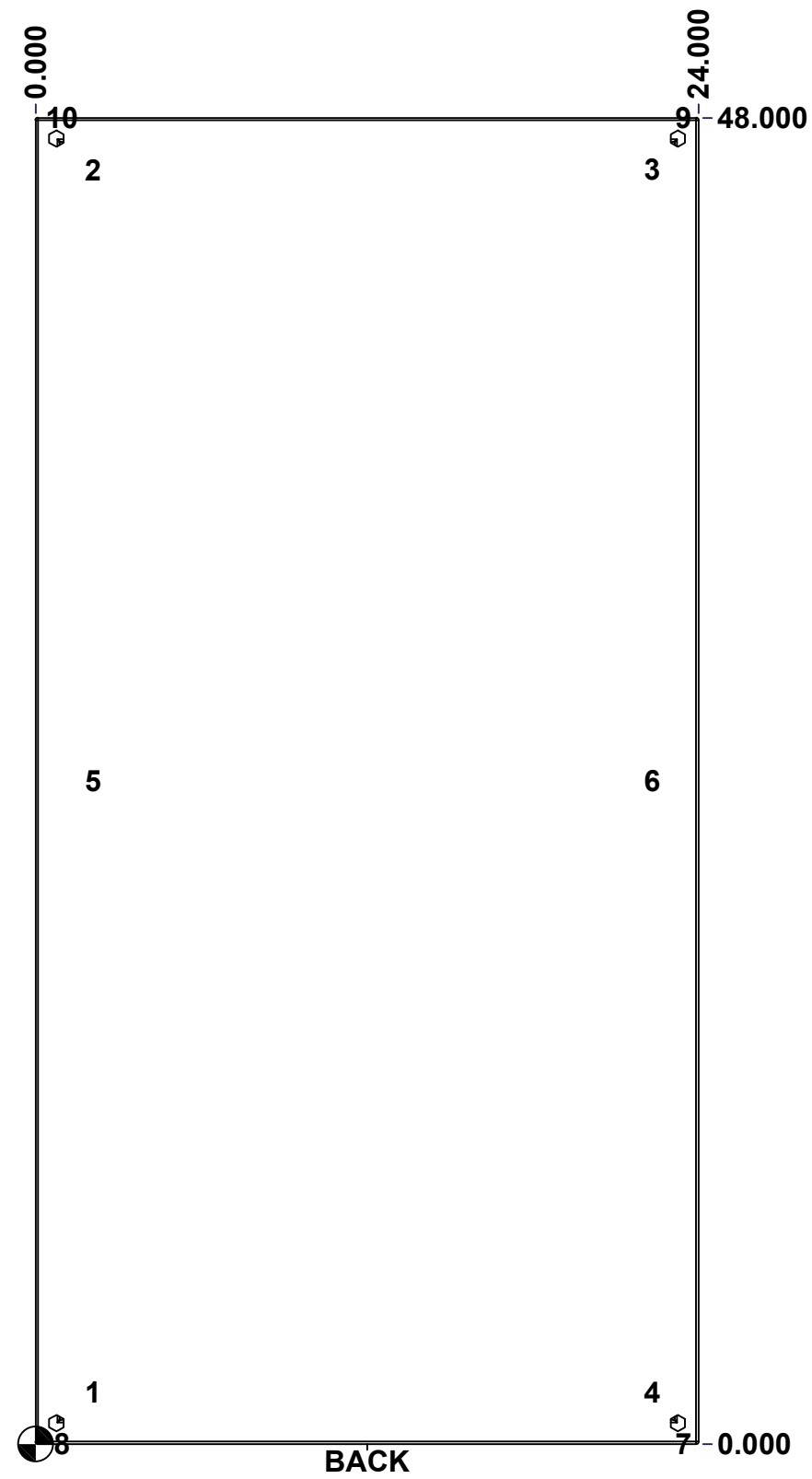

	Description	Status
	5412ESBU 48" x 24" x 8" Body	(NULL)
	Part Number Numéro Pièce	Rev.
	5412ESBU482408THNOIPB	6 0
		16

This drawing is confidential and must not be reproduced or used without the consent of EXM

Ce dessin est confidentiel et ne doit pas être reproduit ou utilisé sans le consentement de EXM

No.	Revisions	Date	By/Par

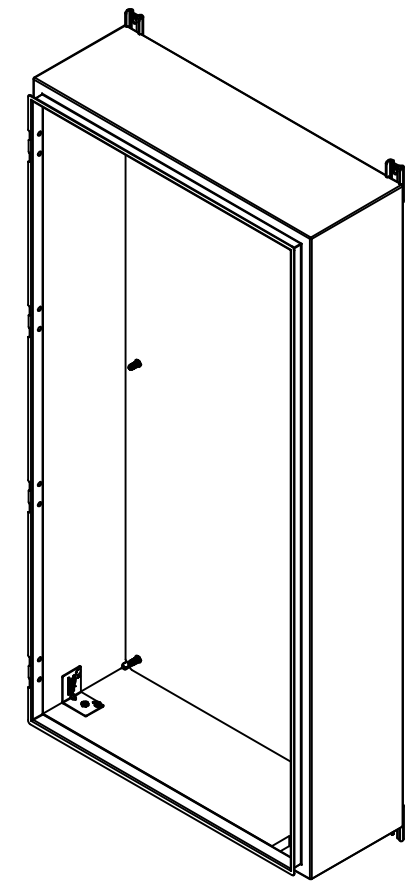

Isometric View



2	885ESMF3-FEET	0	885 ESMF3 Mounting Foot
4	RIVET_NUT_M10_FH_CE	0	Rivet Nut M10 (Low Profile Close End)
4	STK-Q-06660	2	M10 x 16mm Machine Screw
2	885ESMF3-FEET-A	0	885 ESMF3 Mounting Foot (Opened Slot)
1	STK-K-70554	3	5412 ESTH Accessory Kit
1	5412ESBU482408THNOI PI-RS	0	5412ESBU 48" x 24" Right Insulation
1	5412ESBU482408THNOI PI-LS	0	5412ESBU 48" x 24" Left Insulation
1	5412ESBU482408THNOI PI-BT	0	5412ESBU 48" x 24" Top and Bottom Insulation
1	5412ESBU482408THNOI PI-TP	0	5412ESBU 48" x 24" Top and Bottom Insulation
1	5412ESBU482408THNOI PI-B	0	5412ESBU 48" x 24" Back Insulation
4	STK-Q-16055	1	M6 x 18mm Stud (No Paint Cap Required)
1	STK-P-02400S	0	Powder Paint (Asa-61 Grey / Smooth)
6	STK-Q-16005	1	Stud M8 x 35 (No Paint Cap Required)
1	5412ESBU482408THNOI PB-P	0	5412ESBU 48" x 24" x 8" Body Part

Qty	Part Number	Rev	Description
Parts List			

	Tél: (450) 979-4373 Fax: (450) 979-4626 <a href="http://www.exmweb.com">www.exmweb.com</a>	Flatness Aplatissement Max 3.0mm
	Projection 	Customer Client
Drawn By Dessiné Par	BoxCad: BoxCad	Date 13-Apr-23
Material Matière	16 Ga Cold Rolled A1008 CS Type B (1.4mm)	
Color Couleur	Asa-61 Grey	Finish Fini Smooth
Description 5412ESBU 48" x 24" x 8" Body		Detail Rev.
Part Number Numéro Pièce <b>5412ESBU482408THNOIPB</b>		Rev. 7 <b>0</b>

This drawing is confidential and must not be reproduced or used without the consent of EXM

Ce dessin est confidentiel et ne doit pas être reproduit ou utilisé sans le consentement de EXM

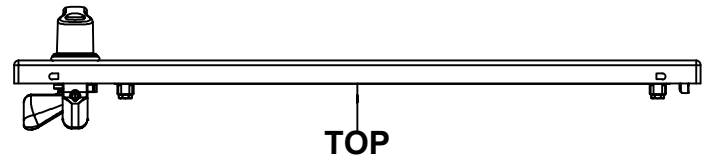

TOP

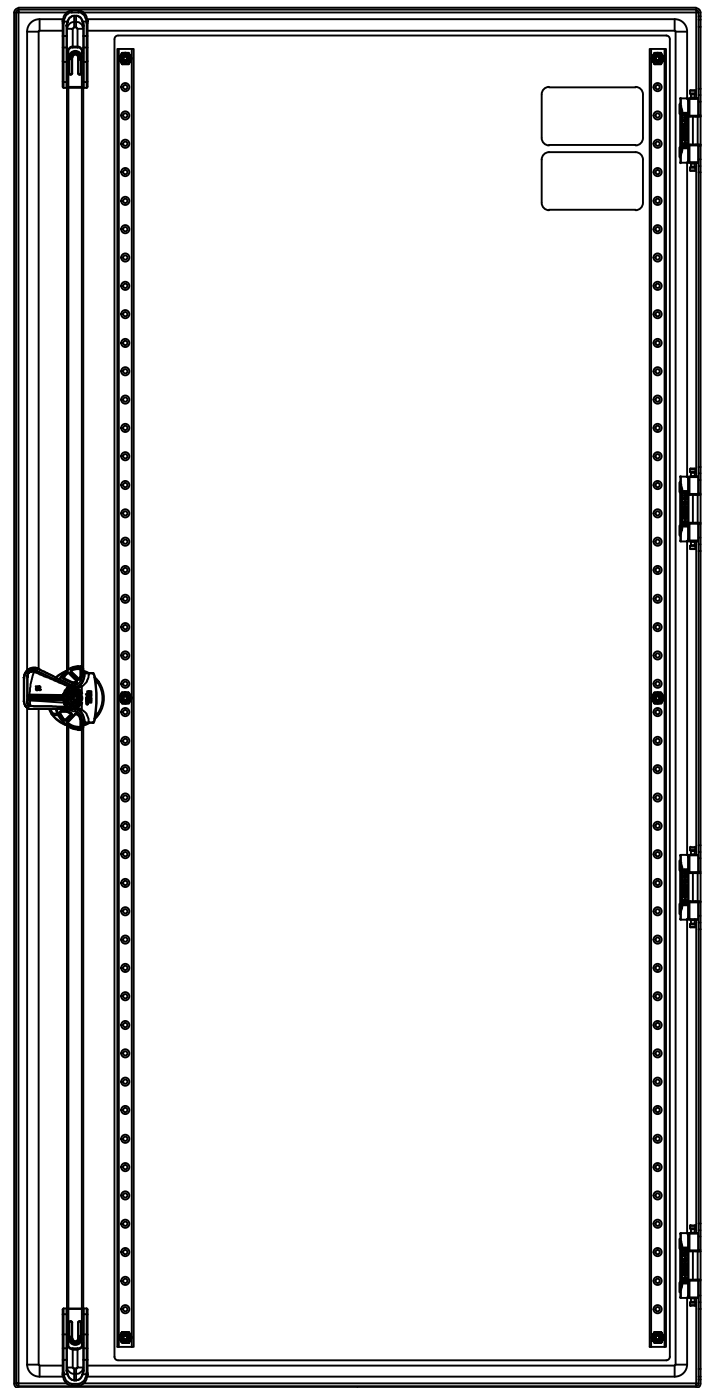

BACK

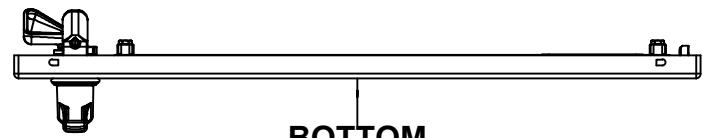

BOTTOM

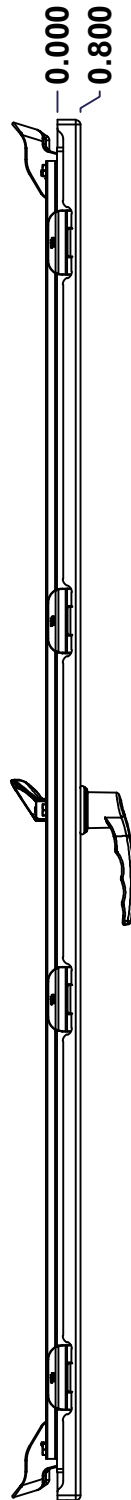

LEFT

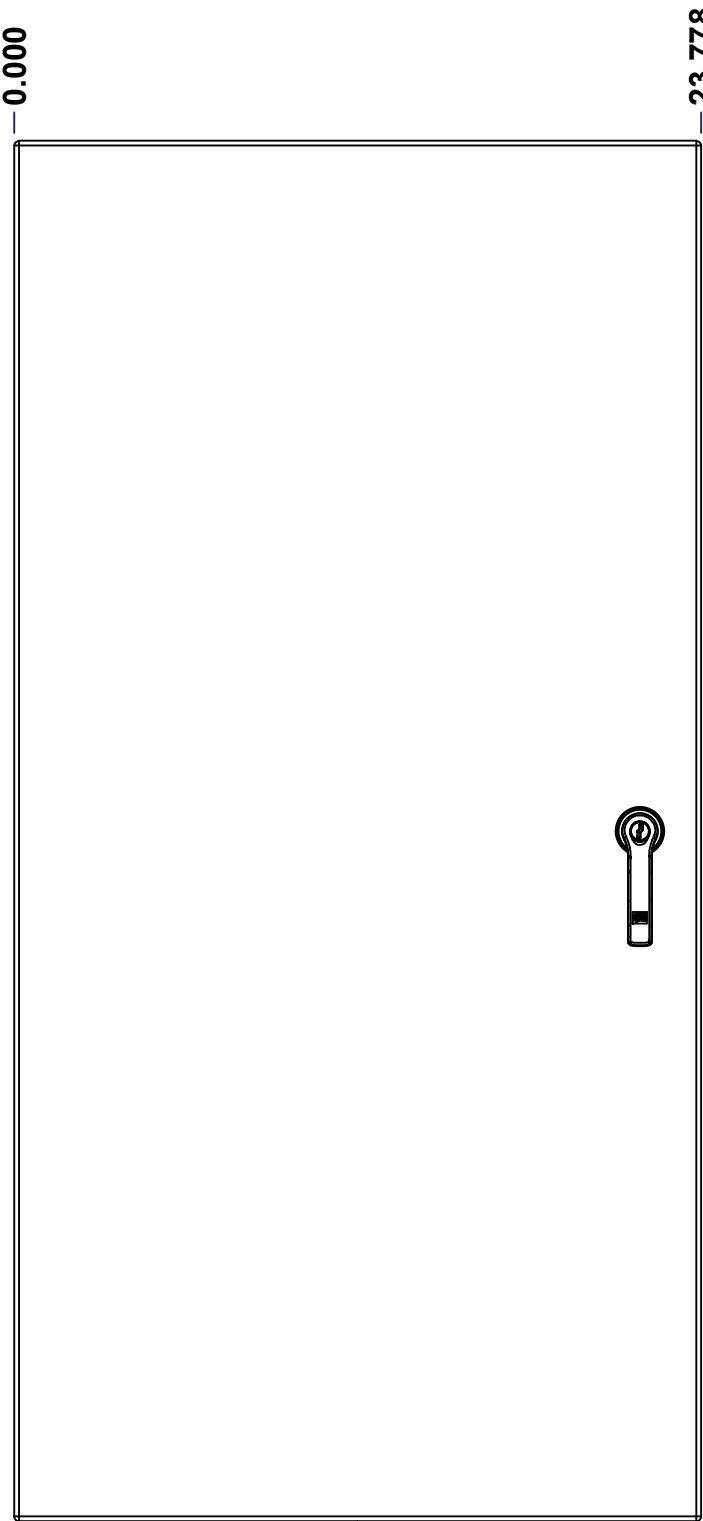

FRONT

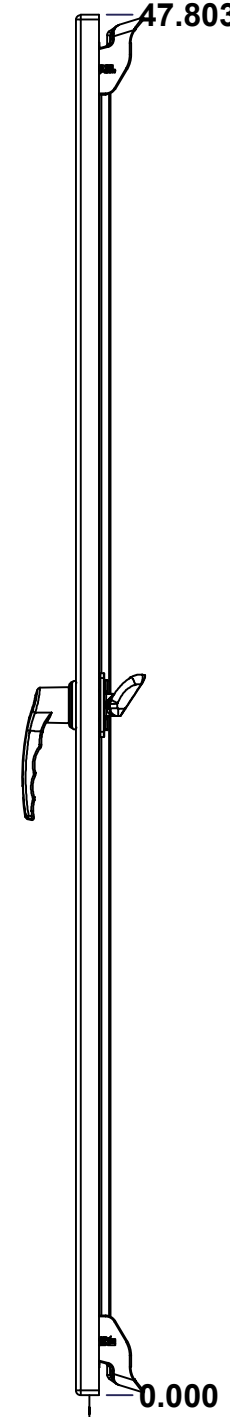

RIGHT

0.000  
0.800

0.000

23.778

47.803

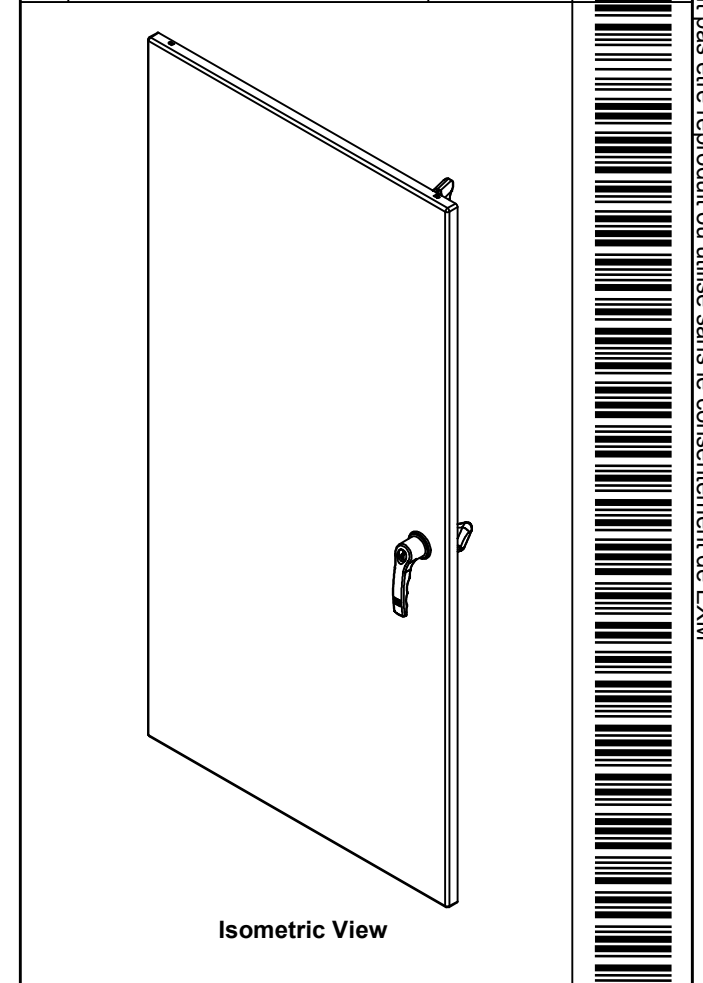

0.000

No.	Revisions	Date	By/Par

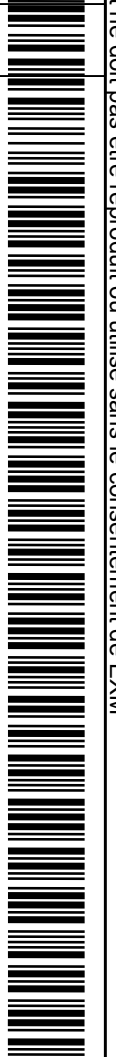

Isometric View



 Tél: (450) 979-4373 Fax: (450) 979-4626 <a href="http://www.exmweb.com">www.exmweb.com</a>		Flatness Aplatissement  Max 3.0mm Projection 
Customer Client	Date	
Drawn By Dessiné Par	BoxCad: BoxCad	Date 13-Apr-23
Material Matière	14 Ga Cold Rolled A1008 CS Type B (1.7mm)	
Color Couleur	Asa-61 Grey	Finish Fini Smooth
Description	Detail Rev.	
5412ESBU 48" x 24" Cover		
Part Number Numéro Pièce	Rev. 8	
SEE BILL OF MATERIAL ON LAST PAGE 5412ESBU482408THNOIPC		0



This drawing is confidential and must not be reproduced or used without the consent of EXM

Ce dessin est confidentiel et ne doit pas être reproduit ou utilisé sans le consentement de EXM

STANDARD FEATURES ARE NOT LISTED IN THIS HOLE TABLE			
HOLE TABLE - FRONT VIEW (CUSTOM FEATURE ONLY)			
CUT-OUT	XDIM	YDIM	DESCRIPTION
1	1.486	1.756	STUD M6 x 18mm (Inside)
2	1.486	46.047	STUD M6 x 18mm (Inside)
3	19.923	46.047	STUD M6 x 18mm (Inside)
4	19.923	1.756	STUD M6 x 18mm (Inside)
5	1.486	23.902	STUD M6 x 18mm (Inside)
6	19.923	23.902	STUD M6 x 18mm (Inside)
7	21.663	42.896	CLOSING BAR STUD (Inside)
8	21.663	4.907	CLOSING BAR STUD (Inside)
-----	-----	-----	-----
9	21.663	23.902	885 ESL2A

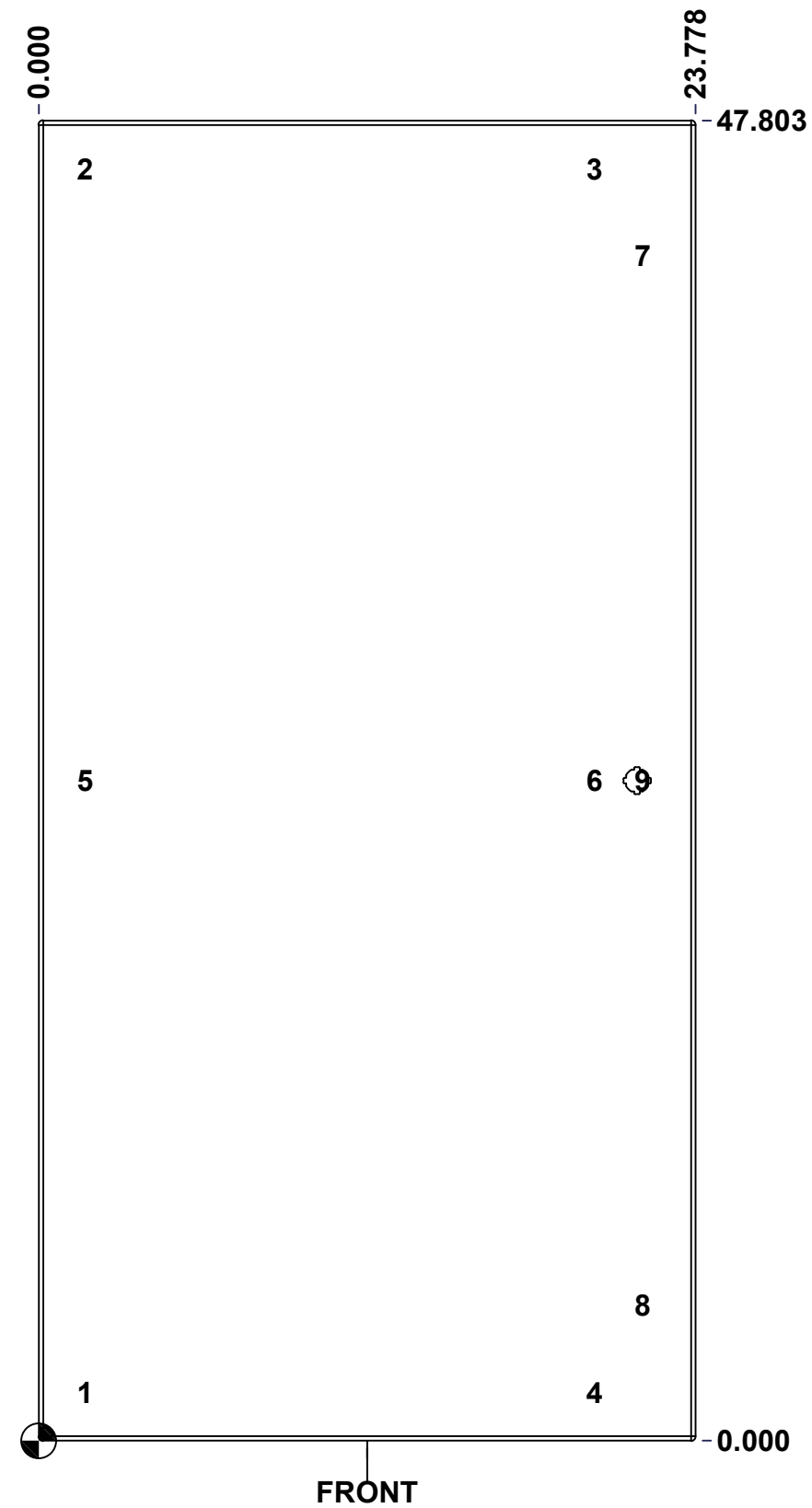

	Description	Status
	5412ESBU 48" x 24" Cover	(NULL)
	Part Number Numéro Pièce	Rev.
	<b>5412ESBU482408THNOIPC</b>	<b>0</b>
		9
		16

This drawing is confidential and must not be reproduced or used without the consent of EXM

Ce dessin est confidentiel et ne doit pas être reproduit ou utilisé sans le consentement de EXM

No.	Revisions	Date	By/Par

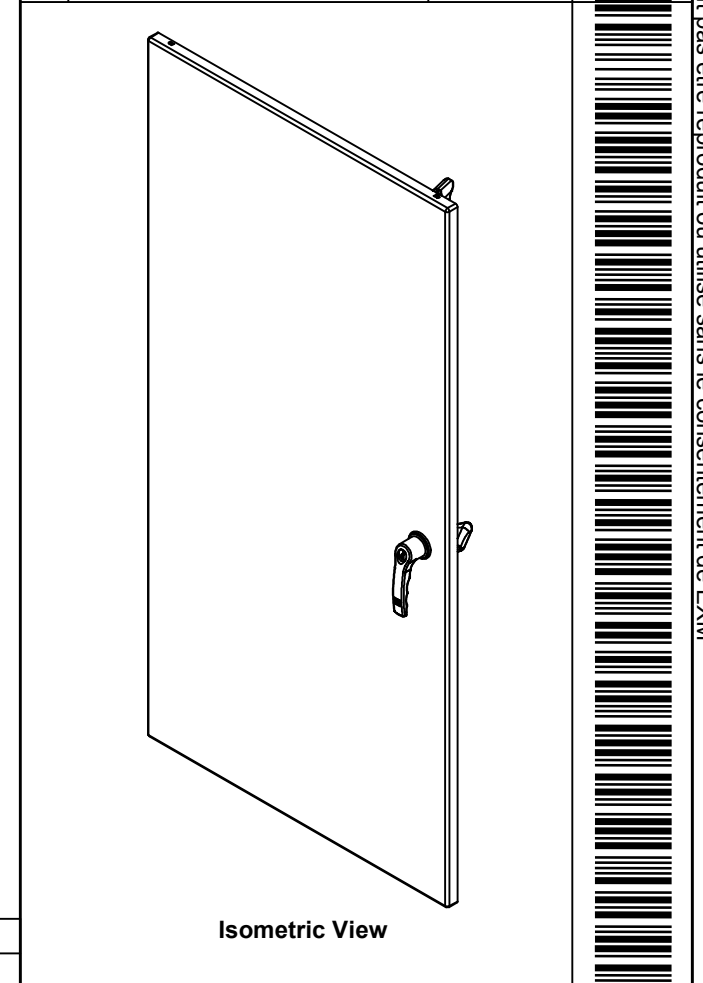

2	STK-Q-90042	4	5412 ES - Cabinet Closing Bar End (Small)
2	STK-Q-45655-48	0	5412 ES - Closing Bar
1	STK-Q-50536	13	5412 ES - Handle Cam Clockwise (Grip 32mm)
1	STK-Q-90051	3	5412 ES - Handle Cam Spacer
1	885 ESL2A	4	5412 ES Key Lock L-Handle (3 Pts)
2	STK-S-00100	0	3.5" x 2" Silver Milar Flexcon Sticker
6	STK-Q-07250	2	M6 x 16mm Collar Nut
2	STK-Q-46020-48	5	5412 ES Vertical Door Stiffener 48"
1	5412ESBU482408THNOI PI-C	0	5412ESBU 48" x 24" Cover Insulation
1	STK-P-02400S	0	Powder Paint (Asa-61 Grey / Smooth)
2	STK-Q-16405	6	Guide Stud - Small (No Paint Cap Required)
6	STK-Q-16055	1	M6 x 18mm Stud (No Paint Cap Required)
4	STK-A-33005	4	5412 ESBU Hinge 180° (Body Part)
1	5412ESBU482408THNOI PG	0	5412ESBU 48" x 24" Cover Gasket Part
1	5412ESBU482408THNOI PC-P	0	5412ESBU 48" x 24" Cover Part

QTY	Part Number	Rev	Description
Parts List			



Tél: (450) 979-4373  
Fax: (450) 979-4626  
[www.exmweb.com](http://www.exmweb.com)

Flatness  
Aplatissement  
Max 3.0mm

Projection

Customer Client

Date

Drawn By  
Dessiné Par BoxCad: BoxCad

Date 13-Apr-23

Material  
Matière 14 Ga Cold Rolled A1008 CS Type B (1.7mm)

Color  
Couleur Asa-61 Grey

Finish  
Fini Smooth

Description

5412ESBU 48" x 24" Cover

Detail Rev.

Part Number  
Numéro Pièce

**5412ESBU482408THNOIPC**

Rev. 10

**0**

16

This drawing is confidential and must not be reproduced or used without the consent of EXM

Ce dessin est confidentiel et ne doit pas être reproduit ou utilisé sans le consentement de EXM

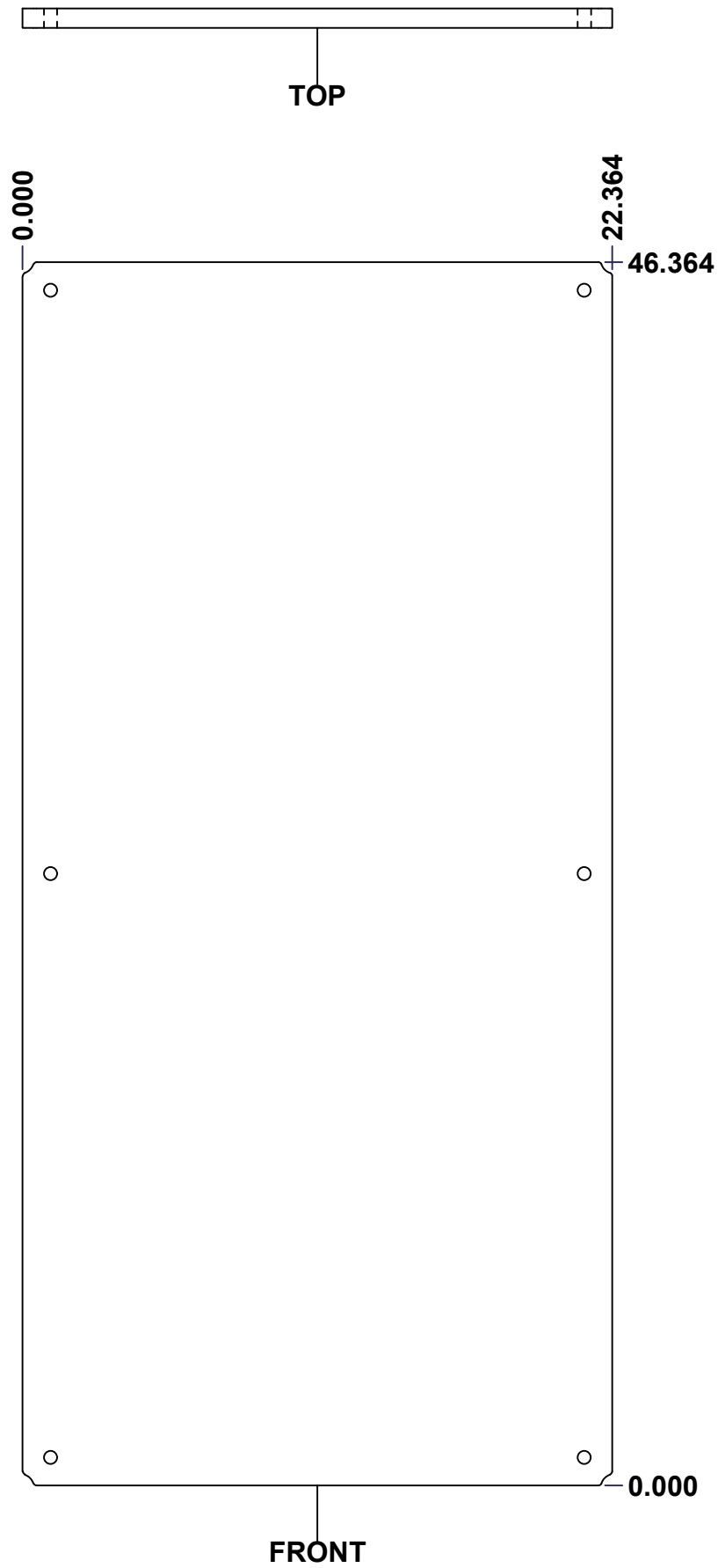

No.	Revisions	Date	By/Par

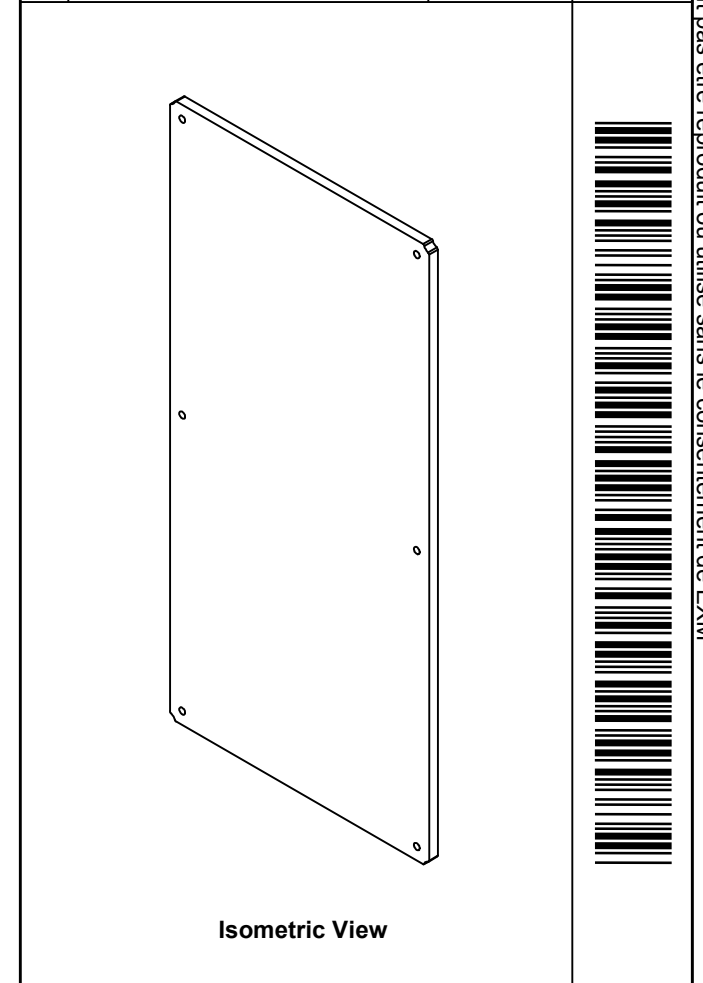

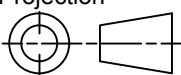
 Tél: (450) 979-4373 Fax: (450) 979-4626 <a href="http://www.exmweb.com">www.exmweb.com</a>		Flatness Aplatissement Max 3.0mm Projection 
Customer Client	Date	
Drawn By Dessiné Par	BoxCad: Patrick Deschenes	Date 23-Jan-07
Material Matière	Polyisocyanurate	
Color Couleur	Aluminum	Finish Fini N/A
Description		Detail Rev.
5412ESBU 48" x 24" Back Insulation		
Part Number Numéro Pièce	Rev.	11
SEE BILL OF MATERIAL ON LAST PAGE 5412ESBU482408THNOIPI-B 0		16

This drawing is confidential and must not be reproduced or used without the consent of EXM

Ce dessin est confidentiel et ne doit pas être reproduit ou utilisé sans le consentement de EXM

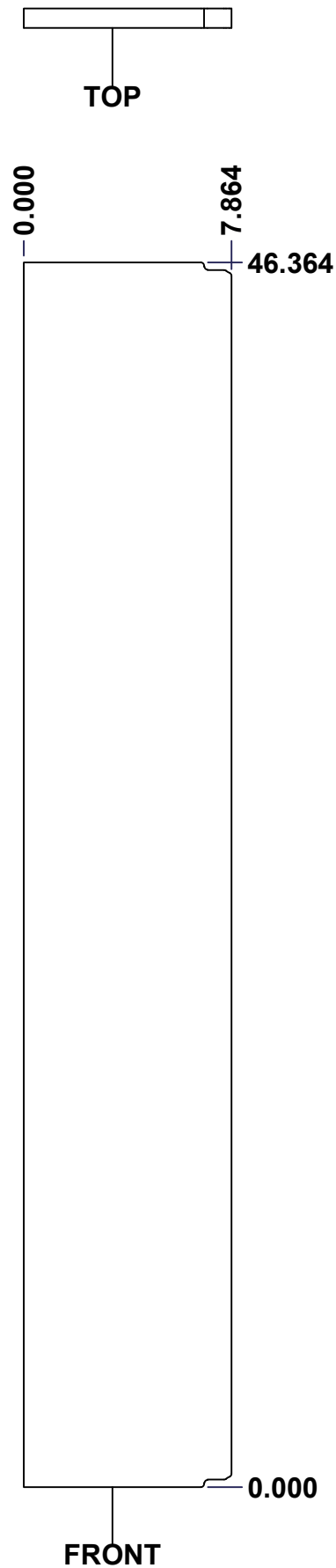

No.	Revisions	Date	By/Par

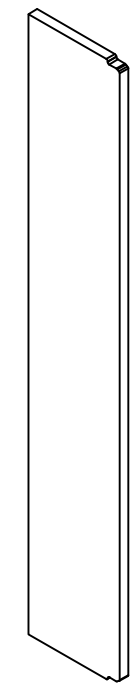

Isometric View

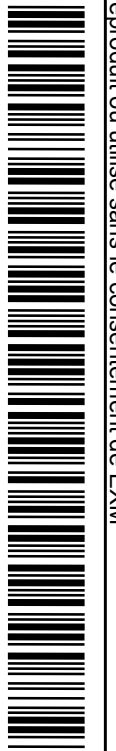

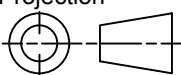
 Tél: (450) 979-4373 Fax: (450) 979-4626 <a href="http://www.exmweb.com">www.exmweb.com</a>		Flatness Aplatissement Max 3.0mm
Projection 		Date 23-Jan-07
Customer Client	Date	
Drawn By Dessiné Par	BoxCad: Patrick Deschenes	Date 23-Jan-07
Material Matière	Polyisocyanurate	
Color Couleur	Aluminum	Finish Fini N/A
Description 5412ESBU 48" x 24" Left Insulation		Detail Rev.
Part Number Numéro Pièce	Rev.	12

SEE BILL OF MATERIAL ON LAST PAGE 5412ESBU482408THNOIPI-LS 0 16

This drawing is confidential and must not be reproduced or used without the consent of EXM

Ce dessin est confidentiel et ne doit pas être reproduit ou utilisé sans le consentement de EXM

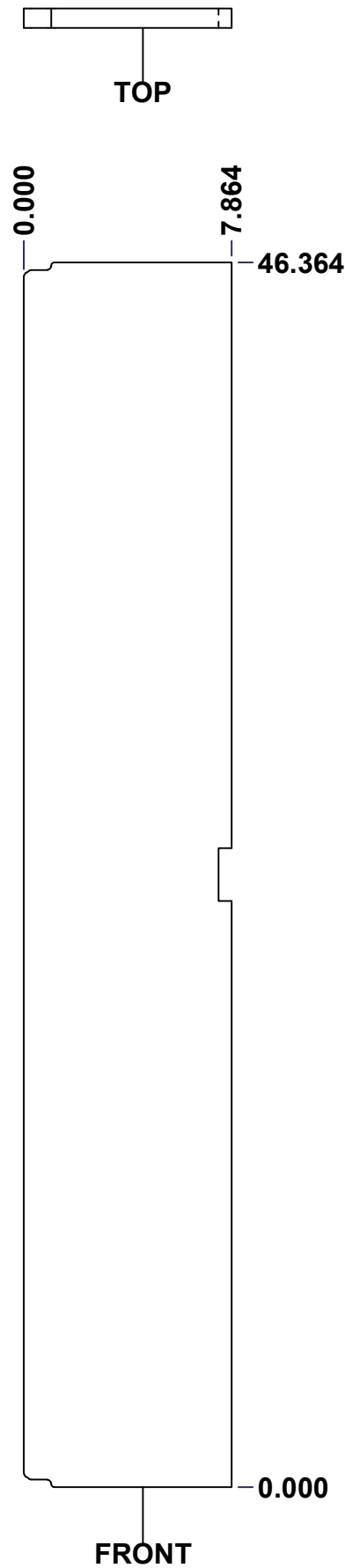

No.	Revisions	Date	By/Par

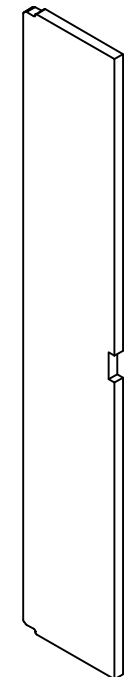

Isometric View

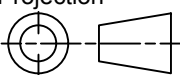

 Tél: (450) 979-4373 Fax: (450) 979-4626 <a href="http://www.exmweb.com">www.exmweb.com</a>		Flatness Aplatissement Max 3.0mm
Customer Client		Projection 
Drawn By / Dessiné Par: BoxCad: Patrick Deschenes		Date: 23-Jan-07
Material / Matière: Polyisocyanurate		
Color / Couleur: Aluminum	Finish / Fini: N/A	
Description: 5412ESBU 48" x 24" Right Insulation		Detail Rev.
Part Number / Numéro Pièce: 5412ESBU482408THNOIP-RS 0		Rev. 13

SEE BILL OF MATERIAL ON LAST PAGE 5412ESBU482408THNOIP-RS 0 16

This drawing is confidential and must not be reproduced or used without the consent of EXM

Ce dessin est confidentiel et ne doit pas être reproduit ou utilisé sans le consentement de EXM

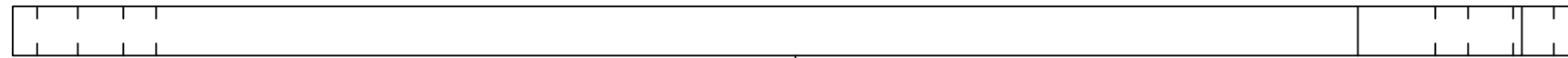

TOP

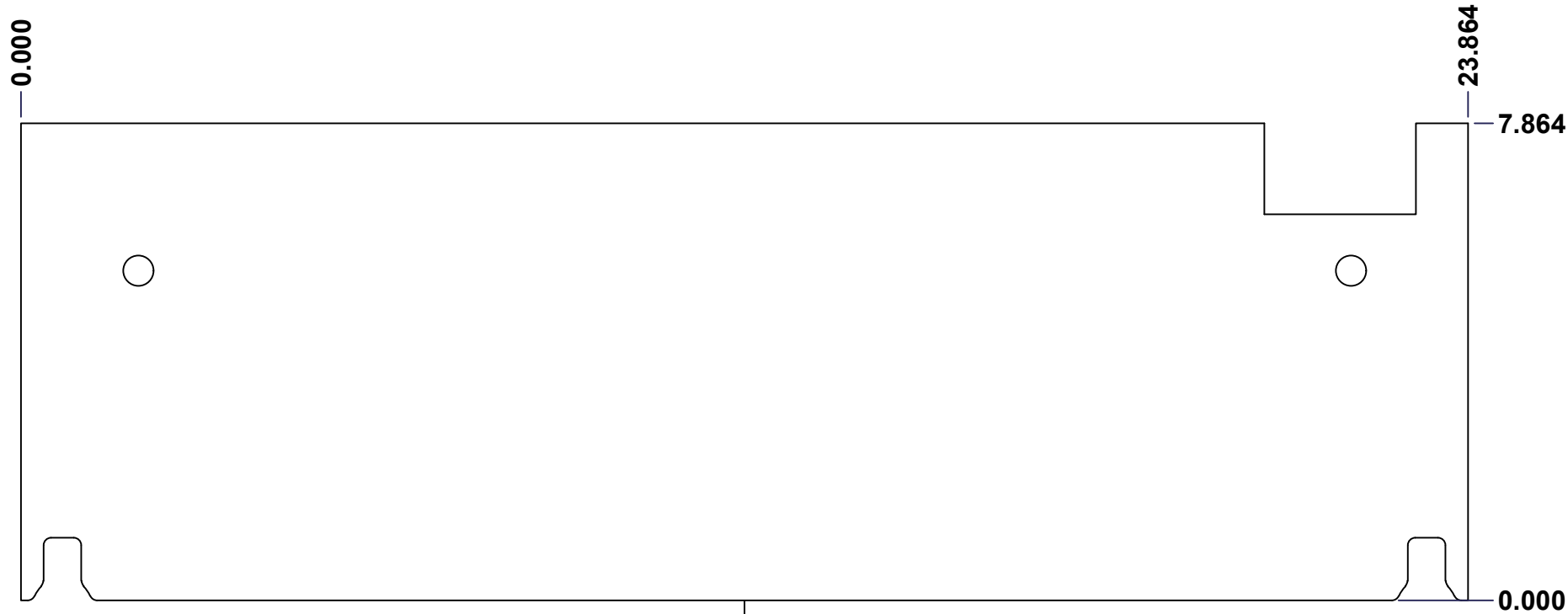

FRONT

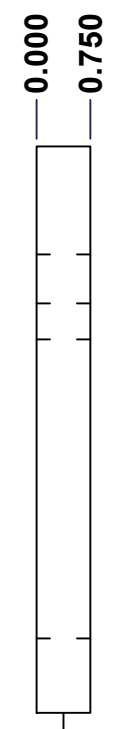

RIGHT

No.	Revisions	Date	By/Par

**Isometric View**

Tél: (450) 979-4373 Fax: (450) 979-4626 <a href="http://www.exmweb.com">www.exmweb.com</a>		Flatness Aplatissement	
		Max 3.0mm	
Customer Client		Date	
Drawn By Dessiné Par		Date	
Material Matière		Polyisocyanurate	
Color Couleur	Aluminum	Finish Fini	N/A
Description 5412ESBU 48" x 24" Top and Bottom Insulation			Detail Rev.
Part Number Numéro Pièce		Rev.	14

This drawing is confidential and must not be reproduced or used without the consent of EXM

Ce dessin est confidentiel et ne doit pas être reproduit ou utilisé sans le consentement de EXM

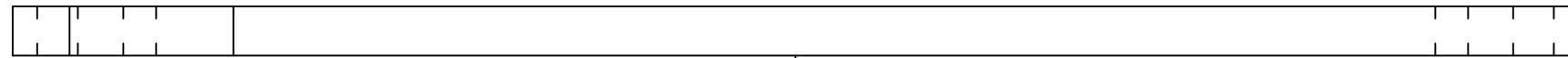

TOP

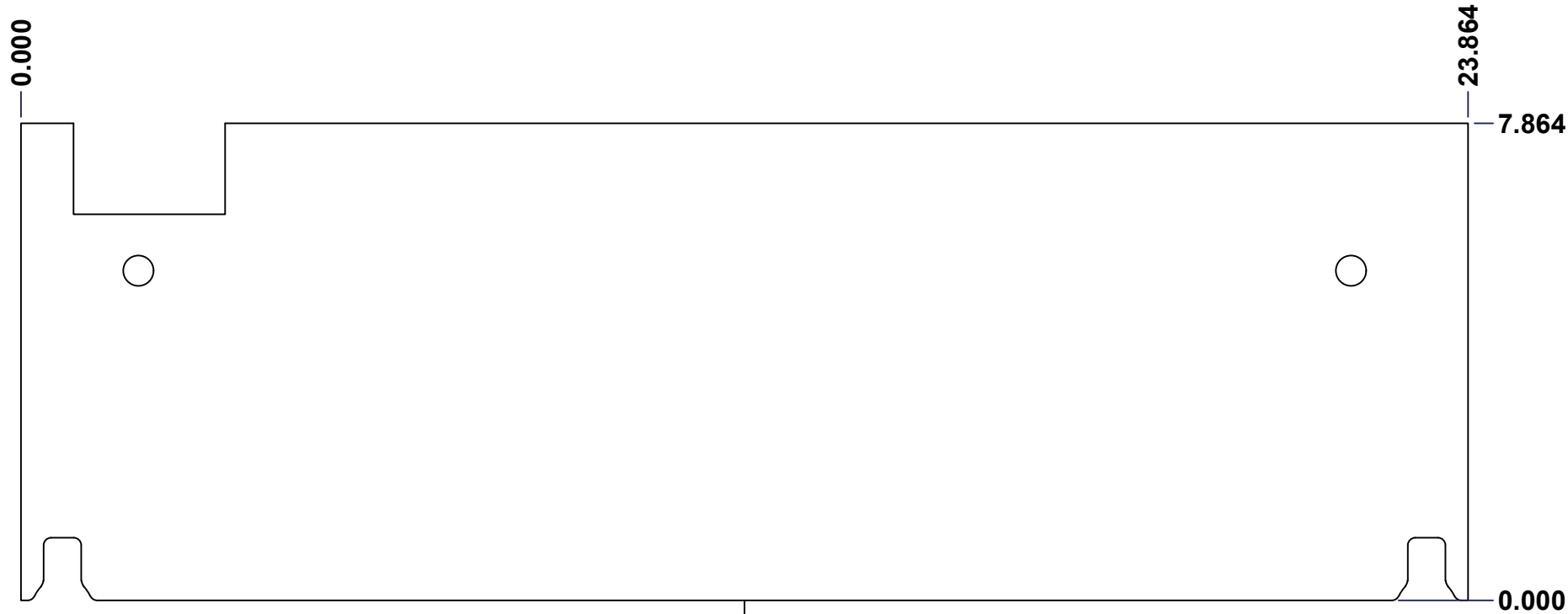

FRONT

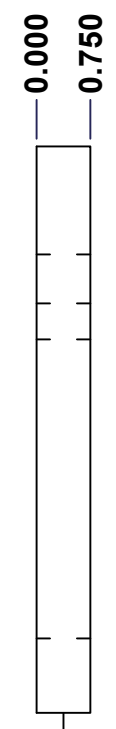

RIGHT

No.	Revisions	Date	By/Par

**Isometric View**

Tél: (450) 979-4373 Fax: (450) 979-4626 <a href="http://www.exmweb.com">www.exmweb.com</a>		Flatness Aplatissement	
		Max 3.0mm	
Customer Client		Date	
Drawn By Dessiné Par		Date	
Material Matière		Polyisocyanurate	
Color Couleur		Finish Fini	
Description		Detail Rev.	
Part Number Numéro Pièce		Rev.	
SEE BILL OF MATERIAL ON LAST PAGE <b>5412ESBU482408THNOIPI-BT 0</b>		15	
		16	

This drawing is confidential and must not be reproduced or used without the consent of EXM

Ce dessin est confidentiel et ne doit pas être reproduit ou utilisé sans le consentement de EXM

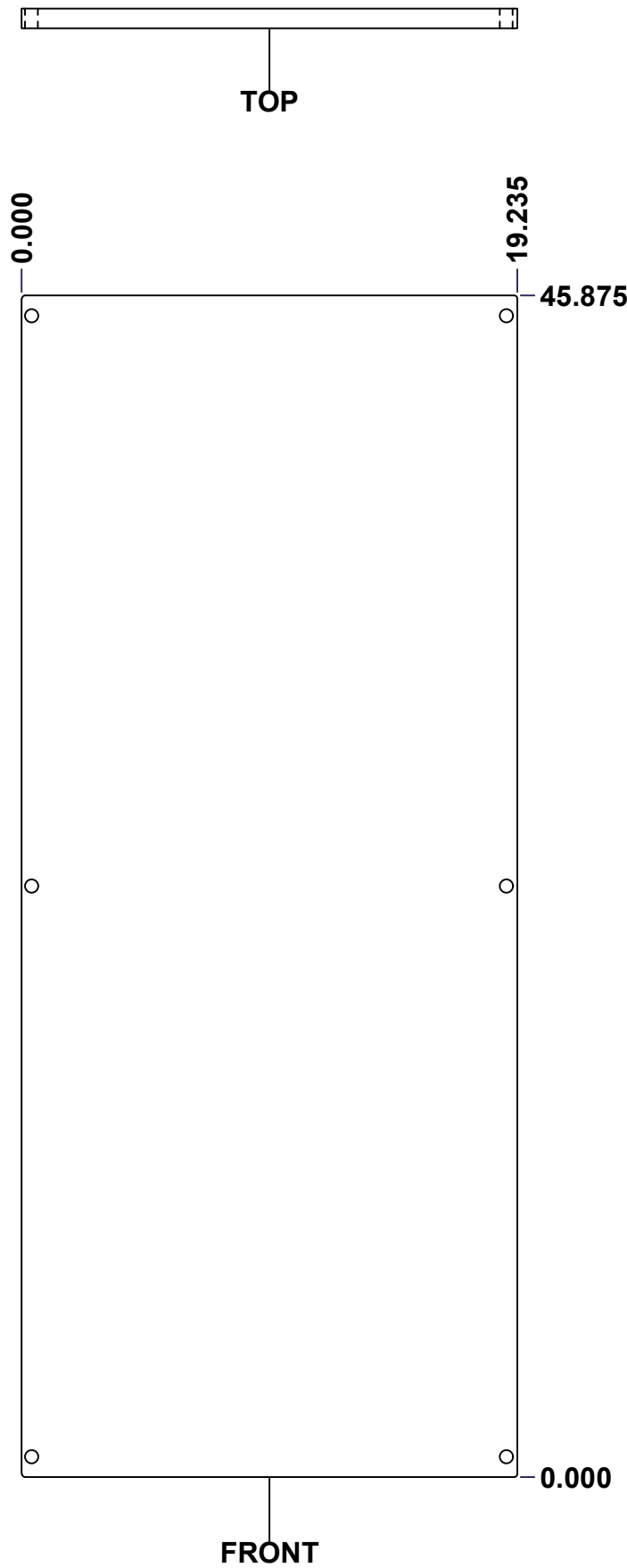

No.	Revisions	Date	By/Par

**Isometric View**

<p>Tél: (450) 979-4373 Fax: (450) 979-4626 <a href="http://www.exmweb.com">www.exmweb.com</a></p>		Flatness Aplatissement	
		Max 3.0mm	
Customer Client		Date	
Drawn By Dessiné Par BoxCad: Patrick Deschenes		Date 23-Jan-07	
Material Matière Polyisocyanurate			
Color Couleur Aluminum		Finish Fini N/A	
Description 5412ESBU 48" x 24" Cover Insulation			Detail Rev.
Part Number Numéro Pièce 5412ESBU482408THNOIP-C		Rev.	16
SEE BILL OF MATERIAL ON LAST PAGE		0	16