

This drawing is confidential and must not be reproduced or used without the consent of EXM

Ce dessin est confidentiel et ne doit pas être reproduit ou utilisé sans le consentement de EXM

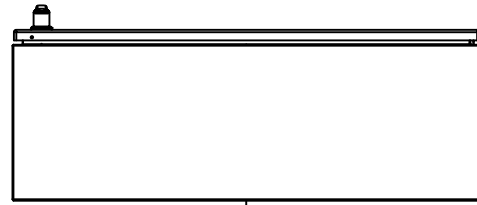

TOP

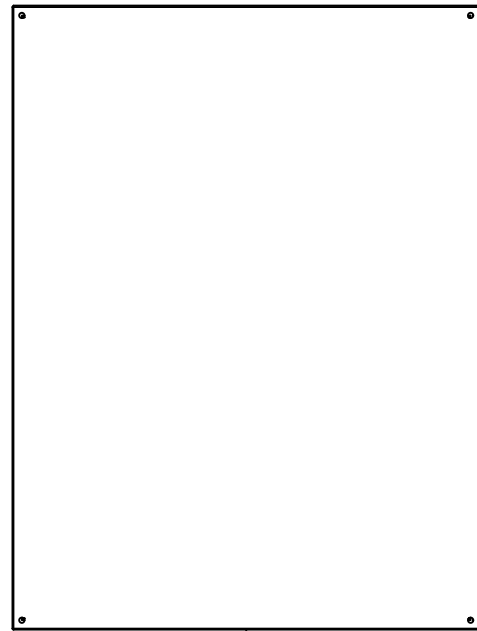

BACK

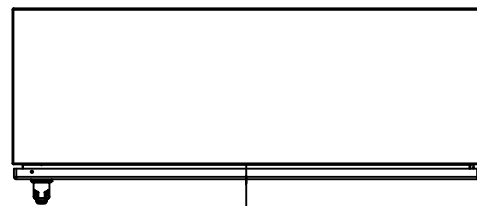

BOTTOM

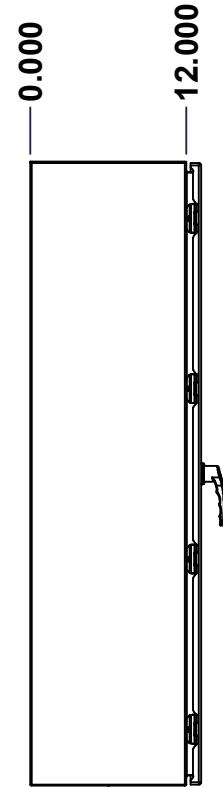

LEFT

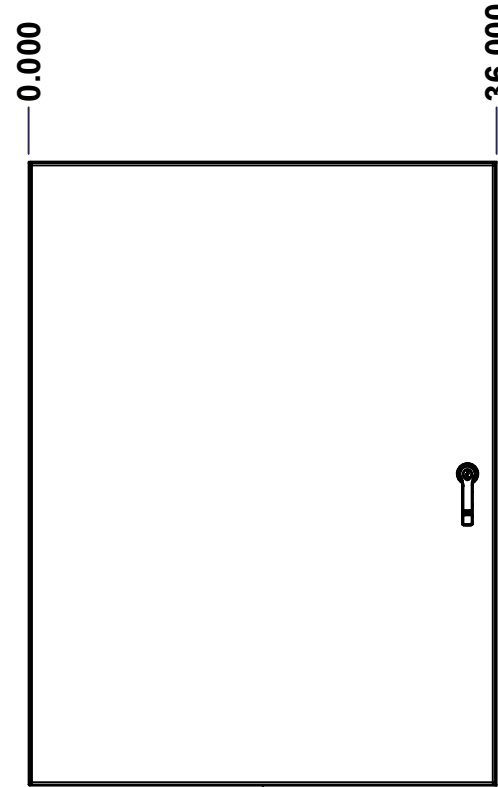

FRONT

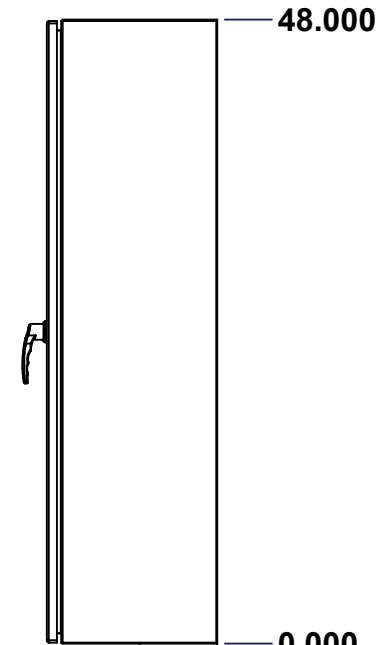

RIGHT

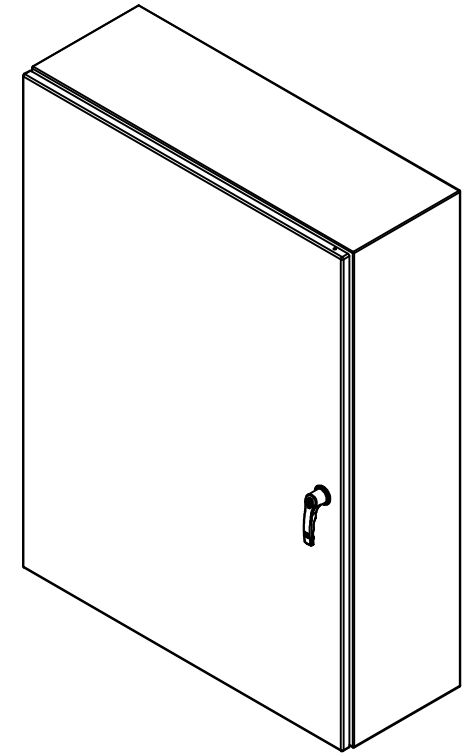

Isometric View

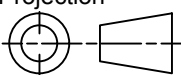

No.	Revisions	Date	By/Par

 Tél: (450) 979-4373 Fax: (450) 979-4626 www.exmweb.com		Flatness Aplatissement Max 3.0mm Projection 
Customer Client	Date	
Drawn By Dessiné Par	BoxCad: BoxCad	Date 12-Mar-14
Material Matière	14 Ga Cold Rolled A1008 CS Type B (1.7mm)	
Color Couleur	Asa-61 Grey	Finish Fini Smooth
Description 5412ESBU 48" x 36" x 12" Assembly		Detail Rev.
Part Number Numéro Pièce	5412ESBU483612	Rev. 1 0

SEE BILL OF MATERIAL ON LAST PAGE

This drawing is confidential and must not be reproduced or used without the consent of EXM

Ce dessin est confidentiel et ne doit pas être reproduit ou utilisé sans le consentement de EXM

NOTE	
ITEM	DESCRIPTION
1	NEMA 4/12 Enclosure
2	C/W Standard ground studs on box and cover
3	C/W Standard door stiffener
4	C/W Standard inner panel (Included)
5	C/W Standard inner panel mounting studs

No.	Revisions	Date	By/Par

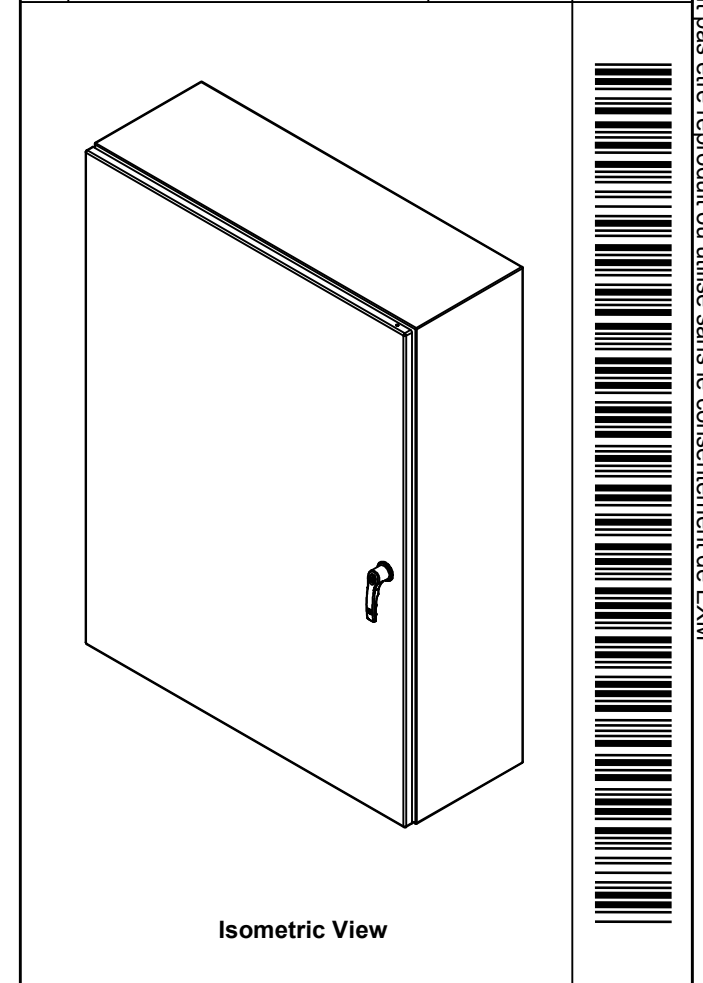

PACKING		
ITEM	QTY	DESCRIPTION
Cardboard sleeve	2	Top and Bottom
Cardboard strip	2	Between back of enclosure and inner panel
Plastic bag	1	To protect cover surface and inside gasket
Cardboard corner	4	To reinforced for the plastic strap tightening
Plastic strap - Black	2	To Squeeze the 2 cardboard sleeve together
Packaging label	3	White label with PN
Plastic strap- Green	2	To secure the enclosure to the wood pallet
Wood Pallet	1	2" deeper and 3" larger than enclosure size

1	881 SP4836G	0	881 SP - Inner Panel
4	STK-K-01320	0	5412 ES Inner Panel Accessory Kit
1	STK-K-01800	5	5412 ES Accessory Kit
1	5412ESBU483612C	0	5412ESBU 48" x 36" Cover
1	5412ESBU483612B	0	5412ESBU 48" x 36" x 12" Body
8	STK-Q-04050-08	0	M6 x 8mm Hexagon Socket Head Machine Screw
Qty	Part Number	Rev	Description
Parts List			

	Tél: (450) 979-4373 Fax: (450) 979-4626 www.exmweb.com	Flatness Aplatissement Max 3.0mm Projection
	Customer Client Drawn By Dessiné Par Material Matière	Date Date BoxCad: BoxCad 14 Ga Cold Rolled A1008 CS Type B (1.7mm)
		Finish Fini Detail Rev. Rev. 2 0

This drawing is confidential and must not be reproduced or used without the consent of EXM

Ce dessin est confidentiel et ne doit pas être reproduit ou utilisé sans le consentement de EXM

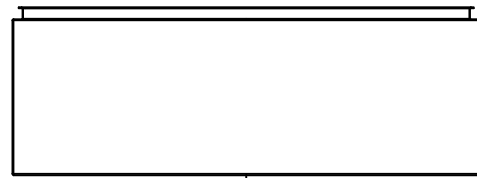

TOP

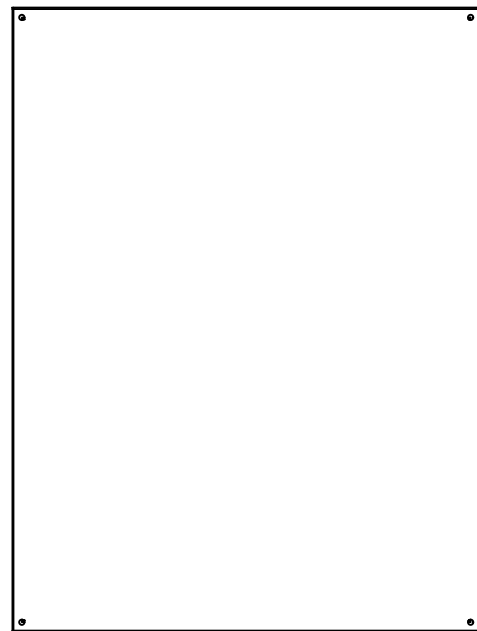

BACK

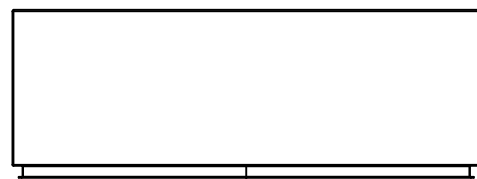

BOTTOM

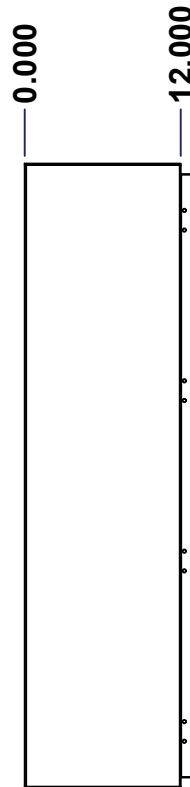

LEFT

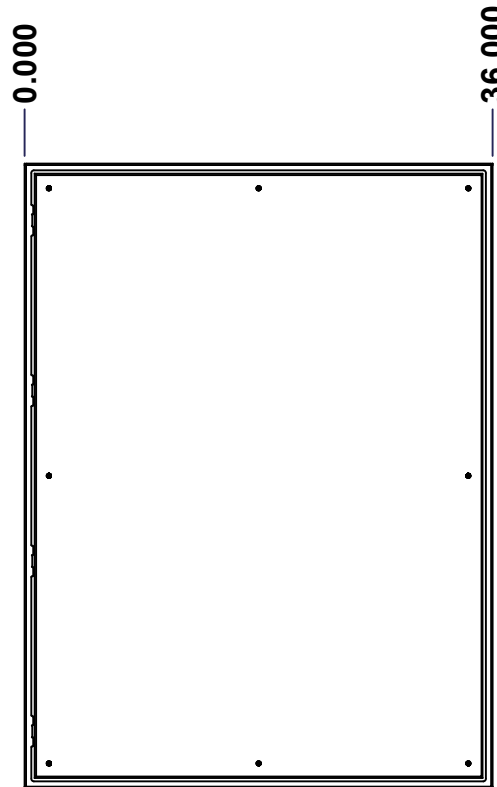

FRONT

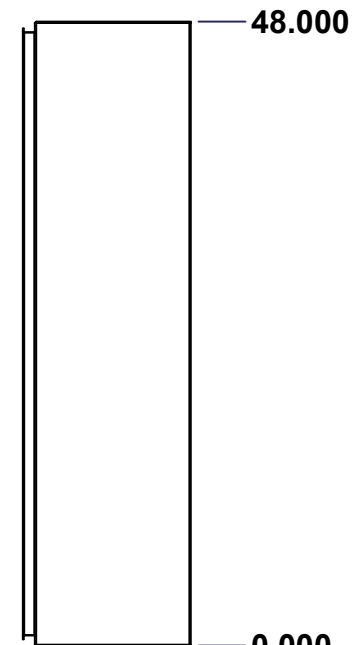

RIGHT

No.	Revisions	Date	By/Par

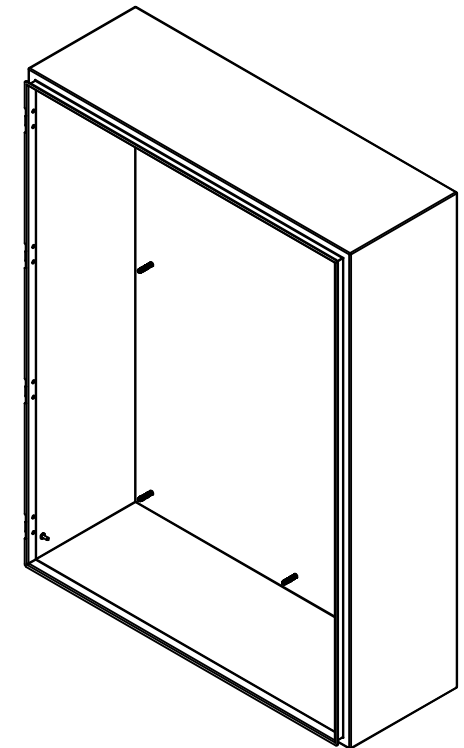

Isometric View



Tél: (450) 979-4373
 Fax: (450) 979-4626
www.exmweb.com

Flatness
Aplatissement

Max 3.0mm

Projection

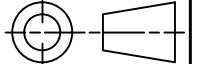

Customer Client	Date
Drawn By / Dessiné Par: BoxCad: BoxCad	Date: 12-Mar-14
Material / Matière: 14 Ga Cold Rolled A1008 CS Type B (1.7mm)	

Color / Couleur: Asa-61 Grey	Finish / Fini: Smooth
------------------------------	-----------------------

Description: 5412ESBU 48" x 36" x 12" Body	Detail Rev.
--	-------------

Part Number / Numéro Pièce: 5412ESBU483612B	Rev. 0	3	9
---	--------	---	---

SEE BILL OF MATERIAL ON LAST PAGE

This drawing is confidential and must not be reproduced or used without the consent of EXM

Ce dessin est confidentiel et ne doit pas être reproduit ou utilisé sans le consentement de EXM

STANDARD FEATURES ARE NOT LISTED IN THIS HOLE TABLE			
HOLE TABLE - LEFT VIEW (CUSTOM FEATURE ONLY)			
CUT-OUT	XDIM	YDIM	DESCRIPTION
1	10.500	2.000	GND STUD M6 x 16mm (Inside)

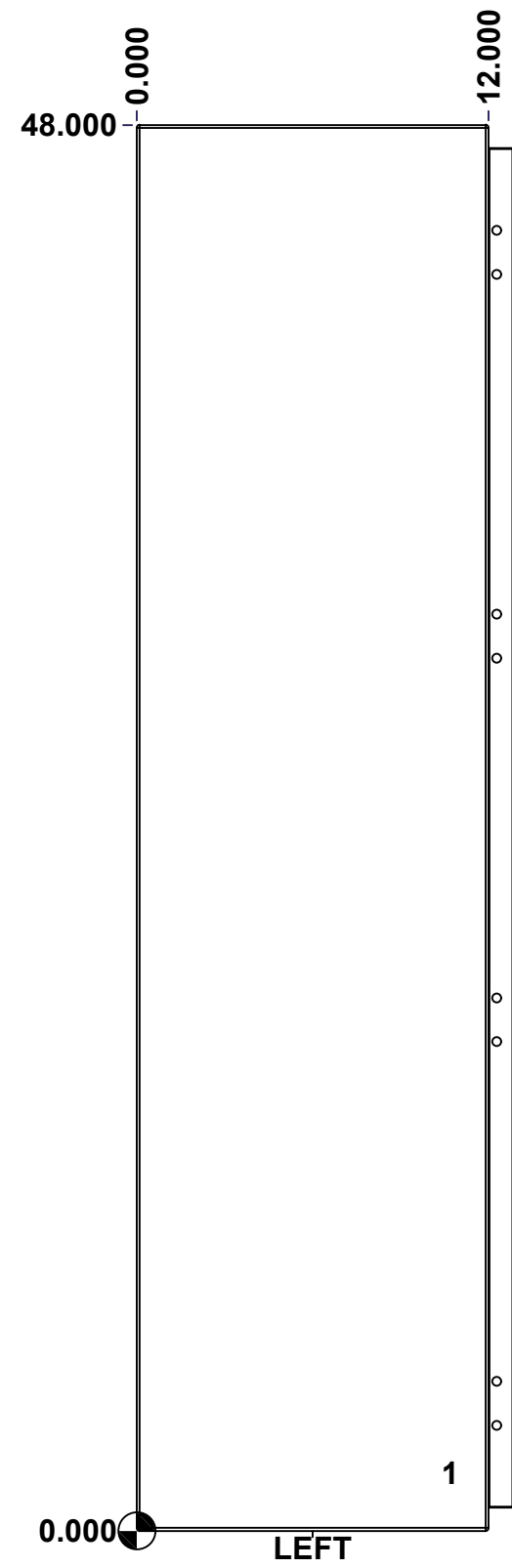

	Description	Status	
	5412ESBU 48" x 36" x 12" Body	(NULL)	
	Part Number Numéro Pièce	Rev.	4
	5412ESBU483612B	0	9

This drawing is confidential and must not be reproduced or used without the consent of EXM

Ce dessin est confidentiel et ne doit pas être reproduit ou utilisé sans le consentement de EXM

STANDARD FEATURES ARE NOT LISTED IN THIS HOLE TABLE

HOLE TABLE - BACK VIEW (CUSTOM FEATURE ONLY)

CUT-OUT	XDIM	YDIM	DESCRIPTION
1	1.875	1.875	IP STUD M8 x 35mm (Inside)
2	1.875	46.125	IP STUD M8 x 35mm (Inside)
3	34.125	46.125	IP STUD M8 x 35mm (Inside)
4	34.125	1.875	IP STUD M8 x 35mm (Inside)
5	1.875	24.000	IP STUD M8 x 35mm (Inside)
6	34.125	24.000	IP STUD M8 x 35mm (Inside)
7	18.000	1.875	IP STUD M8 x 35mm (Inside)
8	18.000	46.125	IP STUD M8 x 35mm (Inside)

9	35.250	0.750	RND Ø0.390
10	35.250	47.250	RND Ø0.390
11	0.750	47.250	RND Ø0.390
12	0.750	0.750	RND Ø0.390

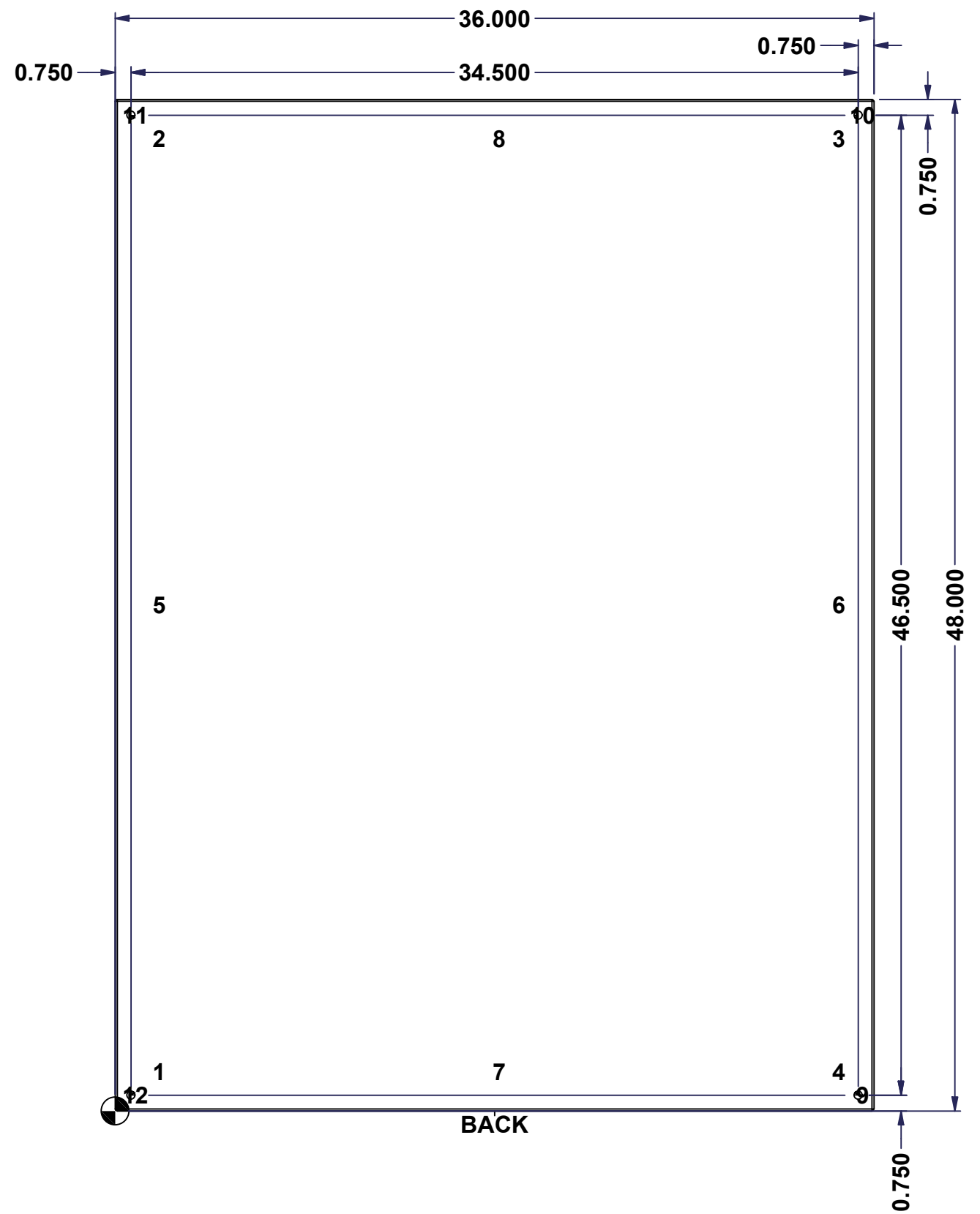

	Description	Status	
	5412ESBU 48" x 36" x 12" Body	(NULL)	
	Part Number	Rev.	5
	Numéro Pièce	0	9
5412ESBU483612B			

This drawing is confidential and must not be reproduced or used without the consent of EXM

Ce dessin est confidentiel et ne doit pas être reproduit ou utilisé sans le consentement de EXM

No.	Revisions	Date	By/Par

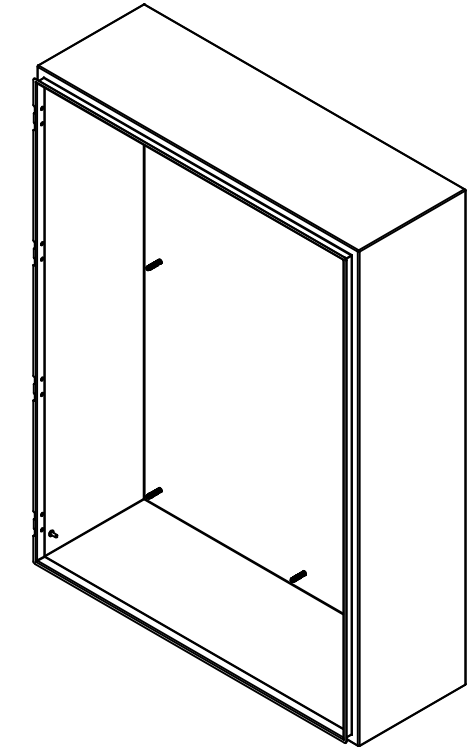

Isometric View

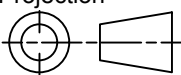

 Tél: (450) 979-4373 Fax: (450) 979-4626 www.exmweb.com		Flatness Aplatissement Max 3.0mm Projection 
Customer Client	Date	
Drawn By Dessiné Par	BoxCad: BoxCad	Date 12-Mar-14
Material Matière	14 Ga Cold Rolled A1008 CS Type B (1.7mm)	
Color Couleur	Asa-61 Grey	Finish Fini Smooth
Description		Detail Rev.
5412ESBU 48" x 36" x 12" Body		
Part Number Numéro Pièce	Rev.	6
5412ESBU483612B	0	9

Qty	Part Number	Rev	Description
1	STK-Q-16080	0	Ground Stud M6 x 16mm Steel
1	STK-P-02400S	0	Powder Paint (Asa-61 Grey / Smooth)
8	STK-Q-16005	1	Stud M8 x 35 (No Paint Cap Required)
1	5412ESBU483612B-P	0	5412ESBU 48" x 36" x 12" Body Part
Parts List			

This drawing is confidential and must not be reproduced or used without the consent of EXM

Ce dessin est confidentiel et ne doit pas être reproduit ou utilisé sans le consentement de EXM

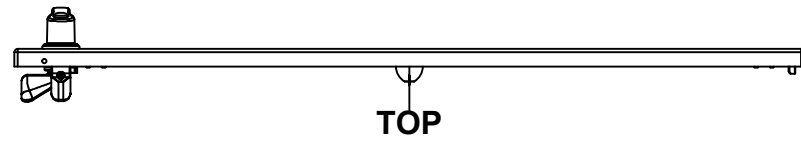

TOP

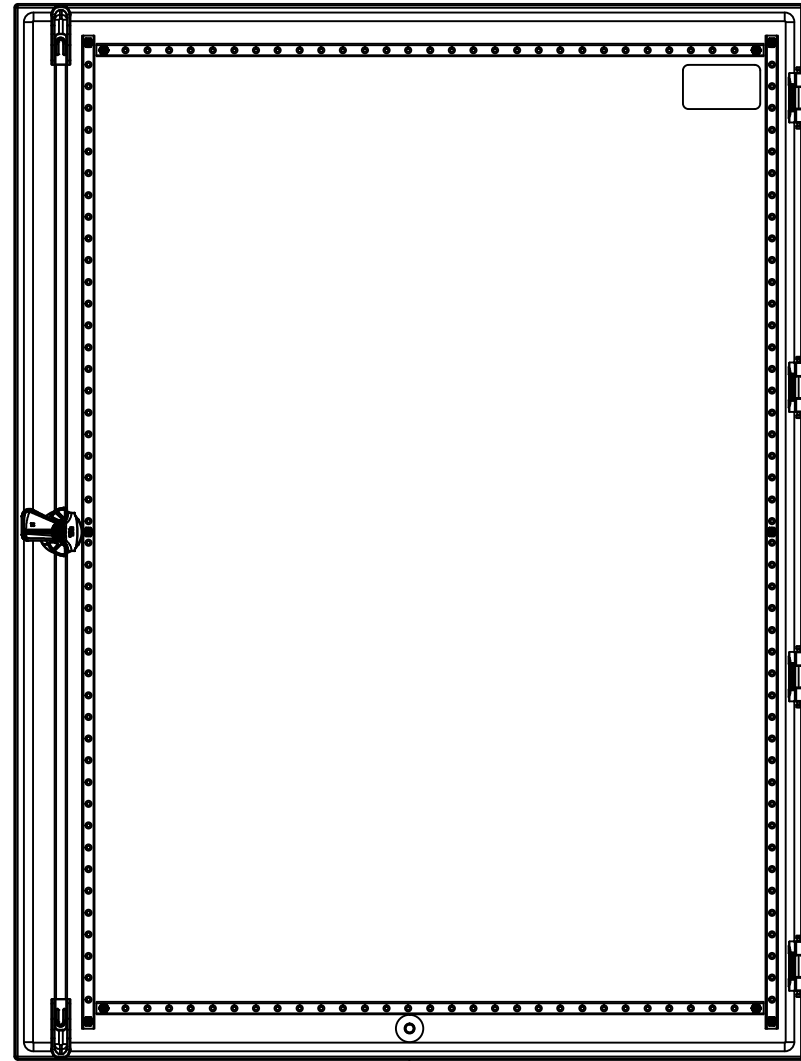

BACK

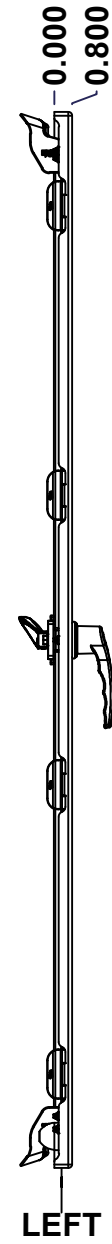

LEFT

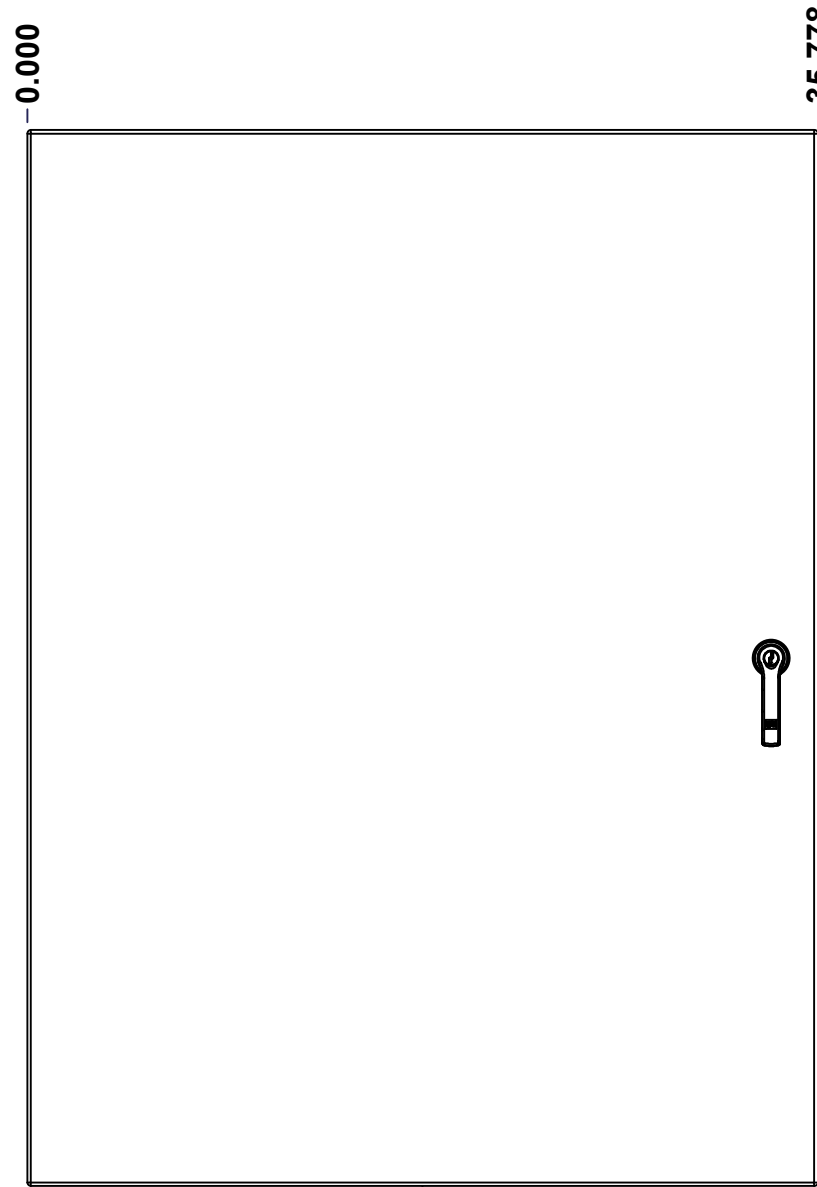

FRONT

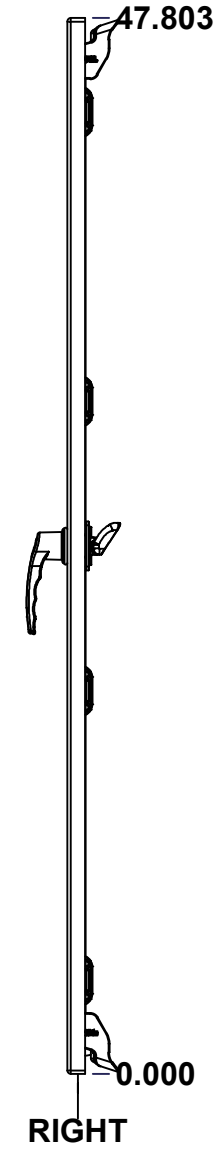

RIGHT

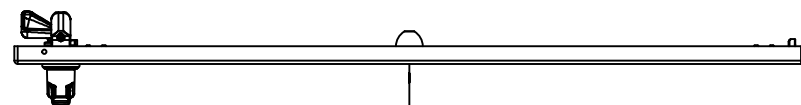

BOTTOM

No.	Revisions	Date	By/Par

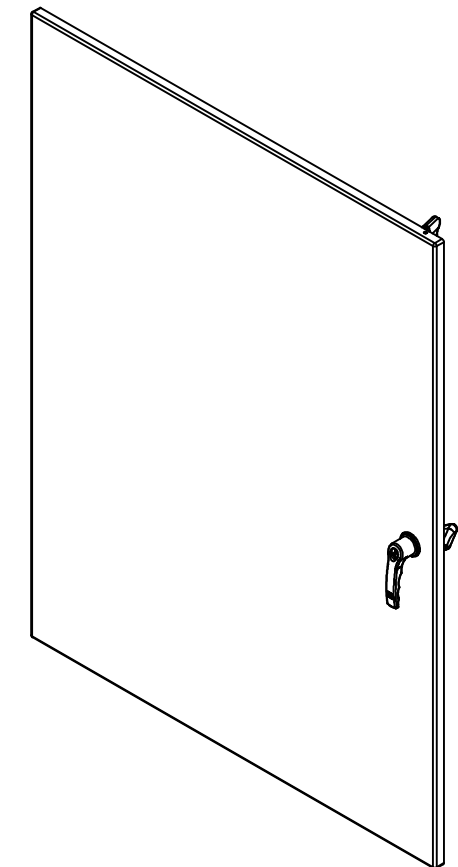

Isometric View

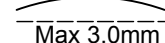
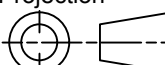

 Tél: (450) 979-4373 Fax: (450) 979-4626 www.exmweb.com		Flatness Aplatissement  Max 3.0mm Projection 
Customer Client	Date	
Drawn By Dessiné Par	BoxCad: BoxCad	Date 12-Mar-14
Material Matière	14 Ga Cold Rolled A1008 CS Type B (1.7mm)	
Color Couleur	Asa-61 Grey	Finish Fini Smooth
Description		Detail Rev.
5412ESBU 48" x 36" Cover		
Part Number Numéro Pièce	Rev.	7
5412ESBU483612C	0	9

SEE BILL OF MATERIAL ON LAST PAGE

This drawing is confidential and must not be reproduced or used without the consent of EXM

Ce dessin est confidentiel et ne doit pas être reproduit ou utilisé sans le consentement de EXM

STANDARD FEATURES ARE NOT LISTED IN THIS HOLE TABLE			
HOLE TABLE - FRONT VIEW (CUSTOM FEATURE ONLY)			
CUT-OUT	XDIM	YDIM	DESCRIPTION
1	1.486	1.756	STUD M6 x 18mm (Inside)
2	1.486	46.047	STUD M6 x 18mm (Inside)
3	32.423	46.047	STUD M6 x 18mm (Inside)
4	32.423	1.756	STUD M6 x 18mm (Inside)
5	1.486	23.902	STUD M6 x 18mm (Inside)
6	32.423	23.902	STUD M6 x 18mm (Inside)
7	2.191	2.350	STUD M6 x 18mm (Inside)
8	2.191	45.713	STUD M6 x 18mm (Inside)
9	31.718	45.713	STUD M6 x 18mm (Inside)
10	31.718	2.350	STUD M6 x 18mm (Inside)
11	33.663	42.896	CLOSING BAR STUD (Inside)
12	33.663	4.907	CLOSING BAR STUD (Inside)
13	17.889	1.435	STUD M6 x 18mm (Inside)

14	3.750	44.053	LABEL_EXM (Inside)
15	33.663	23.902	885 ESL2A

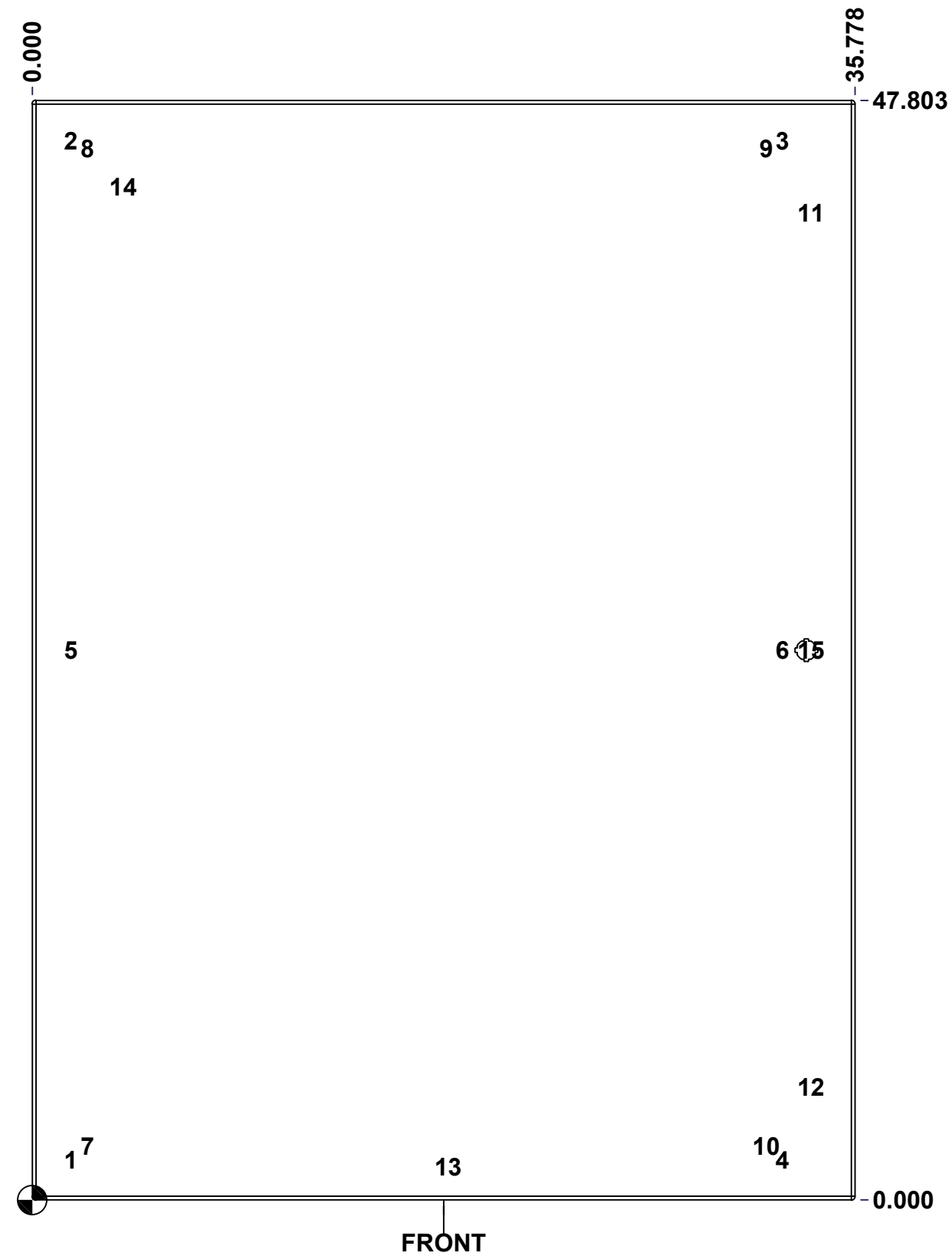

	Description	Status
	5412ESBU 48" x 36" Cover	(NULL)
	Part Number	Rev.
	Numéro Pièce 5412ESBU483612C	0 / 8 9

This drawing is confidential and must not be reproduced or used without the consent of EXM

Ce dessin est confidentiel et ne doit pas être reproduit ou utilisé sans le consentement de EXM

No.	Revisions	Date	By/Par

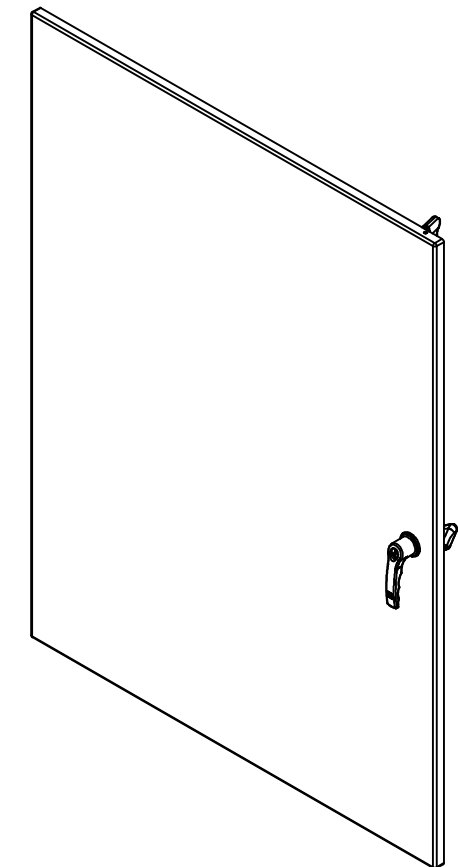

Isometric View



2	STK-Q-90042	4	5412 ES - Cabinet Closing Bar End (Small)
2	STK-Q-45655-48	0	5412 ES - Closing Bar
1	STK-Q-50536	13	5412 ES - Handle Cam Clockwise (Grip 32mm)
1	STK-Q-90051	3	5412 ES - Handle Cam Spacer
1	885 ESL2A	4	5412 ES Key Lock L-Handle (3 Pts)
1	STK-S-00100	0	3.5" x 2" Silver Milar Flexcon Sticker
1	STK-P-02400S	0	Powder Paint (Asa-61 Grey / Smooth)
1	STK-Q-46515	3	5412 ES Door Support with Brass Insert
2	STK-Q-46025-36-3	0.1. 1	5412 ES Horizontal Door Stiffener 36" (3 Pts)
2	STK-Q-46020-48	5	5412 ES Vertical Door Stiffener 48"
2	STK-Q-16405	6	Guide Stud - Small (No Paint Cap Required)
11	STK-Q-16055	1	M6 x 18mm Stud (No Paint Cap Required)
4	STK-A-33005	4	5412 ESBU Hinge 180° (Body Part)
1	5412ESBU483612G	0	5412ESBU 48" x 36" Cover Gasket Part
1	5412ESBU483612C-P	0	5412ESBU 48" x 36" Cover Part
10	STK-Q-07220	1	M6 Nylon Insert Lock Nut
QTY	Part Number	Rev	Description
Parts List			

Tél: (450) 979-4373 Fax: (450) 979-4626 www.exmweb.com	Flatness Aplatissement	Max 3.0mm
	Projection	
Customer Client	Date	
Drawn By Dessiné Par	BoxCad: BoxCad	Date 12-Mar-14
Material Matière	14 Ga Cold Rolled A1008 CS Type B (1.7mm)	
Color Couleur	Asa-61 Grey	Finish Fini Smooth
Description	Detail Rev.	
5412ESBU 48" x 36" Cover		
Part Number Numéro Pièce	Rev.	9
5412ESBU483612C	0	9

This drawing is confidential and must not be reproduced or used without the consent of EXM

Ce dessin est confidentiel et ne doit pas être reproduit ou utilisé sans le consentement de EXM

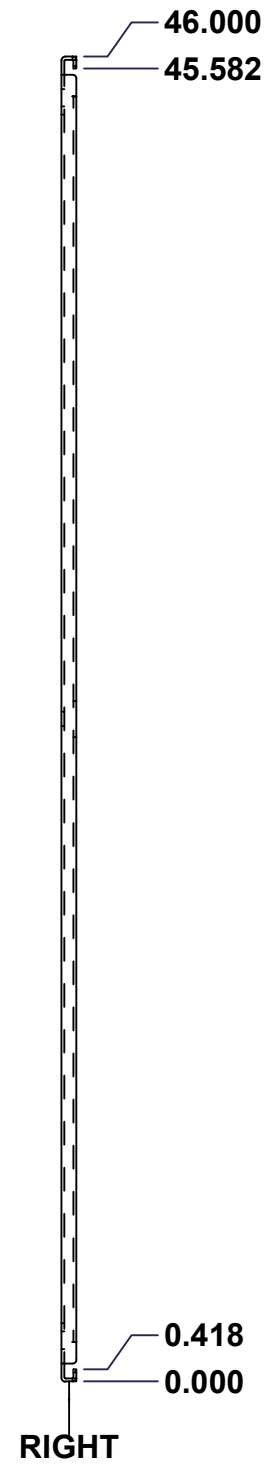
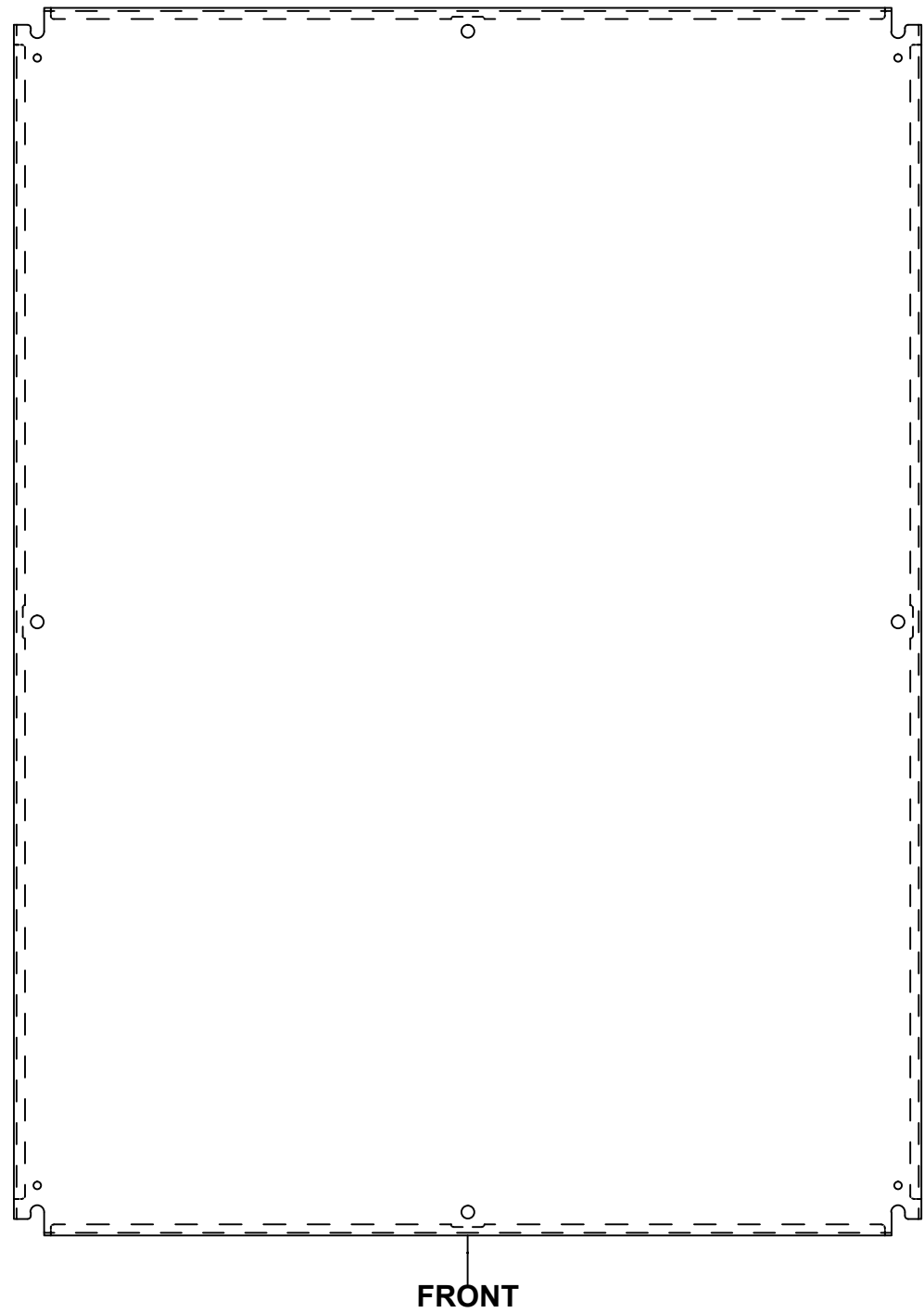
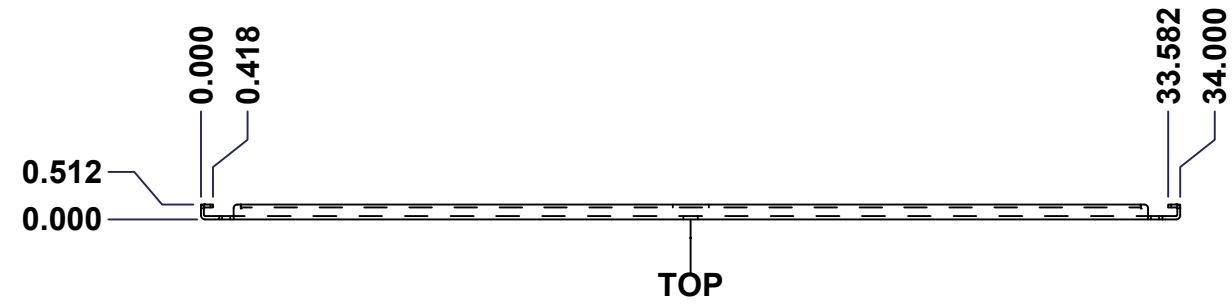

No.	Revisions	Date	By/Par

Isometric View

<p>Tél: (450) 979-4373 Fax: (450) 979-4626 www.exmweb.com</p>	Flatness Aplatissement Max 3.0mm
	Projection
Customer Client	Date
Drawn By / Dessiné Par: BoxCad	Date: 23-Jan-07
Material / Matière: See Part List	
Color / Couleur: See Part List	Finish / Fini: See Part List
Description: 881 SP - Inner Panel	
Detail Rev.	
Part Number / Numéro Pièce: 881 SP4836G	Rev. 0

Qty	Part Number	Rev	Description	Material	Color	Finish
1	881 SP4836G-P	0	881 SP - Inner Panel Part	12 Ga Galvanized	Unpainted	Galvanized

Parts List

This drawing is confidential and must not be reproduced or used without the consent of EXM

Ce dessin est confidentiel et ne doit pas être reproduit ou utilisé sans le consentement de EXM

Table 1			FRONT VIEW
CUT-OUT	XDIM	YDIM	DESCRIPTION
1	17.000	0.875	MTG STUD HOLE (RND Ø0.500)
2	0.875	23.000	MTG STUD HOLE (RND Ø0.500)
3	33.125	23.000	MTG STUD HOLE (RND Ø0.500)
4	17.000	45.125	MTG STUD HOLE (RND Ø0.500)
5	0.875	1.875	GROUND HOLE (RND Ø0.290)
6	33.125	1.875	GROUND HOLE (RND Ø0.290)
7	0.875	44.125	GROUND HOLE (RND Ø0.290)
8	33.125	44.125	GROUND HOLE (RND Ø0.290)

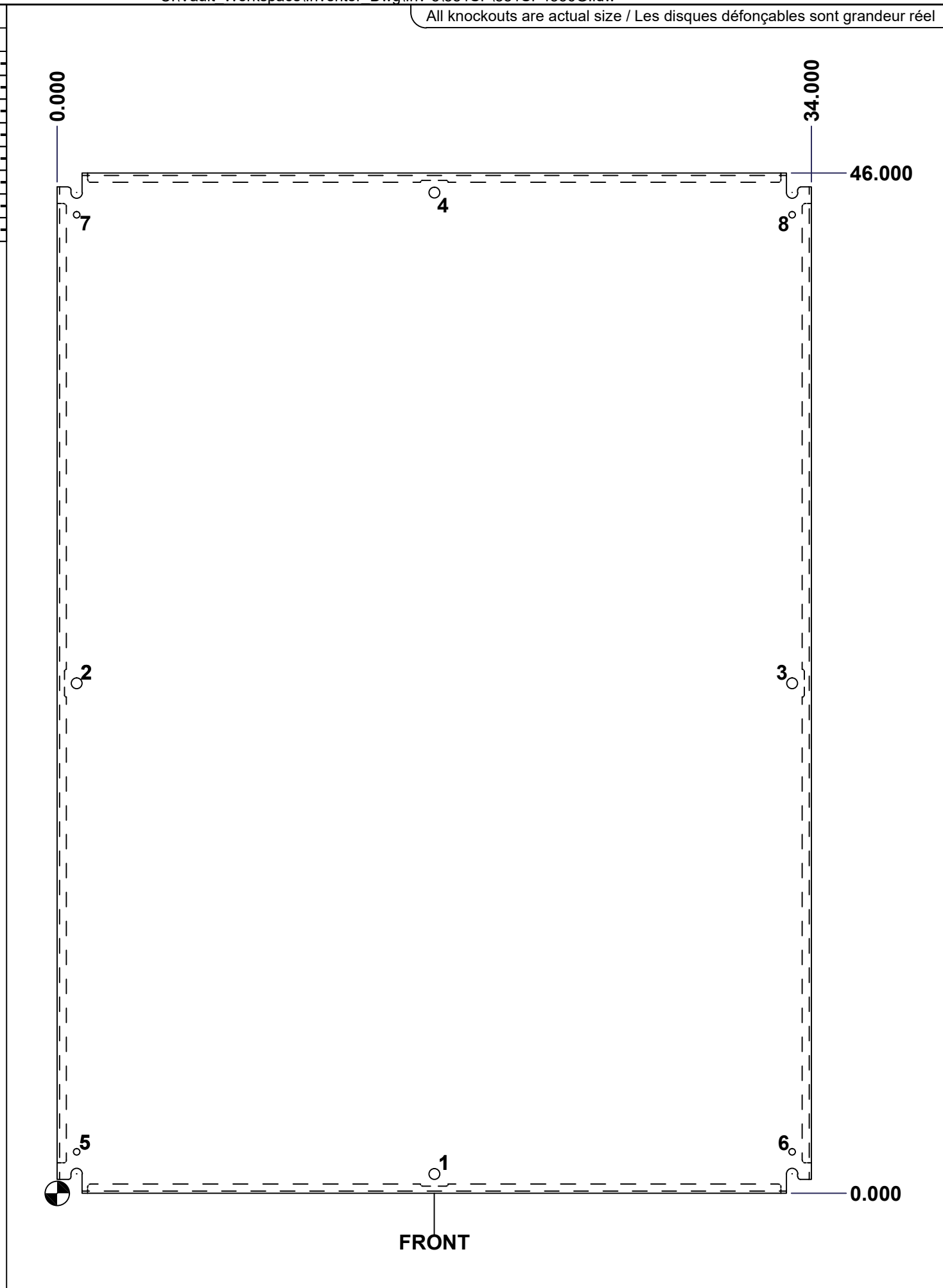

All knockouts are actual size / Les disques défonçables sont grandeur réel

No.	Revisions	Date	By/Par

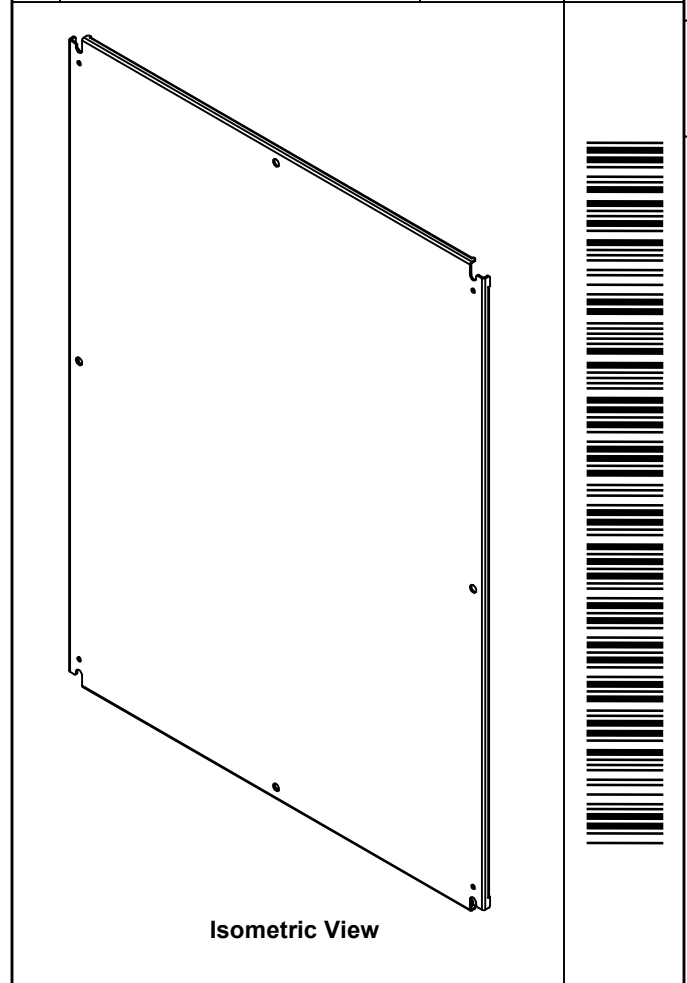

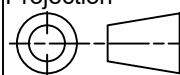
 Tél: (450) 979-4373 Fax: (450) 979-4626 www.exmweb.com	Flatness Aplatissement Max 3.0mm
	Projection 
Customer Client	Date
Drawn By Dessiné Par BoxCad	Date 23-Jan-07
Material Matière	See Part List
Color Couleur	See Part List
Finish Fini	See Part List
Description 881 SP - Inner Panel	Detail Rev.
Part Number Numéro Pièce 881 SP4836G	Rev. 0

