

This drawing is confidential and must not be reproduced or used without the consent of EXM

Ce dessin est confidentiel et ne doit pas être reproduit ou utilisé sans le consentement de EXM

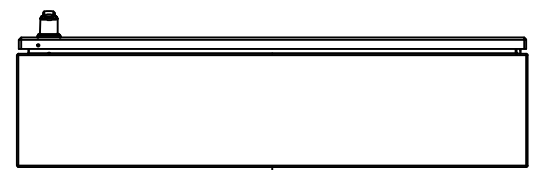

TOP

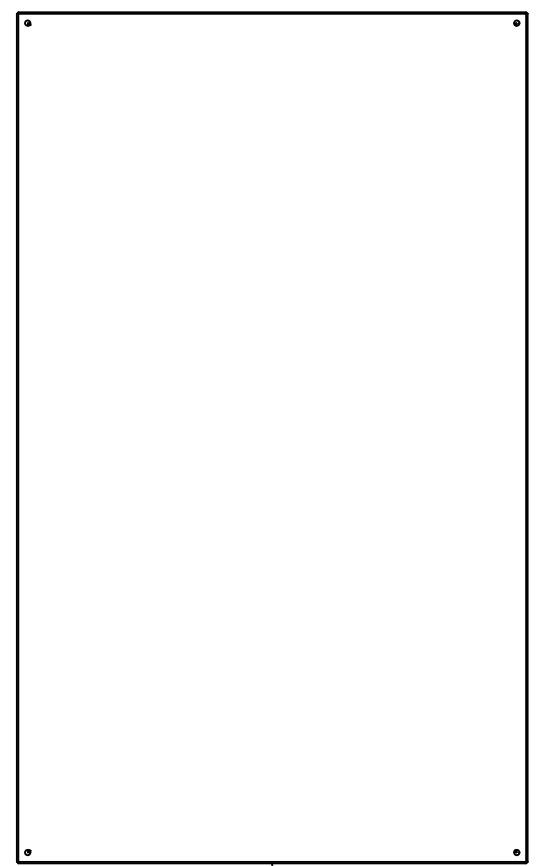

BACK



BOTTOM

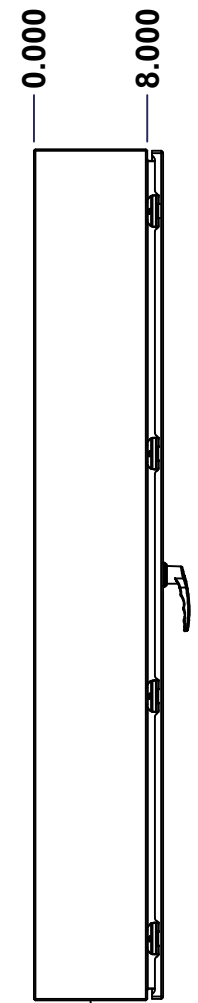

LEFT

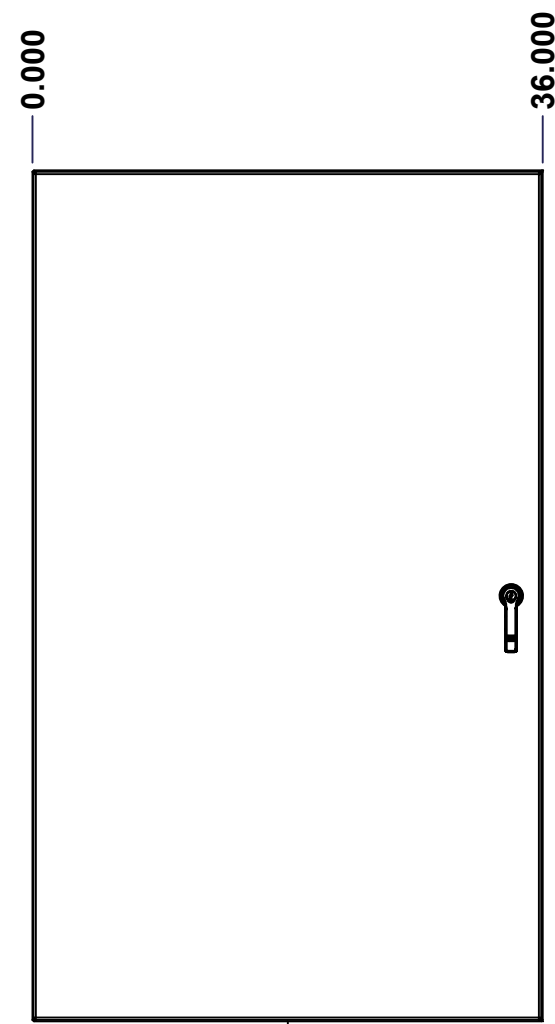

FRONT

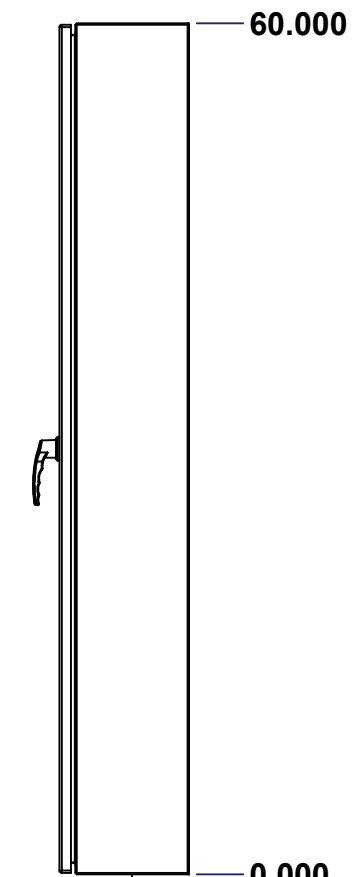

RIGHT

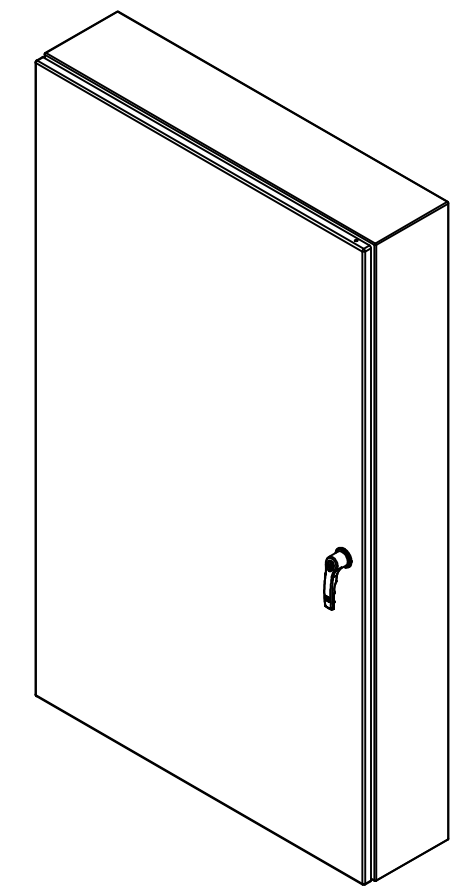

Isometric View

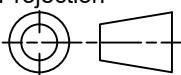

| No. | Revisions | Date | By/Par |
|-----|-----------|------|--------|
|     |           |      |        |
|     |           |      |        |
|     |           |      |        |
|     |           |      |        |

|  |   |   |
|--|---|---|
|  Tél: (450) 979-4373<br>Fax: (450) 979-4626<br><a href="http://www.exmweb.com">www.exmweb.com</a> |   | Flatness<br>Aplatissement<br>Max 3.0mm<br>Projection<br> |
| Customer Client  | Date                                      |   |
| Drawn By<br>Dessiné Par  | BoxCad: BoxCad                            | Date 05-Apr-23  |
| Material<br>Matière  | 14 Ga Cold Rolled A1008 CS Type B (1.7mm) |   |
| Color<br>Couleur   | Asa-61 Grey                               | Finish<br>Fini Smooth   |
| Description  | Detail Rev.                               |   |
| 5412ESBU 60" x 36" x 8" Assembly   |   |   |
| Part Number<br>Numéro Pièce  | Rev. 0                                    | 1<br>9  |
| <b>5412ESBU603608NOIP</b>  |   |   |

SEE BILL OF MATERIAL ON LAST PAGE

This drawing is confidential and must not be reproduced or used without the consent of EXM

Ce dessin est confidentiel et ne doit pas être reproduit ou utilisé sans le consentement de EXM

| NOTE |  |
|------|--|
| ITEM | DESCRIPTION                                |
| 1    | NEMA 4/12 Enclosure                        |
| 2    | C/W Standard ground studs on box and cover |
| 3    | C/W Standard door stiffener                |
| 4    | W/O Inner panel                            |
| 5    | C/W Standard inner panel mounting studs    |

| No. | Revisions | Date | By/Par |
|-----|-----------|------|--------|
|     |           |      |        |
|     |           |      |        |
|     |           |      |        |
|     |           |      |        |
|     |           |      |        |
|     |           |      |        |

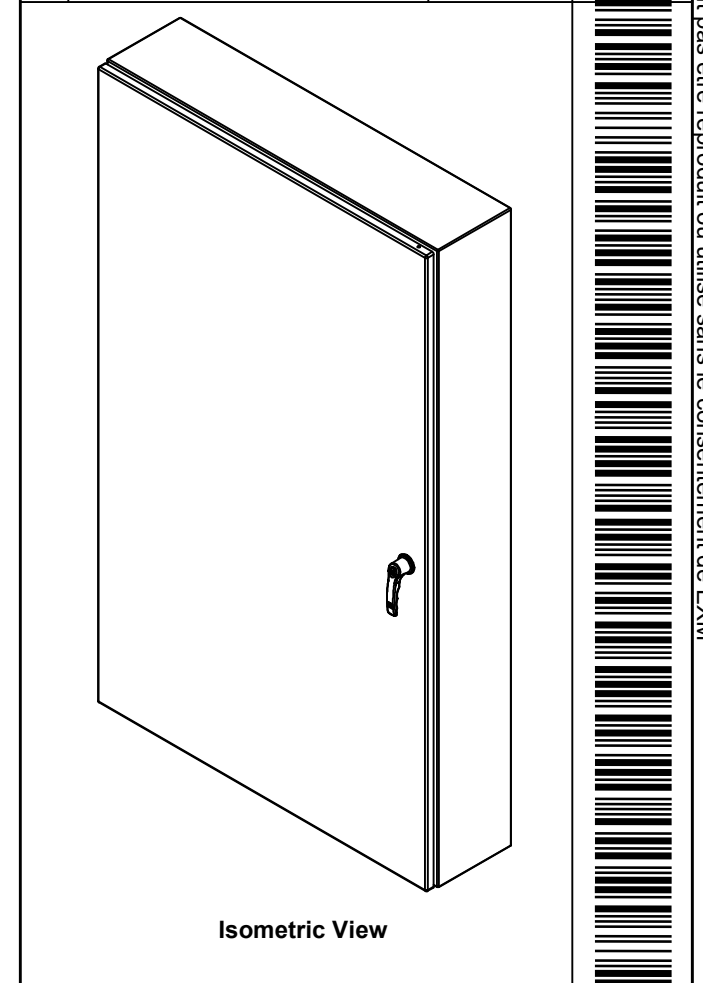

| PACKING               |     |  |
|-----------------------|-----|--|
| ITEM                  | QTY | DESCRIPTION                                    |
| Cardboard sleeve      | 2   | Top and Bottom                                 |
| Cardboard strip       | 2   | Between back of enclosure and inner panel      |
| Plastic bag           | 1   | To protect cover surface and inside gasket     |
| Cardboard corner      | 4   | To reinforced for the plastic strap tightening |
| Plastic strap - Black | 2   | To Squeeze the 2 cardboard sleeve together     |
| Packaging label       | 3   | White label with PN                            |
| Plastic strap- Green  | 2   | To secure the enclosure to the wood pallet     |
| Wood Pallet           | 1   | 2" deeper and 3" larger than enclosure size    |

|            |                     |     |  |
|------------|---------------------|-----|--|
| 1          | STK-K-01800         | 5   | 5412 ES Accessory Kit                      |
| 1          | 5412ESBU603608NOIPC | 0   | 5412ESBU 60" x 36" Cover                   |
| 1          | 5412ESBU603608NOIPB | 0   | 5412ESBU 60" x 36" x 8" Body               |
| 8          | STK-Q-04050-08      | 0   | M6 x 8mm Hexagon Socket Head Machine Screw |
| Qty        | Part Number         | Rev | Description                                |
| Parts List |                     |     |  |

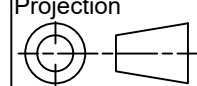
|  |   |   |
|--|---|---|
|  Tél: (450) 979-4373<br>Fax: (450) 979-4626<br><a href="http://www.exmweb.com">www.exmweb.com</a> |   | Flatness<br>Aplatissement<br>Max 3.0mm<br>Projection<br> |
| Customer Client  | Date                                      |   |
| Drawn By<br>Dessiné Par  | BoxCad: BoxCad                            | Date 05-Apr-23  |
| Material<br>Matière  | 14 Ga Cold Rolled A1008 CS Type B (1.7mm) |   |
| Color<br>Couleur   | Asa-61 Grey                               | Finish<br>Fini Smooth   |
| Description  | Detail Rev.                               |   |
| 5412ESBU 60" x 36" x 8" Assembly   |   |   |
| Part Number<br>Numéro Pièce  | Rev.                                      | 2   |
| <b>5412ESBU603608NOIP</b>  | <b>0</b>                                  | 9   |

This drawing is confidential and must not be reproduced or used without the consent of EXM

Ce dessin est confidentiel et ne doit pas être reproduit ou utilisé sans le consentement de EXM

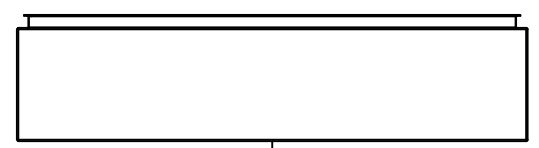

TOP

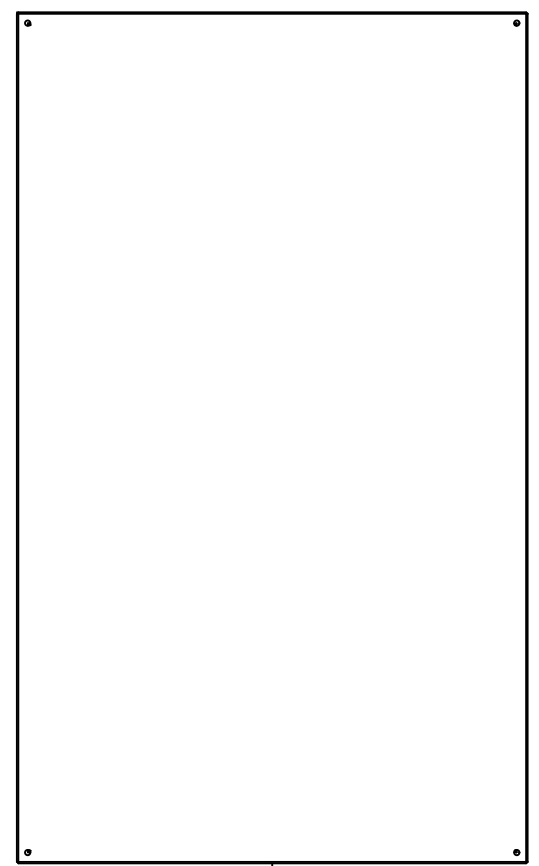

BACK



BOTTOM

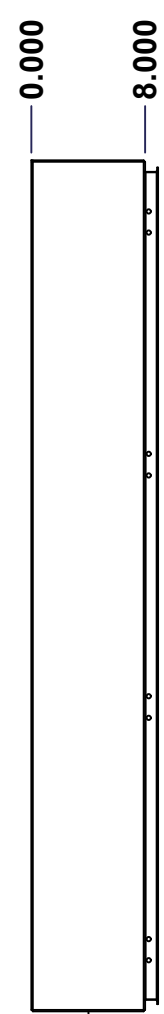

LEFT

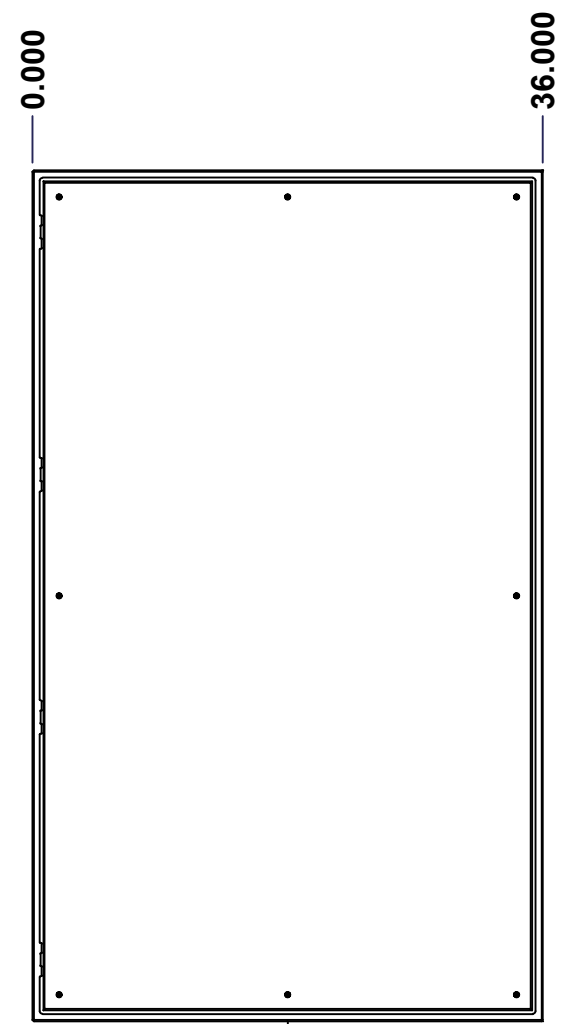

FRONT

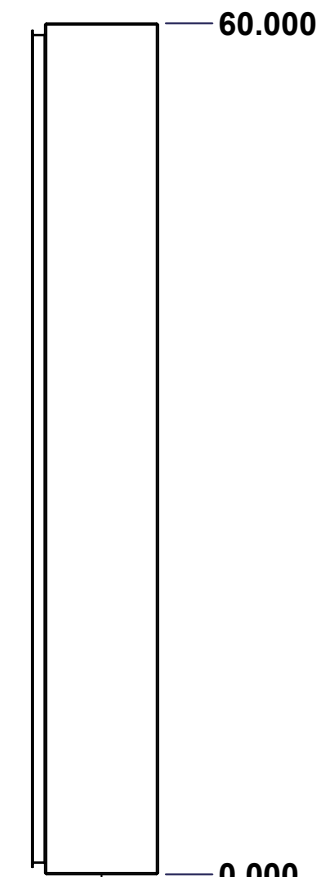

RIGHT

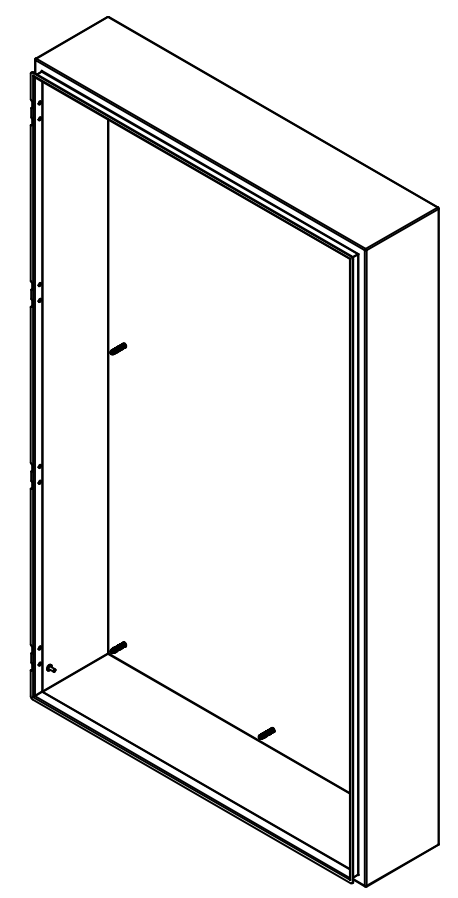

Isometric View

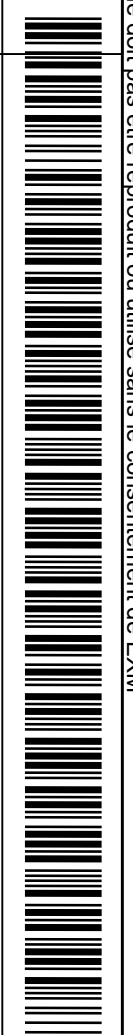

| No. | Revisions | Date | By/Par |
|-----|-----------|------|--------|
|     |           |      |        |
|     |           |      |        |
|     |           |      |        |
|     |           |      |        |

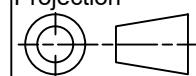
|  |   |   |
|--|---|---|
|  Tél: (450) 979-4373<br>Fax: (450) 979-4626<br><a href="http://www.exmweb.com">www.exmweb.com</a> |   | Flatness<br>Aplatissement<br>Max 3.0mm<br>Projection<br> |
| Customer<br>Client   | Date                                      |   |
| Drawn By<br>Dessiné Par  | BoxCad: BoxCad                            | Date 05-Apr-23  |
| Material<br>Matière  | 14 Ga Cold Rolled A1008 CS Type B (1.7mm) |   |
| Color<br>Couleur   | Asa-61 Grey                               | Finish<br>Fini Smooth   |
| Description  | Detail Rev.                               |   |
| 5412ESBU 60" x 36" x 8" Body   |   |   |
| Part Number<br>Numéro Pièce  | Rev. 0                                    | 3<br>9  |

SEE BILL OF MATERIAL ON LAST PAGE

**5412ESBU603608NOIPB**

This drawing is confidential and must not be reproduced or used without the consent of EXM

Ce dessin est confidentiel et ne doit pas être reproduit ou utilisé sans le consentement de EXM

| <b>STANDARD FEATURES ARE NOT LISTED IN THIS HOLE TABLE</b> |       |       |                             |
|--|-------|-------|-----------------------------|
| <b>HOLE TABLE - LEFT VIEW (CUSTOM FEATURE ONLY)</b>        |       |       |                             |
| CUT-OUT  | XDIM  | YDIM  | DESCRIPTION                 |
| 1  | 6.500 | 2.000 | GND STUD M6 x 16mm (Inside) |

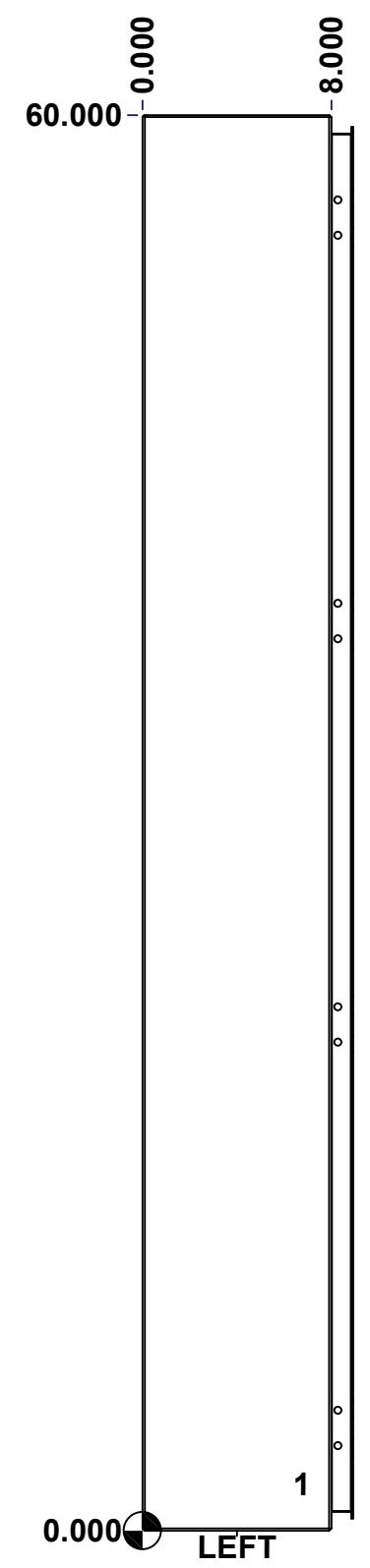

|  |                              |          |
|--|------------------------------|----------|
|  | Description                  | Status   |
|  | 5412ESBU 60" x 36" x 8" Body | (NULL)   |
|  | Part Number<br>Numéro Pièce  | Rev.     |
|  | <b>5412ESBU603608NOIPB</b>   | <b>0</b> |
|  |                              | 4        |
|  |                              | 9        |

This drawing is confidential and must not be reproduced or used without the consent of EXM

Ce dessin est confidentiel et ne doit pas être reproduit ou utilisé sans le consentement de EXM

**STANDARD FEATURES ARE NOT LISTED IN THIS HOLE TABLE**

**HOLE TABLE - BACK VIEW (CUSTOM FEATURE ONLY)**

| CUT-OUT | XDIM   | YDIM   | DESCRIPTION                |
|---------|--------|--------|----------------------------|
| 1       | 1.875  | 1.875  | IP STUD M8 x 35mm (Inside) |
| 2       | 1.875  | 58.125 | IP STUD M8 x 35mm (Inside) |
| 3       | 34.125 | 58.125 | IP STUD M8 x 35mm (Inside) |
| 4       | 34.125 | 1.875  | IP STUD M8 x 35mm (Inside) |
| 5       | 1.875  | 30.000 | IP STUD M8 x 35mm (Inside) |
| 6       | 34.125 | 30.000 | IP STUD M8 x 35mm (Inside) |
| 7       | 18.000 | 1.875  | IP STUD M8 x 35mm (Inside) |
| 8       | 18.000 | 58.125 | IP STUD M8 x 35mm (Inside) |
| -----   |        |        |                            |
| 9       | 35.250 | 0.750  | RND Ø0.390                 |
| 10      | 35.250 | 59.250 | RND Ø0.390                 |
| 11      | 0.750  | 59.250 | RND Ø0.390                 |
| 12      | 0.750  | 0.750  | RND Ø0.390                 |

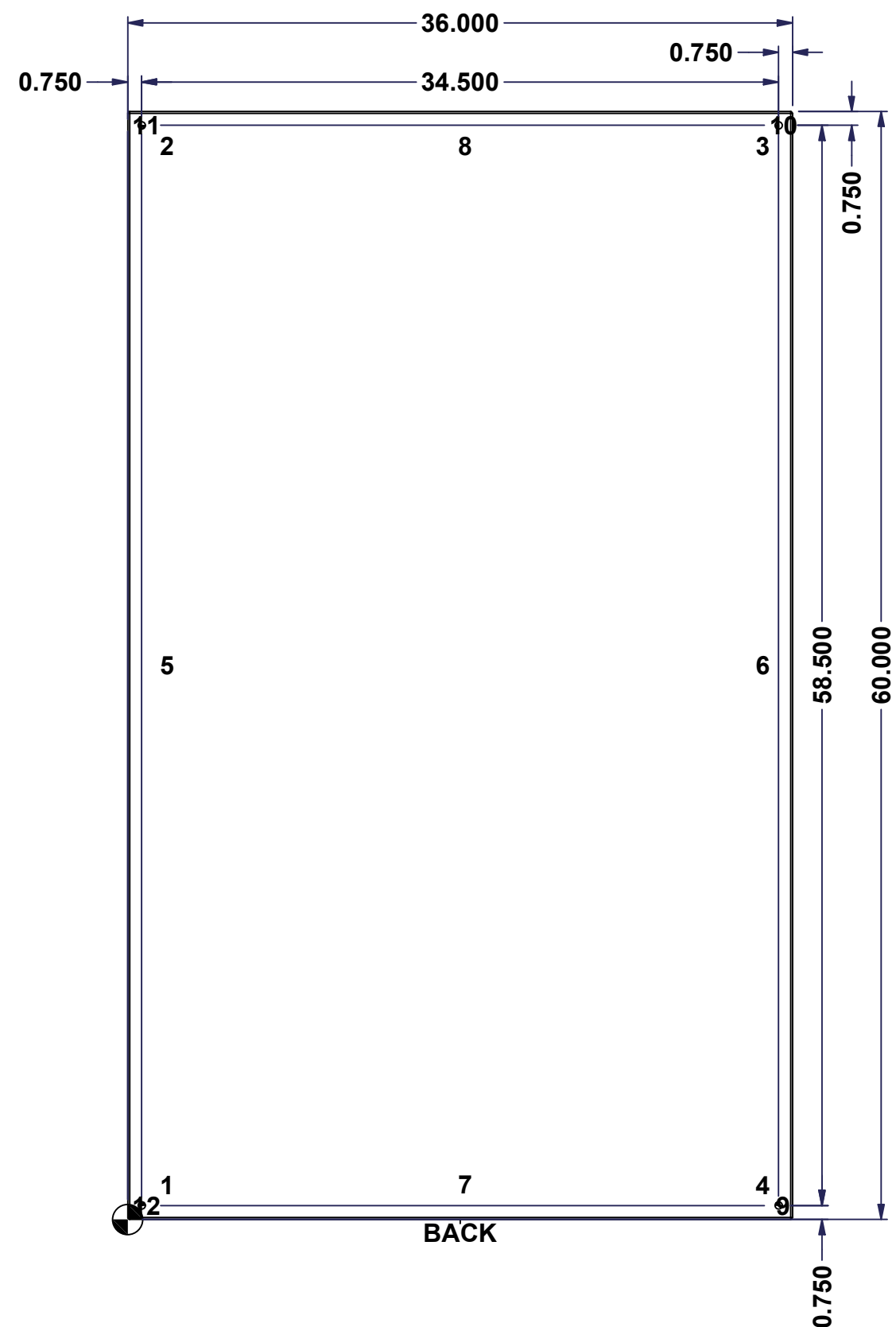

BACK

|  |                              |        |
|--|------------------------------|--------|
|  | Description                  | Status |
|  | 5412ESBU 60" x 36" x 8" Body | (NULL) |
|  | Part Number<br>Numéro Pièce  | Rev.   |
|  | 5412ESBU603608NOIPB          | 0      |
|  |                              | 5      |
|  |                              | 9      |

This drawing is confidential and must not be reproduced or used without the consent of EXM

Ce dessin est confidentiel et ne doit pas être reproduit ou utilisé sans le consentement de EXM

| No. | Revisions | Date | By/Par |
|-----|-----------|------|--------|
|     |           |      |        |
|     |           |      |        |
|     |           |      |        |
|     |           |      |        |
|     |           |      |        |

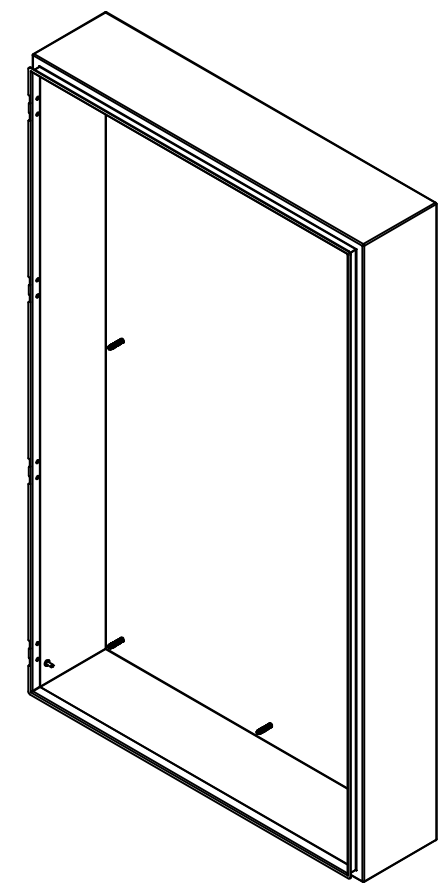

Isometric View

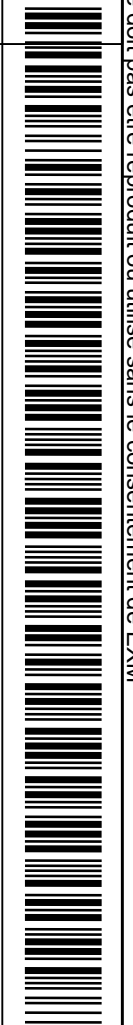

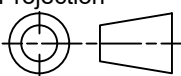
|  |   |   |
|--|---|---|
|  Tél: (450) 979-4373<br>Fax: (450) 979-4626<br><a href="http://www.exmweb.com">www.exmweb.com</a> |   | Flatness<br>Aplatissement<br>Max 3.0mm<br>Projection<br> |
| Customer Client  | Date                                      |   |
| Drawn By<br>Dessiné Par  | BoxCad: BoxCad                            | Date 05-Apr-23  |
| Material<br>Matière  | 14 Ga Cold Rolled A1008 CS Type B (1.7mm) |   |
| Color<br>Couleur   | Asa-61 Grey                               | Finish<br>Fini Smooth   |
| Description  |   | Detail Rev.   |
| 5412ESBU 60" x 36" x 8" Body   |   |   |
| Part Number<br>Numéro Pièce  | Rev.                                      | 6   |
| <b>5412ESBU603608NOIPB</b>   | <b>0</b>                                  | 9   |

| Qty        | Part Number           | Rev | Description                          |
|------------|-----------------------|-----|--------------------------------------|
| 1          | STK-Q-16080           | 0   | Ground Stud M6 x 16mm Steel          |
| 1          | STK-P-02400S          | 0   | Powder Paint (Asa-61 Grey / Smooth)  |
| 8          | STK-Q-16005           | 1   | Stud M8 x 35 (No Paint Cap Required) |
| 1          | 5412ESBU603608NOIPB-P | 0   | 5412ESBU 60" x 36" x 8" Body Part    |
| Parts List |                       |     |                                      |

This drawing is confidential and must not be reproduced or used without the consent of EXM

Ce dessin est confidentiel et ne doit pas être reproduit ou utilisé sans le consentement de EXM

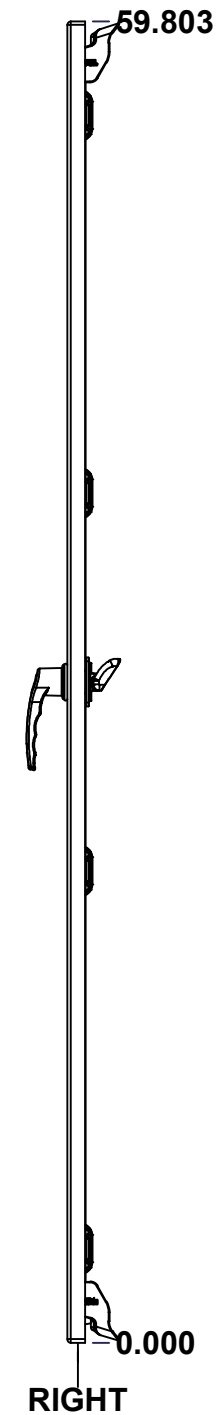
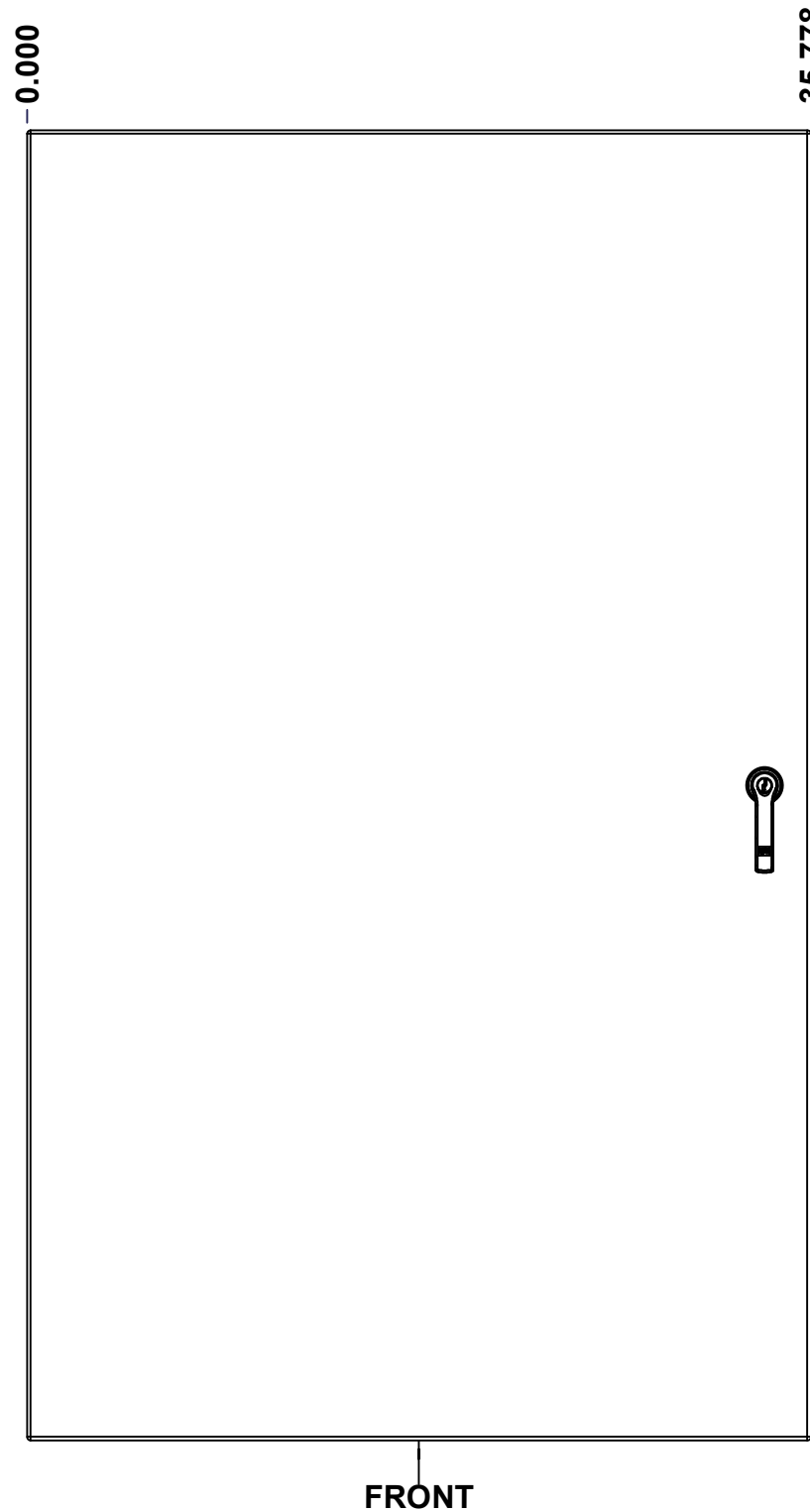
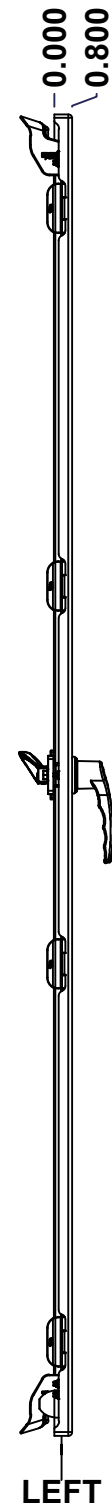
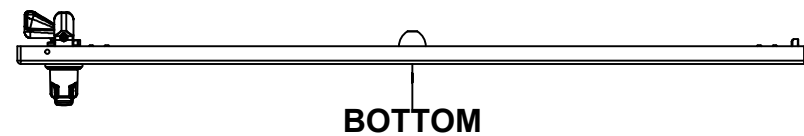
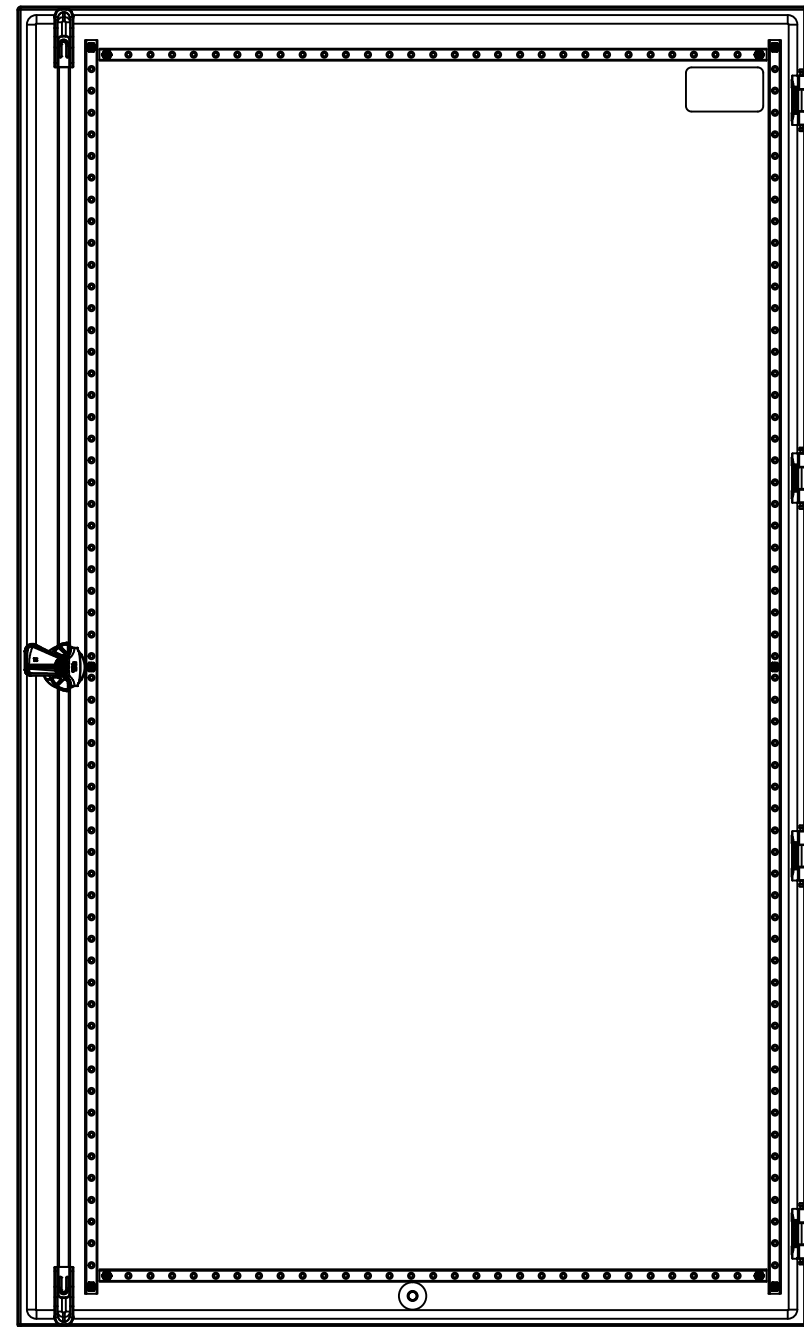
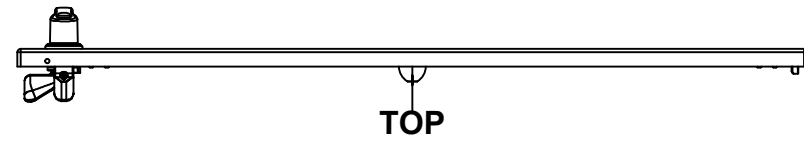

| No. | Revisions | Date | By/Par |
|-----|-----------|------|--------|
|     |           |      |        |
|     |           |      |        |
|     |           |      |        |
|     |           |      |        |
|     |           |      |        |

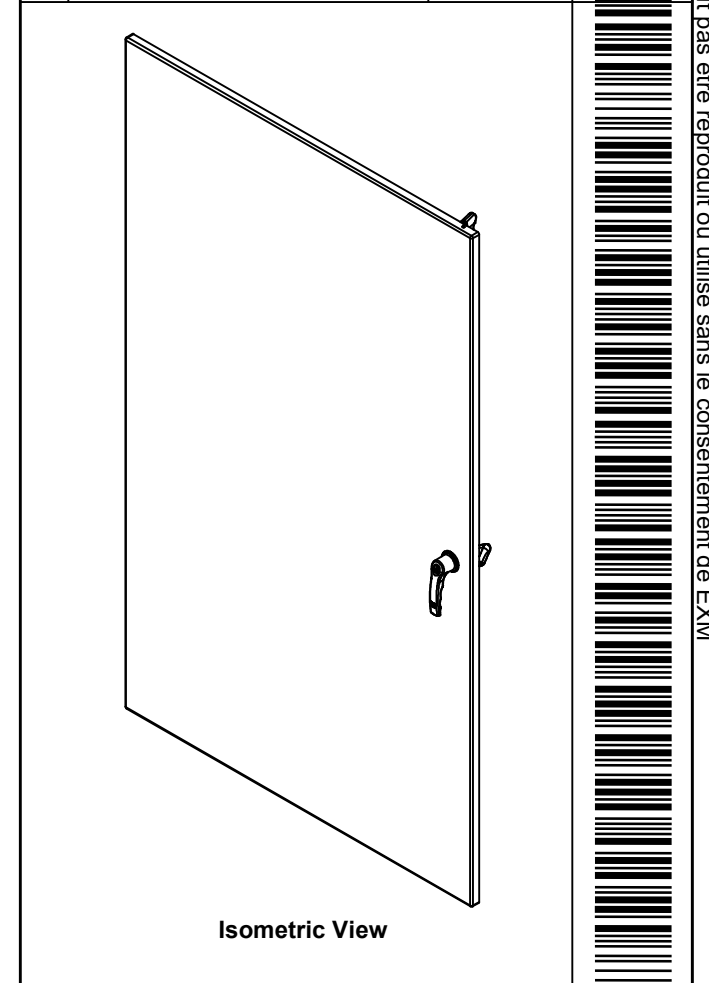

|  |   |  |
|--|---|--|
| Tél: (450) 979-4373<br>Fax: (450) 979-4626<br><a href="http://www.exmweb.com">www.exmweb.com</a> |   | Flatness<br>Aplatissement<br>Max 3.0mm<br>Projection<br> |
| Customer Client  | Date                                      |  |
| Drawn By<br>Dessiné Par  | BoxCad: BoxCad                            | Date 05-Apr-23   |
| Material<br>Matière  | 14 Ga Cold Rolled A1008 CS Type B (1.7mm) |  |
| Color<br>Couleur   | Asa-61 Grey                               | Finish<br>Fini Smooth                                    |
| Description  | Detail Rev.                               |  |
| 5412ESBU 60" x 36" Cover   |   |  |
| Part Number<br>Numéro Pièce  | Rev. 0                                    | 7<br>9   |

SEE BILL OF MATERIAL ON LAST PAGE **5412ESBU603608NOIPC**

This drawing is confidential and must not be reproduced or used without the consent of EXM

Ce dessin est confidentiel et ne doit pas être reproduit ou utilisé sans le consentement de EXM

**STANDARD FEATURES ARE NOT LISTED IN THIS HOLE TABLE**

**HOLE TABLE - FRONT VIEW (CUSTOM FEATURE ONLY)**

| CUT-OUT | XDIM   | YDIM   | DESCRIPTION               |
|---------|--------|--------|---------------------------|
| 1       | 1.486  | 1.850  | STUD M6 x 18mm (Inside)   |
| 2       | 1.486  | 57.953 | STUD M6 x 18mm (Inside)   |
| 3       | 32.423 | 57.953 | STUD M6 x 18mm (Inside)   |
| 4       | 32.423 | 1.850  | STUD M6 x 18mm (Inside)   |
| 5       | 1.486  | 29.902 | STUD M6 x 18mm (Inside)   |
| 6       | 32.423 | 29.902 | STUD M6 x 18mm (Inside)   |
| 7       | 2.191  | 2.350  | STUD M6 x 18mm (Inside)   |
| 8       | 2.191  | 57.619 | STUD M6 x 18mm (Inside)   |
| 9       | 31.718 | 57.619 | STUD M6 x 18mm (Inside)   |
| 10      | 31.718 | 2.350  | STUD M6 x 18mm (Inside)   |
| 11      | 33.663 | 54.896 | CLOSING BAR STUD (Inside) |
| 12      | 33.663 | 4.907  | CLOSING BAR STUD (Inside) |
| 13      | 17.889 | 1.435  | STUD M6 x 18mm (Inside)   |
| -----   |        |        |                           |
| 14      | 3.750  | 56.053 | LABEL_EXM (Inside)        |
| 15      | 33.663 | 29.902 | 885 ESL2A                 |

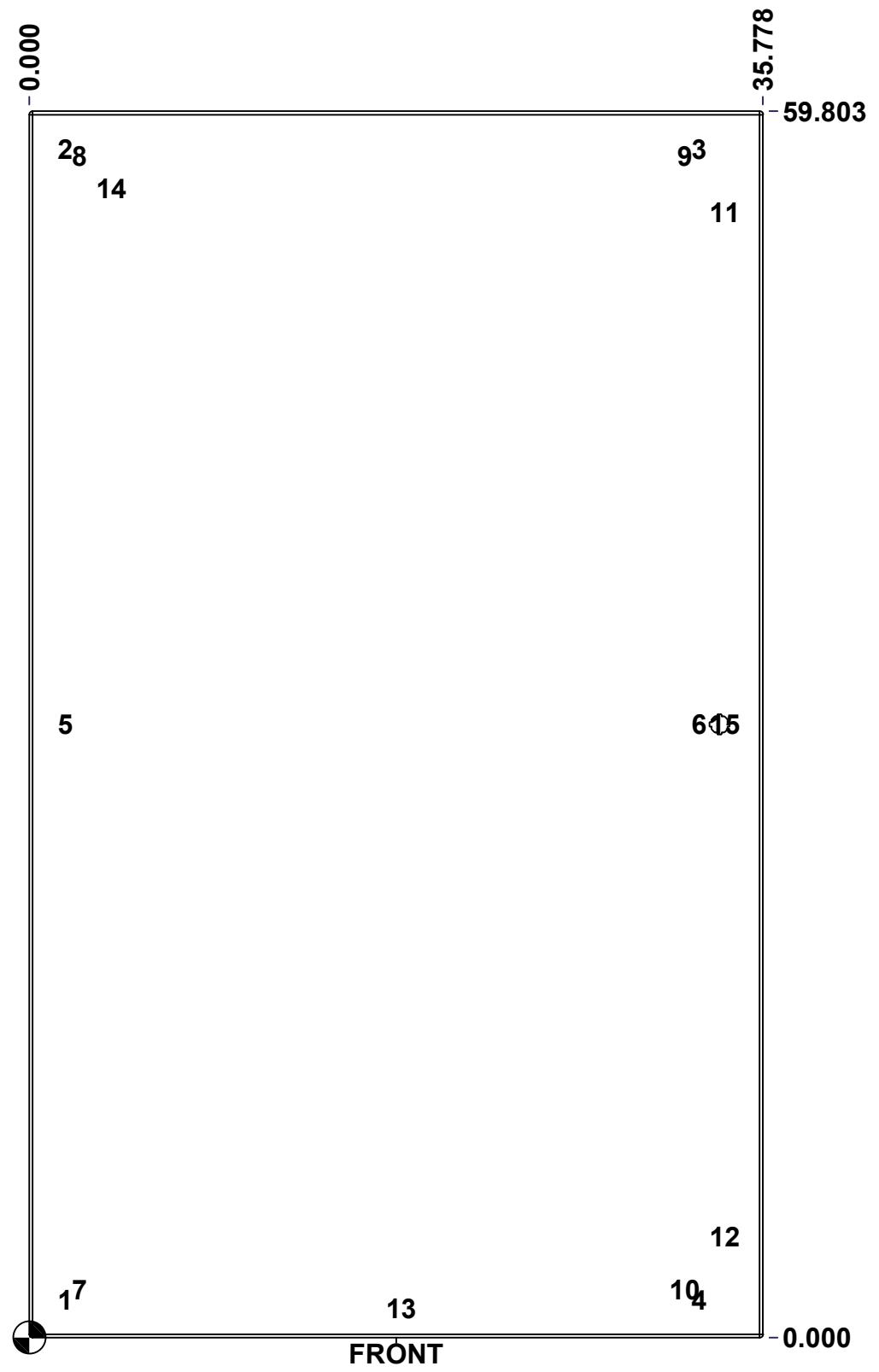

|  |                             |                  |
|--|-----------------------------|------------------|
|  | Description                 | Status           |
|  | 5412ESBU 60" x 36" Cover    | (NULL)           |
|  | Part Number<br>Numéro Pièce | Rev.             |
|  | <b>5412ESBU603608NOIPC</b>  | <b>0</b> / 8 / 9 |



This drawing is confidential and must not be reproduced or used without the consent of EXM

Ce dessin est confidentiel et ne doit pas être reproduit ou utilisé sans le consentement de EXM

| No. | Revisions | Date | By/Par |
|-----|-----------|------|--------|
|     |           |      |        |
|     |           |      |        |
|     |           |      |        |
|     |           |      |        |
|     |           |      |        |

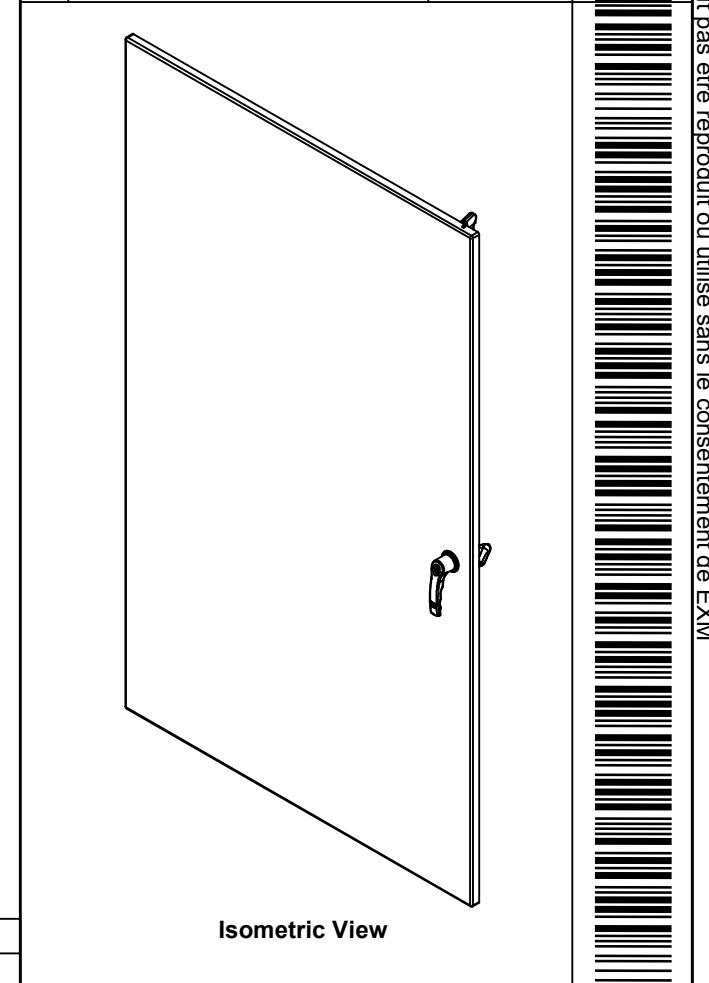

| 2          | STK-Q-90042           | 4         | 5412 ES - Cabinet Closing Bar End (Small)     |
|------------|-----------------------|-----------|---|
| 2          | STK-Q-45655-60        | 0         | 5412 ES - Closing Bar                         |
| 1          | STK-Q-50536           | 13        | 5412 ES - Handle Cam Clockwise (Grip 32mm)    |
| 1          | STK-Q-90051           | 3         | 5412 ES - Handle Cam Spacer                   |
| 1          | 885 ESL2A             | 4         | 5412 ES Key Lock L-Handle (3 Pts)             |
| 1          | STK-S-00100           | 0         | 3.5" x 2" Silver Milar Flexcon Sticker        |
| 1          | STK-P-02400S          | 0         | Powder Paint (Asa-61 Grey / Smooth)           |
| 1          | STK-Q-46515           | 3         | 5412 ES Door Support with Brass Insert        |
| 2          | STK-Q-46025-36-3      | 0.1.<br>1 | 5412 ES Horizontal Door Stiffener 36" (3 Pts) |
| 2          | STK-Q-46020-60        | 5         | 5412 ES Vertical Door Stiffener 60"           |
| 2          | STK-Q-16405           | 6         | Guide Stud - Small (No Paint Cap Required)    |
| 11         | STK-Q-16055           | 1         | M6 x 18mm Stud (No Paint Cap Required)        |
| 4          | STK-A-33005           | 4         | 5412 ESBU Hinge 180° (Body Part)              |
| 1          | 5412ESBU603608NOIPG   | 0         | 5412ESBU 60" x 36" Cover Gasket Part          |
| 1          | 5412ESBU603608NOIPC-P | 0         | 5412ESBU 60" x 36" Cover Part                 |
| 10         | STK-Q-07220           | 1         | M6 Nylon Insert Lock Nut                      |
| QTY        | Part Number           | Rev       | Description                                   |
| Parts List |                       |           |   |

|   |   |                       |
|---|---|-----------------------|
| <p>Tél: (450) 979-4373<br/>Fax: (450) 979-4626<br/><a href="http://www.exmweb.com">www.exmweb.com</a></p> | Flatness<br>Aplatissement                 | Max 3.0mm             |
|   | Projection                                |                       |
| Customer<br>Client  | Date                                      |                       |
| Drawn By<br>Dessiné Par   | BoxCad: BoxCad                            | Date 05-Apr-23        |
| Material<br>Matière   | 14 Ga Cold Rolled A1008 CS Type B (1.7mm) |                       |
| Color<br>Couleur  | Asa-61 Grey                               | Finish<br>Fini Smooth |
| Description   | Detail Rev.                               |                       |
| 5412ESBU 60" x 36" Cover  |   |                       |
| Part Number<br>Numéro Pièce   | Rev.                                      | 9                     |
| <b>5412ESBU603608NOIPC</b>  | <b>0</b>                                  | <b>9</b>              |