

This drawing is confidential and must not be reproduced or used without the consent of EXM

Ce dessin est confidentiel et ne doit pas être reproduit ou utilisé sans le consentement de EXM

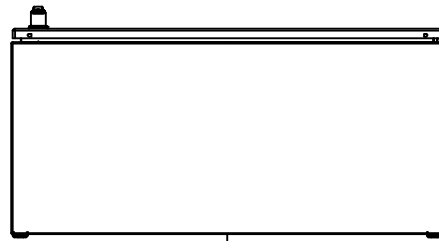

TOP

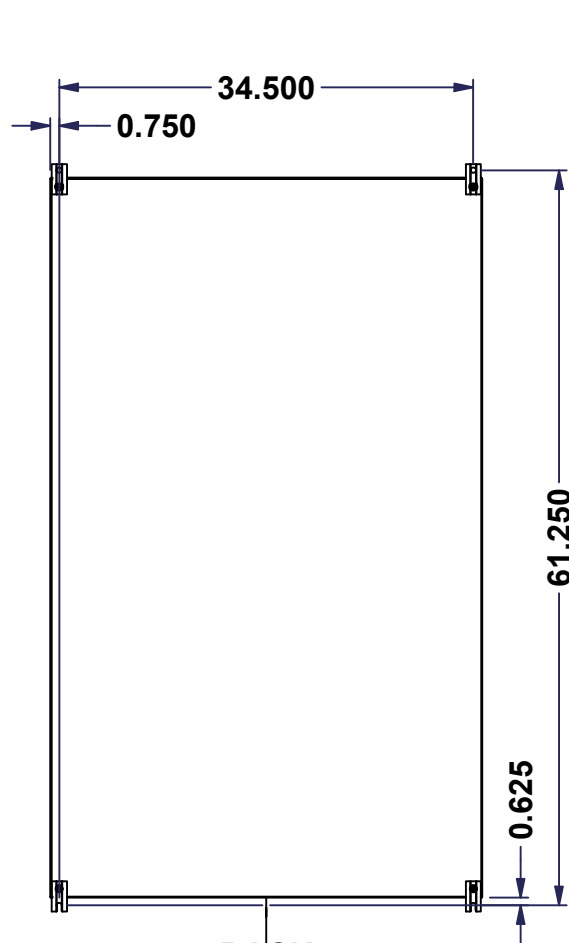

BACK

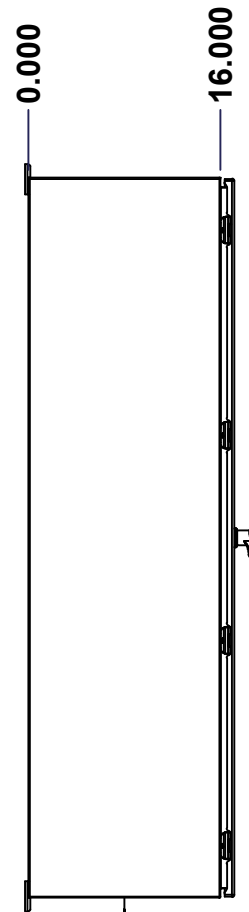

LEFT

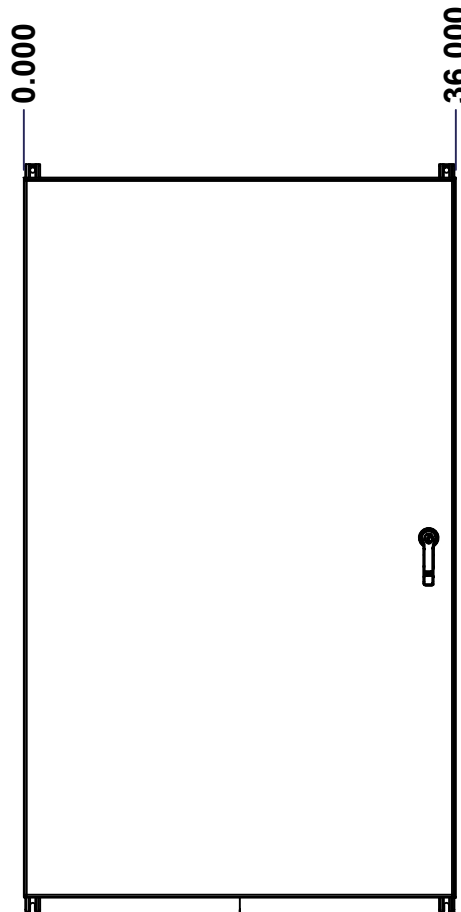

FRONT

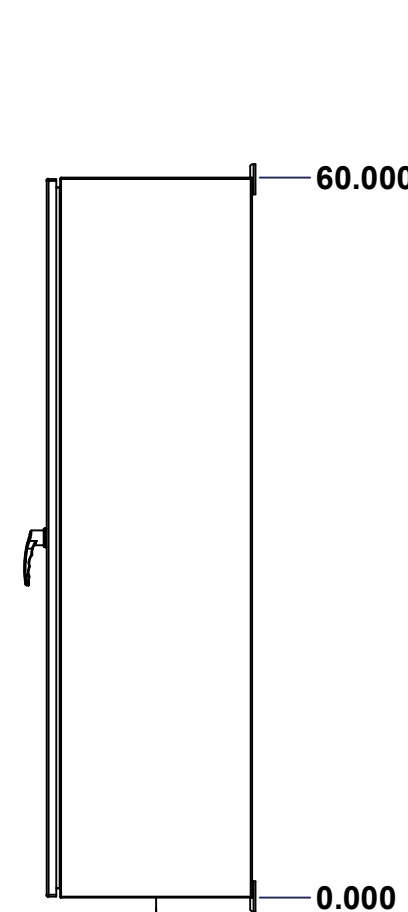

RIGHT

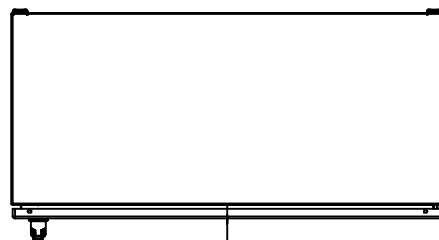

BOTTOM

No.	Revisions	Date	By/Par

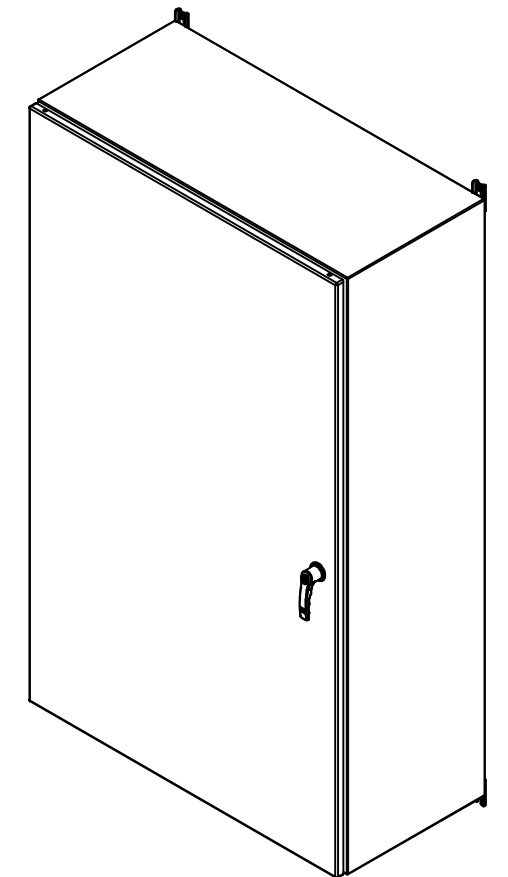

Isometric View

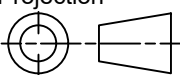

 Tél: (450) 979-4373 Fax: (450) 979-4626 www.exmweb.com		Flatness Aplatissement Max 3.0mm Projection 
Customer Client	Date	
Drawn By Dessiné Par	BoxCad: BoxCad	Date 14-Apr-23
Material Matière	14 Ga Cold Rolled A1008 CS Type B (1.7mm)	
Color Couleur	Asa-61 Grey	Finish Fini Smooth
Description	Detail Rev.	
5412ESBU 60" x 36" x 16" Assembly		
Part Number Numéro Pièce	Rev.	1
5412ESBU603616TH	0	16

SEE BILL OF MATERIAL ON LAST PAGE

This drawing is confidential and must not be reproduced or used without the consent of EXM

Ce dessin est confidentiel et ne doit pas être reproduit ou utilisé sans le consentement de EXM

NOTE	
ITEM	DESCRIPTION
1	NEMA 4/12 Enclosure
2	C/W Standard ground studs on box and cover
3	C/W Standard door stiffener
4	C/W Standard inner panel (Included)
5	C/W Standard inner panel mounting studs
6	C/W 885 ESMF3_OPEN Sold separately (Installed)
7	C/W 885 ESMF3_CLOSE Sold separately (Installed)
8	C/W R5 Insulation (Installed by EXM)

No.	Revisions	Date	By/Par

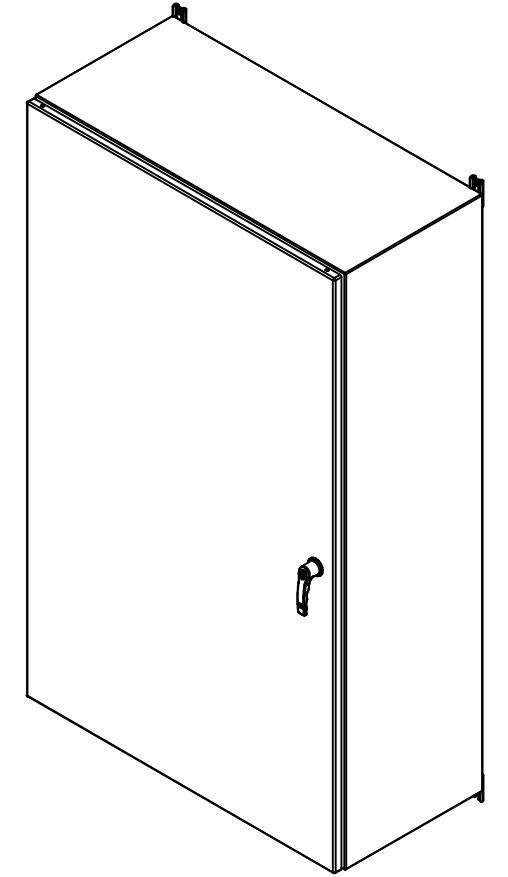

Isometric View



PACKING		
ITEM	QTY	DESCRIPTION
Cardboard sleeve	2	Top and Bottom
Cardboard strip	2	Between back of enclosure and inner panel
Plastic bag	1	To protect cover surface and inside gasket
Cardboard corner	4	To reinforced for the plastic strap tightening
Plastic strap - Black	2	To Squeeze the 2 cardboard sleeve together
Packaging label	3	White label with PN
Plastic strap- Green	2	To secure the enclosure to the wood pallet
Wood Pallet	1	2" deeper and 3" larger than enclosure size

8	STK-Q-00600	2	M12 to M8 Adaptor
1	881 SP6036G	0	881 SP - Inner Panel
1	STK-K-01800	5	5412 ES Accessory Kit
1	5412ESBU603616THC	0	5412ESBU 60" x 36" Cover
1	5412ESBU603616THB	0	5412ESBU 60" x 36" x 16" Body
8	STK-Q-04050-08	0	M6 x 8mm Hexagon Socket Head Machine Screw
Qty	Part Number	Rev	Description
Parts List			

	Tél: (450) 979-4373 Fax: (450) 979-4626 www.exmweb.com	Flatness Aplatissement Max 3.0mm Projection
	Customer Client	Date
Drawn By Dessiné Par	BoxCad: BoxCad	Date 14-Apr-23
Material Matière	14 Ga Cold Rolled A1008 CS Type B (1.7mm)	
Color Couleur	Asa-61 Grey	Finish Fini Smooth
Description 5412ESBU 60" x 36" x 16" Assembly		Detail Rev.
Part Number Numéro Pièce 5412ESBU603616TH		Rev. 0 2 16

This drawing is confidential and must not be reproduced or used without the consent of EXM

Ce dessin est confidentiel et ne doit pas être reproduit ou utilisé sans le consentement de EXM

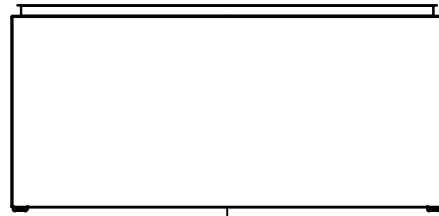

TOP

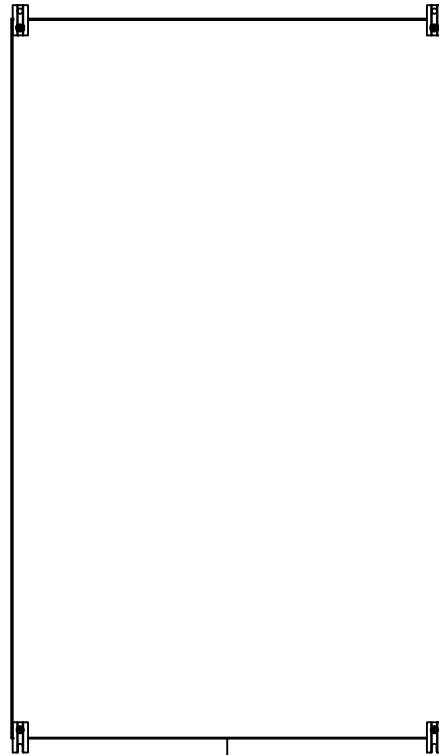

BACK

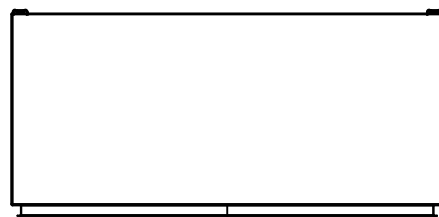

BOTTOM

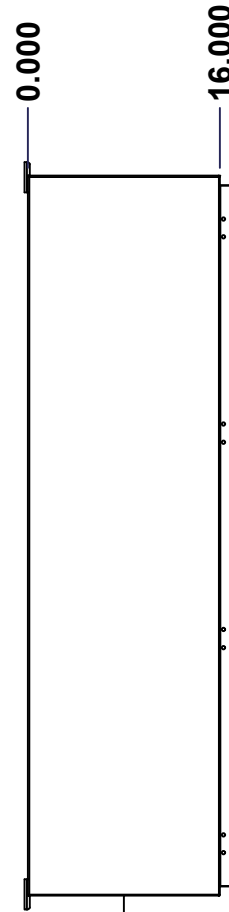

LEFT

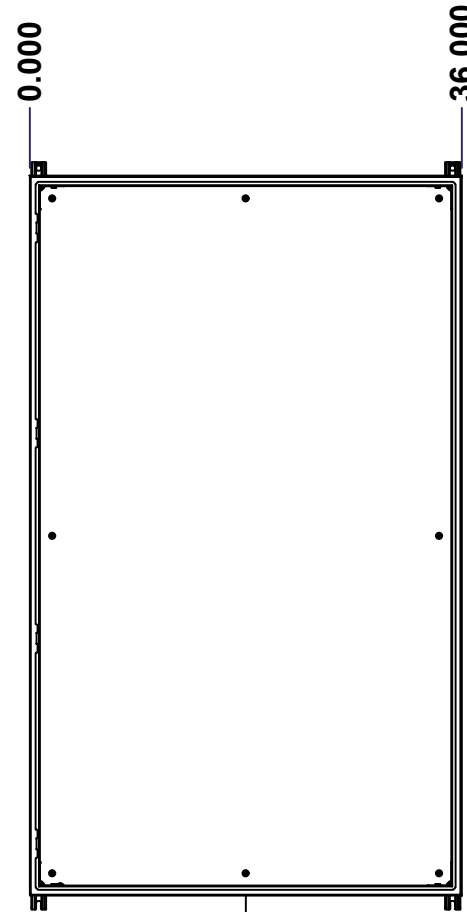

FRONT

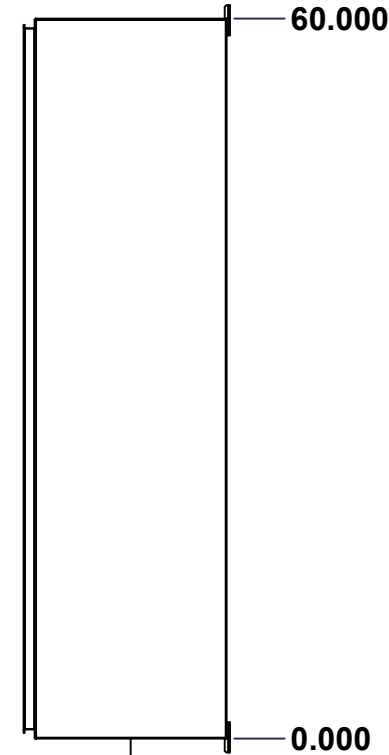

RIGHT

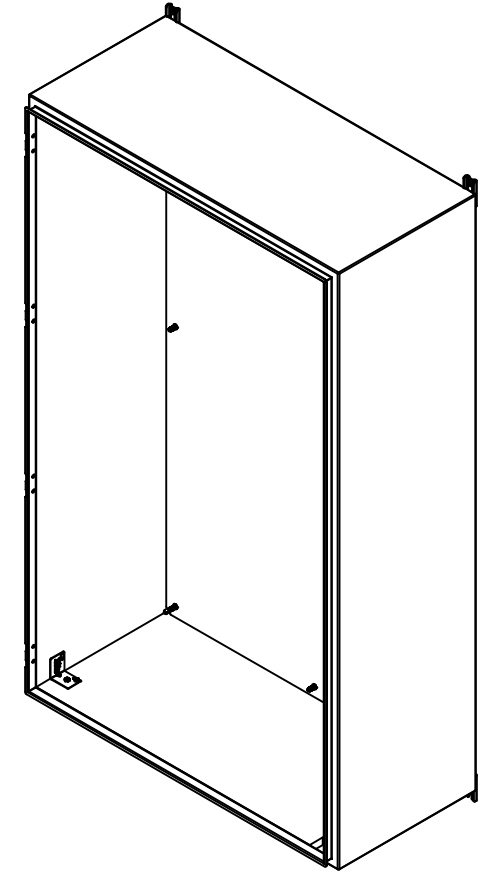

Isometric View

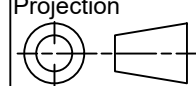

No.	Revisions	Date	By/Par

 Tél: (450) 979-4373 Fax: (450) 979-4626 www.exmweb.com		Flatness Aplatissement Max 3.0mm Projection 
Customer Client	Date	
Drawn By Dessiné Par	BoxCad: BoxCad	Date 14-Apr-23
Material Matière	14 Ga Cold Rolled A1008 CS Type B (1.7mm)	
Color Couleur	Asa-61 Grey	Finish Fini Smooth
Description	Detail Rev.	
5412ESBU 60" x 36" x 16" Body		
Part Number Numéro Pièce	Rev.	3
SEE BILL OF MATERIAL ON LAST PAGE	5412ESBU603616THB	0

SEE BILL OF MATERIAL ON LAST PAGE

5412ESBU603616THB

Rev. 3
0

This drawing is confidential and must not be reproduced or used without the consent of EXM

Ce dessin est confidentiel et ne doit pas être reproduit ou utilisé sans le consentement de EXM

STANDARD FEATURES ARE NOT LISTED IN THIS HOLE TABLE			
HOLE TABLE - TOP VIEW (CUSTOM FEATURE ONLY)			
CUT-OUT	XDIM	YDIM	DESCRIPTION
1	2.000	13.500	INSUL. STUD M6 x 18mm (Inside)
2	34.000	13.500	INSUL. STUD M6 x 18mm (Inside)

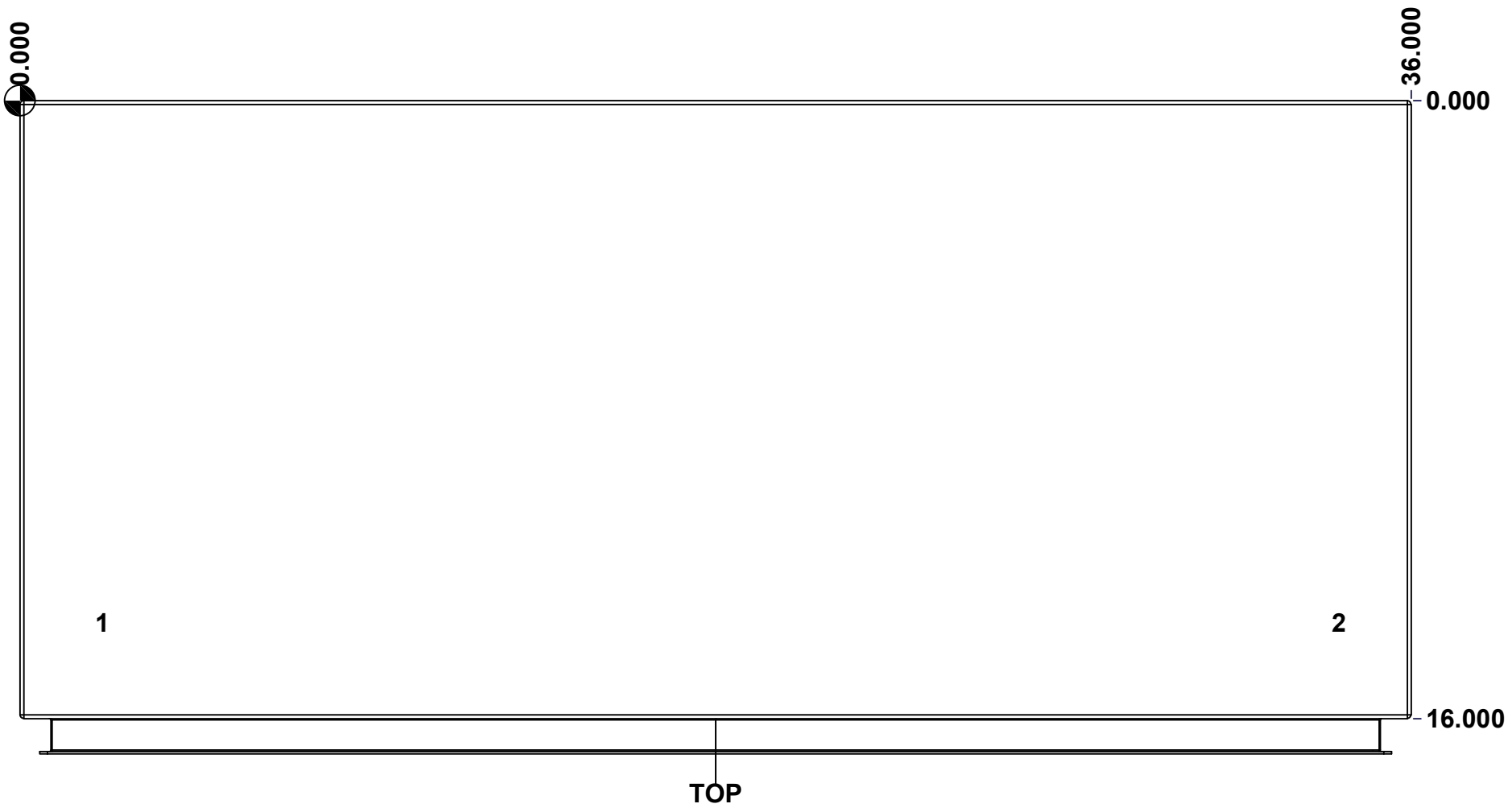

	Description	Status	
	5412ESBU 60" x 36" x 16" Body	(NULL)	
	Part Number Numéro Pièce	Rev.	
	5412ESBU603616THB	0	4 / 16

This drawing is confidential and must not be reproduced or used without the consent of EXM

Ce dessin est confidentiel et ne doit pas être reproduit ou utilisé sans le consentement de EXM

STANDARD FEATURES ARE NOT LISTED IN THIS HOLE TABLE			
HOLE TABLE - BOTTOM VIEW (CUSTOM FEATURE ONLY)			
CUT-OUT	XDIM	YDIM	DESCRIPTION
1	2.000	13.500	INSUL. STUD M6 x 18mm (Inside)
2	34.000	13.500	INSUL. STUD M6 x 18mm (Inside)

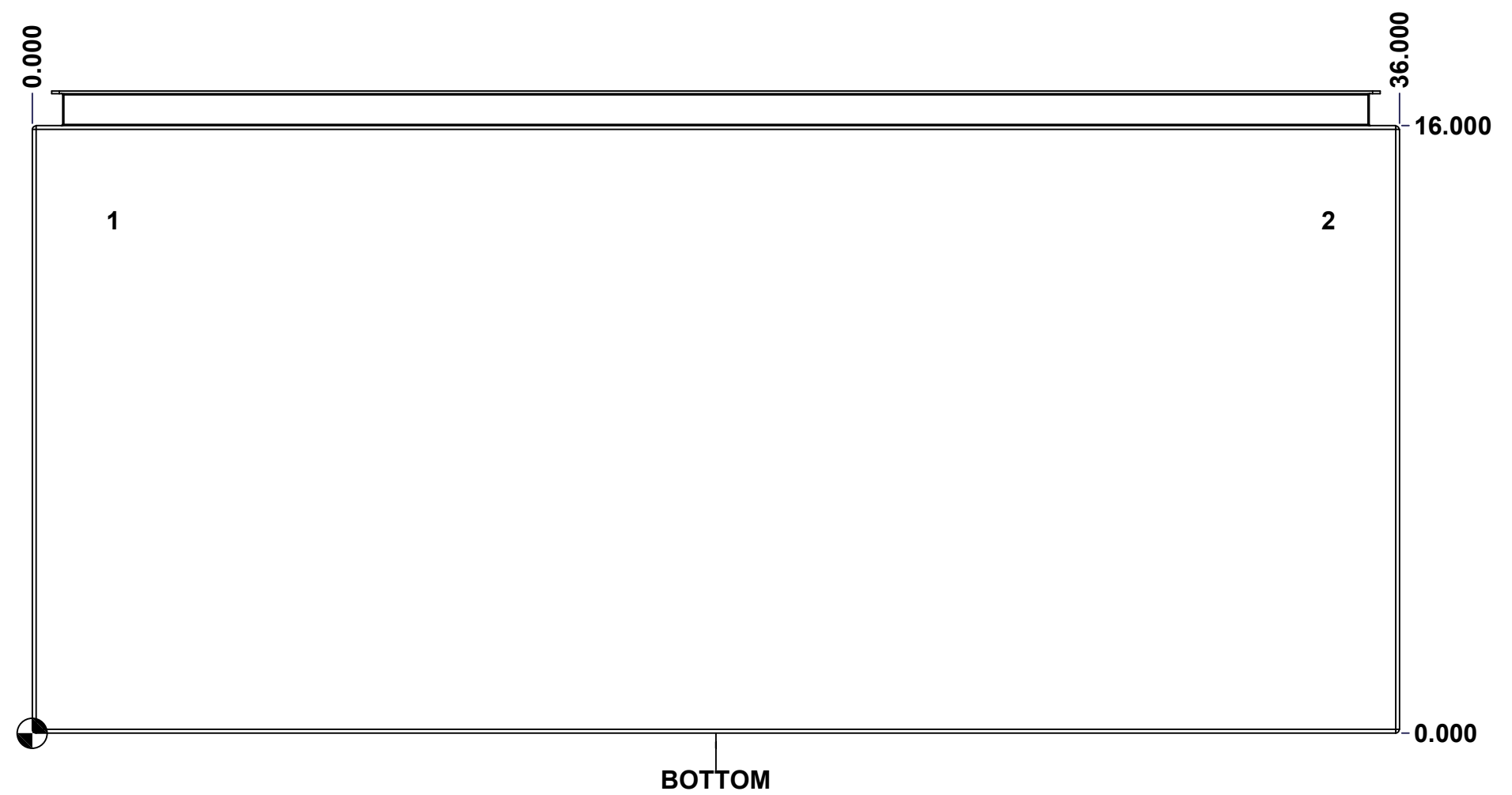

	Description		Status
	5412ESBU 60" x 36" x 16" Body		(NULL)
Part Number Numéro Pièce		Rev.	5
5412ESBU603616THB		0	16

This drawing is confidential and must not be reproduced or used without the consent of EXM

Ce dessin est confidentiel et ne doit pas être reproduit ou utilisé sans le consentement de EXM

STANDARD FEATURES ARE NOT LISTED IN THIS HOLE TABLE

HOLE TABLE - BACK VIEW (CUSTOM FEATURE ONLY)

CUT-OUT	XDIM	YDIM	DESCRIPTION
1	1.875	1.875	IP STUD M8 x 35mm (Inside)
2	1.875	58.125	IP STUD M8 x 35mm (Inside)
3	34.125	58.125	IP STUD M8 x 35mm (Inside)
4	34.125	1.875	IP STUD M8 x 35mm (Inside)
5	1.875	30.000	IP STUD M8 x 35mm (Inside)
6	34.125	30.000	IP STUD M8 x 35mm (Inside)
7	18.000	1.875	IP STUD M8 x 35mm (Inside)
8	18.000	58.125	IP STUD M8 x 35mm (Inside)

9	0.750	0.000	FOOT 885 ESMF3_OPEN
10	35.250	0.000	FOOT 885 ESMF3_OPEN
11	35.250	60.000	FOOT 885 ESMF3_CLOSE
12	0.750	60.000	FOOT 885 ESMF3_CLOSE

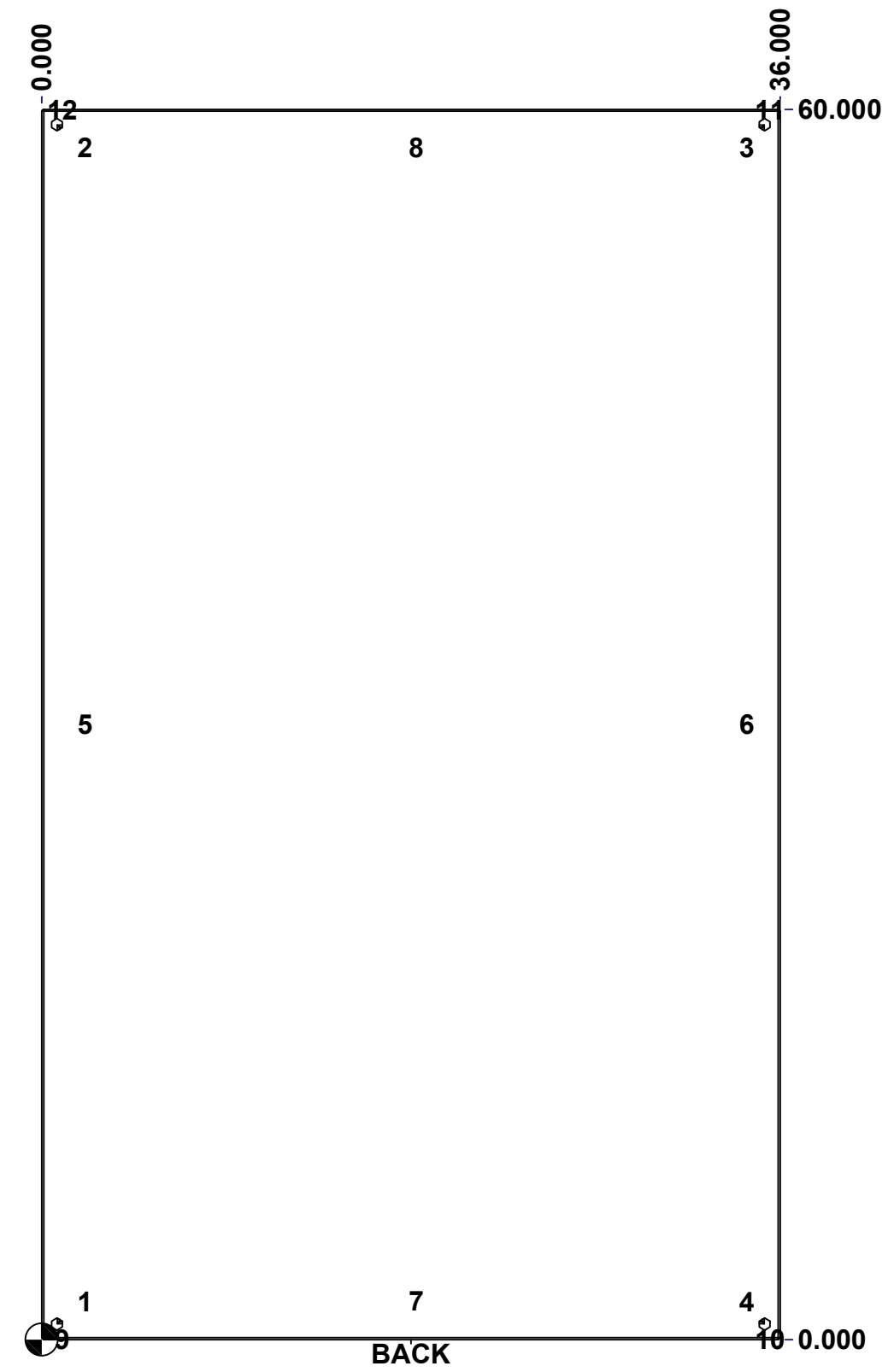

	Description	Status
	5412ESBU 60" x 36" x 16" Body	(NULL)
Part Number Numéro Pièce 5412ESBU603616THB	Rev.	6
	0	16

This drawing is confidential and must not be reproduced or used without the consent of EXM

Ce dessin est confidentiel et ne doit pas être reproduit ou utilisé sans le consentement de EXM

No.	Revisions	Date	By/Par

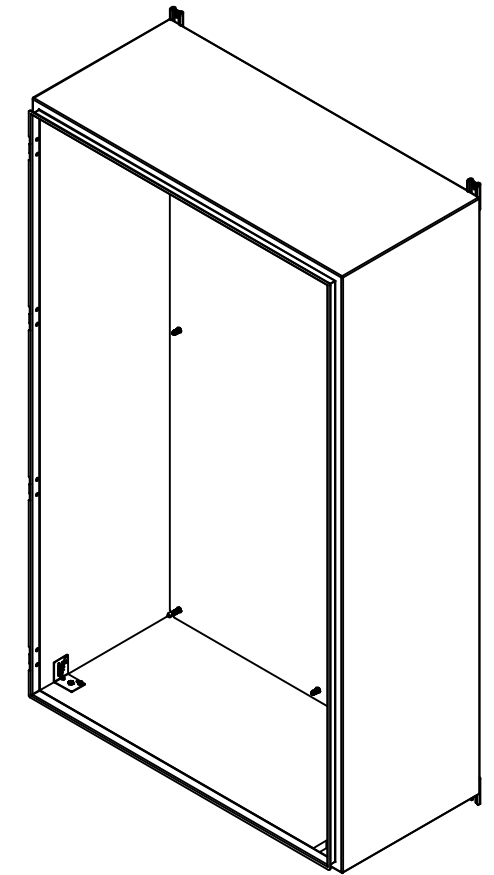

Isometric View



2	885ESMF3-FEET	0	885 ESMF3 Mounting Foot
4	RIVET_NUT_M10_FH_CE	0	Rivet Nut M10 (Low Profile Close End)
4	STK-Q-06660	2	M10 x 16mm Machine Screw
2	885ESMF3-FEET-A	0	885 ESMF3 Mounting Foot (Opened Slot)
1	STK-K-70554	3	5412 ESTH Accessory Kit
1	5412ESBU603616THI-RS	0	5412ESBU 60" x 36" Right Insulation
1	5412ESBU603616THI-LS	0	5412ESBU 60" x 36" Left Insulation
1	5412ESBU603616THI-BT	0	5412ESBU 60" x 36" Top and Bottom Insulation
1	5412ESBU603616THI-TP	0	5412ESBU 60" x 36" Top and Bottom Insulation
1	5412ESBU603616THI-B	0	5412ESBU 60" x 36" Back Insulation
4	STK-Q-16055	1	M6 x 18mm Stud (No Paint Cap Required)
1	STK-P-02400S	0	Powder Paint (Asa-61 Grey / Smooth)
8	STK-Q-16005	1	Stud M8 x 35 (No Paint Cap Required)
1	5412ESBU603616THB-P	0	5412ESBU 60" x 36" x 16" Body Part

Qty	Part Number	Rev	Description
Parts List			

	Tél: (450) 979-4373 Fax: (450) 979-4626 www.exmweb.com	Flatness Aplatissement Max 3.0mm
	Projection 	Customer Client
Drawn By Dessiné Par BoxCad: BoxCad	Date 14-Apr-23	Material Matière 14 Ga Cold Rolled A1008 CS Type B (1.7mm)
Color Couleur Asa-61 Grey	Finish Fini Smooth	Description 5412ESBU 60" x 36" x 16" Body
Part Number Numéro Pièce 5412ESBU603616THB	Rev. 0	Detail Rev. 7 / 16

This drawing is confidential and must not be reproduced or used without the consent of EXM

Ce dessin est confidentiel et ne doit pas être reproduit ou utilisé sans le consentement de EXM

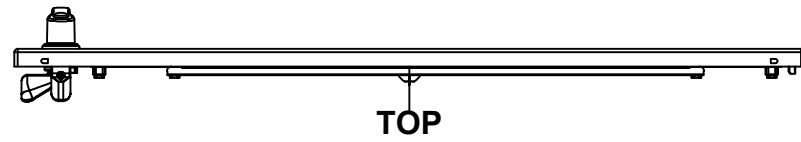

TOP

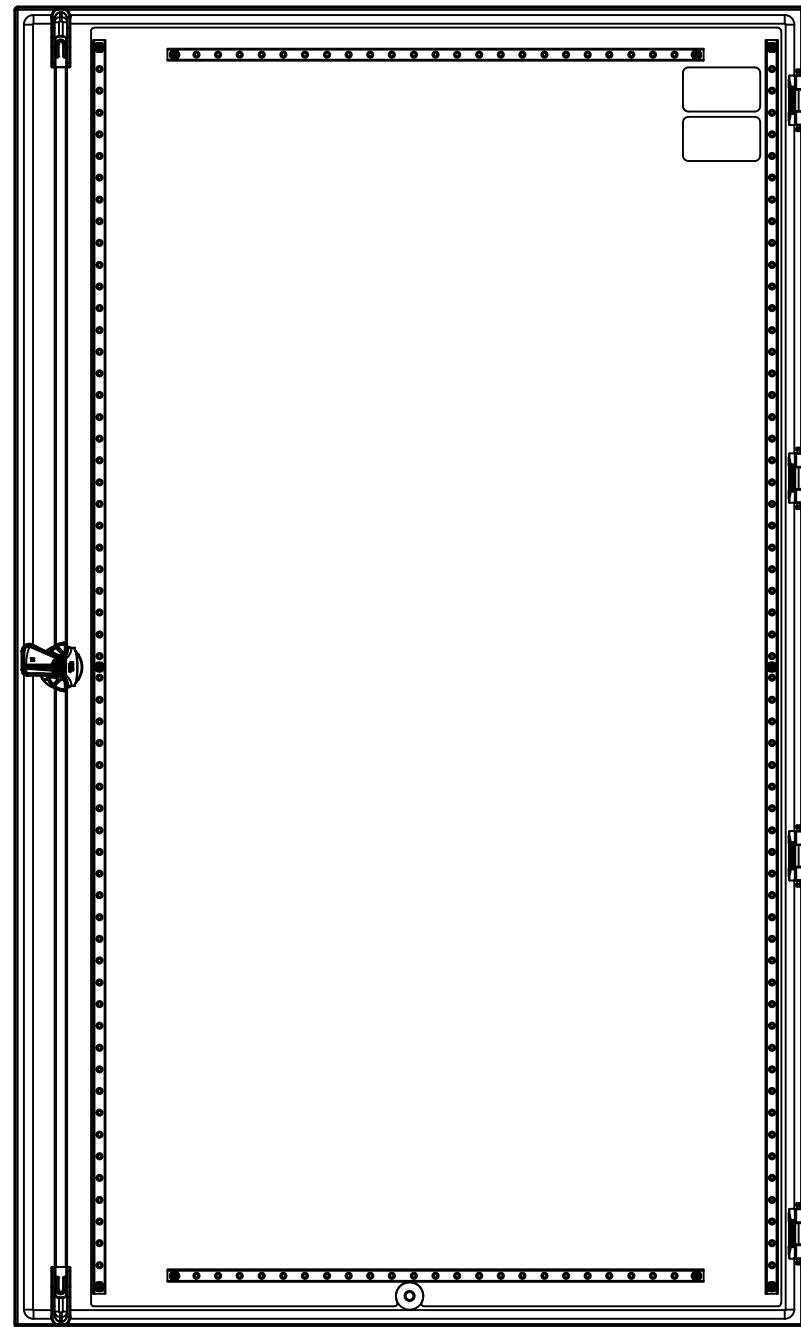

BACK

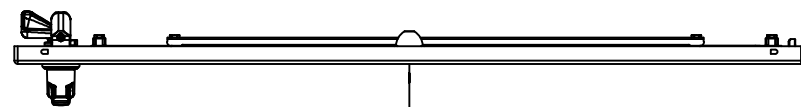

BOTTOM

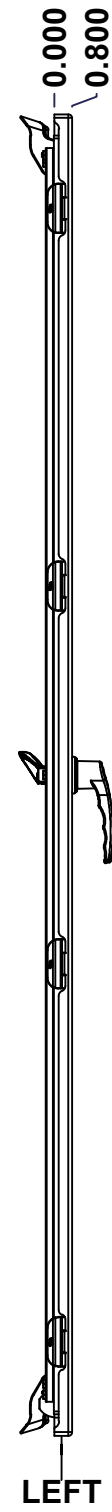

LEFT

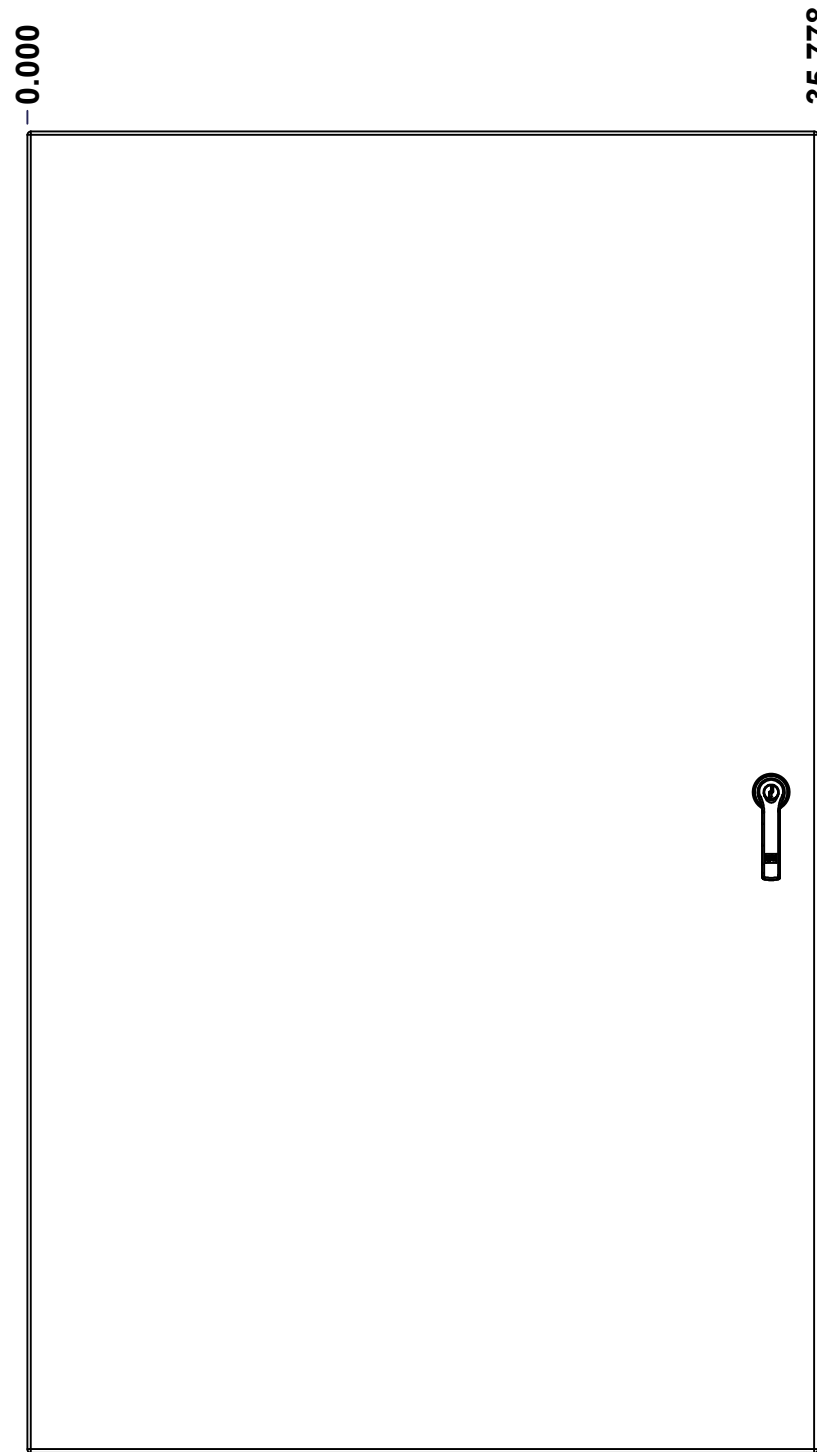

FRONT

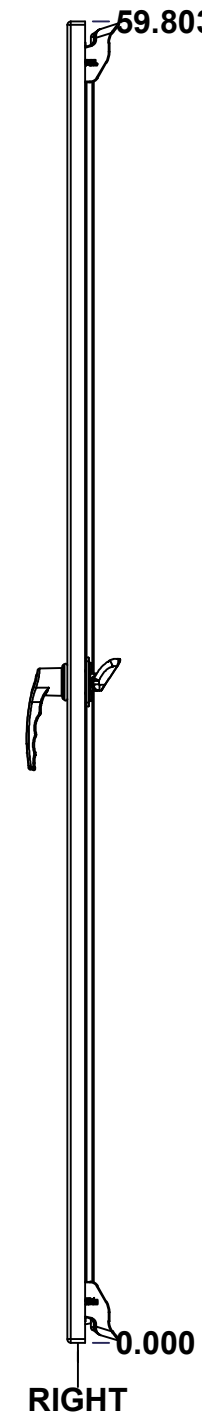

RIGHT

0.000
0.800
0.000
35.778
59.803
0.000

No.	Revisions	Date	By/Par

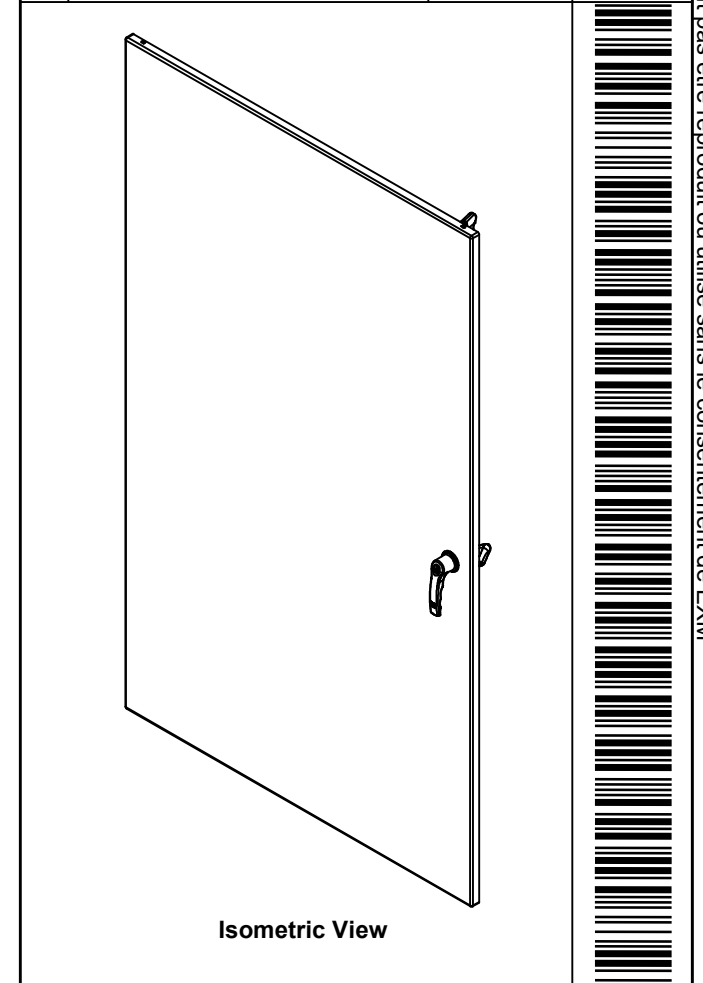

Isometric View

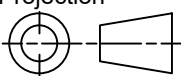

 Tél: (450) 979-4373 Fax: (450) 979-4626 www.exmweb.com		Flatness Aplatissement Max 3.0mm Projection 
Customer Client	Date	
Drawn By Dessiné Par	BoxCad: BoxCad	Date 14-Apr-23
Material Matière	14 Ga Cold Rolled A1008 CS Type B (1.7mm)	
Color Couleur	Asa-61 Grey	Finish Fini Smooth
Description		Detail Rev.
5412ESBU 60" x 36" Cover		
Part Number Numéro Pièce	Rev. 8	16
SEE BILL OF MATERIAL ON LAST PAGE		0

SEE BILL OF MATERIAL ON LAST PAGE **5412ESBU603616THC**

This drawing is confidential and must not be reproduced or used without the consent of EXM

Ce dessin est confidentiel et ne doit pas être reproduit ou utilisé sans le consentement de EXM

STANDARD FEATURES ARE NOT LISTED IN THIS HOLE TABLE

HOLE TABLE - FRONT VIEW (CUSTOM FEATURE ONLY)

CUT-OUT	XDIM	YDIM	DESCRIPTION
1	1.486	1.850	STUD M6 x 18mm (Inside)
2	1.486	57.953	STUD M6 x 18mm (Inside)
3	31.923	57.953	STUD M6 x 18mm (Inside)
4	31.923	1.850	STUD M6 x 18mm (Inside)
5	1.486	29.902	STUD M6 x 18mm (Inside)
6	31.923	29.902	STUD M6 x 18mm (Inside)
7	4.893	2.350	STUD M6 x 18mm (Inside)
8	4.893	57.619	STUD M6 x 18mm (Inside)
9	28.516	57.619	STUD M6 x 18mm (Inside)
10	28.516	2.350	STUD M6 x 18mm (Inside)
11	33.663	54.896	CLOSING BAR STUD (Inside)
12	33.663	4.907	CLOSING BAR STUD (Inside)
13	17.889	1.435	STUD M6 x 18mm (Inside)

14	33.663	29.902	885 ESL2A

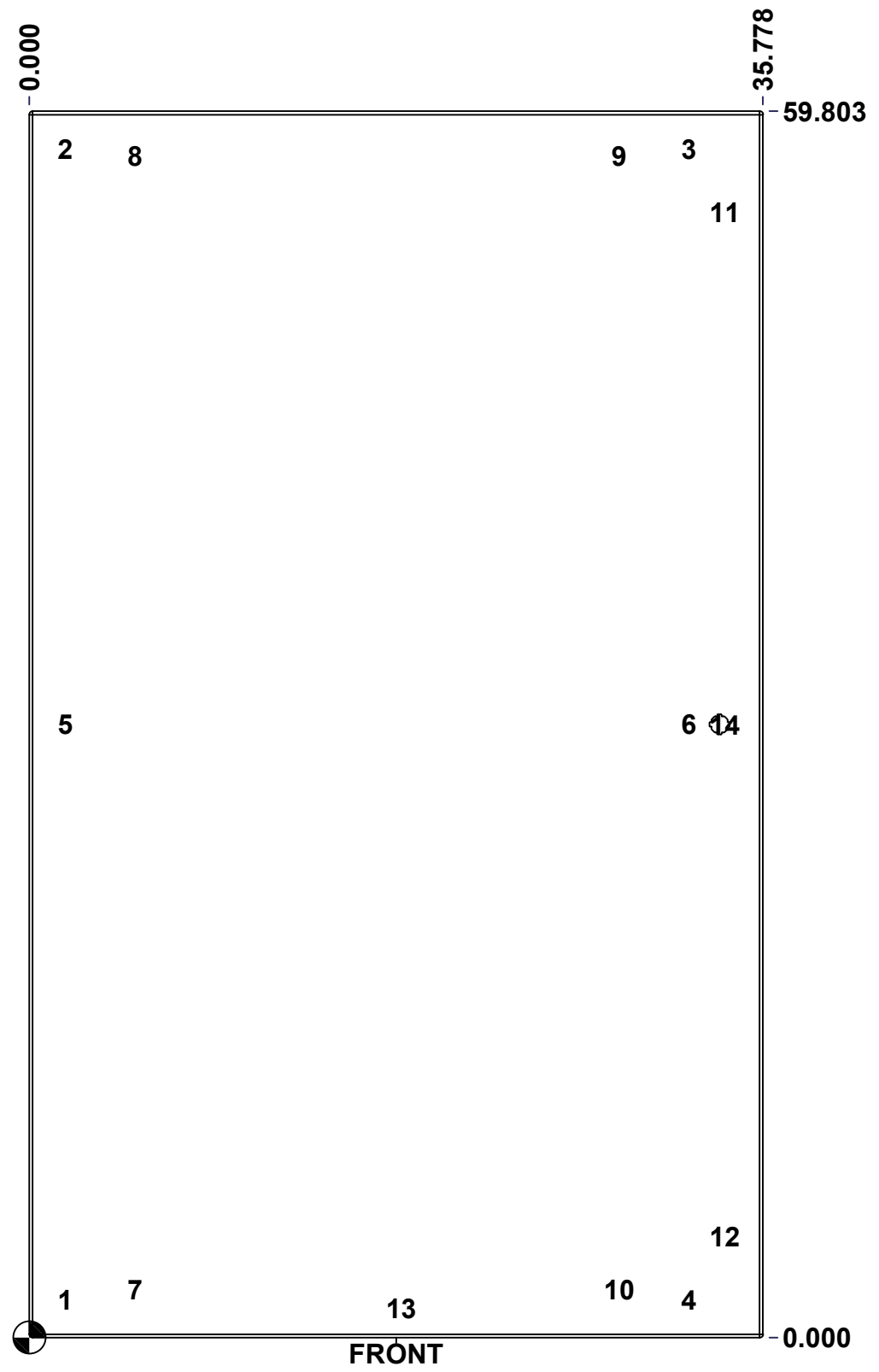

	Description	Status
	5412ESBU 60" x 36" Cover	(NULL)
	Part Number Numéro Pièce	Rev.
	5412ESBU603616THC	0
		9
		16

This drawing is confidential and must not be reproduced or used without the consent of EXM

Ce dessin est confidentiel et ne doit pas être reproduit ou utilisé sans le consentement de EXM

No.	Revisions	Date	By/Par

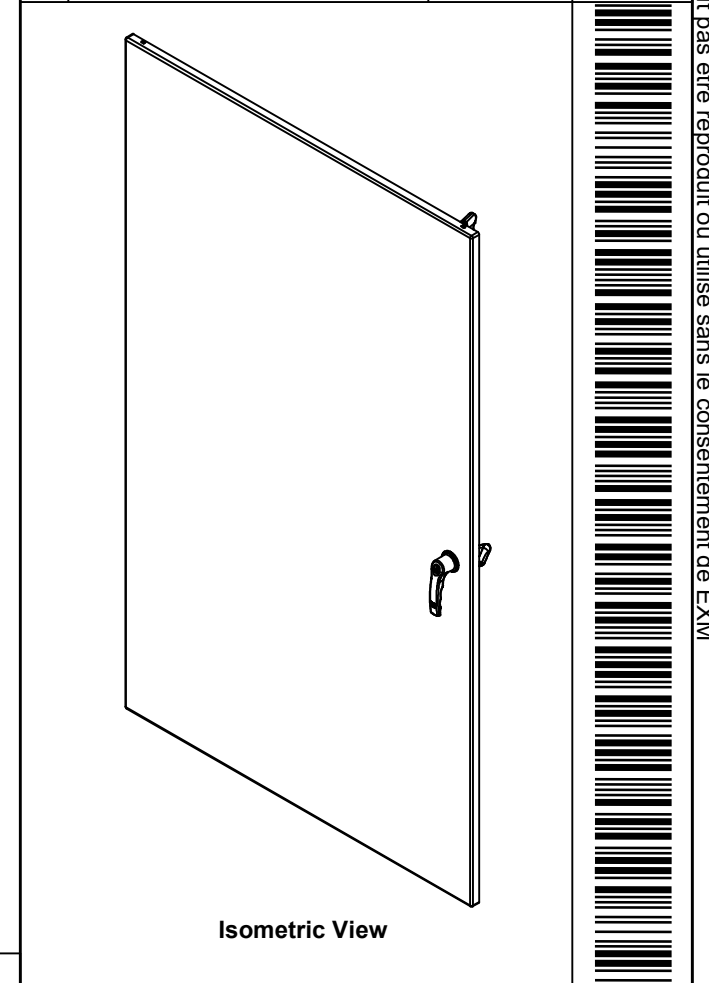

2	STK-Q-90042	4	5412 ES - Cabinet Closing Bar End (Small)
2	STK-Q-45655-60	0	5412 ES - Closing Bar
1	STK-Q-50536	13	5412 ES - Handle Cam Clockwise (Grip 32mm)
1	STK-Q-90051	3	5412 ES - Handle Cam Spacer
1	885 ESL2A	4	5412 ES Key Lock L-Handle (3 Pts)
2	STK-S-00100	0	3.5" x 2" Silver Milar Flexcon Sticker
10	STK-Q-07250	2	M6 x 16mm Collar Nut
2	STK-Q-46025-30-3	4	5412 ES Horizontal Door Stiffener 30" (3Pts)
2	STK-Q-46020-60	5	5412 ES Vertical Door Stiffener 60"
1	5412ESBU603616THI-C	0	5412ESBU 60" x 36" Cover Insulation
1	STK-P-02400S	0	Powder Paint (Asa-61 Grey / Smooth)
1	STK-Q-46515	3	5412 ES Door Support with Brass Insert
2	STK-Q-16405	6	Guide Stud - Small (No Paint Cap Required)
11	STK-Q-16055	1	M6 x 18mm Stud (No Paint Cap Required)
4	STK-A-33005	4	5412 ESBU Hinge 180° (Body Part)
1	5412ESBU603616THG	0	5412ESBU 60" x 36" Cover Gasket Part
1	5412ESBU603616THC-P	0	5412ESBU 60" x 36" Cover Part

QTY	Part Number	Rev	Description
Parts List			

 Tél: (450) 979-4373 Fax: (450) 979-4626 www.exmweb.com		Flatness Aplatissement	
		Max 3.0mm	
Customer Client		Date	
Drawn By Dessiné Par		Date 14-Apr-23	
Material Matière		14 Ga Cold Rolled A1008 CS Type B (1.7mm)	
Color Couleur		Asa-61 Grey	Finish Fini Smooth
Description			Detail Rev.
5412ESBU 60" x 36" Cover			
Part Number Numéro Pièce		Rev.	10
5412ESBU603616THC		0	16

This drawing is confidential and must not be reproduced or used without the consent of EXM

Ce dessin est confidentiel et ne doit pas être reproduit ou utilisé sans le consentement de EXM

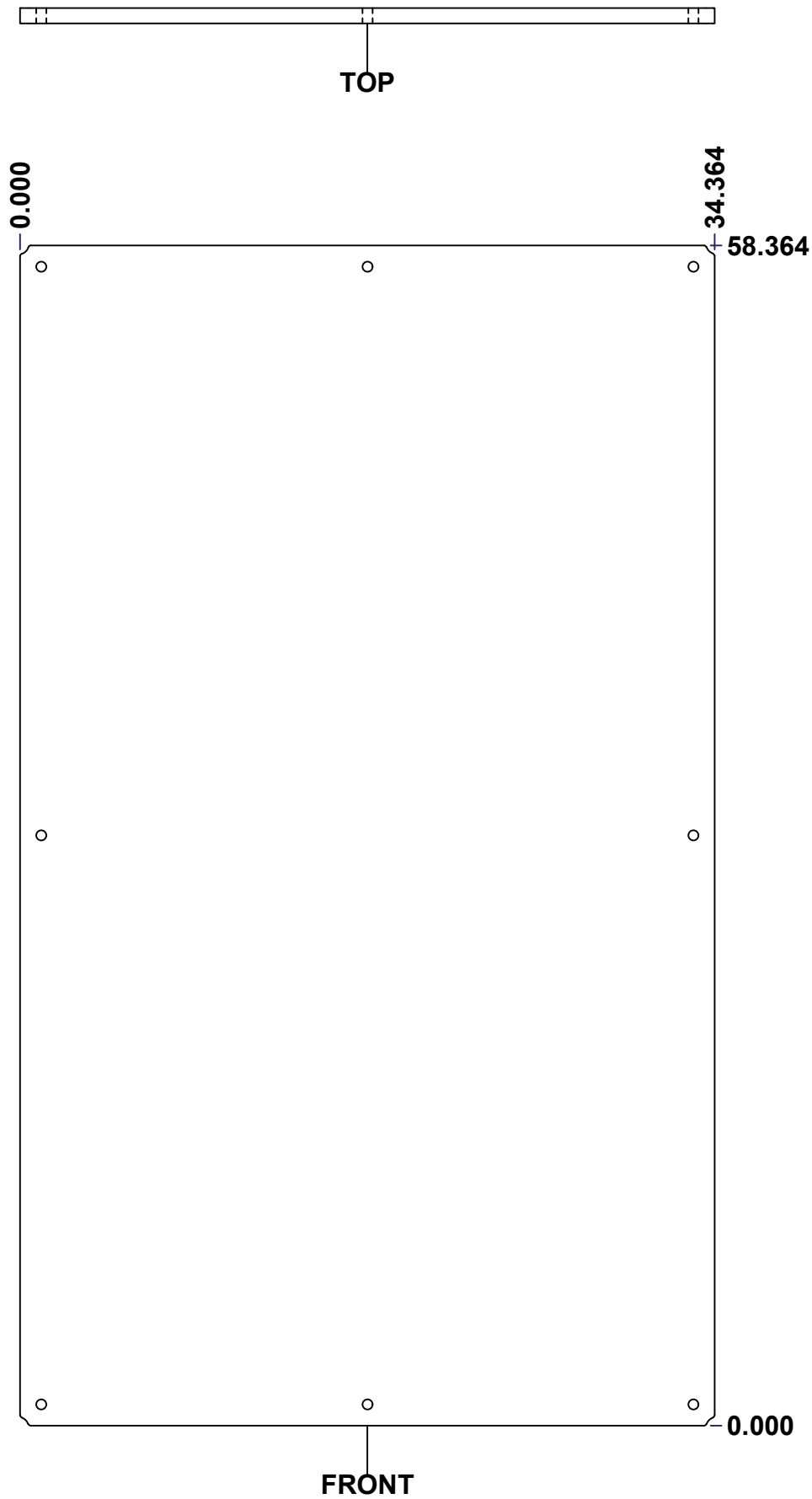

No.	Revisions	Date	By/Par

Isometric View

		Flatness Aplatissement Max 3.0mm	
Tél: (450) 979-4373 Fax: (450) 979-4626 www.exmweb.com		Projection 	
Customer Client		Date	
Drawn By Dessiné Par BoxCad: Patrick Deschenes		Date 23-Jan-07	
Material Matière Polyisocyanurate			
Color Couleur Aluminum	Finish Fini N/A		
Description 5412ESBU 60" x 36" Back Insulation			Detail Rev.
Part Number Numéro Pièce 5412ESBU603616THI-B		Rev. 0	11 / 16

SEE BILL OF MATERIAL ON LAST PAGE

This drawing is confidential and must not be reproduced or used without the consent of EXM

Ce dessin est confidentiel et ne doit pas être reproduit ou utilisé sans le consentement de EXM

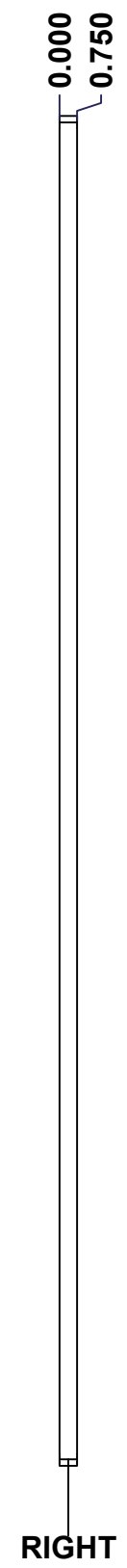
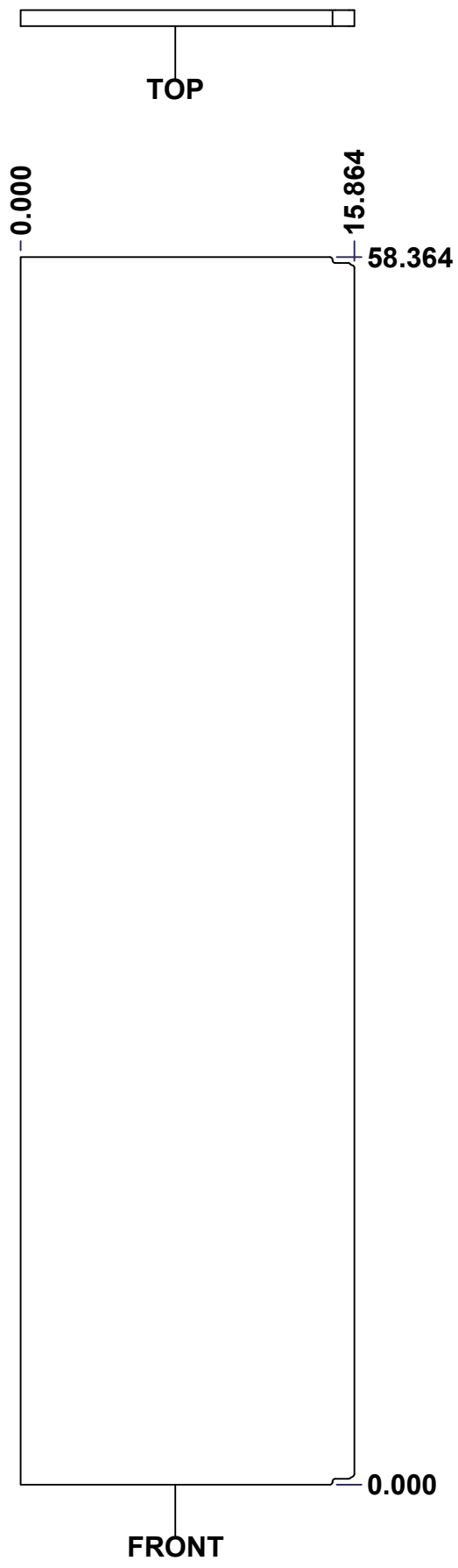

No.	Revisions	Date	By/Par

Isometric View

<p>Tél: (450) 979-4373 Fax: (450) 979-4626 www.exmweb.com</p>		Flatness Aplatissement
		Max 3.0mm
Projection		
Customer Client	Date	
Drawn By Dessiné Par	BoxCad: Patrick Deschenes	Date 23-Jan-07
Material Matière	Polyisocyanurate	
Color Couleur	Aluminum	Finish Fini N/A
Description	Detail Rev.	
5412ESBU 60" x 36" Left Insulation		
Part Number Numéro Pièce	Rev.	
5412ESBU603616THI-LS	0	12 / 16

SEE BILL OF MATERIAL ON LAST PAGE

This drawing is confidential and must not be reproduced or used without the consent of EXM

Ce dessin est confidentiel et ne doit pas être reproduit ou utilisé sans le consentement de EXM

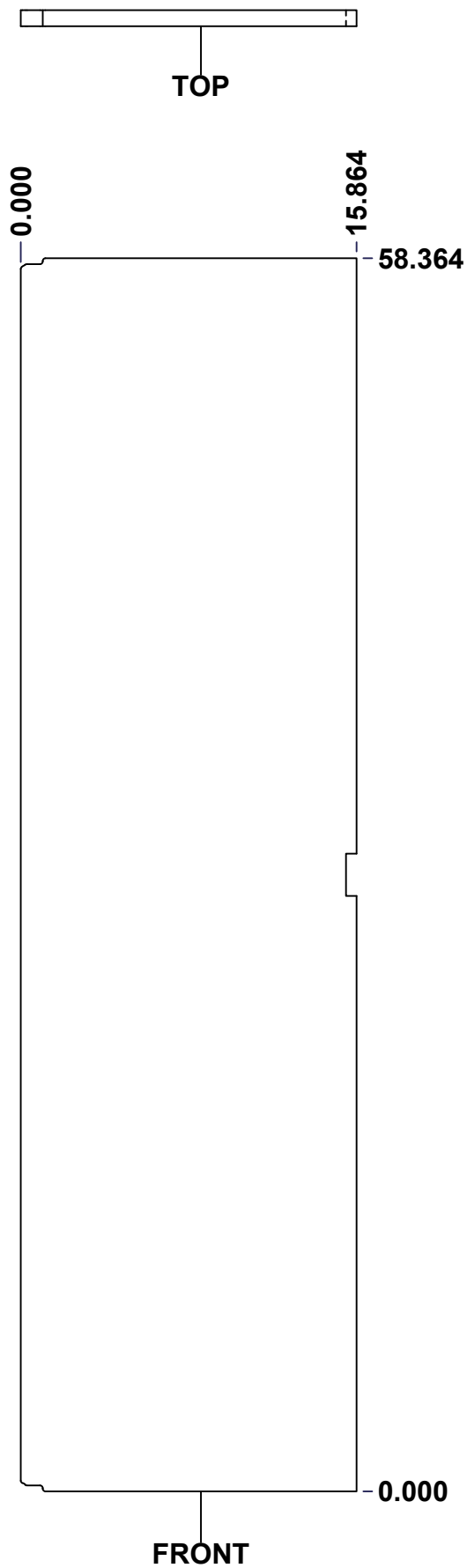

No.	Revisions	Date	By/Par

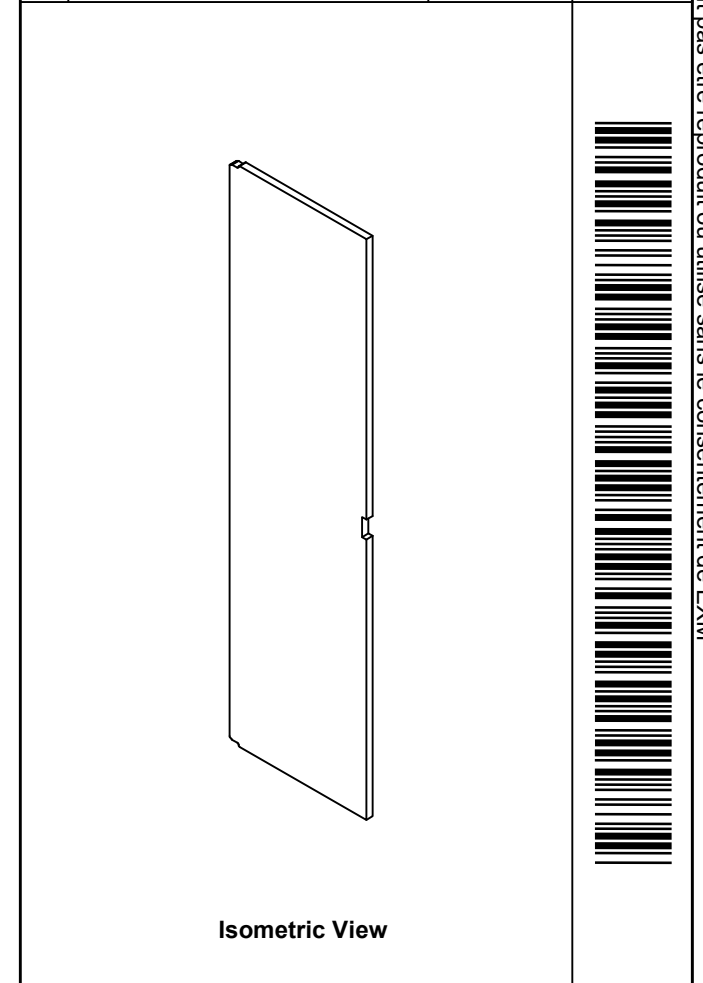

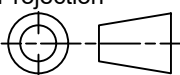
 Tél: (450) 979-4373 Fax: (450) 979-4626 www.exmweb.com		Flatness Aplatissement Max 3.0mm
Projection 		Date 23-Jan-07
Customer Client	Date	
Drawn By / Dessiné Par: BoxCad: Patrick Deschenes	Date: 23-Jan-07	
Material / Matière: Polyisocyanurate		
Color / Couleur: Aluminum	Finish / Fini: N/A	
Description: 5412ESBU 60" x 36" Right Insulation	Detail Rev.	
Part Number / Numéro Pièce: 5412ESBU603616THI-RS	Rev. 0	13 / 16

SEE BILL OF MATERIAL ON LAST PAGE

This drawing is confidential and must not be reproduced or used without the consent of EXM

Ce dessin est confidentiel et ne doit pas être reproduit ou utilisé sans le consentement de EXM

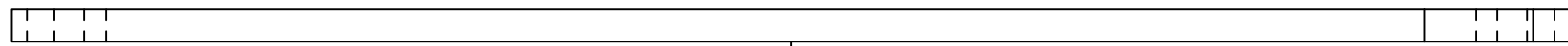

TOP

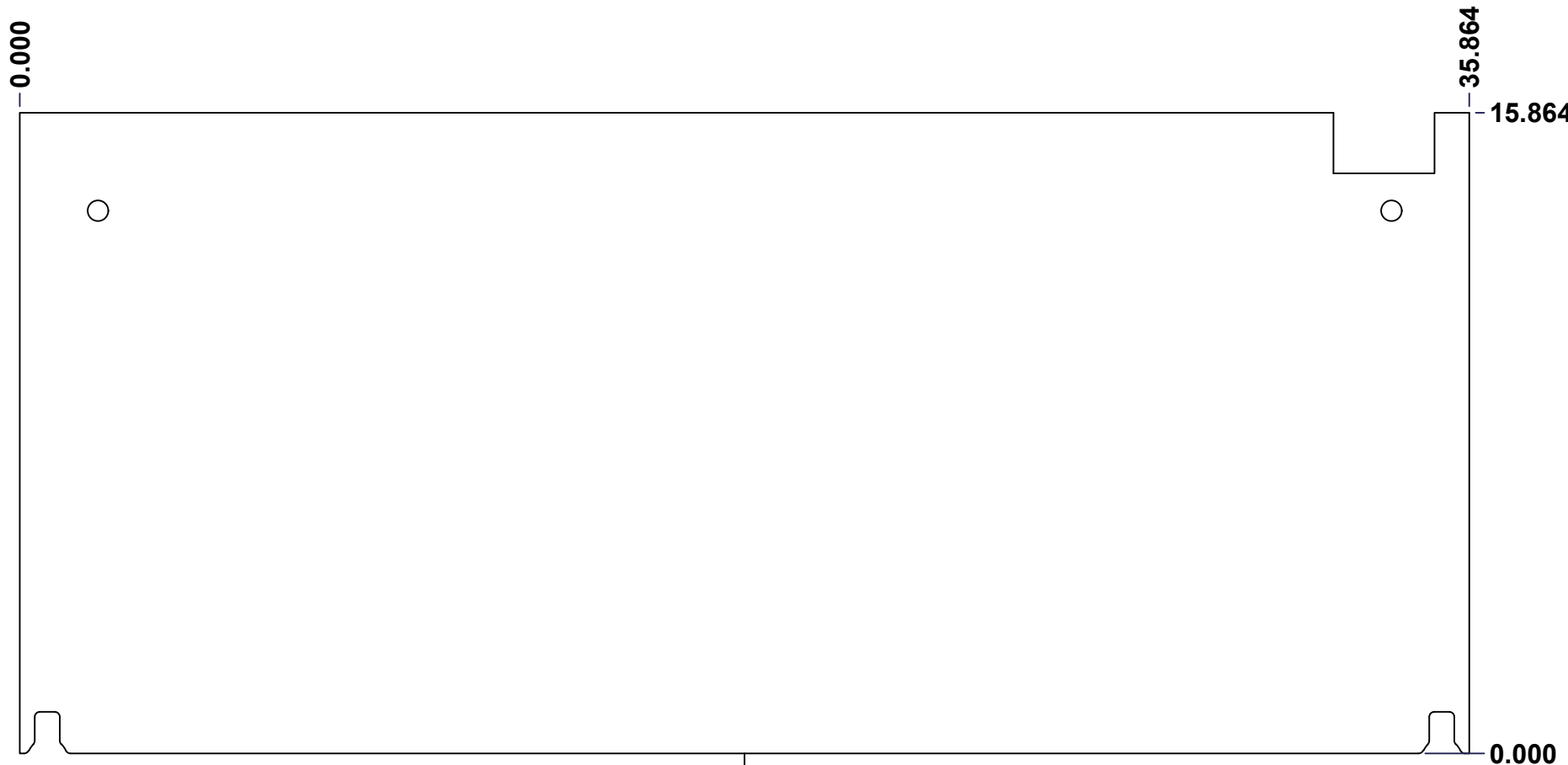

FRONT

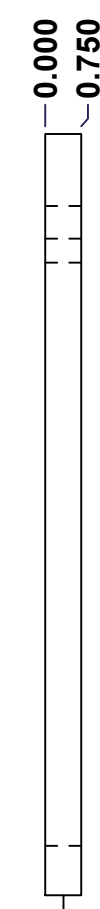

RIGHT

No.	Revisions	Date	By/Par

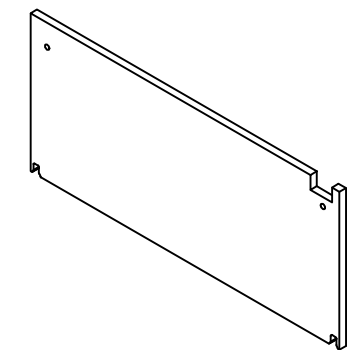

Isometric View



Tél: (450) 979-4373
 Fax: (450) 979-4626
www.exmweb.com

Flatness
Aplatissement
Max 3.0mm
Projection

Customer Client	Date
Drawn By / Dessiné Par: BoxCad: Patrick Deschenes	Date: 23-Jan-07
Material / Matière: Polyisocyanurate	
Color / Couleur: Aluminum	Finish / Fini: N/A
Description: 5412ESBU 60" x 36" Top and Bottom Insulation	Detail Rev.
Part Number / Numéro Pièce: 5412ESBU603616THI-TP	Rev. 0

SEE BILL OF MATERIAL ON LAST PAGE

This drawing is confidential and must not be reproduced or used without the consent of EXM

Ce dessin est confidentiel et ne doit pas être reproduit ou utilisé sans le consentement de EXM

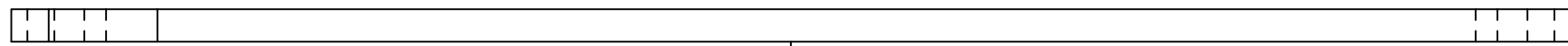

TOP



FRONT

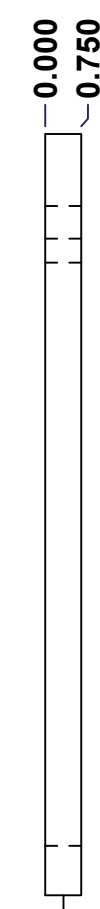

RIGHT

No.	Revisions	Date	By/Par

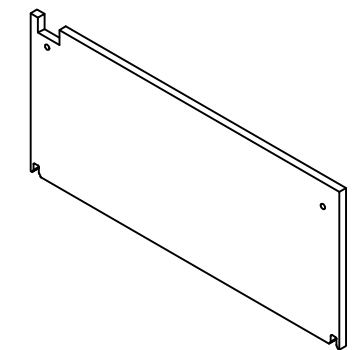

Isometric View



Tél: (450) 979-4373
 Fax: (450) 979-4626
www.exmweb.com

Flatness
Aplatissement
Max 3.0mm
Projection

Customer Client	Date
Drawn By / Dessiné Par: BoxCad: Patrick Deschenes	Date: 23-Jan-07
Material / Matière: Polyisocyanurate	
Color / Couleur: Aluminum	Finish / Fini: N/A
Description: 5412ESBU 60" x 36" Top and Bottom Insulation	Detail Rev.
Part Number / Numéro Pièce: 5412ESBU603616THI-BT	Rev. 0

SEE BILL OF MATERIAL ON LAST PAGE

This drawing is confidential and must not be reproduced or used without the consent of EXM

Ce dessin est confidentiel et ne doit pas être reproduit ou utilisé sans le consentement de EXM

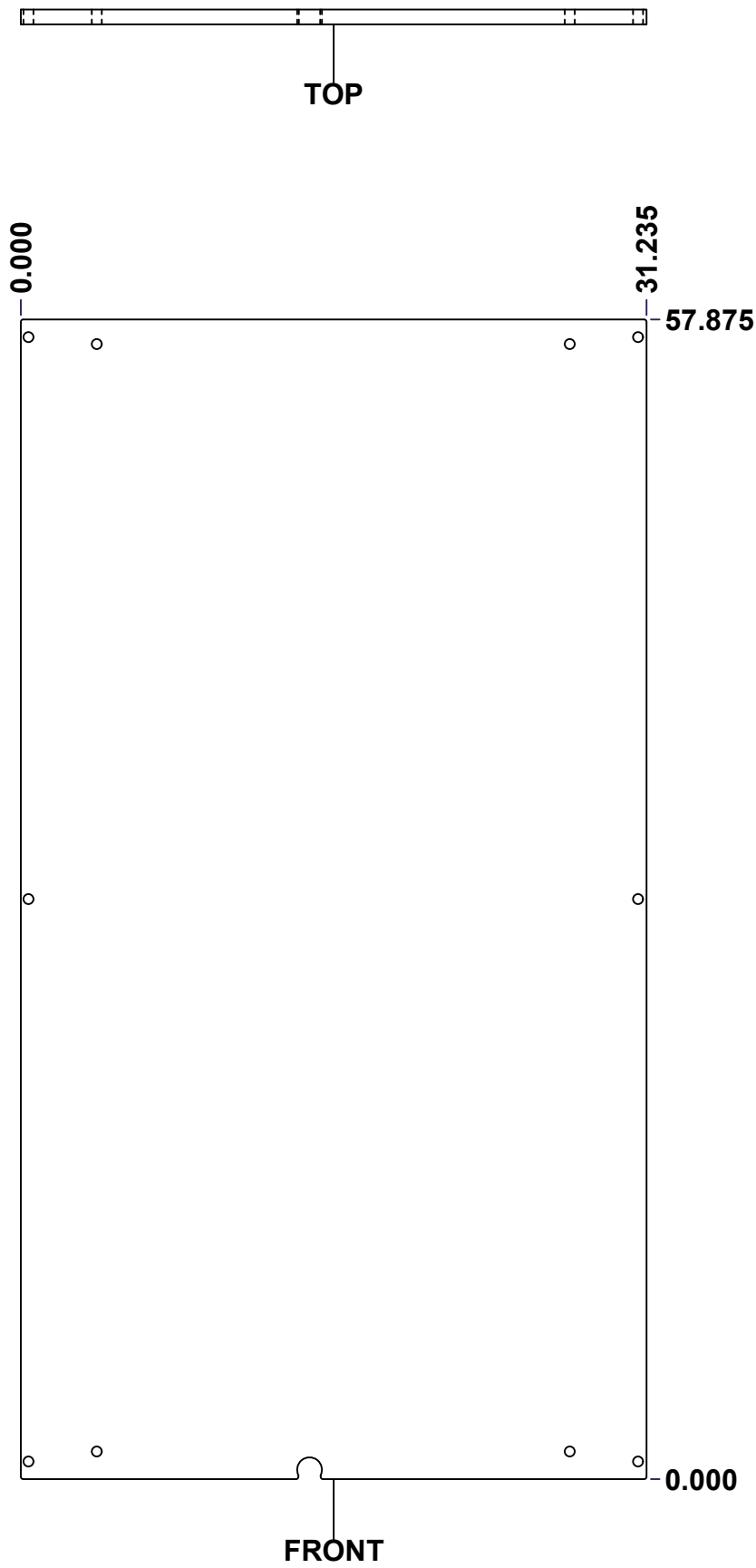

No.	Revisions	Date	By/Par

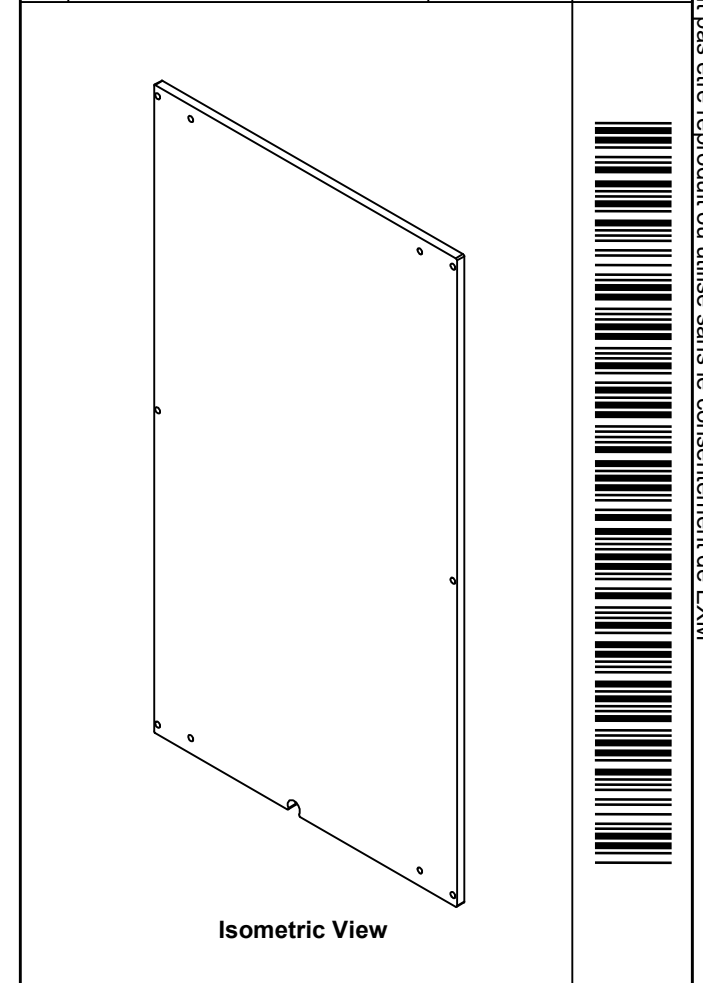

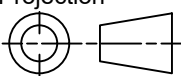
 Tél: (450) 979-4373 Fax: (450) 979-4626 www.exmweb.com		Flatness Aplatissement Max 3.0mm
Customer Client		Projection 
Drawn By / Dessiné Par: BoxCad: Patrick Deschenes		Date: 23-Jan-07
Material / Matière: Polyisocyanurate		
Color / Couleur: Aluminum	Finish / Fini: N/A	
Description: 5412ESBU 60" x 36" Cover Insulation		Detail Rev.
Part Number / Numéro Pièce: 5412ESBU603616THI-C		Rev. 0

SEE BILL OF MATERIAL ON LAST PAGE

This drawing is confidential and must not be reproduced or used without the consent of EXM

Ce dessin est confidentiel et ne doit pas être reproduit ou utilisé sans le consentement de EXM

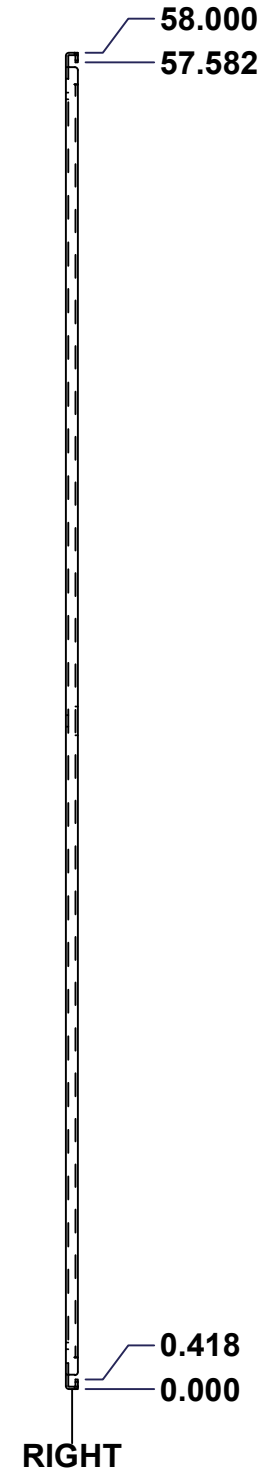
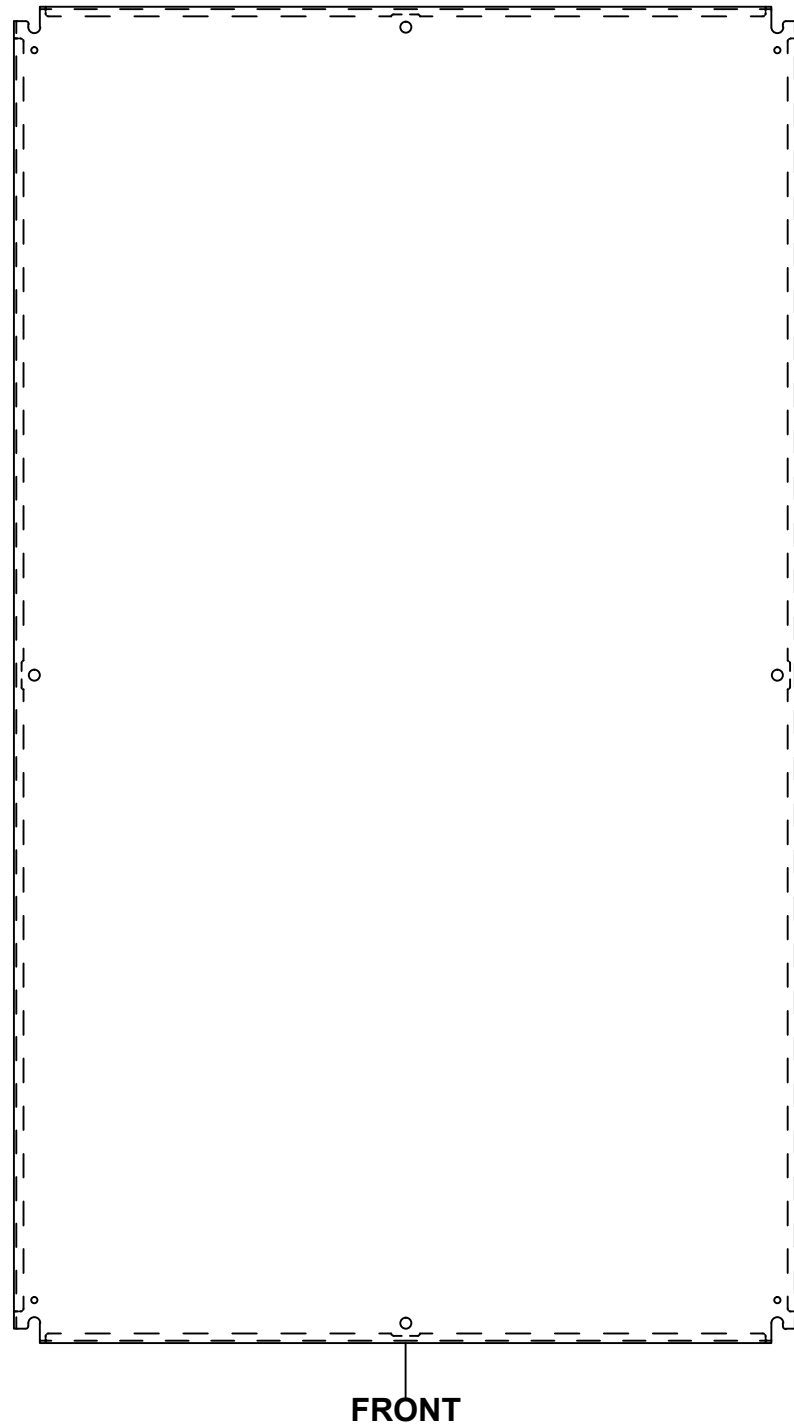
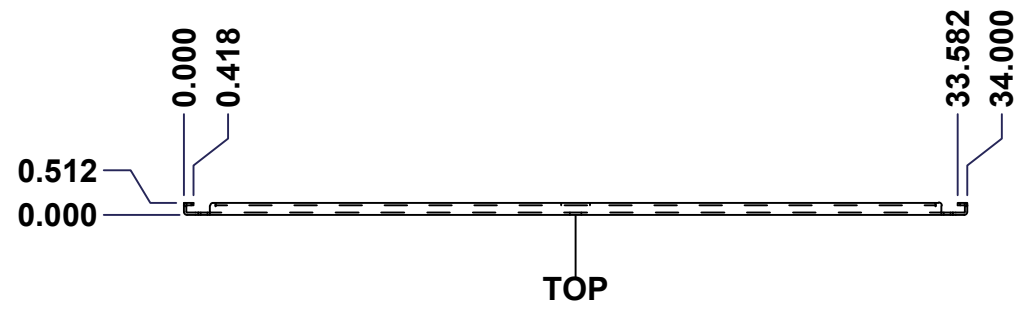

No.	Revisions	Date	By/Par

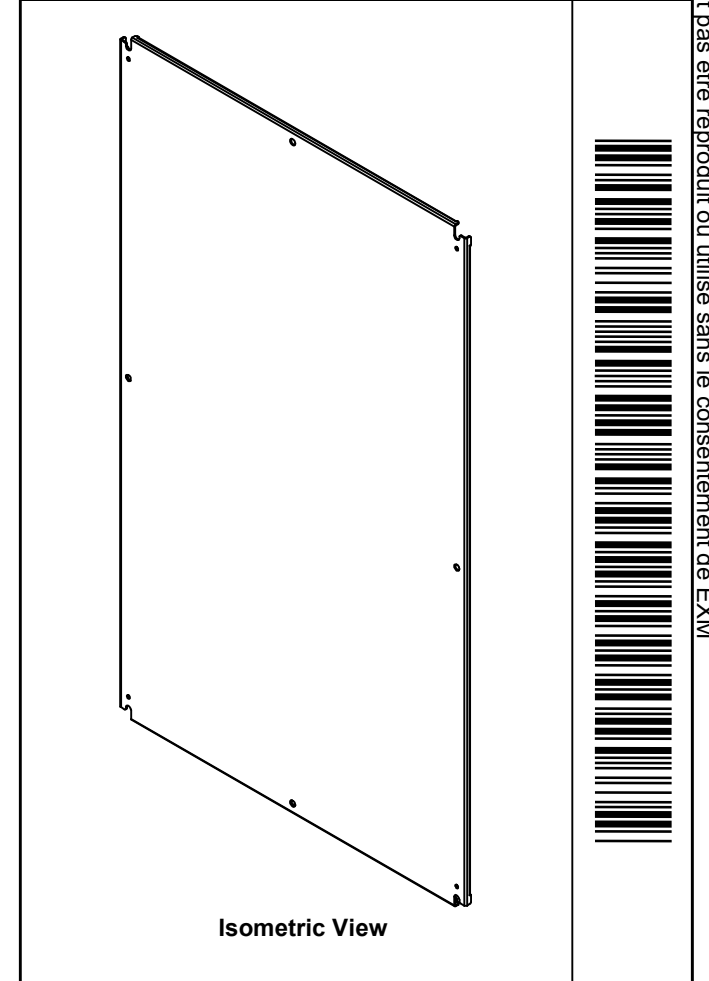

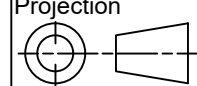
 Tél: (450) 979-4373 Fax: (450) 979-4626 www.exmweb.com		Flatness Aplatissement Max 3.0mm Projection 
Customer Client	Date	
Drawn By Dessiné Par: BoxCad	Date: 23-Jan-07	
Material Matière	See Part List	
Color Couleur	See Part List	Finish Fini: See Part List
Description	Detail Rev.	
881 SP - Inner Panel		
Part Number Numéro Pièce: 881 SP6036G	Rev. 0	1 2

Qty	Part Number	Rev	Description	Material	Color	Finish
1	881 SP6036G-P	0	881 SP - Inner Panel Part	12 Ga Galvanized	Unpainted	Galvanized

Parts List

This drawing is confidential and must not be reproduced or used without the consent of EXM

Ce dessin est confidentiel et ne doit pas être reproduit ou utilisé sans le consentement de EXM

Table 1			FRONT VIEW
CUT-OUT	XDIM	YDIM	DESCRIPTION
1	17.000	0.875	MTG STUD HOLE (RND Ø0.500)
2	0.875	29.000	MTG STUD HOLE (RND Ø0.500)
3	33.125	29.000	MTG STUD HOLE (RND Ø0.500)
4	17.000	57.125	MTG STUD HOLE (RND Ø0.500)
5	0.875	1.875	GROUND HOLE (RND Ø0.290)
6	33.125	1.875	GROUND HOLE (RND Ø0.290)
7	0.875	56.125	GROUND HOLE (RND Ø0.290)
8	33.125	56.125	GROUND HOLE (RND Ø0.290)

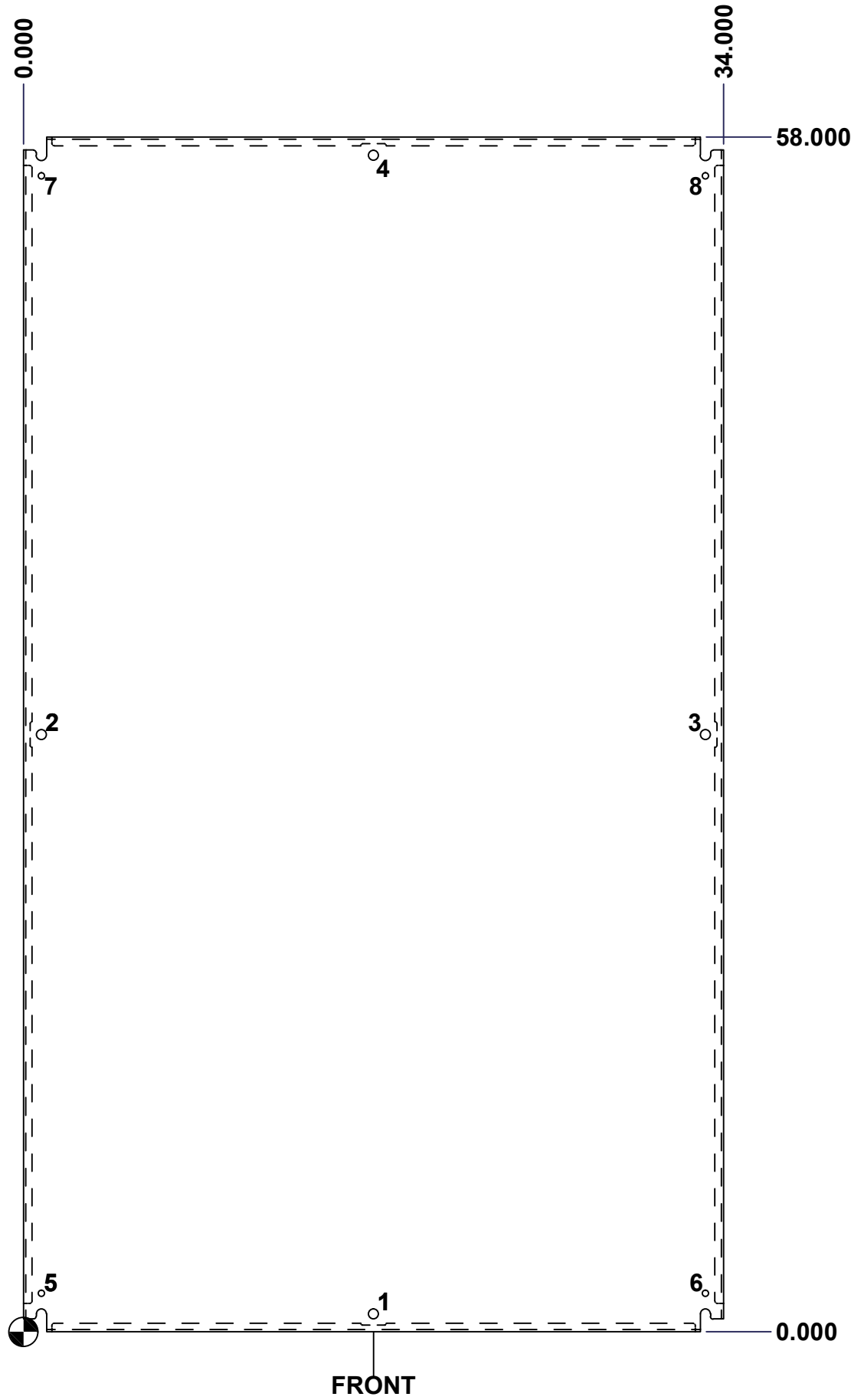

All knockouts are actual size / Les disques défonçables sont grandeur réel

No.	Revisions	Date	By/Par

Isometric View

		Tél: (450) 979-4373 Fax: (450) 979-4626 www.exmweb.com		Flatness Aplatissement Max 3.0mm	
Customer Client		Date		Projection 	
Drawn By Dessiné Par BoxCad		Date 23-Jan-07		Material Matière See Part List	
Color Couleur See Part List		Finish Fini See Part List		Description 881 SP - Inner Panel	
Part Number Numéro Pièce 881 SP6036G		Rev. 0		Detail Rev. 2	