

This drawing is confidential and must not be reproduced or used without the consent of EXM

Ce dessin est confidentiel et ne doit pas être reproduit ou utilisé sans le consentement de EXM

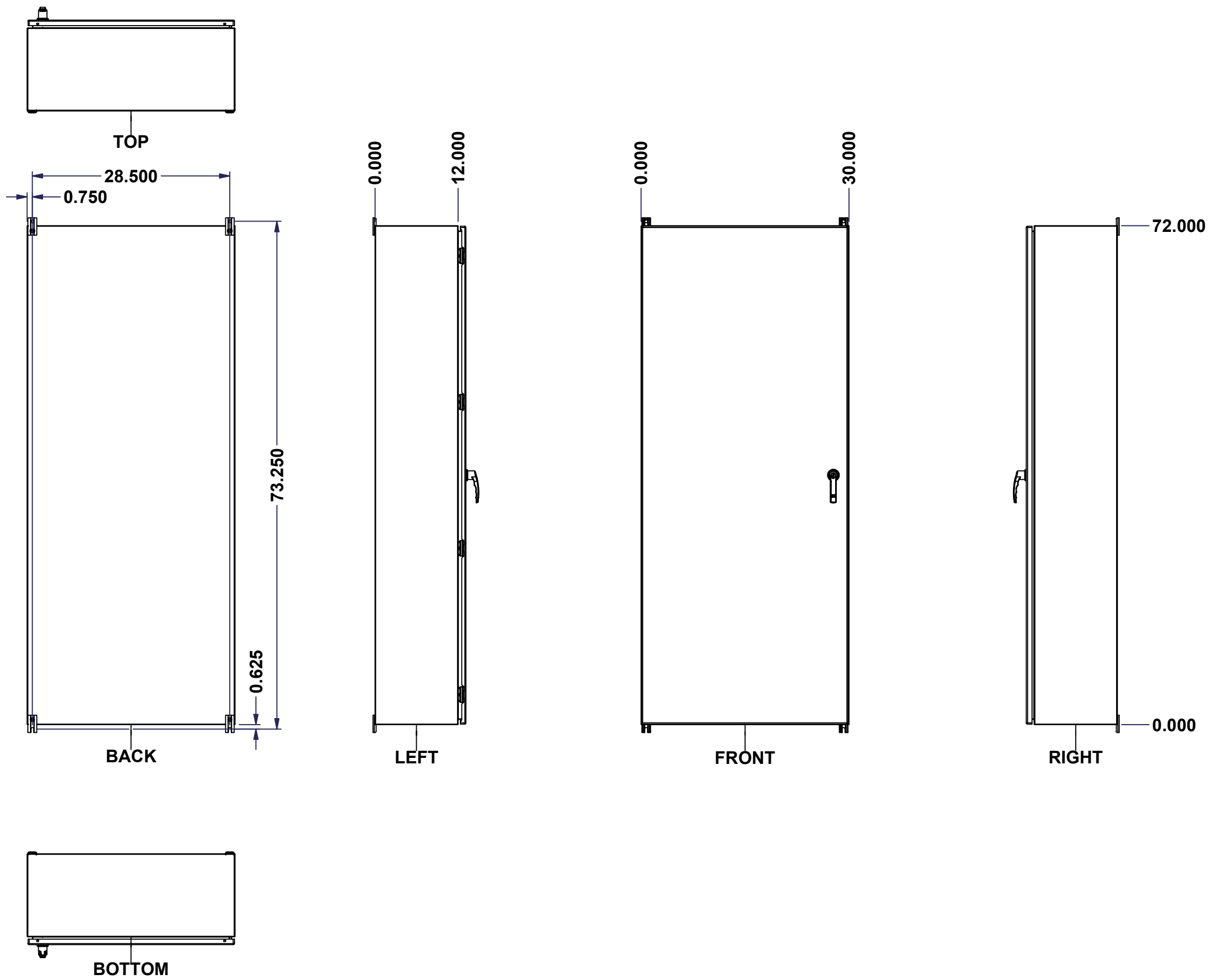

No.	Revisions	Date	By/Par

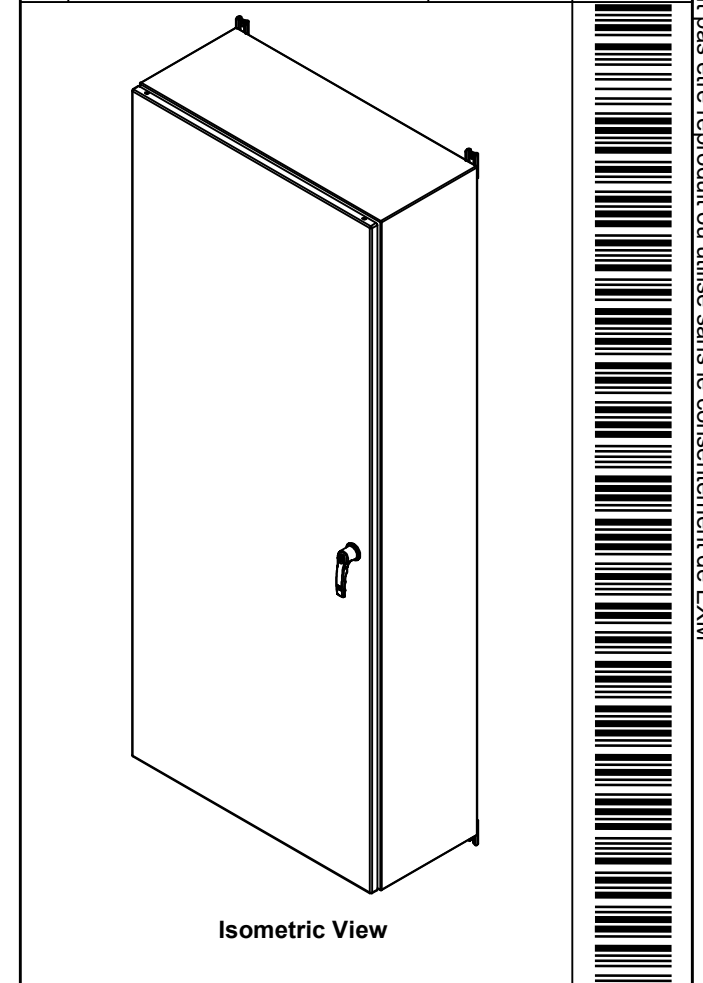

		Flatness / Aplatissement Max 3.0mm Projection 	
Customer / Client Drawn By / Dessiné Par: BoxCad: BoxCad Material / Matière: 14 Ga Cold Rolled A1008 CS Type B (1.7mm)		Date: 14-Apr-23 Contact: Tél: (450) 979-4373, Fax: (450) 979-4626, www.exmweb.com	
Color / Couleur: Asa-61 Grey Description: 5412ESBU 72" x 30" x 12" Assembly		Finish / Fini: Smooth Detail Rev.	
Part Number / Numéro Pièce: 5412ESBU723012THNOIP		Rev. 0	1 / 16

SEE BILL OF MATERIAL ON LAST PAGE

This drawing is confidential and must not be reproduced or used without the consent of EXM

Ce dessin est confidentiel et ne doit pas être reproduit ou utilisé sans le consentement de EXM

NOTE	
ITEM	DESCRIPTION
1	NEMA 4/12 Enclosure
2	C/W Standard ground studs on box and cover
3	C/W Standard door stiffener
4	W/O Inner panel
5	C/W Standard inner panel mounting studs
6	C/W 885 ESMF3_OPEN Sold separately (Installed)
7	C/W 885 ESMF3_CLOSE Sold separately (Installed)
8	C/W R5 Insulation (Installed by EXM)

No.	Revisions	Date	By/Par

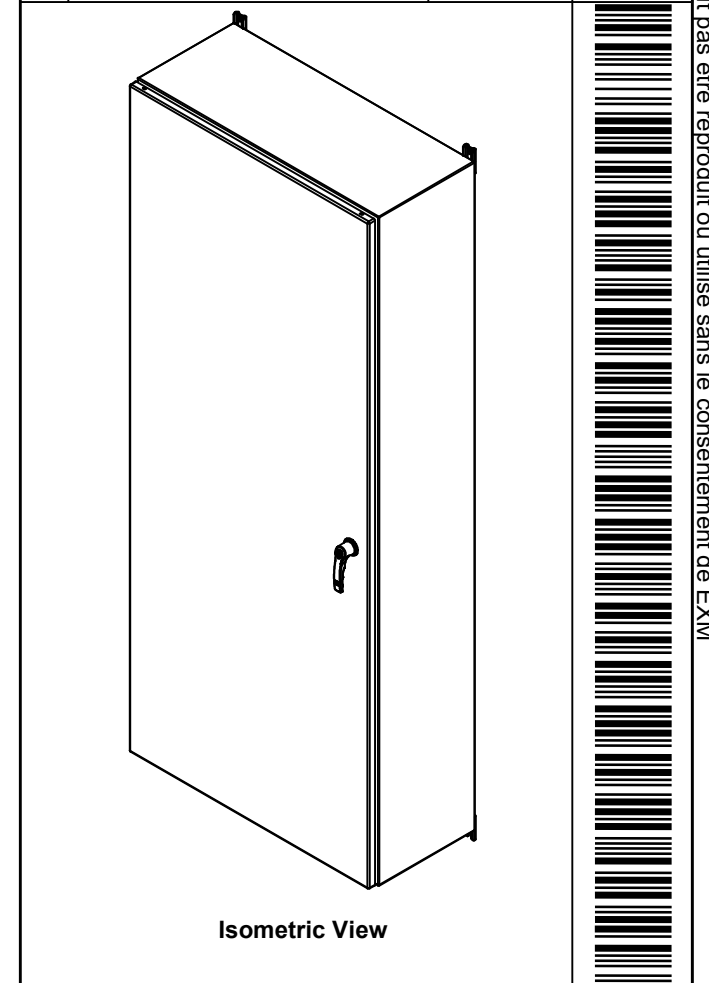

PACKING		
ITEM	QTY	DESCRIPTION
Cardboard sleeve	2	Top and Bottom
Cardboard strip	2	Between back of enclosure and inner panel
Plastic bag	1	To protect cover surface and inside gasket
Cardboard corner	4	To reinforced for the plastic strap tightening
Plastic strap - Black	2	To Squeeze the 2 cardboard sleeve together
Packaging label	3	White label with PN
Plastic strap- Green	2	To secure the enclosure to the wood pallet
Wood Pallet	1	2" deeper and 3" larger than enclosure size

6	STK-Q-00600	2	M12 to M8 Adaptor
1	STK-K-01800	5	5412 ES Accessory Kit
1	5412ESBU723012THNOI PC	0	5412ESBU 72" x 30" Cover
1	5412ESBU723012THNOI PB	0	5412ESBU 72" x 30" x 12" Body
8	STK-Q-04050-08	0	M6 x 8mm Hexagon Socket Head Machine Screw
Qty	Part Number	Rev	Description
Parts List			

		Flatness Aplatissement Max 3.0mm Projection
Tél: (450) 979-4373 Fax: (450) 979-4626 www.exmweb.com		Customer Client Date Drawn By Dessiné Par BoxCad: BoxCad Date 14-Apr-23
Material Matière 14 Ga Cold Rolled A1008 CS Type B (1.7mm)		Color Couleur Asa-61 Grey Finish Fini Smooth
Description 5412ESBU 72" x 30" x 12" Assembly		Detail Rev. Rev. 2 0
Part Number Numéro Pièce 5412ESBU723012THNOIP		Rev. 0 16

This drawing is confidential and must not be reproduced or used without the consent of EXM

Ce dessin est confidentiel et ne doit pas être reproduit ou utilisé sans le consentement de EXM

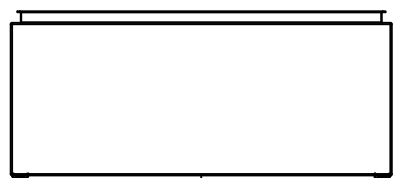

TOP

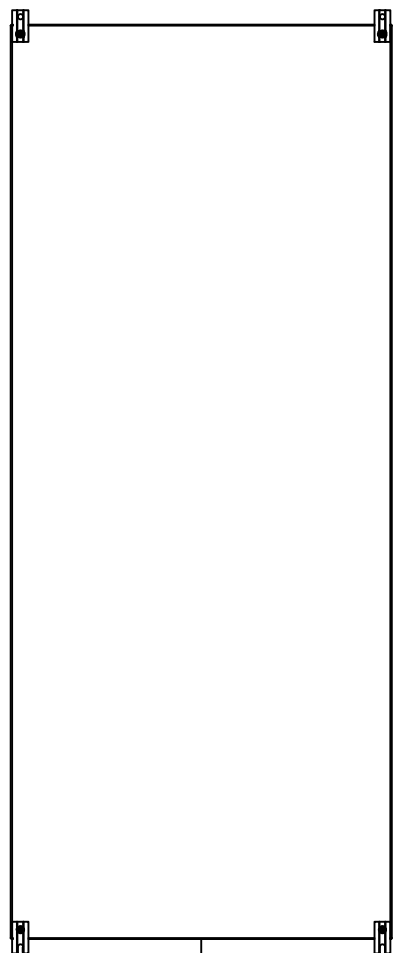

BACK

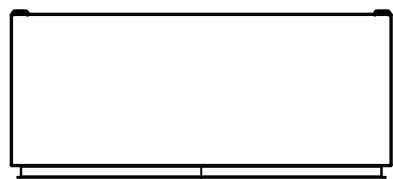

BOTTOM

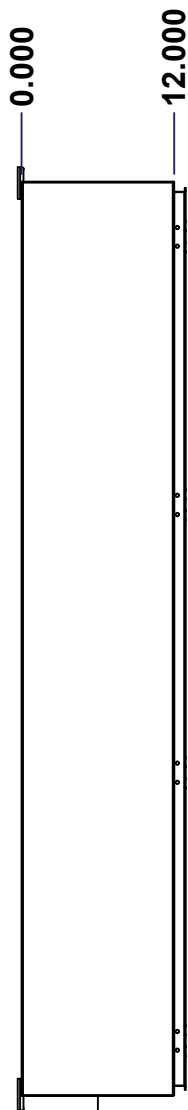

LEFT

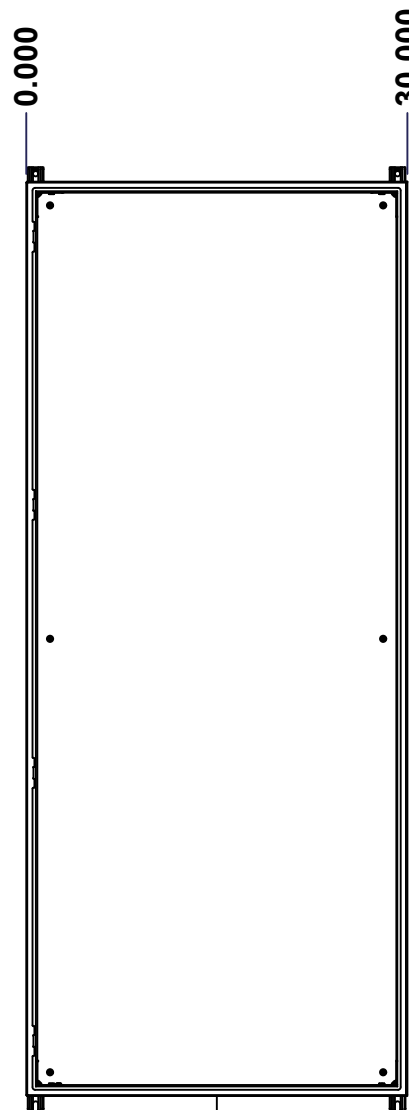

FRONT

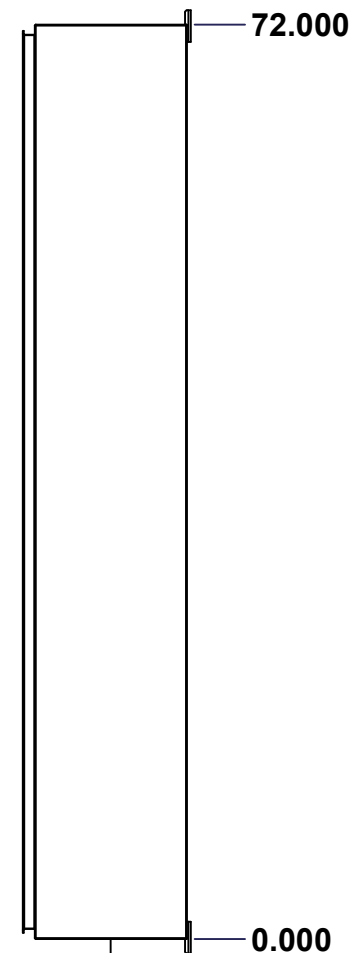

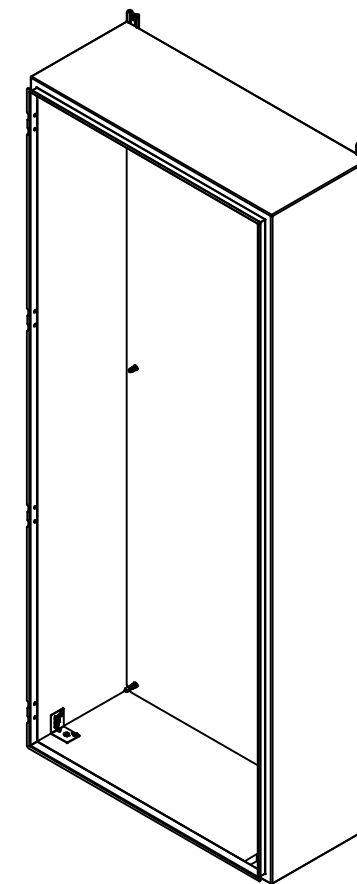

RIGHT



Isometric View

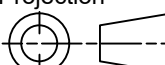

No.	Revisions	Date	By/Par

 Tél: (450) 979-4373 Fax: (450) 979-4626 www.exmweb.com		Flatness Aplatissement  Max 3.0mm Projection 
Customer Client	Date	
Drawn By Dessiné Par	BoxCad: BoxCad	Date 14-Apr-23
Material Matière	14 Ga Cold Rolled A1008 CS Type B (1.7mm)	
Color Couleur	Asa-61 Grey	Finish Fini Smooth
Description	Detail Rev.	
5412ESBU 72" x 30" x 12" Body		
Part Number Numéro Pièce	Rev. 0	3

SEE BILL OF MATERIAL ON LAST PAGE 5412ESBU723012THNOIPB

This drawing is confidential and must not be reproduced or used without the consent of EXM

Ce dessin est confidentiel et ne doit pas être reproduit ou utilisé sans le consentement de EXM

STANDARD FEATURES ARE NOT LISTED IN THIS HOLE TABLE			
HOLE TABLE - TOP VIEW (CUSTOM FEATURE ONLY)			
CUT-OUT	XDIM	YDIM	DESCRIPTION
1	2.000	9.500	INSUL. STUD M6 x 18mm (Inside)
2	28.000	9.500	INSUL. STUD M6 x 18mm (Inside)

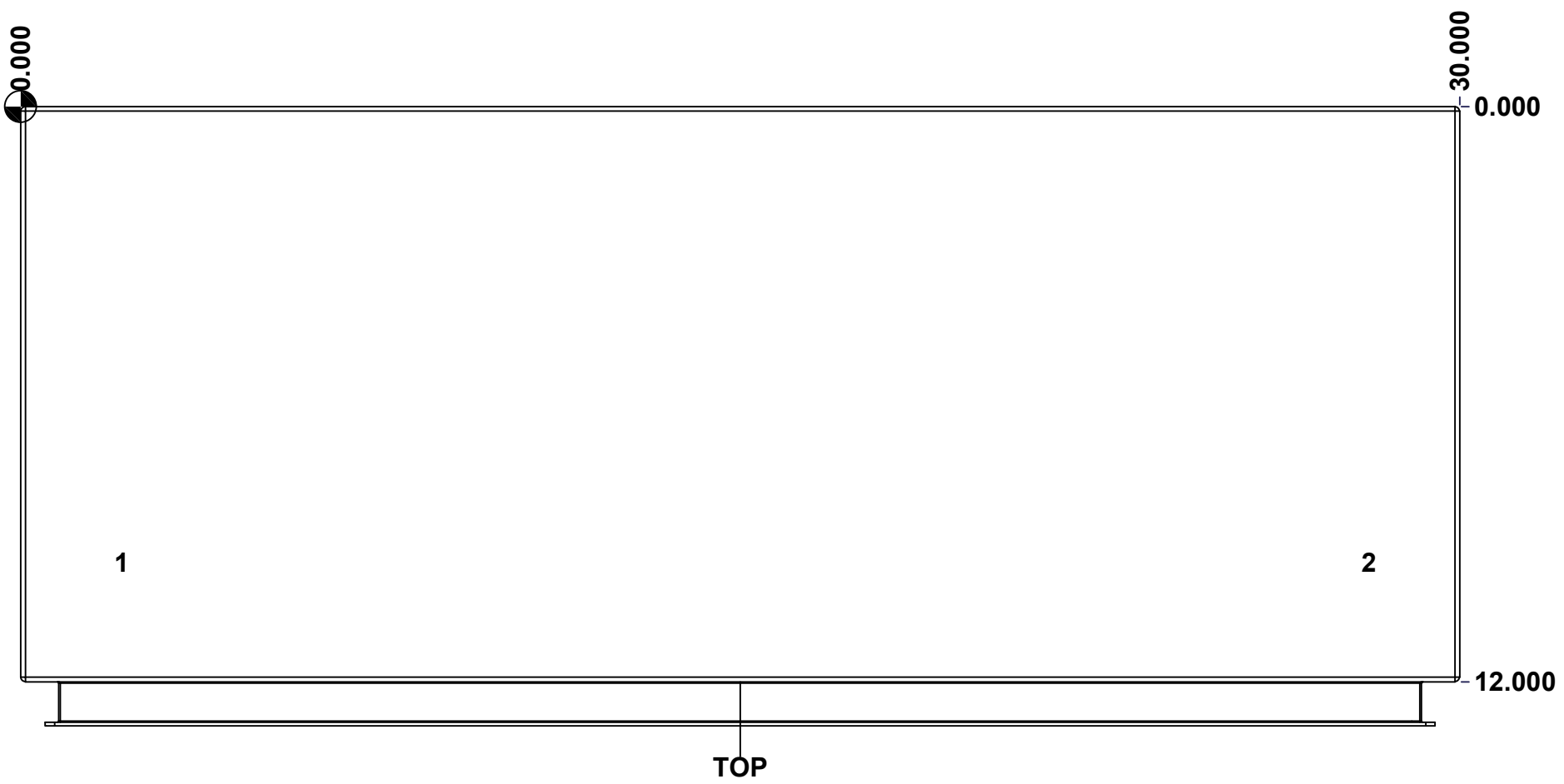

	Description	Status
	5412ESBU 72" x 30" x 12" Body	(NULL)
	Part Number Numéro Pièce	Rev.
	5412ESBU723012THNOIPB	0
		4
		16

This drawing is confidential and must not be reproduced or used without the consent of EXM

Ce dessin est confidentiel et ne doit pas être reproduit ou utilisé sans le consentement de EXM

STANDARD FEATURES ARE NOT LISTED IN THIS HOLE TABLE			
HOLE TABLE - BOTTOM VIEW (CUSTOM FEATURE ONLY)			
CUT-OUT	XDIM	YDIM	DESCRIPTION
1	2.000	9.500	INSUL. STUD M6 x 18mm (Inside)
2	28.000	9.500	INSUL. STUD M6 x 18mm (Inside)

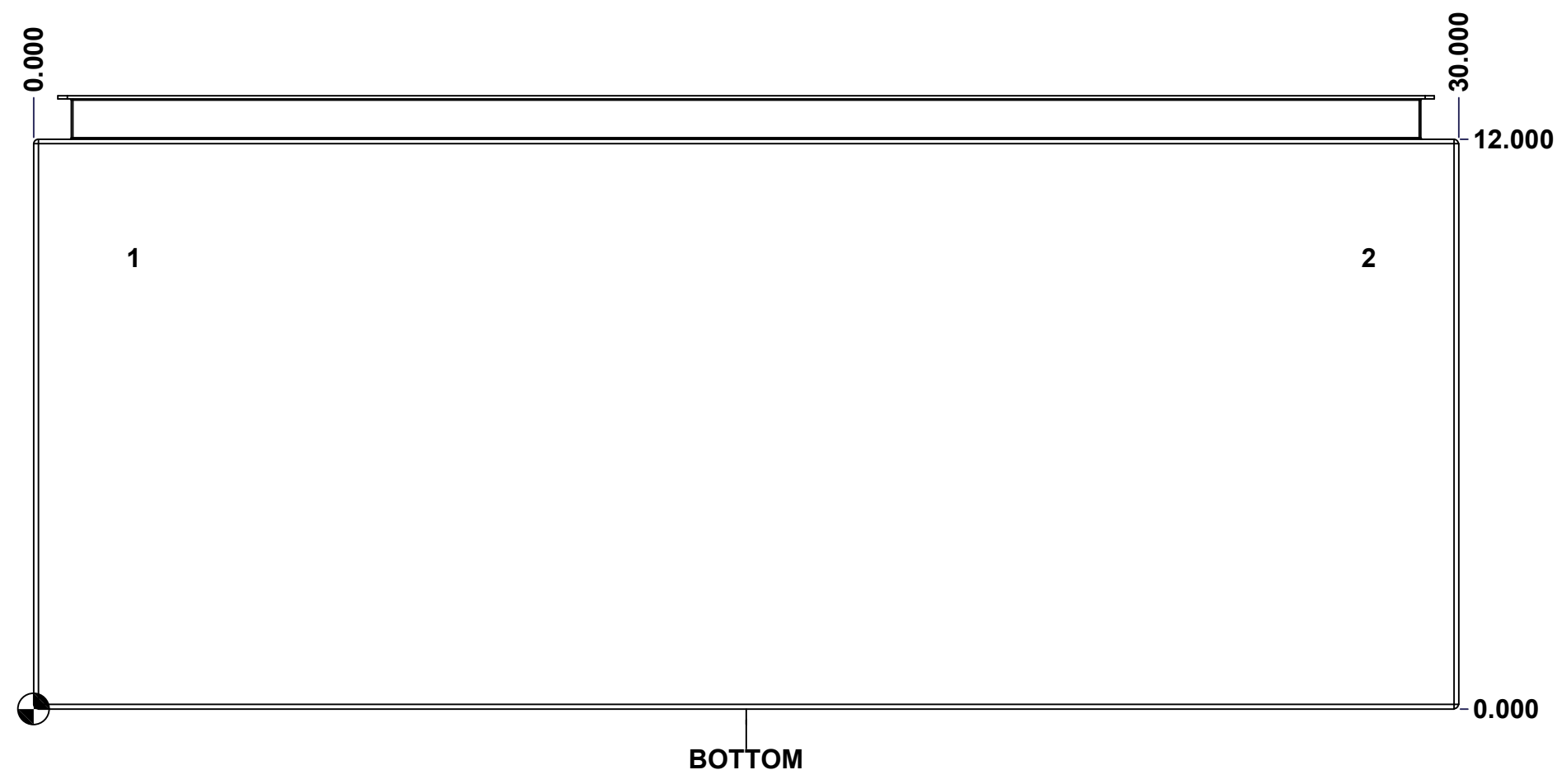

	Description	Status
	5412ESBU 72" x 30" x 12" Body	(NULL)
	Part Number Numéro Pièce	Rev.
	5412ESBU723012THNOIPB	0
		5
		16

This drawing is confidential and must not be reproduced or used without the consent of EXM

Ce dessin est confidentiel et ne doit pas être reproduit ou utilisé sans le consentement de EXM

STANDARD FEATURES ARE NOT LISTED IN THIS HOLE TABLE

HOLE TABLE - BACK VIEW (CUSTOM FEATURE ONLY)

CUT-OUT	XDIM	YDIM	DESCRIPTION
1	1.875	1.875	IP STUD M8 x 35mm (Inside)
2	1.875	70.125	IP STUD M8 x 35mm (Inside)
3	28.125	70.125	IP STUD M8 x 35mm (Inside)
4	28.125	1.875	IP STUD M8 x 35mm (Inside)
5	1.875	36.000	IP STUD M8 x 35mm (Inside)
6	28.125	36.000	IP STUD M8 x 35mm (Inside)

7	29.250	0.000	FOOT 885 ESMF3_OPEN
8	0.750	0.000	FOOT 885 ESMF3_OPEN
9	29.250	72.000	FOOT 885 ESMF3_CLOSE
10	0.750	72.000	FOOT 885 ESMF3_CLOSE

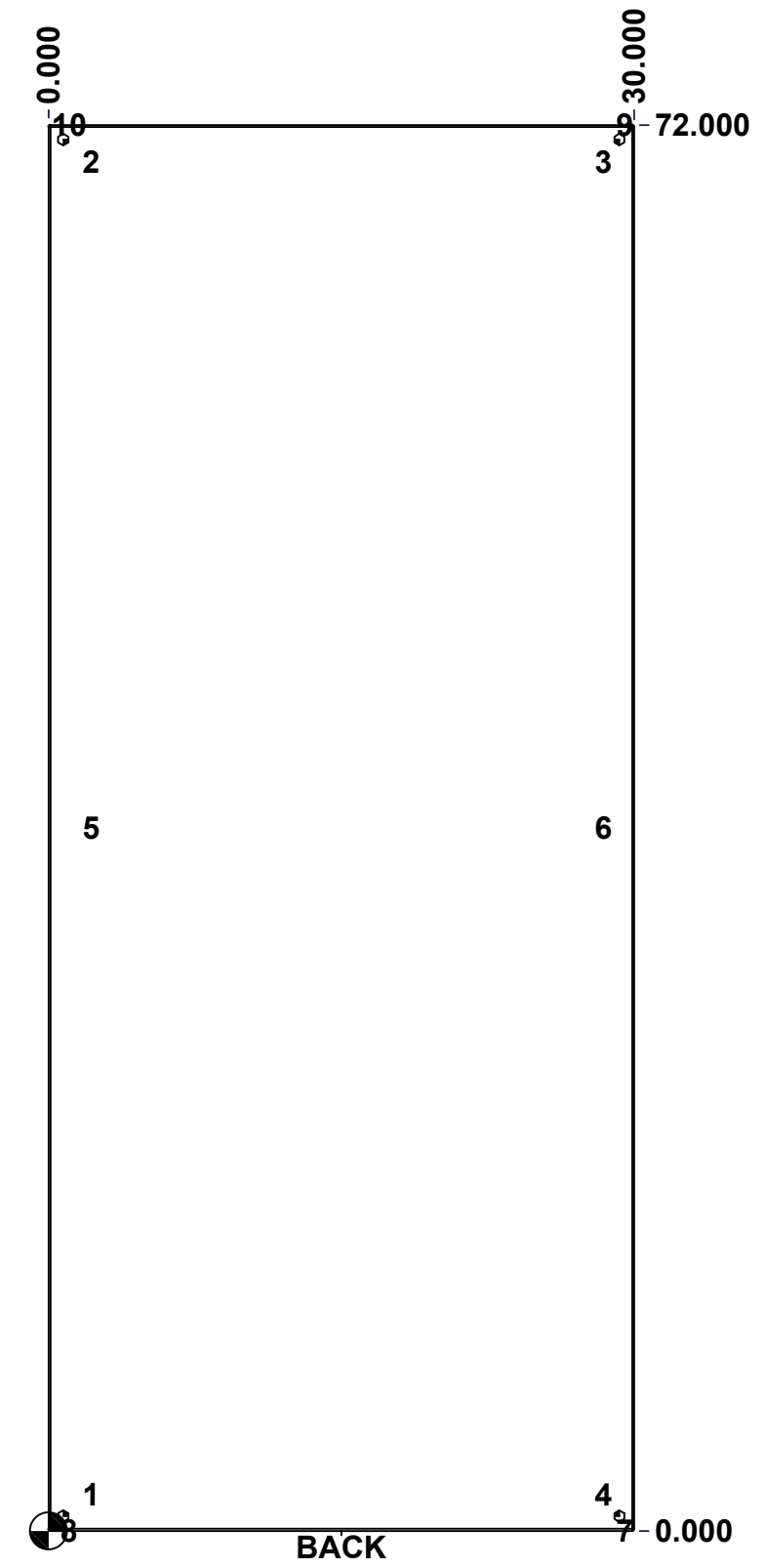

	Description	Status
	5412ESBU 72" x 30" x 12" Body	(NULL)
Part Number Numéro Pièce 5412ESBU723012THNOIPB	Rev.	6
	0	16

This drawing is confidential and must not be reproduced or used without the consent of EXM

Ce dessin est confidentiel et ne doit pas être reproduit ou utilisé sans le consentement de EXM

No.	Revisions	Date	By/Par

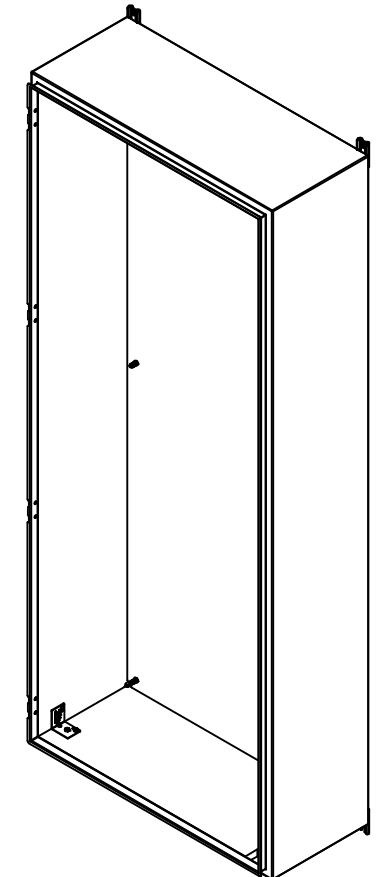

Isometric View

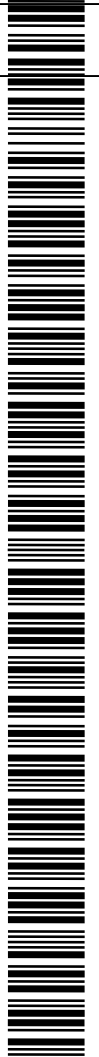

2	885ESMF3-FEET	0	885 ESMF3 Mounting Foot
4	RIVET_NUT_M10_FH_CE	0	Rivet Nut M10 (Low Profile Close End)
4	STK-Q-06660	2	M10 x 16mm Machine Screw
2	885ESMF3-FEET-A	0	885 ESMF3 Mounting Foot (Opened Slot)
1	STK-K-70554	3	5412 ESTH Accessory Kit
1	5412ESBU723012THNOI PI-RS	0	5412ESBU 72" x 30" Right Insulation
1	5412ESBU723012THNOI PI-LS	0	5412ESBU 72" x 30" Left Insulation
1	5412ESBU723012THNOI PI-BT	0	5412ESBU 72" x 30" Top and Bottom Insulation
1	5412ESBU723012THNOI PI-TP	0	5412ESBU 72" x 30" Top and Bottom Insulation
1	5412ESBU723012THNOI PI-B	0	5412ESBU 72" x 30" Back Insulation
4	STK-Q-16055	1	M6 x 18mm Stud (No Paint Cap Required)
1	STK-P-02400S	0	Powder Paint (Asa-61 Grey / Smooth)
6	STK-Q-16005	1	Stud M8 x 35 (No Paint Cap Required)
1	5412ESBU723012THNOI PB-P	0	5412ESBU 72" x 30" x 12" Body Part

Qty	Part Number	Rev	Description
Parts List			

	Tél: (450) 979-4373 Fax: (450) 979-4626 www.exmweb.com	Flatness Aplatissement Max 3.0mm
	Projection 	Customer Client
Drawn By Dessiné Par	BoxCad: BoxCad	Date 14-Apr-23
Material Matière	14 Ga Cold Rolled A1008 CS Type B (1.7mm)	
Color Couleur	Asa-61 Grey	Finish Fini Smooth
Description 5412ESBU 72" x 30" x 12" Body		Detail Rev.
Part Number Numéro Pièce 5412ESBU723012THNOIPB		Rev. 7 0

This drawing is confidential and must not be reproduced or used without the consent of EXM

Ce dessin est confidentiel et ne doit pas être reproduit ou utilisé sans le consentement de EXM

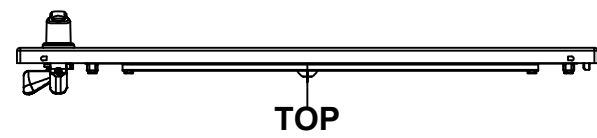

TOP

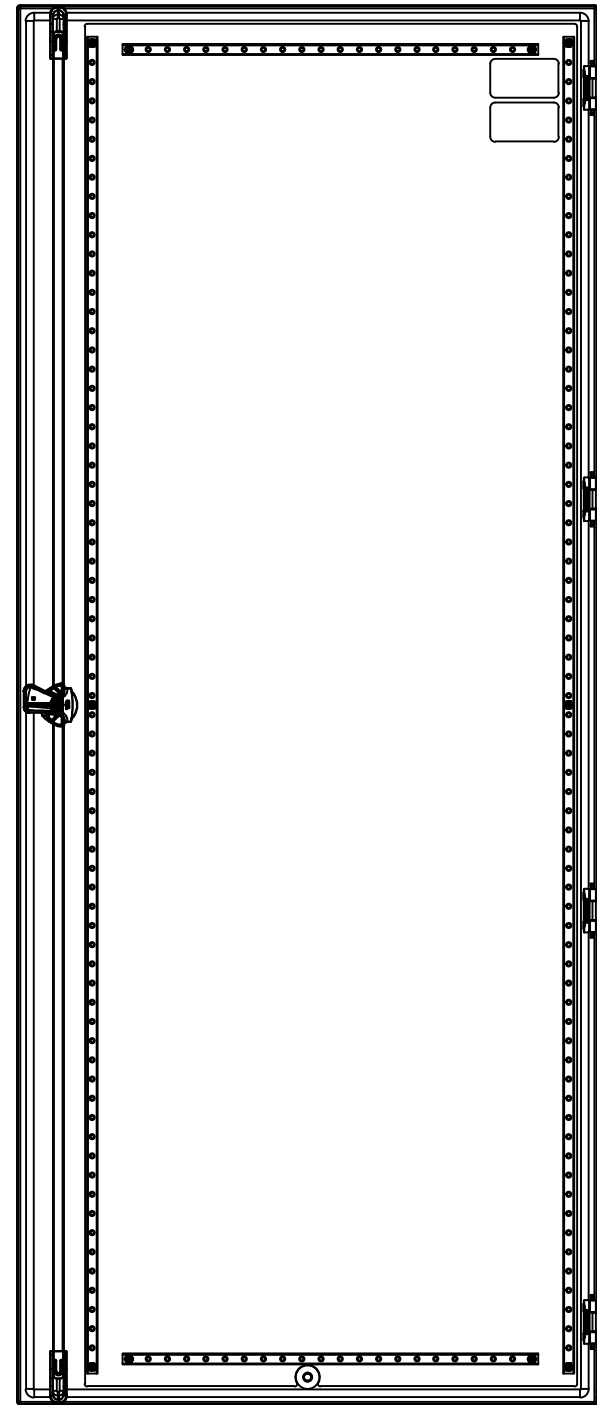

BACK

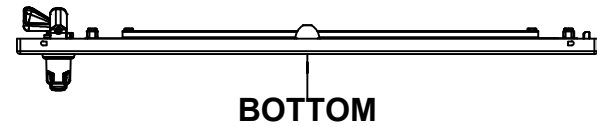

BOTTOM

0.000
0.800

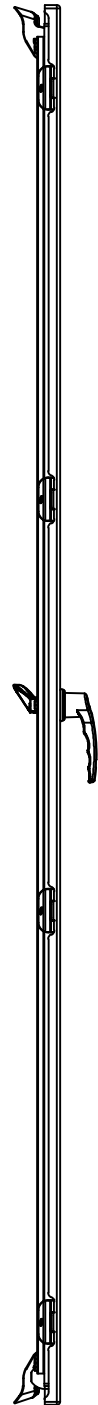

LEFT

0.000

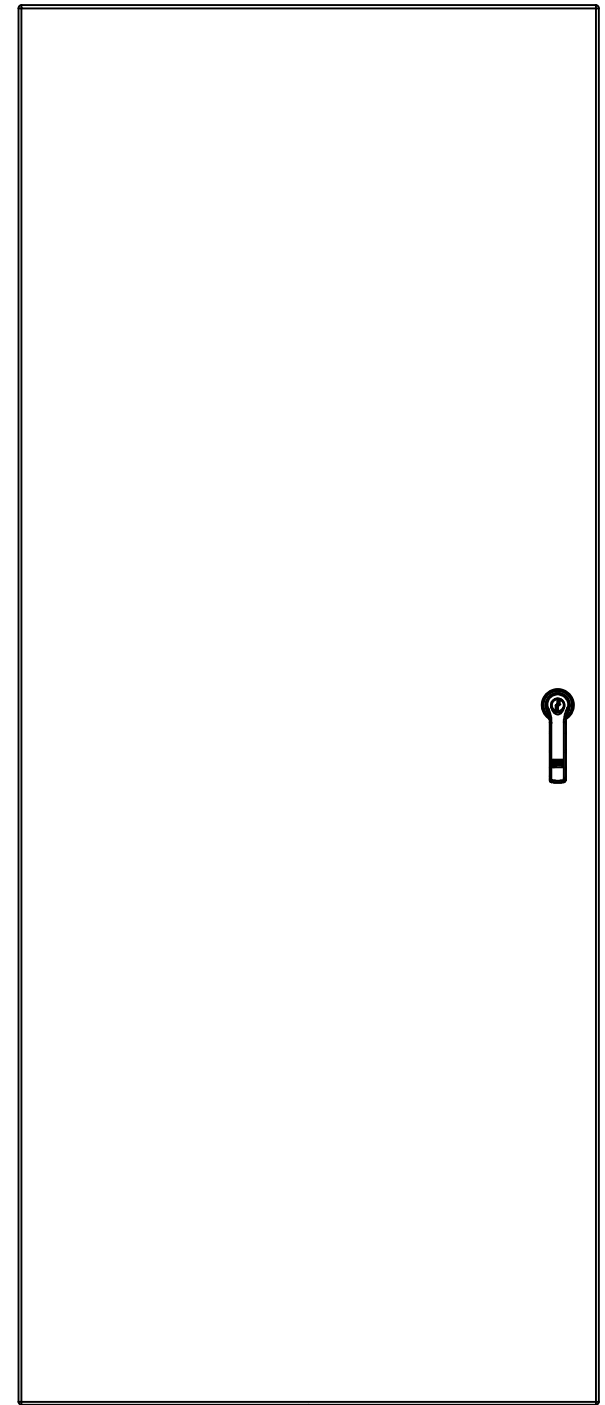

FRONT

29.778

71.803

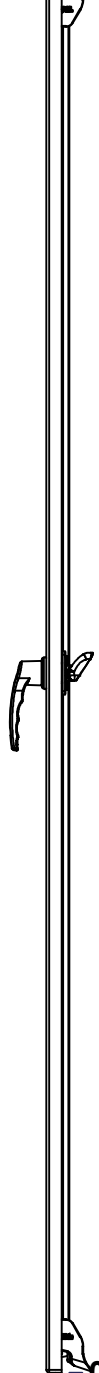

RIGHT

0.000

No.	Revisions	Date	By/Par

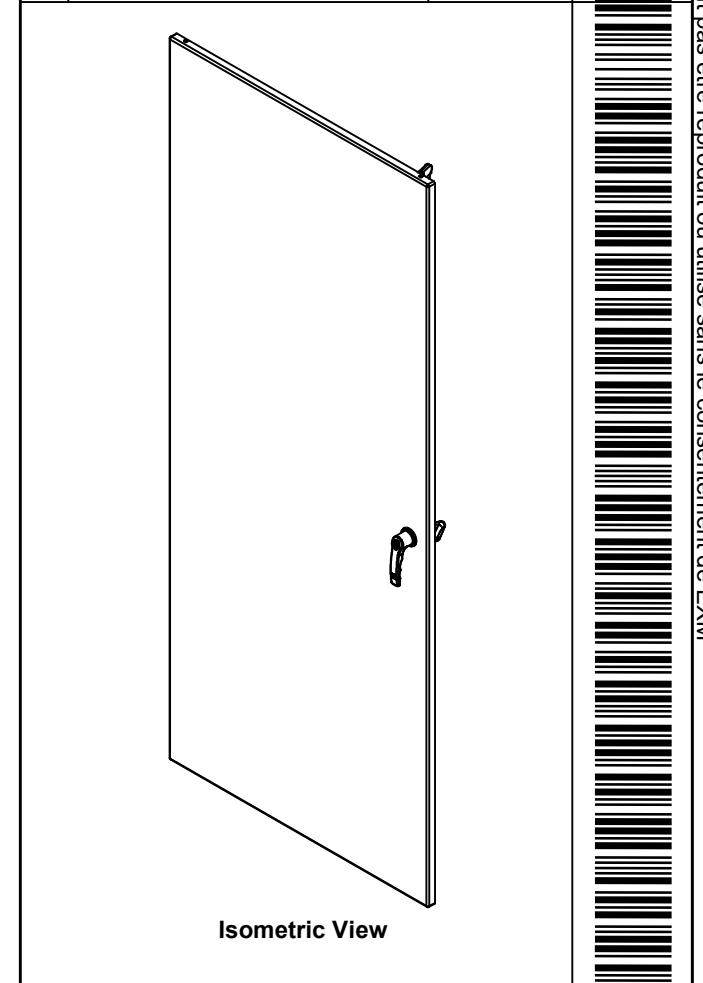

Isometric View



Tél: (450) 979-4373
Fax: (450) 979-4626
www.exmweb.com

Flatness
Aplatissement
Max 3.0mm
Projection

Customer Client	Date
Drawn By Dessiné Par BoxCad: BoxCad	Date 14-Apr-23
Material Matière 14 Ga Cold Rolled A1008 CS Type B (1.7mm)	

Color Couleur Asa-61 Grey	Finish Fini Smooth
------------------------------	-----------------------

Description 5412ESBU 72" x 30" Cover	Detail Rev.
---	-------------

Part Number Numéro Pièce	Rev. 8
-----------------------------	--------

SEE BILL OF MATERIAL ON LAST PAGE 5412ESBU723012THNOIPC 0 16

This drawing is confidential and must not be reproduced or used without the consent of EXM

Ce dessin est confidentiel et ne doit pas être reproduit ou utilisé sans le consentement de EXM

STANDARD FEATURES ARE NOT LISTED IN THIS HOLE TABLE

HOLE TABLE - FRONT VIEW (CUSTOM FEATURE ONLY)

CUT-OUT	XDIM	YDIM	DESCRIPTION
1	1.486	1.945	STUD M6 x 18mm (Inside)
2	1.486	69.858	STUD M6 x 18mm (Inside)
3	25.923	69.858	STUD M6 x 18mm (Inside)
4	25.923	1.945	STUD M6 x 18mm (Inside)
5	1.486	35.902	STUD M6 x 18mm (Inside)
6	25.923	35.902	STUD M6 x 18mm (Inside)
7	1.893	2.350	STUD M6 x 18mm (Inside)
8	1.893	69.524	STUD M6 x 18mm (Inside)
9	25.516	69.524	STUD M6 x 18mm (Inside)
10	25.516	2.350	STUD M6 x 18mm (Inside)
11	27.663	66.896	CLOSING BAR STUD (Inside)
12	27.663	4.907	CLOSING BAR STUD (Inside)
13	14.889	1.435	STUD M6 x 18mm (Inside)
-----	-----	-----	-----
14	27.663	35.902	885 ESL2A

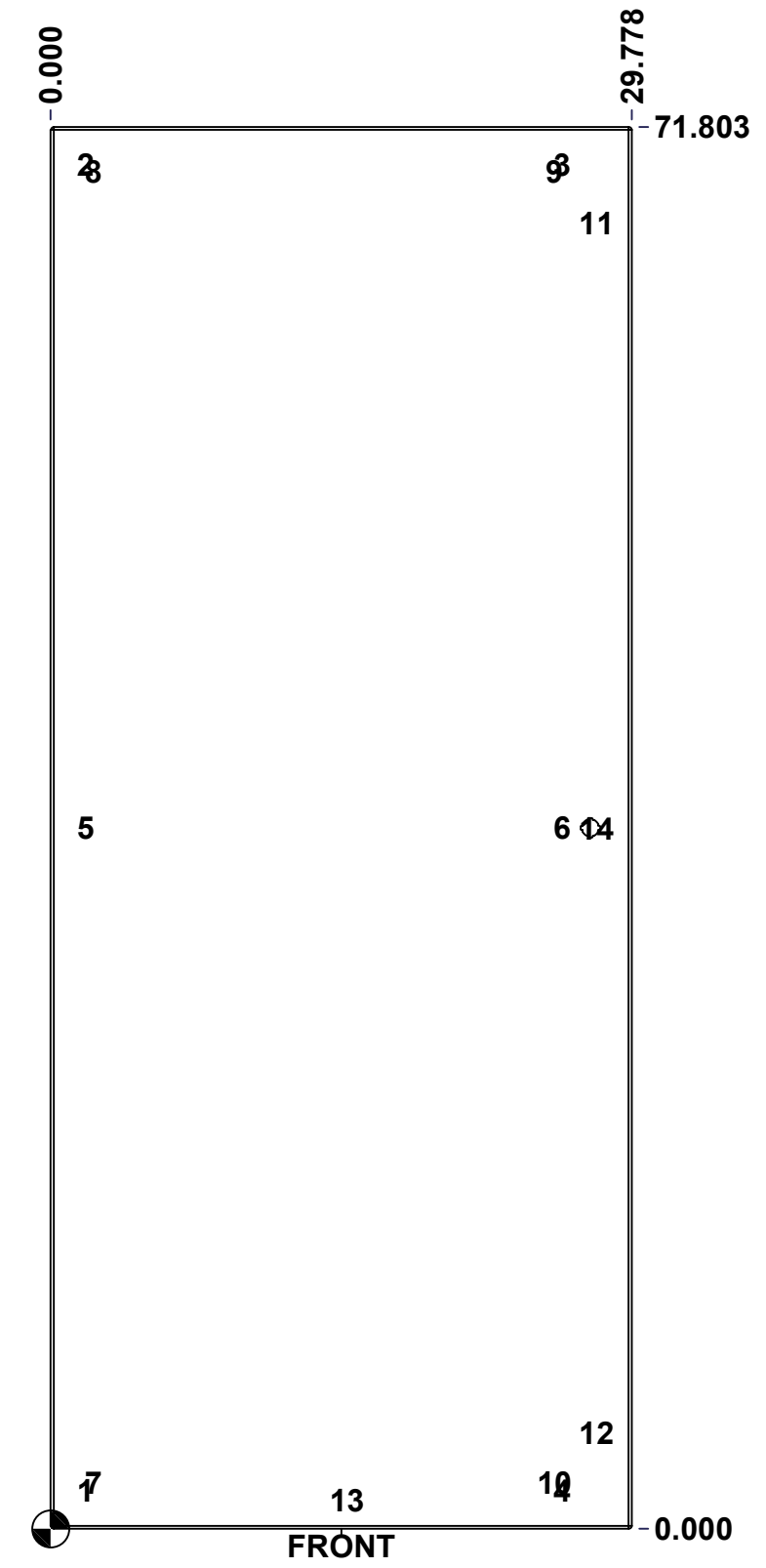

	Description	Status
	5412ESBU 72" x 30" Cover	(NULL)
Part Number Numéro Pièce 5412ESBU723012THNOIPC	Rev.	9
	0	16

This drawing is confidential and must not be reproduced or used without the consent of EXM

Ce dessin est confidentiel et ne doit pas être reproduit ou utilisé sans le consentement de EXM

No.	Revisions	Date	By/Par

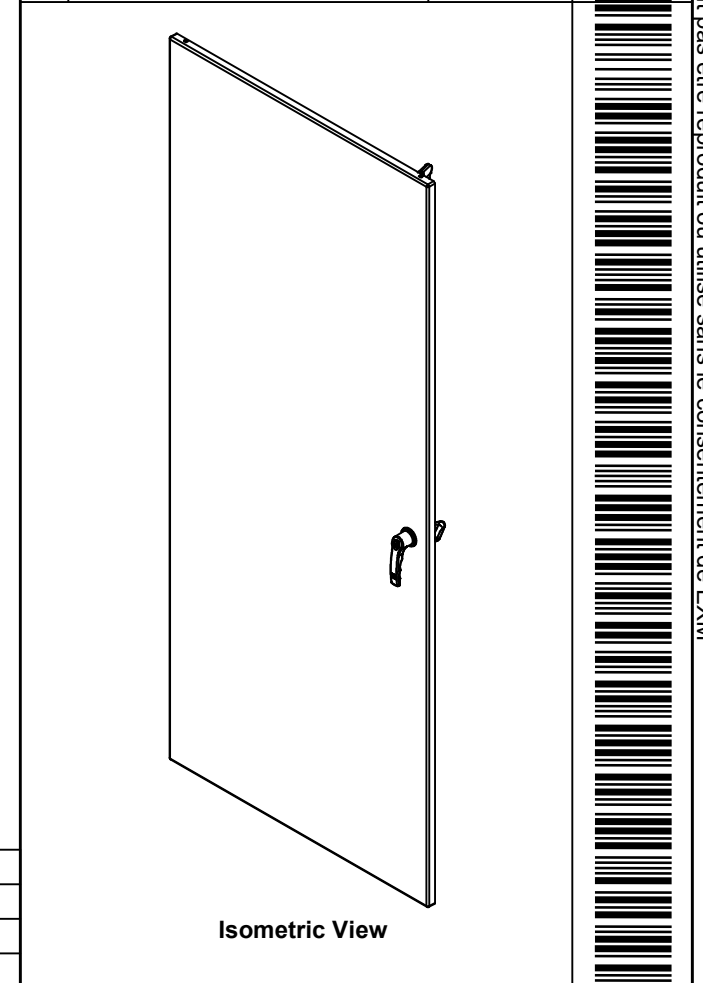

2	STK-Q-90042	4	5412 ES - Cabinet Closing Bar End (Small)
2	STK-Q-45655-72	0	5412 ES - Closing Bar
1	STK-Q-50536	13	5412 ES - Handle Cam Clockwise (Grip 32mm)
1	STK-Q-90051	3	5412 ES - Handle Cam Spacer
1	885 ESL2A	4	5412 ES Key Lock L-Handle (3 Pts)
2	STK-S-00100	0	3.5" x 2" Silver Milar Flexcon Sticker
10	STK-Q-07250	2	M6 x 16mm Collar Nut
2	STK-Q-46020-24	5	5412 ES Vertical Door Stiffener 24"
2	STK-Q-46020-72	5	5412 ES Vertical Door Stiffener 72"
1	5412ESBU723012THNOI PI-C	0	5412ESBU 72" x 30" Cover Insulation
1	STK-P-02400S	0	Powder Paint (Asa-61 Grey / Smooth)
1	STK-Q-46515	3	5412 ES Door Support with Brass Insert
2	STK-Q-16405	6	Guide Stud - Small (No Paint Cap Required)
11	STK-Q-16055	1	M6 x 18mm Stud (No Paint Cap Required)
4	STK-A-33005	4	5412 ESBU Hinge 180° (Body Part)
1	5412ESBU723012THNOI PG	0	5412ESBU 72" x 30" Cover Gasket Part
1	5412ESBU723012THNOI PC-P	0	5412ESBU 72" x 30" Cover Part

QTY	Part Number	Rev	Description
Parts List			



Tél: (450) 979-4373
Fax: (450) 979-4626
www.exmweb.com

Flatness
Aplatissement
Max 3.0mm

Projection

Customer Client

Date

Drawn By
Dessiné Par BoxCad: BoxCad

Date 14-Apr-23

Material
Matière 14 Ga Cold Rolled A1008 CS Type B (1.7mm)

Color
Couleur Asa-61 Grey

Finish
Fini Smooth

Description
5412ESBU 72" x 30" Cover

Detail Rev.

Part Number
Numéro Pièce **5412ESBU723012THNOIPC**

Rev. **0**

This drawing is confidential and must not be reproduced or used without the consent of EXM

Ce dessin est confidentiel et ne doit pas être reproduit ou utilisé sans le consentement de EXM

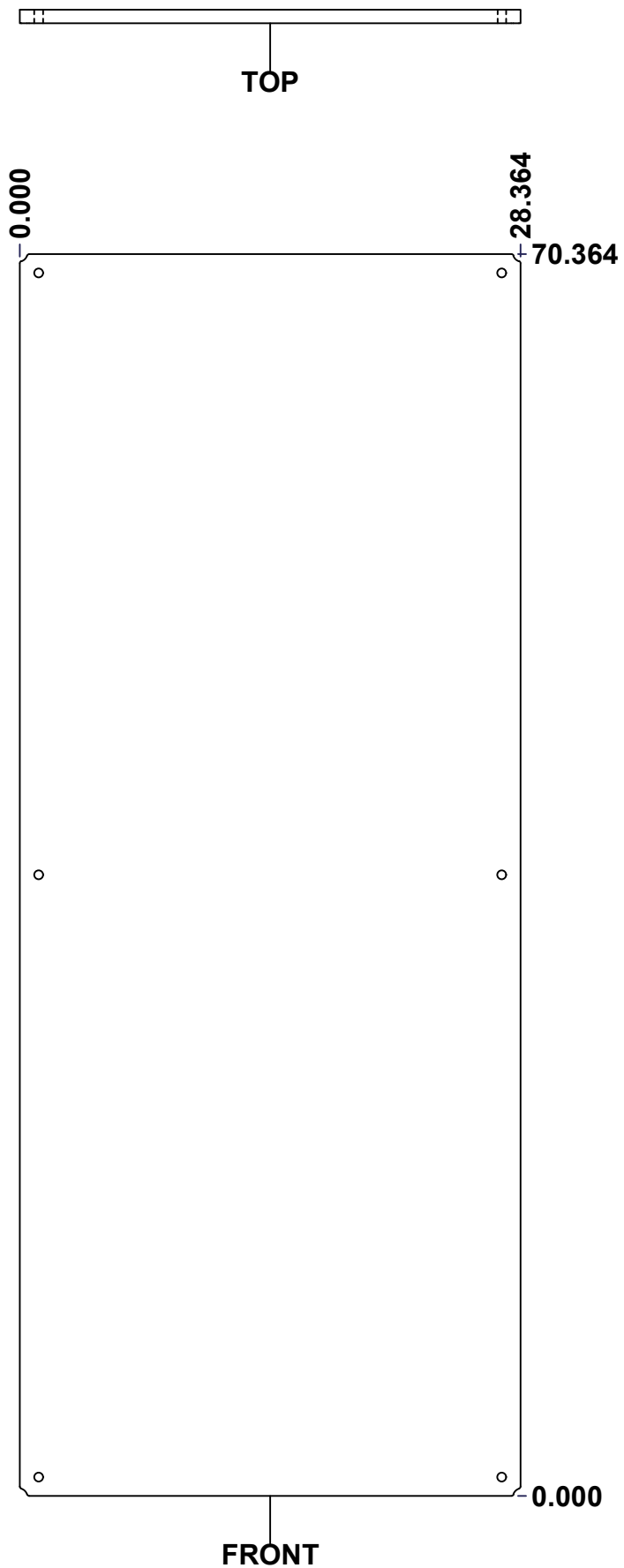

No.	Revisions	Date	By/Par

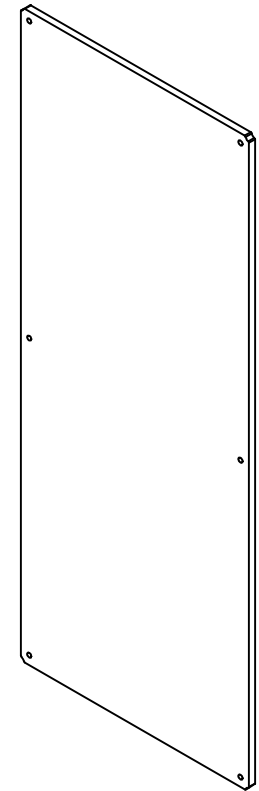

Isometric View

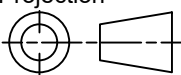

 Tél: (450) 979-4373 Fax: (450) 979-4626 www.exmweb.com	Flatness Aplatissement Max 3.0mm
	Projection 
Customer Client	Date
Drawn By Dessiné Par BoxCad: Patrick Deschenes	Date 23-Jan-07
Material Matière Polyisocyanurate	
Color Couleur Aluminum	Finish Fini N/A
Description 5412ESBU 72" x 30" Back Insulation	Detail Rev.
Part Number Numéro Pièce 5412ESBU723012THNOIPI-B	Rev. 11

SEE BILL OF MATERIAL ON LAST PAGE 0

This drawing is confidential and must not be reproduced or used without the consent of EXM

Ce dessin est confidentiel et ne doit pas être reproduit ou utilisé sans le consentement de EXM

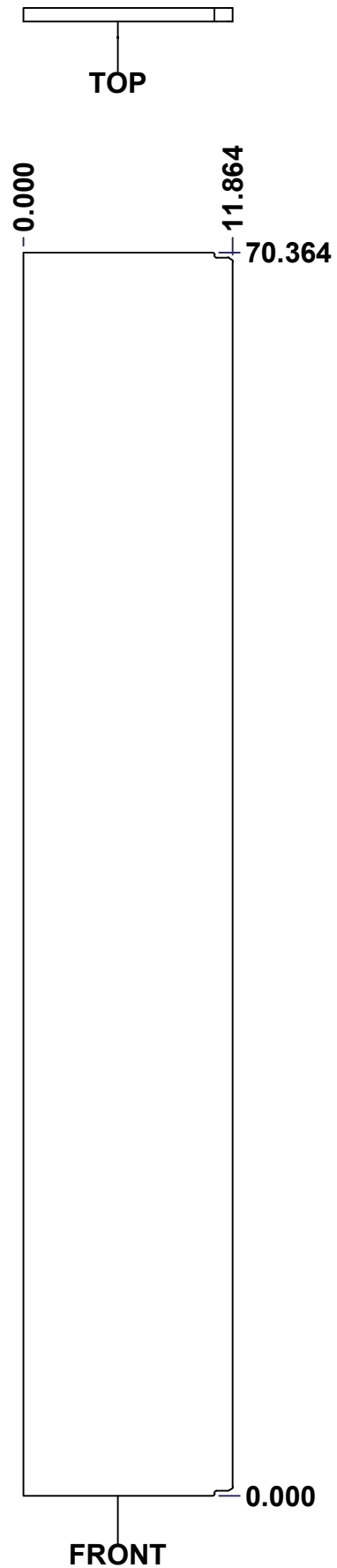

No.	Revisions	Date	By/Par

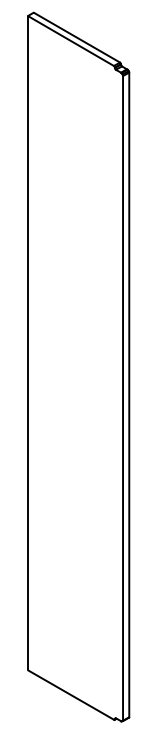

Isometric View

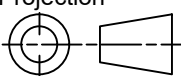

 Tél: (450) 979-4373 Fax: (450) 979-4626 www.exmweb.com		Flatness Aplatissement Max 3.0mm
Projection 		Date 23-Jan-07
Customer Client	Date	
Drawn By Dessiné Par	BoxCad: Patrick Deschenes	Date 23-Jan-07
Material Matière	Polyisocyanurate	
Color Couleur	Aluminum	Finish Fini N/A
Description	Detail Rev.	
5412ESBU 72" x 30" Left Insulation		
Part Number Numéro Pièce	Rev.	12
SEE BILL OF MATERIAL ON LAST PAGE 5412ESBU723012THNOIPI-LS 0		16

This drawing is confidential and must not be reproduced or used without the consent of EXM

Ce dessin est confidentiel et ne doit pas être reproduit ou utilisé sans le consentement de EXM

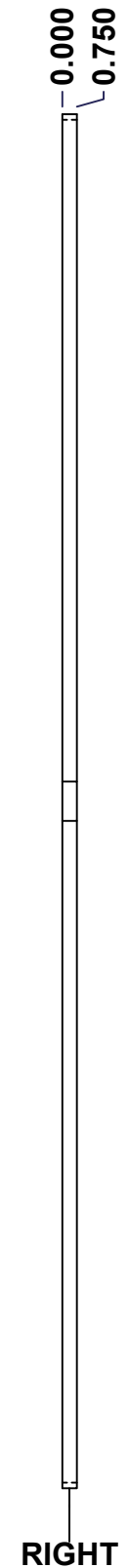
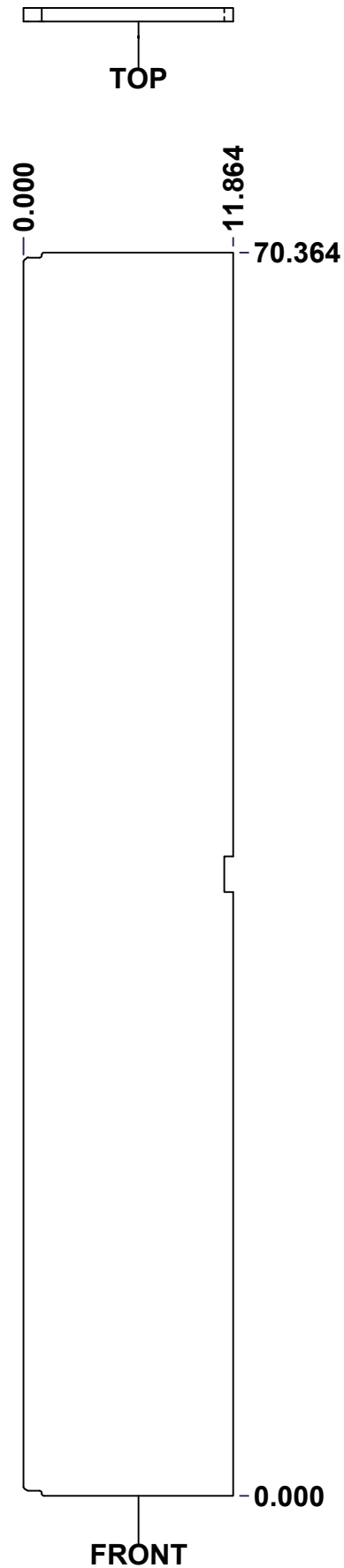

No.	Revisions	Date	By/Par

Isometric View

<p>Tél: (450) 979-4373 Fax: (450) 979-4626 www.exmweb.com</p>		Flatness Aplatissement Max 3.0mm
Customer Client		Projection
Drawn By / Dessiné Par: BoxCad: Patrick Deschenes		Date: 23-Jan-07
Material / Matière: Polyisocyanurate		
Color / Couleur: Aluminum	Finish / Fini: N/A	
Description: 5412ESBU 72" x 30" Right Insulation		Detail Rev.
Part Number / Numéro Pièce: 5412ESBU723012THNOIPI-RS		Rev. 13

SEE BILL OF MATERIAL ON LAST PAGE 5412ESBU723012THNOIPI-RS 0

This drawing is confidential and must not be reproduced or used without the consent of EXM

Ce dessin est confidentiel et ne doit pas être reproduit ou utilisé sans le consentement de EXM

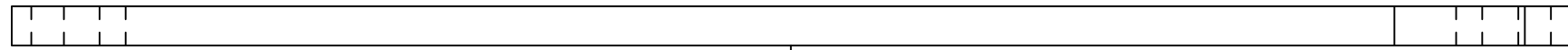

TOP

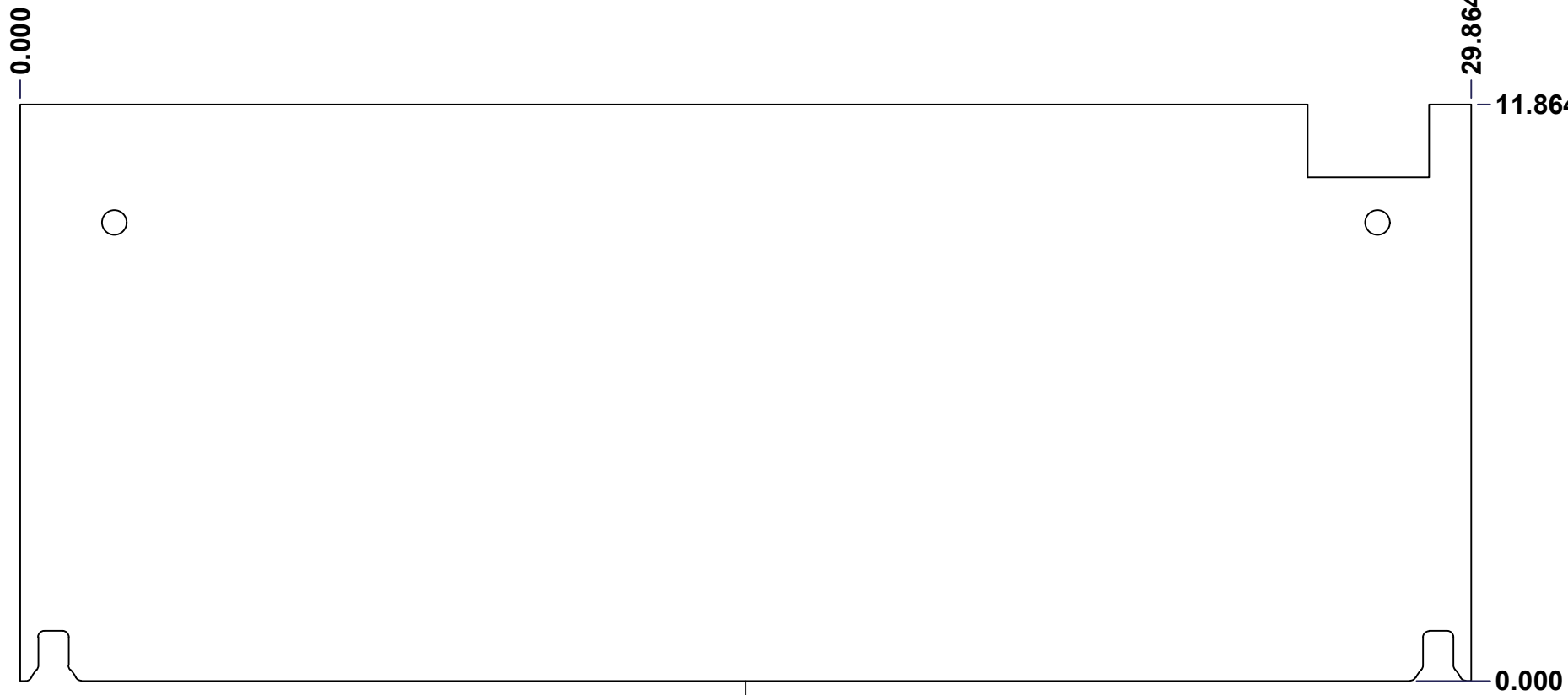

FRONT

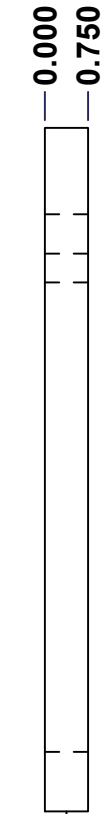

RIGHT

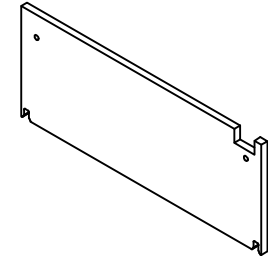

Isometric View

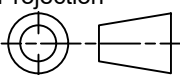

No.	Revisions	Date	By/Par

 Tél: (450) 979-4373 Fax: (450) 979-4626 www.exmweb.com		Flatness Aplatissement Max 3.0mm Projection 
Customer Client	Date	
Drawn By Dessiné Par	BoxCad: Patrick Deschenes	Date 23-Jan-07
Material Matière	Polyisocyanurate	
Color Couleur	Aluminum	Finish Fini N/A
Description	Detail Rev.	
5412ESBU 72" x 30" Top and Bottom Insulation		
Part Number Numéro Pièce	Rev.	14
		16

SEE BILL OF MATERIAL ON LAST PAGE 5412ESBU723012THNOIPI-TP 0

This drawing is confidential and must not be reproduced or used without the consent of EXM

Ce dessin est confidentiel et ne doit pas être reproduit ou utilisé sans le consentement de EXM

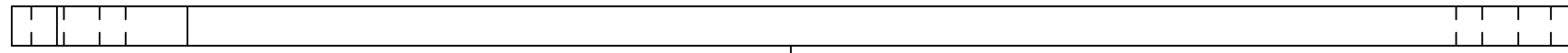

TOP



FRONT

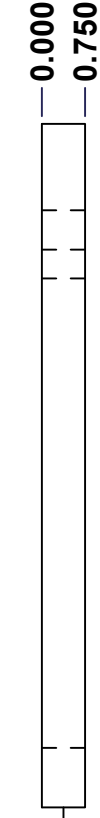

RIGHT

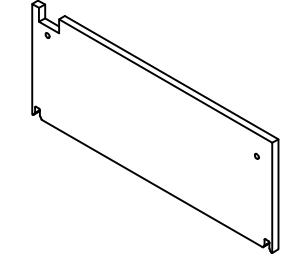

Isometric View

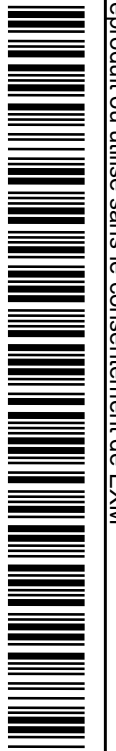

No.	Revisions	Date	By/Par

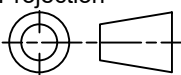
 Tél: (450) 979-4373 Fax: (450) 979-4626 www.exmweb.com		Flatness Aplatissement Max 3.0mm Projection 
Customer Client	Date	
Drawn By Dessiné Par	BoxCad: Patrick Deschenes	Date 23-Jan-07
Material Matière	Polyisocyanurate	
Color Couleur	Aluminum	Finish Fini N/A
Description	Detail Rev.	
5412ESBU 72" x 30" Top and Bottom Insulation		
Part Number Numéro Pièce	Rev.	15
SEE BILL OF MATERIAL ON LAST PAGE		16

SEE BILL OF MATERIAL ON LAST PAGE 5412ESBU723012THNOIPI-BT 0

This drawing is confidential and must not be reproduced or used without the consent of EXM

Ce dessin est confidentiel et ne doit pas être reproduit ou utilisé sans le consentement de EXM

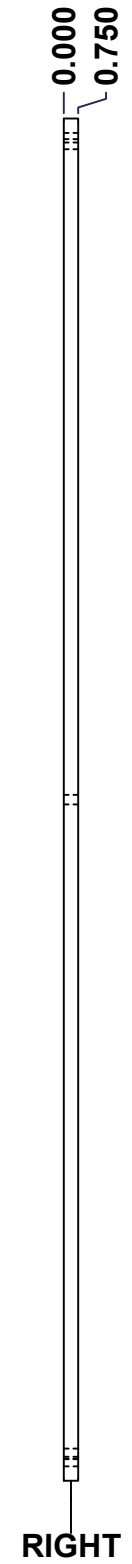
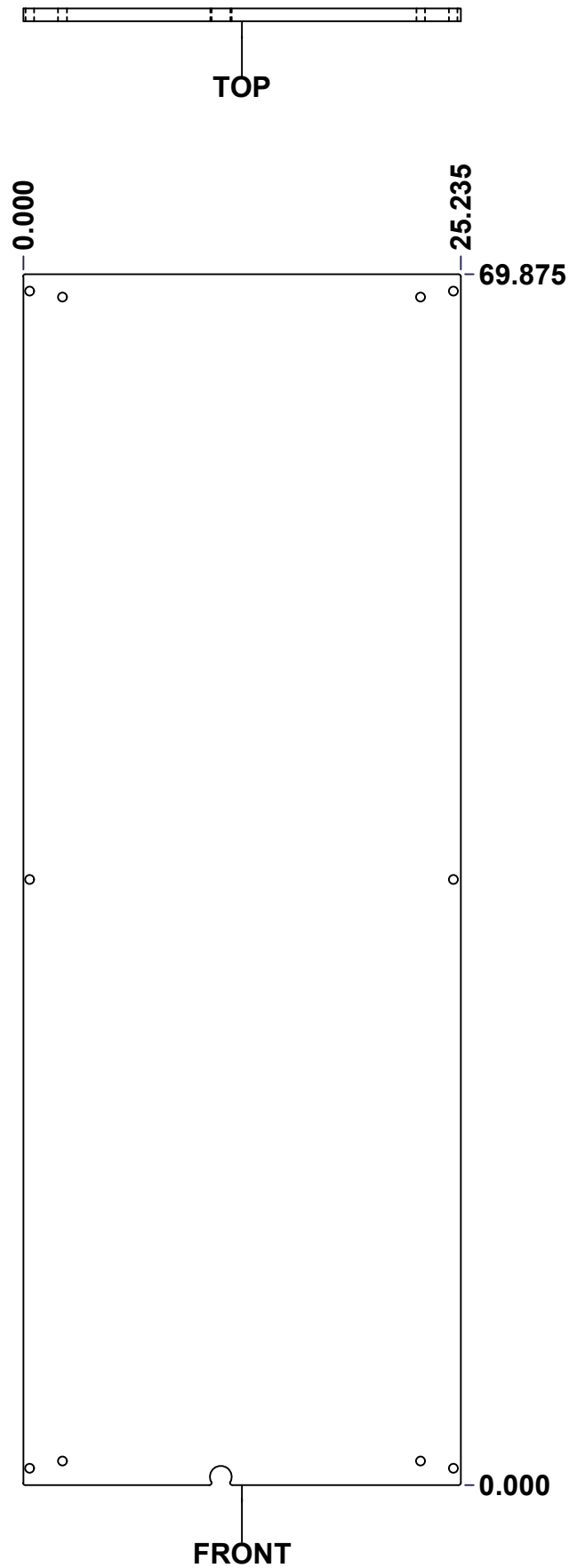

Isometric View

No.	Revisions	Date	By/Par

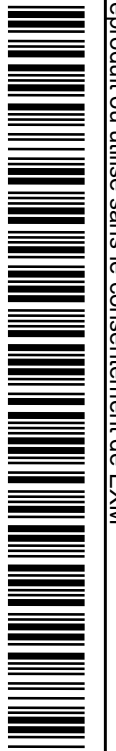

Tél: (450) 979-4373 Fax: (450) 979-4626 www.exmweb.com		Flatness Aplatissement Max 3.0mm
Projection 		Date 23-Jan-07
Customer Client	Date	
Drawn By Dessiné Par	BoxCad: Patrick Deschenes	Date 23-Jan-07
Material Matière	Polyisocyanurate	
Color Couleur	Aluminum	Finish Fini N/A
Description	Detail Rev.	
5412ESBU 72" x 30" Cover Insulation		
Part Number Numéro Pièce	Rev.	16
5412ESBU723012THNOIPI-C	0	16

SEE BILL OF MATERIAL ON LAST PAGE