

This drawing is confidential and must not be reproduced or used without the consent of EXM

Ce dessin est confidentiel et ne doit pas être reproduit ou utilisé sans le consentement de EXM

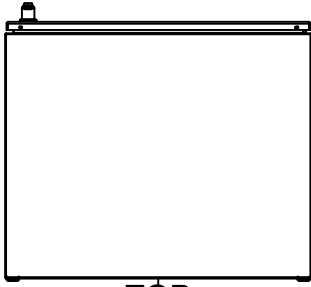

TOP

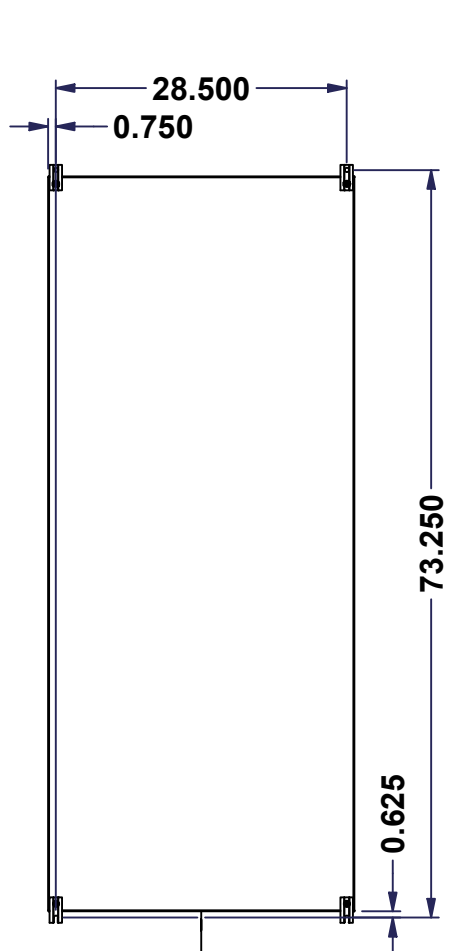

BACK

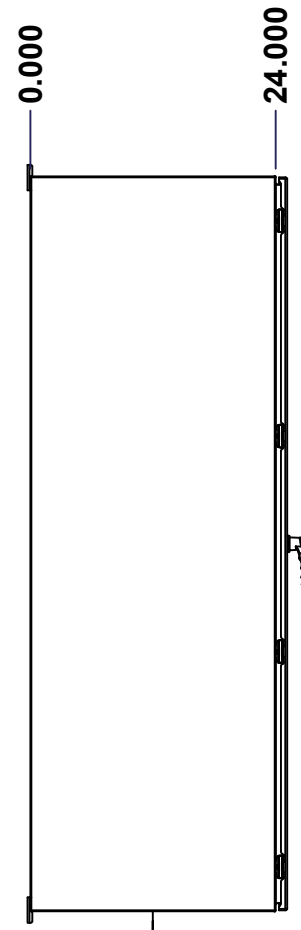

LEFT

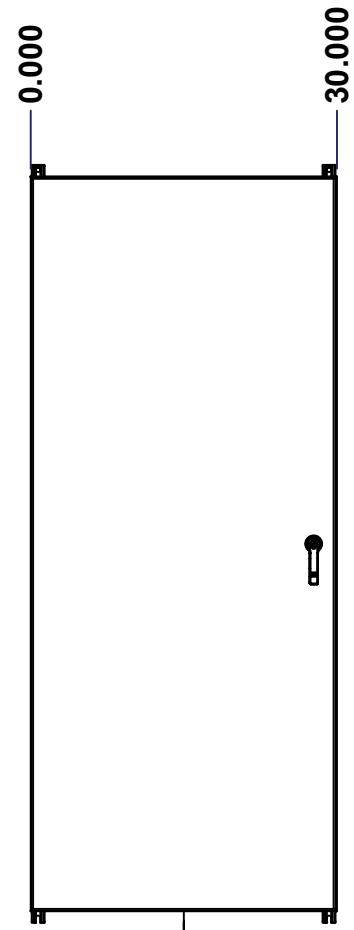

FRONT

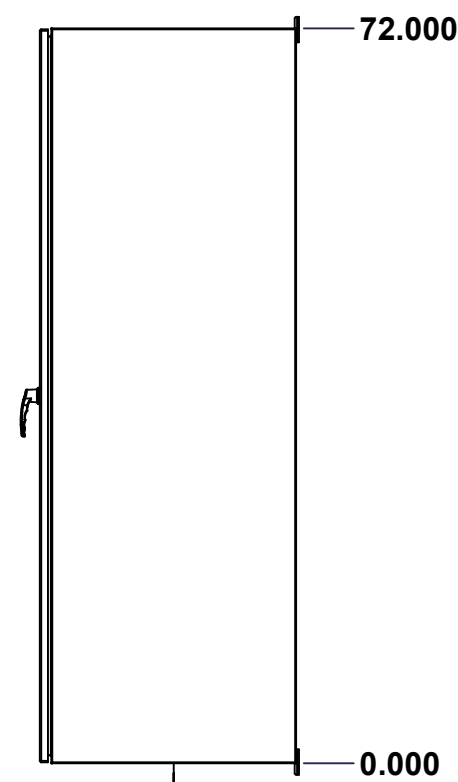

RIGHT

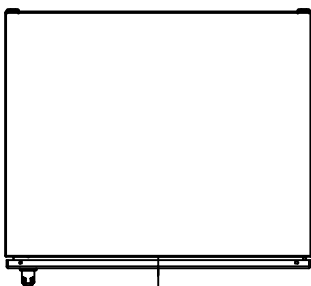

BOTTOM

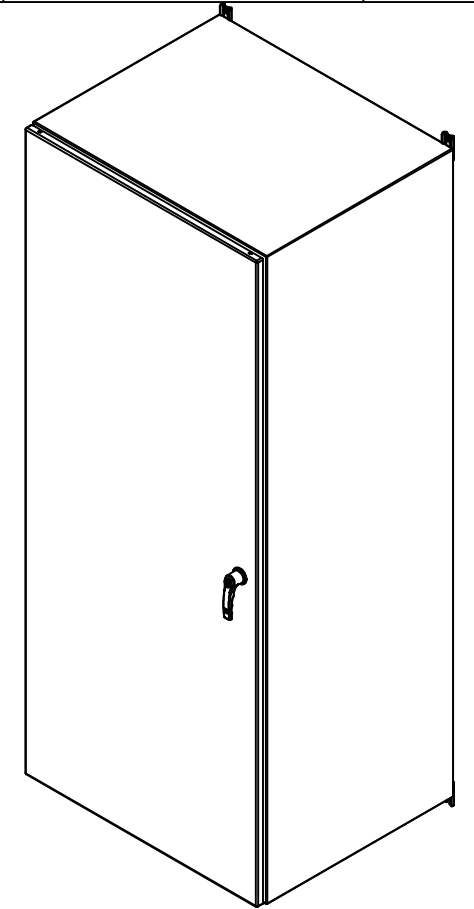

Isometric View



| No. | Revisions | Date | By/Par |
|-----|-----------|------|--------|
| | | | |
| | | | |
| | | | |
| | | | |
| | | | |

| | | |
|--|---|--|
| Tél: (450) 979-4373 Fax: (450) 979-4626 www.exmweb.com | | Flatness Aplatissement Max 3.0mm Projection |
| Customer Client | Date | |
| Drawn By Dessiné Par | BoxCad: BoxCad | Date 14-Apr-23 |
| Material Matière | 14 Ga Cold Rolled A1008 CS Type B (1.7mm) | |
| Color Couleur | Asa-61 Grey | Finish Fini Smooth |
| Description | Detail Rev. | |
| 5412ESBU 72" x 30" x 24" Assembly | | |
| Part Number Numéro Pièce | Rev. 0 | 1 / 16 |

SEE BILL OF MATERIAL ON LAST PAGE **5412ESBU723024THNOIP**

This drawing is confidential and must not be reproduced or used without the consent of EXM

Ce dessin est confidentiel et ne doit pas être reproduit ou utilisé sans le consentement de EXM

| NOTE | |
|------|---|
| ITEM | DESCRIPTION |
| 1 | NEMA 4/12 Enclosure |
| 2 | C/W Standard ground studs on box and cover |
| 3 | C/W Standard door stiffener |
| 4 | W/O Inner panel |
| 5 | C/W Standard inner panel mounting studs |
| 6 | C/W 885 ESMF3_OPEN Sold separately (Installed) |
| 7 | C/W 885 ESMF3_CLOSE Sold separately (Installed) |
| 8 | C/W R5 Insulation (Installed by EXM) |

| No. | Revisions | Date | By/Par |
|-----|-----------|------|--------|
| | | | |
| | | | |
| | | | |
| | | | |
| | | | |
| | | | |
| | | | |

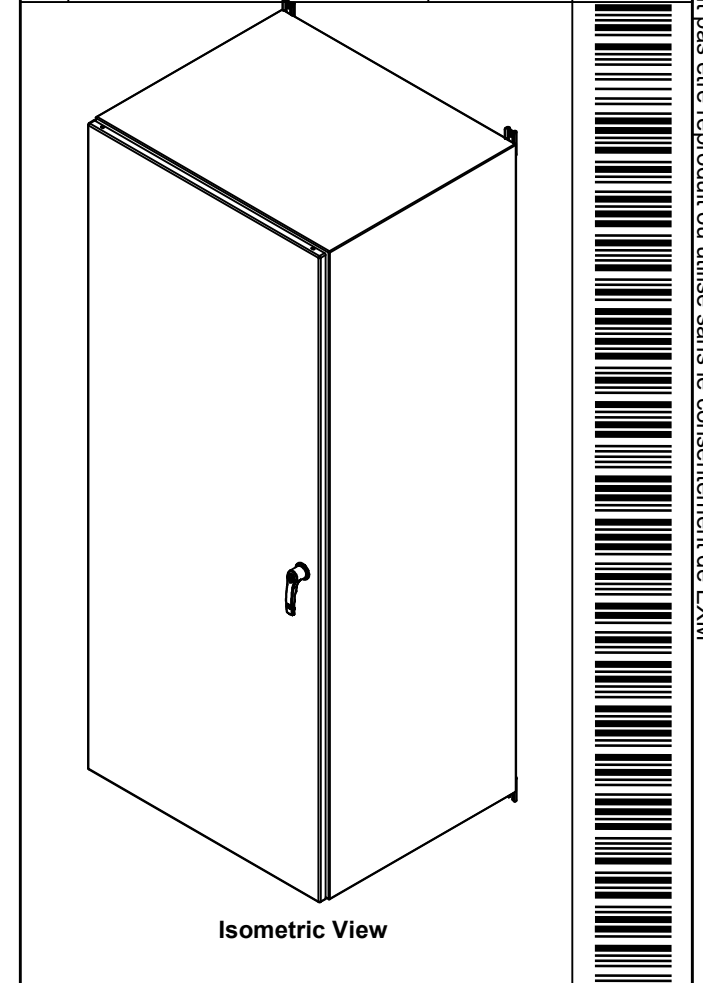

| PACKING | | |
|-----------------------|-----|--|
| ITEM | QTY | DESCRIPTION |
| Cardboard sleeve | 2 | Top and Bottom |
| Cardboard strip | 2 | Between back of enclosure and inner panel |
| Plastic bag | 1 | To protect cover surface and inside gasket |
| Cardboard corner | 4 | To reinforced for the plastic strap tightening |
| Plastic strap - Black | 2 | To Squeeze the 2 cardboard sleeve together |
| Packaging label | 3 | White label with PN |
| Plastic strap- Green | 2 | To secure the enclosure to the wood pallet |
| Wood Pallet | 1 | 2" deeper and 3" larger than enclosure size |

| | | | |
|------------|---------------------------|-----|--|
| 6 | STK-Q-00600 | 2 | M12 to M8 Adaptor |
| 1 | STK-K-01800 | 5 | 5412 ES Accessory Kit |
| 1 | 5412ESBU723024THNOI PC | 0 | 5412ESBU 72" x 30" Cover |
| 1 | 5412ESBU723024THNOI PB | 0 | 5412ESBU 72" x 30" x 24" Body |
| 8 | STK-Q-04050-08 | 0 | M6 x 8mm Hexagon Socket Head Machine Screw |
| Qty | Part Number | Rev | Description |
| Parts List | | | |

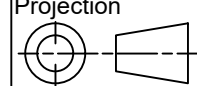
| | | |
|--|---|---|
|  Tél: (450) 979-4373 Fax: (450) 979-4626 www.exmweb.com | | Flatness Aplatissement Max 3.0mm Projection  |
| Customer Client | Date | |
| Drawn By Dessiné Par | BoxCad: BoxCad | Date 14-Apr-23 |
| Material Matière | 14 Ga Cold Rolled A1008 CS Type B (1.7mm) | |
| Color Couleur | Asa-61 Grey | Finish Fini Smooth |
| Description | Detail Rev. | |
| 5412ESBU 72" x 30" x 24" Assembly | | |
| Part Number Numéro Pièce | Rev. | 2 |
| 5412ESBU723024THNOIP | 0 | 16 |

This drawing is confidential and must not be reproduced or used without the consent of EXM

Ce dessin est confidentiel et ne doit pas être reproduit ou utilisé sans le consentement de EXM

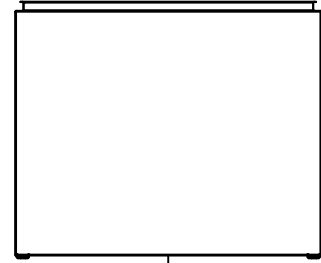

TOP

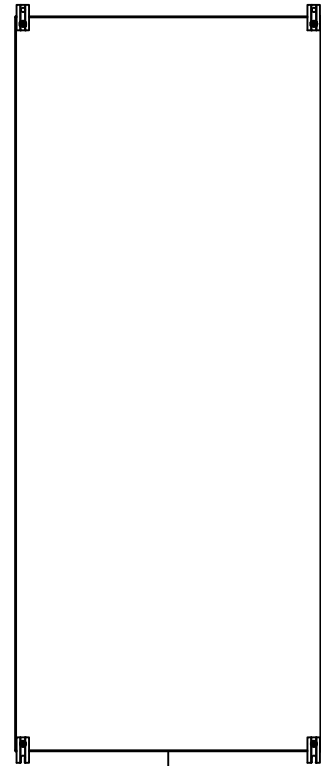

BACK

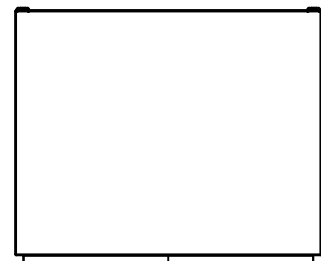

BOTTOM

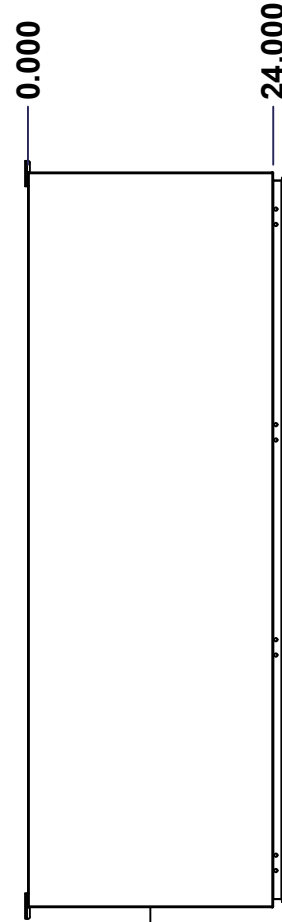

LEFT

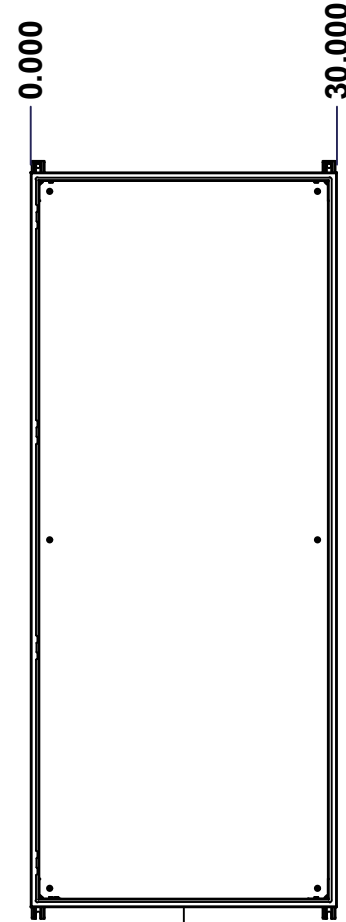

FRONT

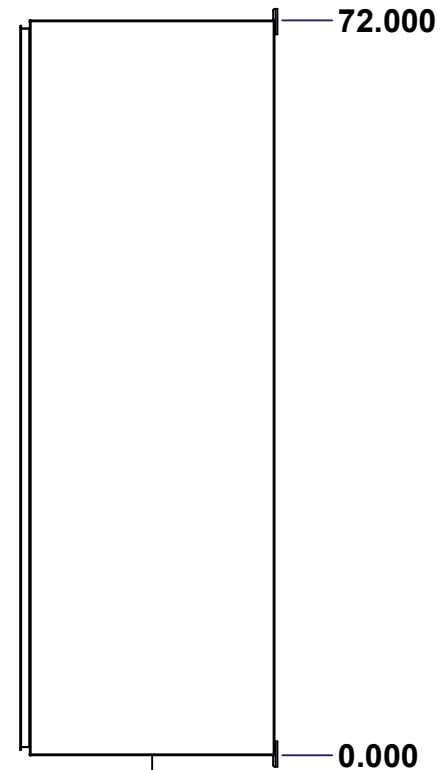

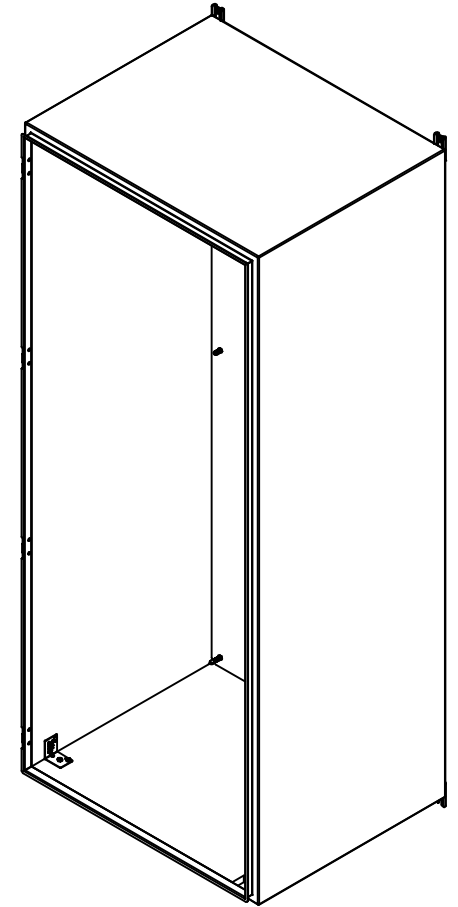

RIGHT



Isometric View

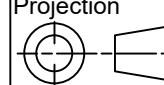

| No. | Revisions | Date | By/Par |
|-----|-----------|------|--------|
| | | | |
| | | | |
| | | | |
| | | | |
| | | | |

| | | |
|--|--|--|
|  Tél: (450) 979-4373 Fax: (450) 979-4626 www.exmweb.com | | Flatness Aplatissement  Max 3.0mm |
| Customer Client Drawn By / Dessiné Par: BoxCad: BoxCad Material / Matière: 14 Ga Cold Rolled A1008 CS Type B (1.7mm) | | Projection  Date: 14-Apr-23 |
| Color / Couleur: Asa-61 Grey Finish / Fini: Smooth | | Detail Rev. |
| Description: 5412ESBU 72" x 30" x 24" Body | | Part Number / Numéro Pièce: 5412ESBU723024THNOIPB |
| Rev. 0 | | 3 / 16 |

SEE BILL OF MATERIAL ON LAST PAGE 5412ESBU723024THNOIPB

This drawing is confidential and must not be reproduced or used without the consent of EXM

Ce dessin est confidentiel et ne doit pas être reproduit ou utilisé sans le consentement de EXM

| STANDARD FEATURES ARE NOT LISTED IN THIS HOLE TABLE | | | |
|---|--------|--------|--------------------------------|
| HOLE TABLE - TOP VIEW (CUSTOM FEATURE ONLY) | | | |
| CUT-OUT | XDIM | YDIM | DESCRIPTION |
| 1 | 2.000 | 21.500 | INSUL. STUD M6 x 18mm (Inside) |
| 2 | 28.000 | 21.500 | INSUL. STUD M6 x 18mm (Inside) |

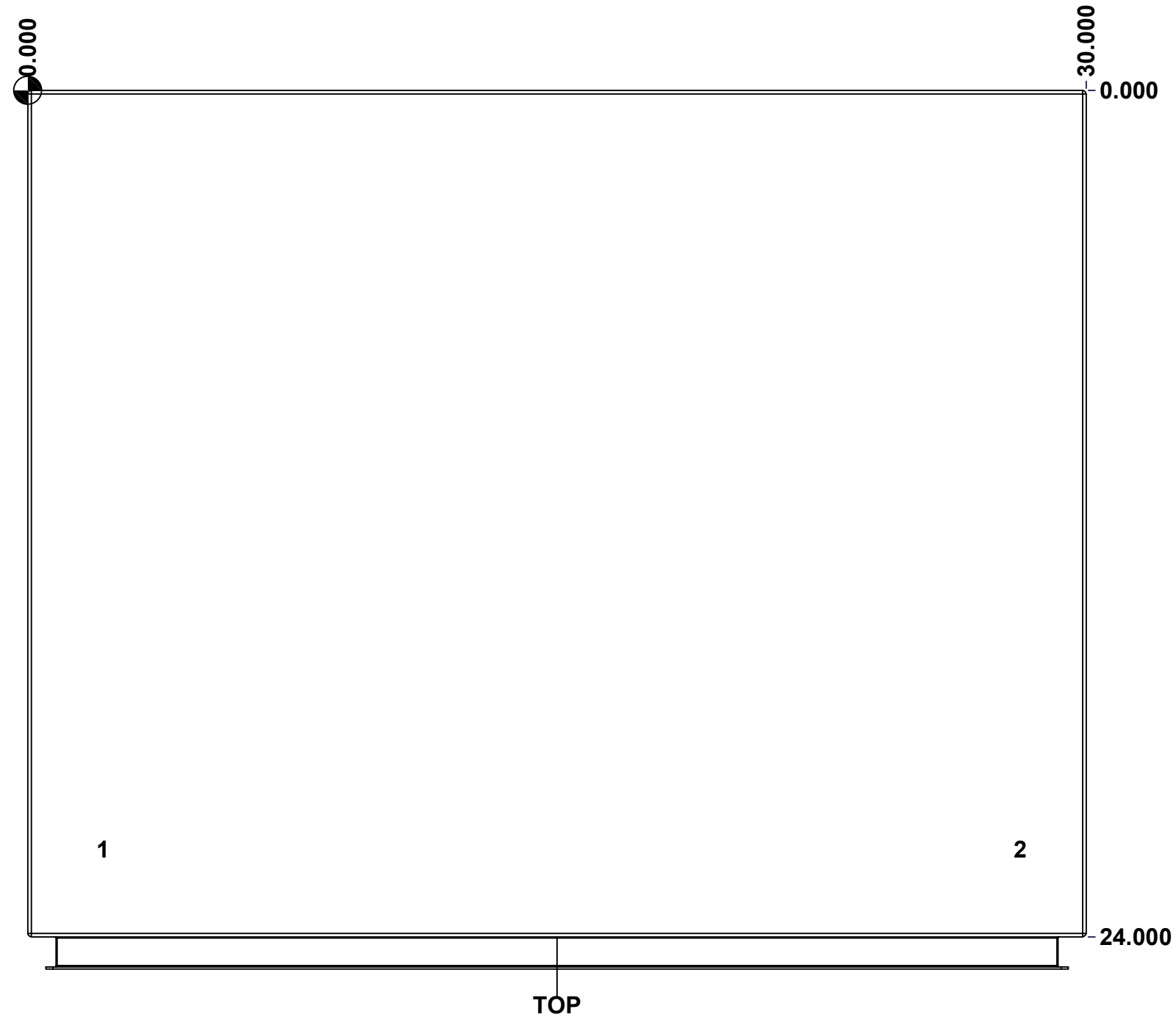

| | | |
|--|-------------------------------|----------|
| | Description | Status |
| | 5412ESBU 72" x 30" x 24" Body | (NULL) |
| | Part Number Numéro Pièce | Rev. |
| | 5412ESBU723024THNOIPB | 0 |
| | | 4 |
| | | 16 |

This drawing is confidential and must not be reproduced or used without the consent of EXM

Ce dessin est confidentiel et ne doit pas être reproduit ou utilisé sans le consentement de EXM

| STANDARD FEATURES ARE NOT LISTED IN THIS HOLE TABLE | | | |
|---|--------|--------|--------------------------------|
| HOLE TABLE - BOTTOM VIEW (CUSTOM FEATURE ONLY) | | | |
| CUT-OUT | XDIM | YDIM | DESCRIPTION |
| 1 | 2.000 | 21.500 | INSUL. STUD M6 x 18mm (Inside) |
| 2 | 28.000 | 21.500 | INSUL. STUD M6 x 18mm (Inside) |

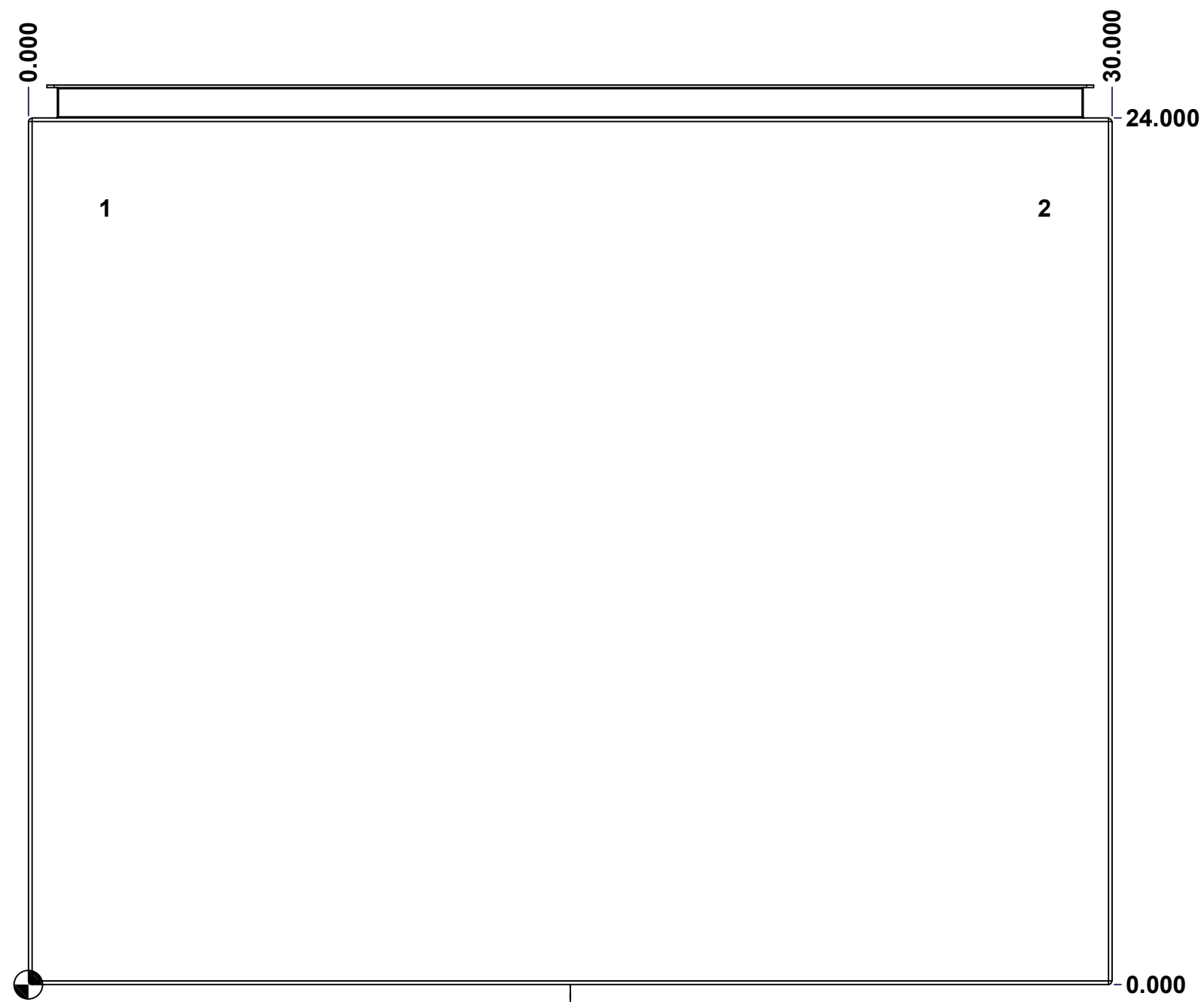

BOTTOM

| | | |
|--|-------------------------------|----------|
| | Description | Status |
| | 5412ESBU 72" x 30" x 24" Body | (NULL) |
| | Part Number Numéro Pièce | Rev. |
| | 5412ESBU723024THNOIPB | 0 |
| | | 5 |
| | | 16 |

This drawing is confidential and must not be reproduced or used without the consent of EXM

Ce dessin est confidentiel et ne doit pas être reproduit ou utilisé sans le consentement de EXM

STANDARD FEATURES ARE NOT LISTED IN THIS HOLE TABLE

HOLE TABLE - BACK VIEW (CUSTOM FEATURE ONLY)

| CUT-OUT | XDIM | YDIM | DESCRIPTION |
|---------|--------|--------|----------------------------|
| 1 | 1.875 | 1.875 | IP STUD M8 x 35mm (Inside) |
| 2 | 1.875 | 70.125 | IP STUD M8 x 35mm (Inside) |
| 3 | 28.125 | 70.125 | IP STUD M8 x 35mm (Inside) |
| 4 | 28.125 | 1.875 | IP STUD M8 x 35mm (Inside) |
| 5 | 1.875 | 36.000 | IP STUD M8 x 35mm (Inside) |
| 6 | 28.125 | 36.000 | IP STUD M8 x 35mm (Inside) |
| ----- | | | |
| 7 | 29.250 | 0.000 | FOOT 885 ESMF3_OPEN |
| 8 | 0.750 | 0.000 | FOOT 885 ESMF3_OPEN |
| 9 | 29.250 | 72.000 | FOOT 885 ESMF3_CLOSE |
| 10 | 0.750 | 72.000 | FOOT 885 ESMF3_CLOSE |

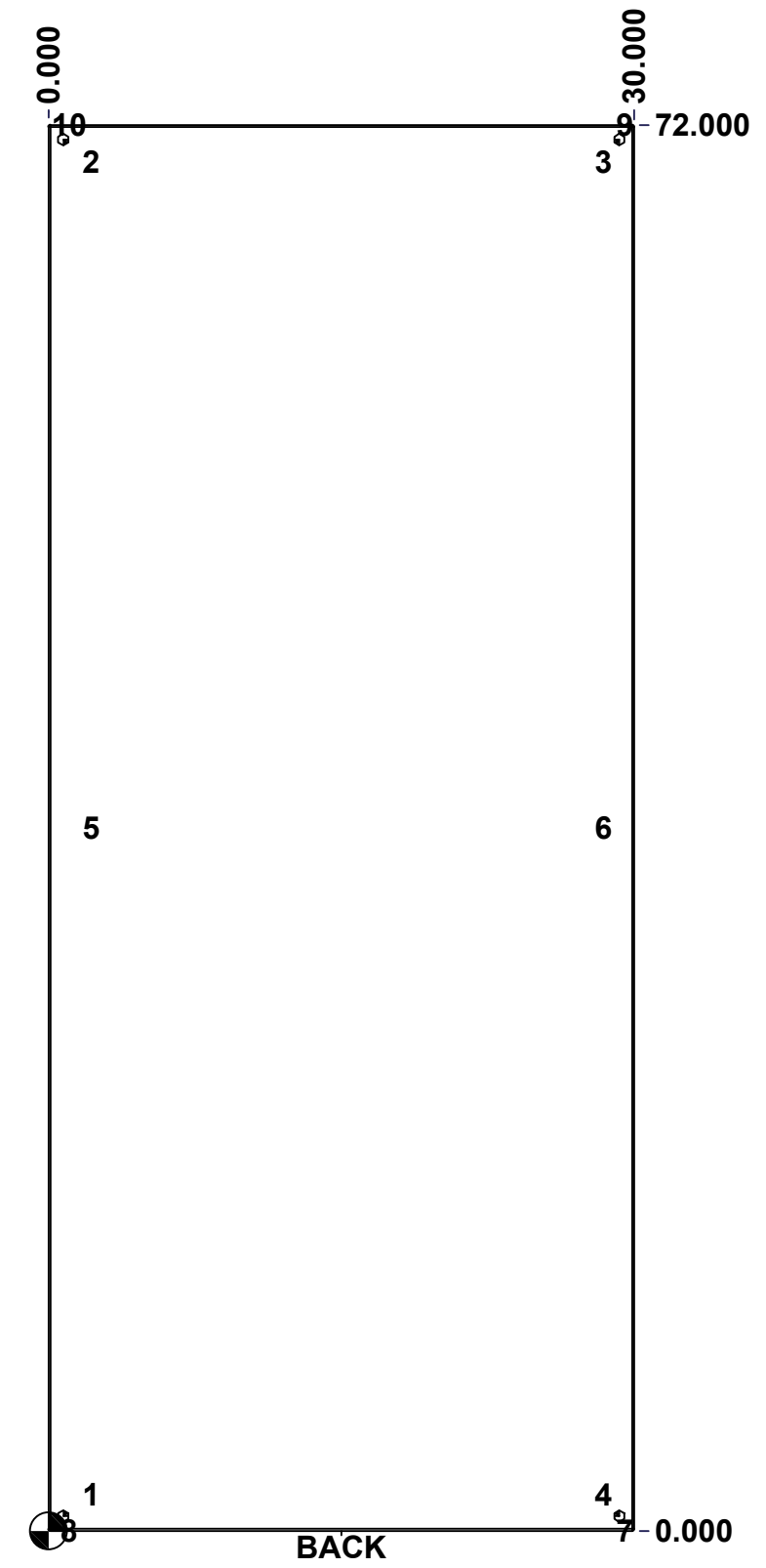

| | | |
|--|-------------------------------|--------------|
| | Description | Status |
| | 5412ESBU 72" x 30" x 24" Body | (NULL) |
| | Part Number Numéro Pièce | Rev. |
| | 5412ESBU723024THNOIPB | 0 / 6 |
| | | 16 |

This drawing is confidential and must not be reproduced or used without the consent of EXM

Ce dessin est confidentiel et ne doit pas être reproduit ou utilisé sans le consentement de EXM

| No. | Revisions | Date | By/Par |
|-----|-----------|------|--------|
| | | | |
| | | | |
| | | | |
| | | | |
| | | | |

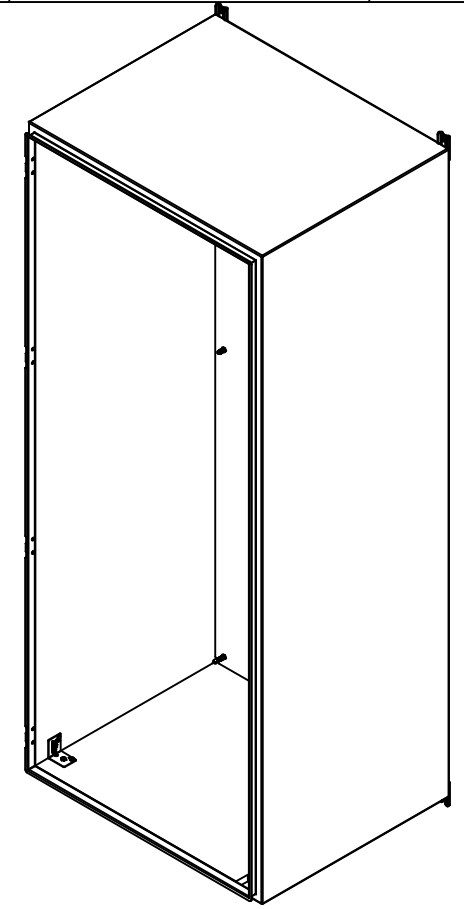

Isometric View

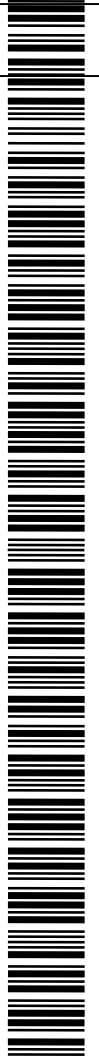

| | | | |
|---|------------------------------|---|--|
| 2 | 885ESMF3-FEET | 0 | 885 ESMF3 Mounting Foot |
| 4 | RIVET_NUT_M10_FH_CE | 0 | Rivet Nut M10 (Low Profile Close End) |
| 4 | STK-Q-06660 | 2 | M10 x 16mm Machine Screw |
| 2 | 885ESMF3-FEET-A | 0 | 885 ESMF3 Mounting Foot (Opened Slot) |
| 1 | STK-K-70554 | 3 | 5412 ESTH Accessory Kit |
| 1 | 5412ESBU723024THNOI PI-RS | 0 | 5412ESBU 72" x 30" Right Insulation |
| 1 | 5412ESBU723024THNOI PI-LS | 0 | 5412ESBU 72" x 30" Left Insulation |
| 1 | 5412ESBU723024THNOI PI-BT | 0 | 5412ESBU 72" x 30" Top and Bottom Insulation |
| 1 | 5412ESBU723024THNOI PI-TP | 0 | 5412ESBU 72" x 30" Top and Bottom Insulation |
| 1 | 5412ESBU723024THNOI PI-B | 0 | 5412ESBU 72" x 30" Back Insulation |
| 4 | STK-Q-16055 | 1 | M6 x 18mm Stud (No Paint Cap Required) |
| 1 | STK-P-02400S | 0 | Powder Paint (Asa-61 Grey / Smooth) |
| 6 | STK-Q-16005 | 1 | Stud M8 x 35 (No Paint Cap Required) |
| 1 | 5412ESBU723024THNOI PB-P | 0 | 5412ESBU 72" x 30" x 24" Body Part |

| Qty | Part Number | Rev | Description |
|------------|-------------|-----|-------------|
| Parts List | | | |

| | | | |
|--|--|--|--------|
| | Tél: (450) 979-4373 Fax: (450) 979-4626 www.exmweb.com | Flatness Aplatissement Max 3.0mm | |
| | Projection | Customer Client | Date |
| Drawn By Dessiné Par | BoxCad: BoxCad | Date 14-Apr-23 | |
| Material Matière | 14 Ga Cold Rolled A1008 CS Type B (1.7mm) | | |
| Color Couleur | Asa-61 Grey | Finish Fini | Smooth |
| Description 5412ESBU 72" x 30" x 24" Body | | Detail Rev. | |
| Part Number Numéro Pièce | | Rev. | 7 |
| 5412ESBU723024THNOIPB | | 0 | 16 |

This drawing is confidential and must not be reproduced or used without the consent of EXM

Ce dessin est confidentiel et ne doit pas être reproduit ou utilisé sans le consentement de EXM

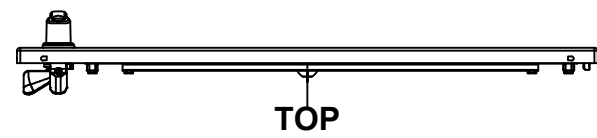

TOP

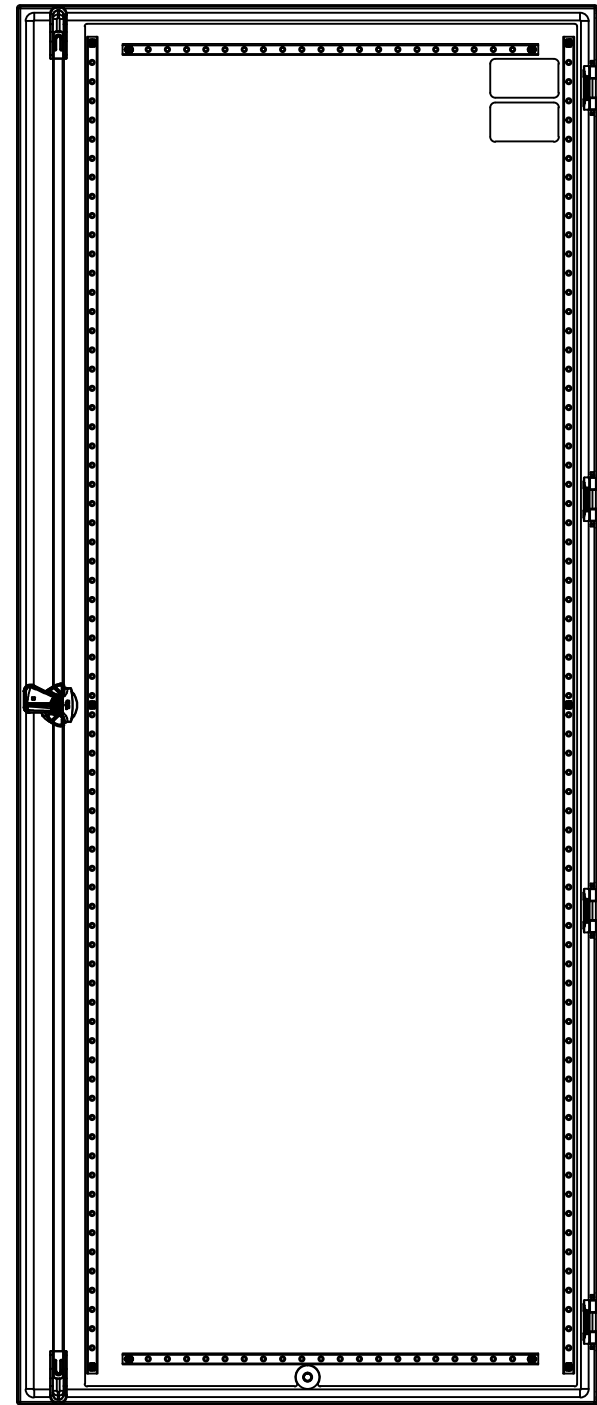

BACK

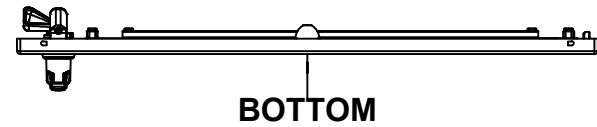

BOTTOM

0.000
0.800

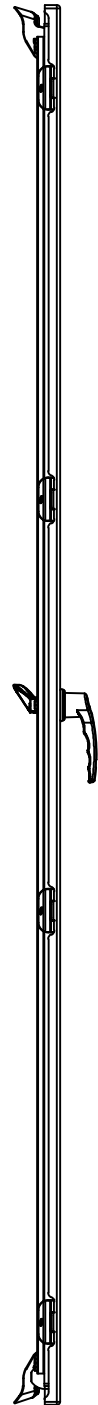

LEFT

0.000

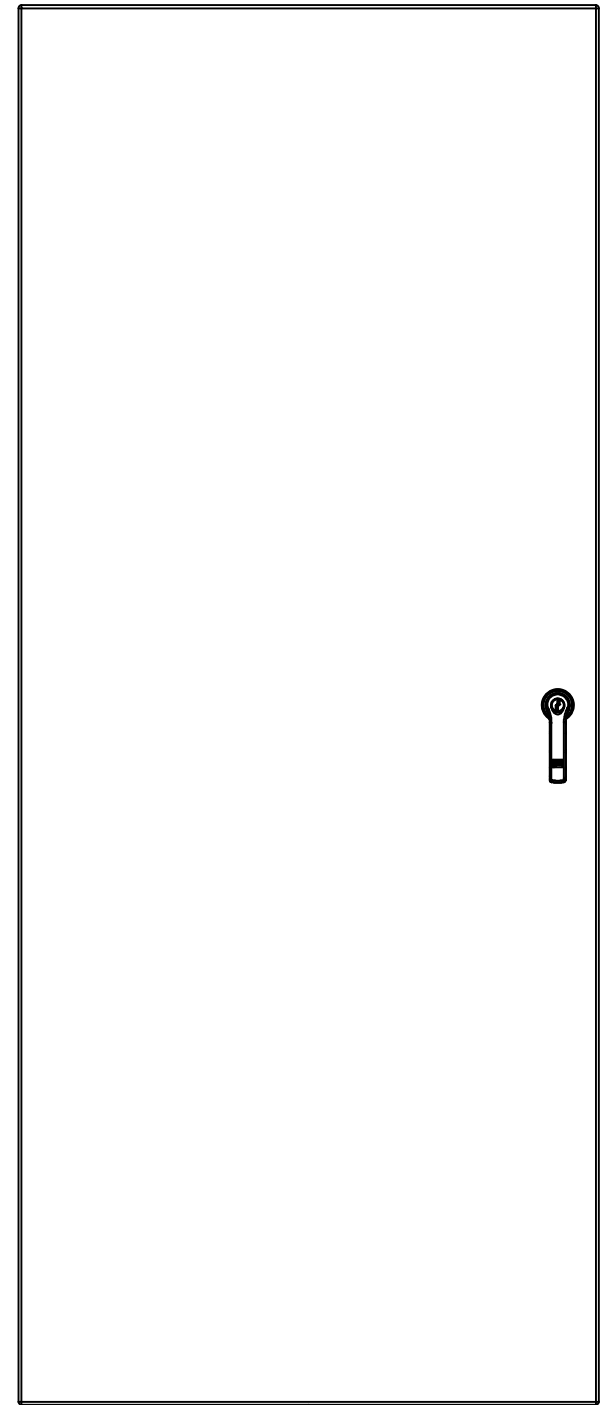

FRONT

29.778

71.803

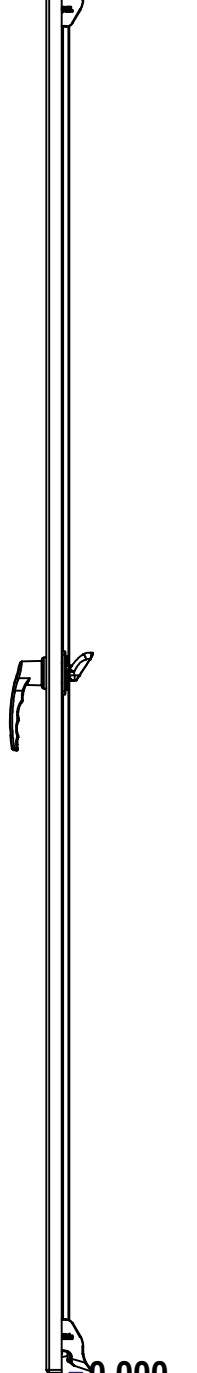

RIGHT

0.000

| No. | Revisions | Date | By/Par |
|-----|-----------|------|--------|
| | | | |
| | | | |
| | | | |
| | | | |
| | | | |

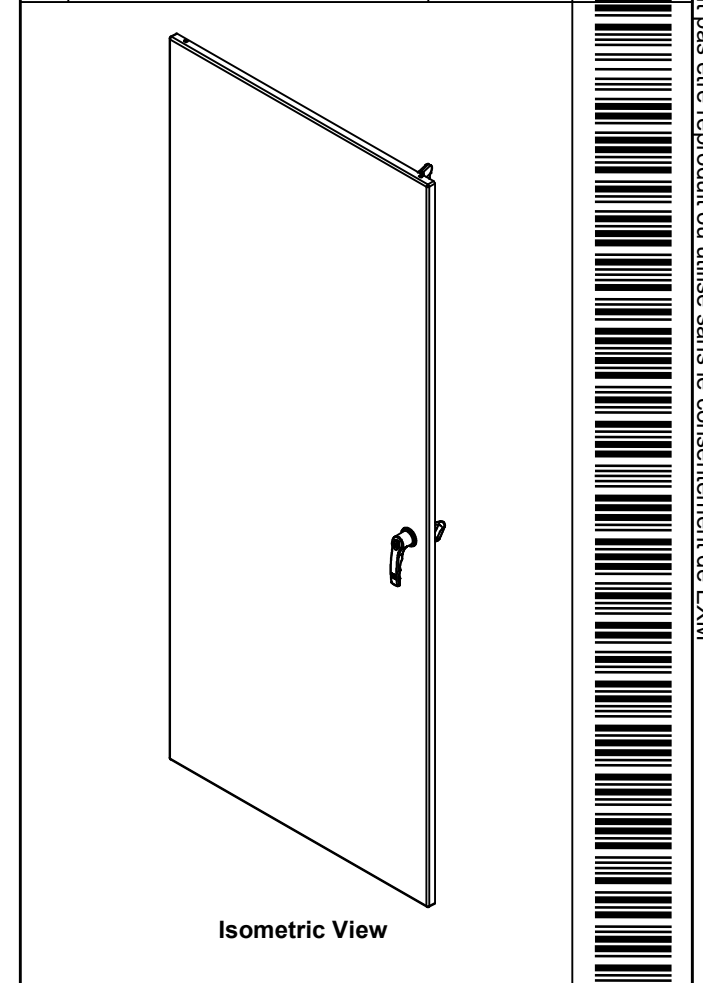

Isometric View



Tél: (450) 979-4373
Fax: (450) 979-4626
www.exmweb.com

Flatness
Aplatissement
Max 3.0mm
Projection

| | |
|---|----------------|
| Customer Client | Date |
| Drawn By Dessiné Par BoxCad: BoxCad | Date 14-Apr-23 |
| Material Matière 14 Ga Cold Rolled A1008 CS Type B (1.7mm) | |

| | |
|------------------------------|-----------------------|
| Color Couleur Asa-61 Grey | Finish Fini Smooth |
|------------------------------|-----------------------|

| | |
|---|-------------|
| Description 5412ESBU 72" x 30" Cover | Detail Rev. |
|---|-------------|

| | |
|-----------------------------|--------|
| Part Number Numéro Pièce | Rev. 8 |
|-----------------------------|--------|

SEE BILL OF MATERIAL ON LAST PAGE 5412ESBU723024THNOIPC 0 16

This drawing is confidential and must not be reproduced or used without the consent of EXM

Ce dessin est confidentiel et ne doit pas être reproduit ou utilisé sans le consentement de EXM

STANDARD FEATURES ARE NOT LISTED IN THIS HOLE TABLE

HOLE TABLE - FRONT VIEW (CUSTOM FEATURE ONLY)

| CUT-OUT | XDIM | YDIM | DESCRIPTION |
|---------|--------|--------|---------------------------|
| 1 | 1.486 | 1.945 | STUD M6 x 18mm (Inside) |
| 2 | 1.486 | 69.858 | STUD M6 x 18mm (Inside) |
| 3 | 25.923 | 69.858 | STUD M6 x 18mm (Inside) |
| 4 | 25.923 | 1.945 | STUD M6 x 18mm (Inside) |
| 5 | 1.486 | 35.902 | STUD M6 x 18mm (Inside) |
| 6 | 25.923 | 35.902 | STUD M6 x 18mm (Inside) |
| 7 | 1.893 | 2.350 | STUD M6 x 18mm (Inside) |
| 8 | 1.893 | 69.524 | STUD M6 x 18mm (Inside) |
| 9 | 25.516 | 69.524 | STUD M6 x 18mm (Inside) |
| 10 | 25.516 | 2.350 | STUD M6 x 18mm (Inside) |
| 11 | 27.663 | 66.896 | CLOSING BAR STUD (Inside) |
| 12 | 27.663 | 4.907 | CLOSING BAR STUD (Inside) |
| 13 | 14.889 | 1.435 | STUD M6 x 18mm (Inside) |
| ----- | | | |
| 14 | 27.663 | 35.902 | 885 ESL2A |

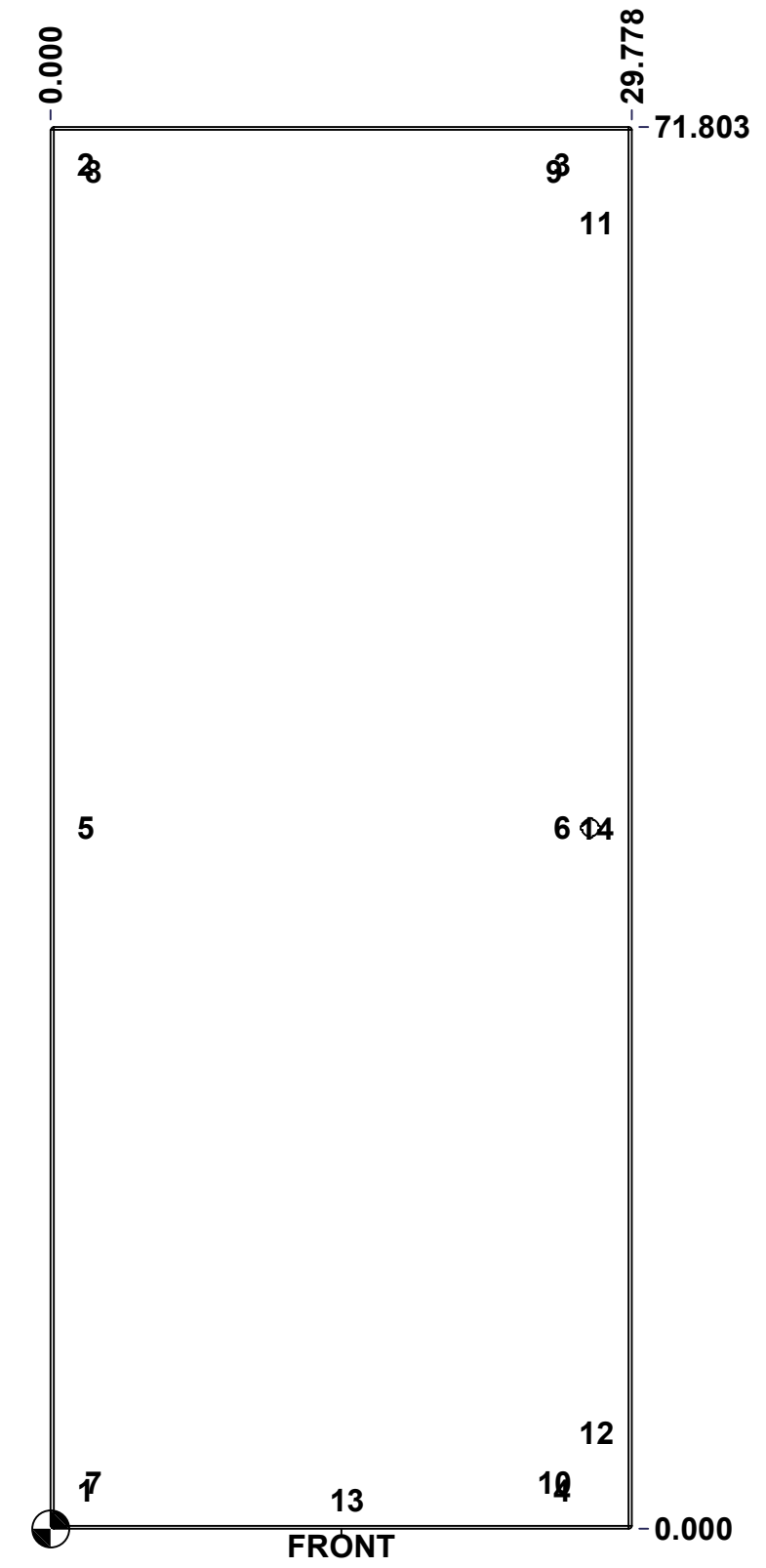

| | | |
|---|--------------------------|--------|
| | Description | Status |
| | 5412ESBU 72" x 30" Cover | (NULL) |
| Part Number Numéro Pièce 5412ESBU723024THNOIPC | Rev. | 9 |
| | 0 | 16 |

This drawing is confidential and must not be reproduced or used without the consent of EXM

Ce dessin est confidentiel et ne doit pas être reproduit ou utilisé sans le consentement de EXM

| No. | Revisions | Date | By/Par |
|-----|-----------|------|--------|
| | | | |
| | | | |
| | | | |
| | | | |
| | | | |

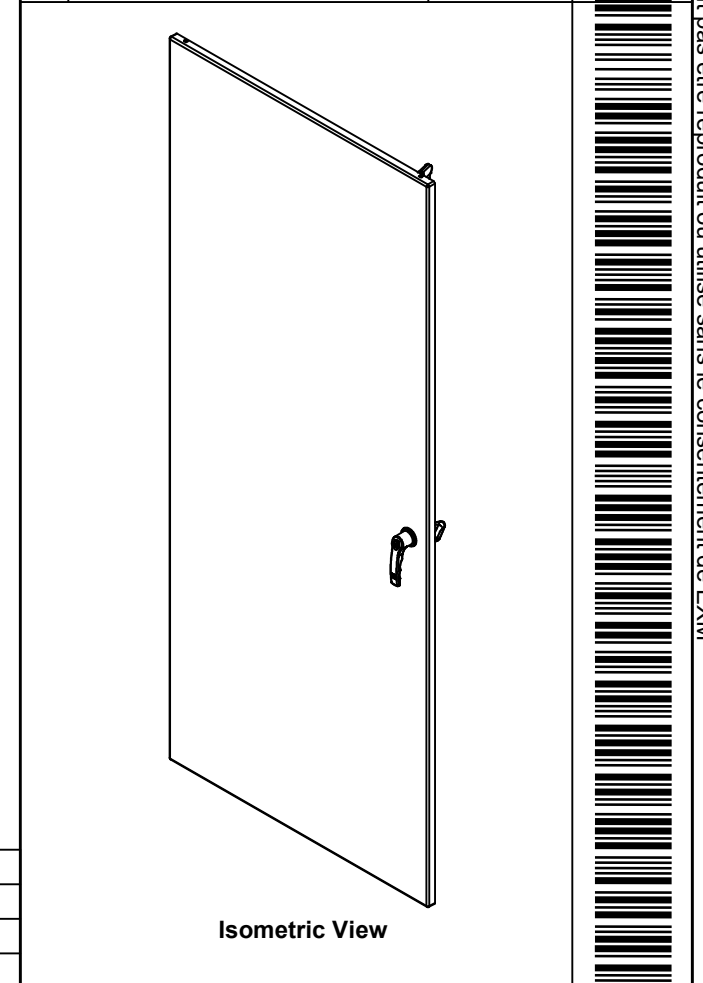

| | | | |
|----|-----------------------------|----|--|
| 2 | STK-Q-90042 | 4 | 5412 ES - Cabinet Closing Bar End (Small) |
| 2 | STK-Q-45655-72 | 0 | 5412 ES - Closing Bar |
| 1 | STK-Q-50536 | 13 | 5412 ES - Handle Cam Clockwise (Grip 32mm) |
| 1 | STK-Q-90051 | 3 | 5412 ES - Handle Cam Spacer |
| 1 | 885 ESL2A | 4 | 5412 ES Key Lock L-Handle (3 Pts) |
| 2 | STK-S-00100 | 0 | 3.5" x 2" Silver Milar Flexcon Sticker |
| 10 | STK-Q-07250 | 2 | M6 x 16mm Collar Nut |
| 2 | STK-Q-46020-24 | 5 | 5412 ES Vertical Door Stiffener 24" |
| 2 | STK-Q-46020-72 | 5 | 5412 ES Vertical Door Stiffener 72" |
| 1 | 5412ESBU723024THNOI PI-C | 0 | 5412ESBU 72" x 30" Cover Insulation |
| 1 | STK-P-02400S | 0 | Powder Paint (Asa-61 Grey / Smooth) |
| 1 | STK-Q-46515 | 3 | 5412 ES Door Support with Brass Insert |
| 2 | STK-Q-16405 | 6 | Guide Stud - Small (No Paint Cap Required) |
| 11 | STK-Q-16055 | 1 | M6 x 18mm Stud (No Paint Cap Required) |
| 4 | STK-A-33005 | 4 | 5412 ESBU Hinge 180° (Body Part) |
| 1 | 5412ESBU723024THNOI PG | 0 | 5412ESBU 72" x 30" Cover Gasket Part |
| 1 | 5412ESBU723024THNOI PC-P | 0 | 5412ESBU 72" x 30" Cover Part |

| QTY | Part Number | Rev | Description |
|------------|-------------|-----|-------------|
| Parts List | | | |



Tél: (450) 979-4373
Fax: (450) 979-4626
www.exmweb.com

Flatness
Aplatissement
Max 3.0mm

Projection

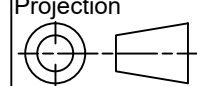

| | |
|---|-----------------------|
| Customer Client | Date |
| Drawn By Dessiné Par BoxCad: BoxCad | Date 14-Apr-23 |
| Material Matière 14 Ga Cold Rolled A1008 CS Type B (1.7mm) | |
| Color Couleur Asa-61 Grey | Finish Fini Smooth |
| Description 5412ESBU 72" x 30" Cover | Detail Rev. |
| Part Number Numéro Pièce 5412ESBU723024THNOIPC | Rev. 0 |

This drawing is confidential and must not be reproduced or used without the consent of EXM

Ce dessin est confidentiel et ne doit pas être reproduit ou utilisé sans le consentement de EXM

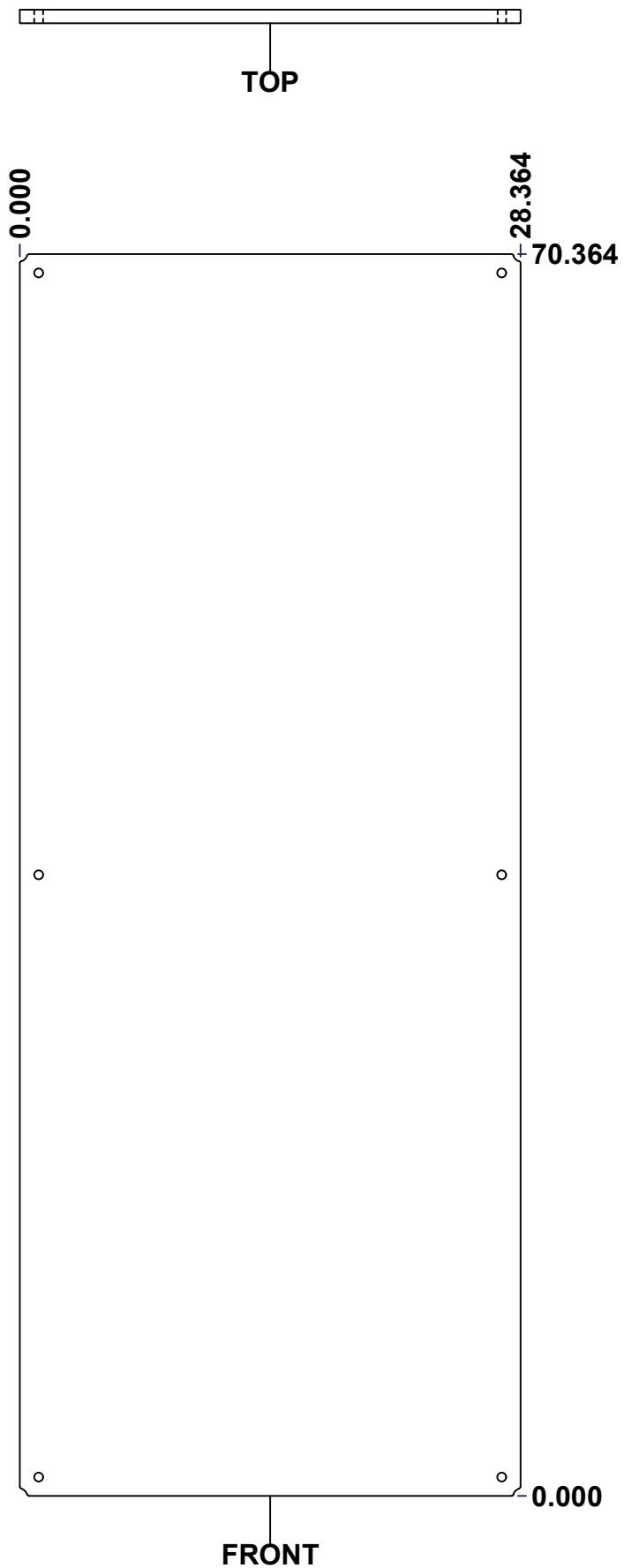

| No. | Revisions | Date | By/Par |
|-----|-----------|------|--------|
| | | | |
| | | | |
| | | | |
| | | | |

Isometric View

| | | | |
|---|--|---------------------------|----------------|
| <p>Tél: (450) 979-4373 Fax: (450) 979-4626 www.exmweb.com</p> | | Flatness Aplatissement | |
| | | Max 3.0mm | |
| Customer Client | | Date | |
| Drawn By Dessiné Par | | Date | |
| Material Matière | | Polyisocyanurate | |
| Color Couleur | | Aluminum | Finish Fini |
| Description | | Detail Rev. | |
| 5412ESBU 72" x 30" Back Insulation | | | |
| Part Number Numéro Pièce | | Rev. | 11 |
| SEE BILL OF MATERIAL ON LAST PAGE | | 0 | 16 |

This drawing is confidential and must not be reproduced or used without the consent of EXM

Ce dessin est confidentiel et ne doit pas être reproduit ou utilisé sans le consentement de EXM

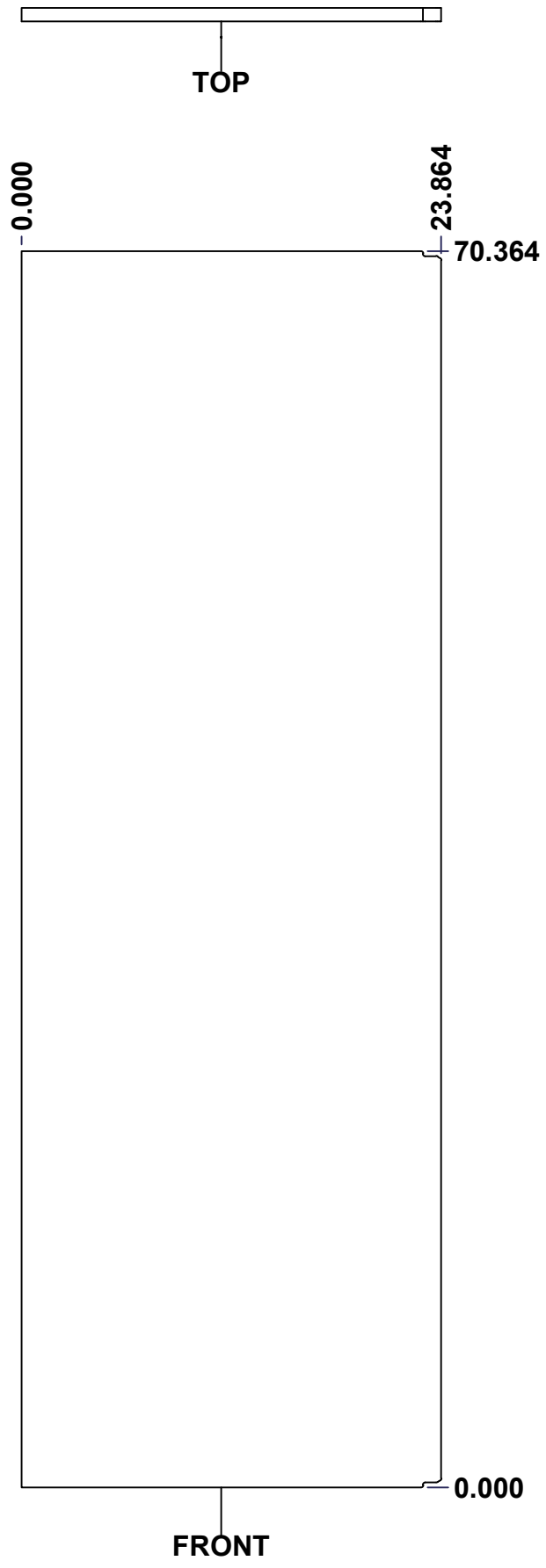

| No. | Revisions | Date | By/Par |
|-----|-----------|------|--------|
| | | | |
| | | | |
| | | | |
| | | | |

Isometric View

| | | |
|---|---------------------------|---------------------------|
| <p>Tél: (450) 979-4373 Fax: (450) 979-4626 www.exmweb.com</p> | | Flatness Aplatissement |
| | | Max 3.0mm |
| Projection | | |
| Customer Client | Date | |
| Drawn By Dessiné Par | BoxCad: Patrick Deschenes | Date 23-Jan-07 |
| Material Matière | Polyisocyanurate | |
| Color Couleur | Aluminum | Finish Fini N/A |
| Description | Detail Rev. | |
| 5412ESBU 72" x 30" Left Insulation | | |
| Part Number Numéro Pièce | Rev. | 12 |
| SEE BILL OF MATERIAL ON LAST PAGE 5412ESBU723024THNOIPI-LS 0 | | 16 |

This drawing is confidential and must not be reproduced or used without the consent of EXM

Ce dessin est confidentiel et ne doit pas être reproduit ou utilisé sans le consentement de EXM

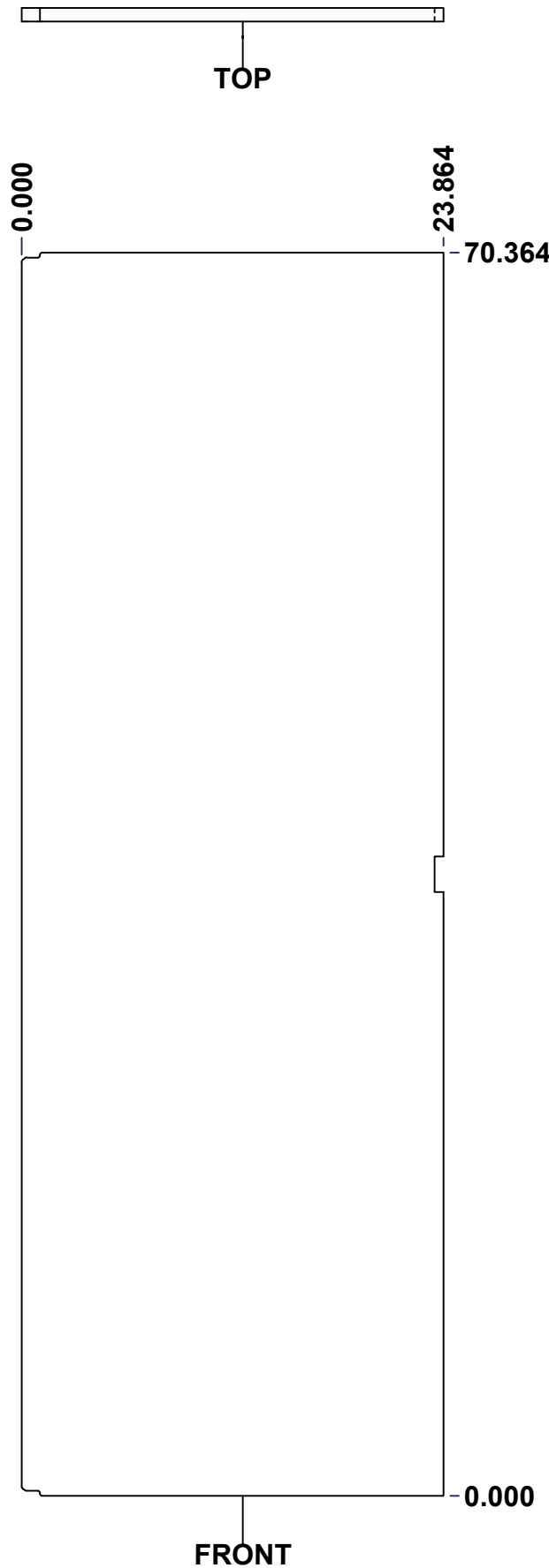

| No. | Revisions | Date | By/Par |
|-----|-----------|------|--------|
| | | | |
| | | | |
| | | | |
| | | | |

Isometric View

| | | |
|---|--------------------|---|
| <p>Tél: (450) 979-4373 Fax: (450) 979-4626 www.exmweb.com</p> | | Flatness Aplatissement <p>Max 3.0mm</p> |
| Customer Client Date | | Projection |
| Drawn By Dessiné Par BoxCad: Patrick Deschenes | | Date 23-Jan-07 |
| Material Matière Polyisocyanurate | | |
| Color Couleur Aluminum | Finish Fini N/A | |
| Description 5412ESBU 72" x 30" Right Insulation | | Detail Rev. |
| Part Number Numéro Pièce 5412ESBU723024THNOIPI-RS 0 | | Rev. 13 |

SEE BILL OF MATERIAL ON LAST PAGE

This drawing is confidential and must not be reproduced or used without the consent of EXM

Ce dessin est confidentiel et ne doit pas être reproduit ou utilisé sans le consentement de EXM

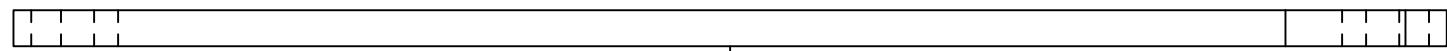

TOP

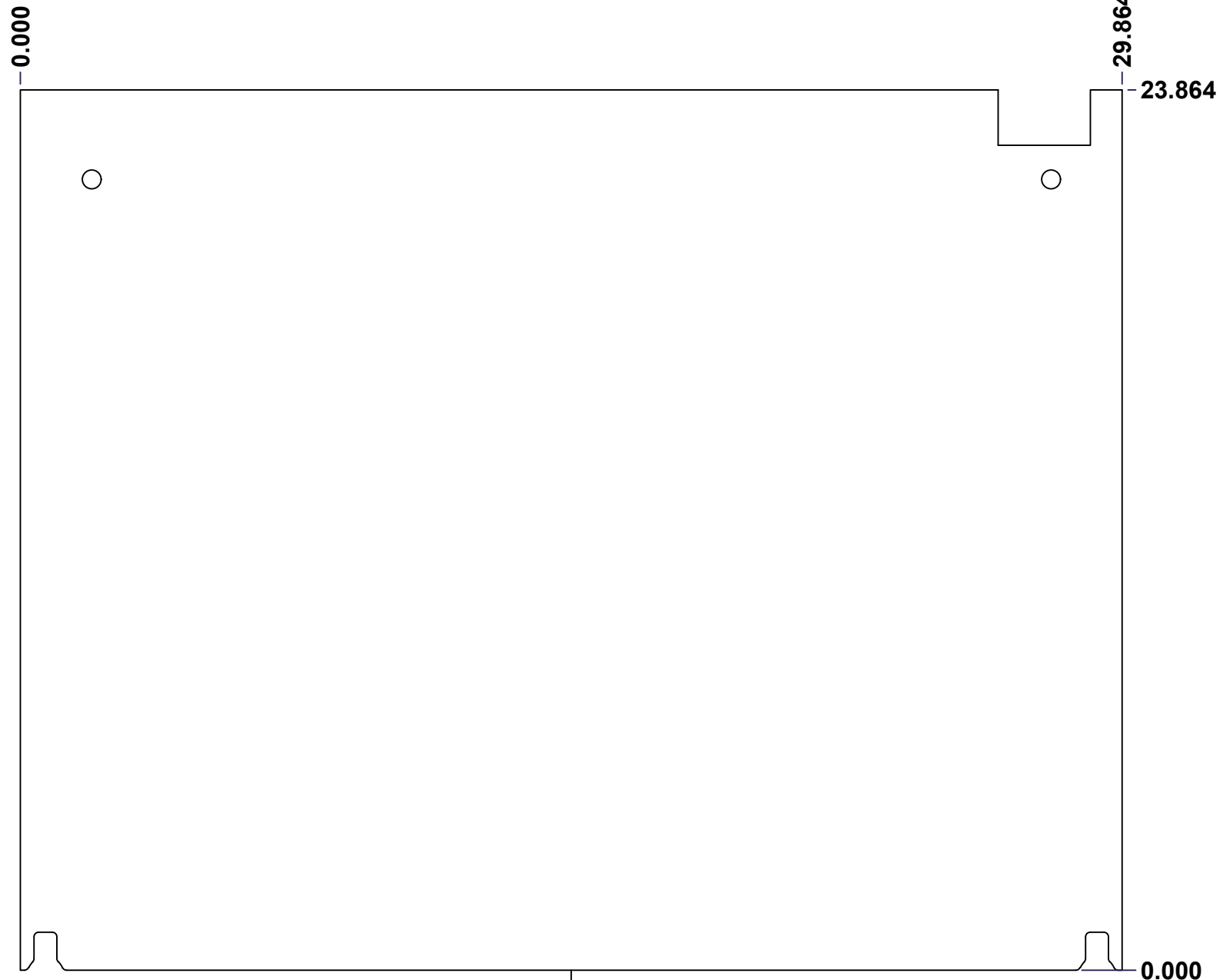

FRONT

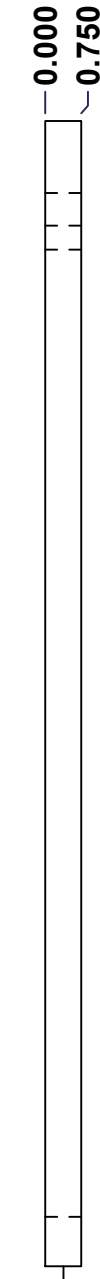

RIGHT

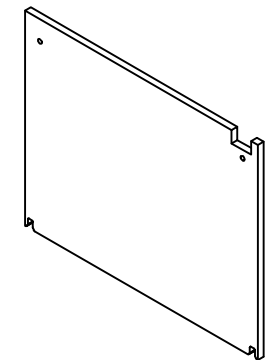

Isometric View



Tél: (450) 979-4373
 Fax: (450) 979-4626
www.exmweb.com

Flatness
Aplatissement

Max 3.0mm

Projection

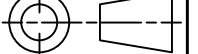

Customer Client

Date

Drawn By / Dessiné Par: BoxCad: Patrick Deschenes

Date: 23-Jan-07

Material / Matière: Polyisocyanurate

Color / Couleur: Aluminum

Finish / Fini: N/A

Description: 5412ESBU 72" x 30" Top and Bottom Insulation

Detail Rev.

Part Number / Numéro Pièce

Rev. 14

SEE BILL OF MATERIAL ON LAST PAGE 5412ESBU723024THNOIPI-TP 0

This drawing is confidential and must not be reproduced or used without the consent of EXM

Ce dessin est confidentiel et ne doit pas être reproduit ou utilisé sans le consentement de EXM

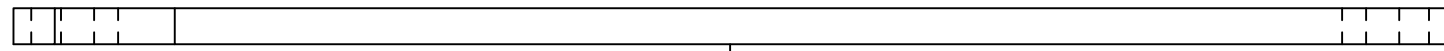

TOP

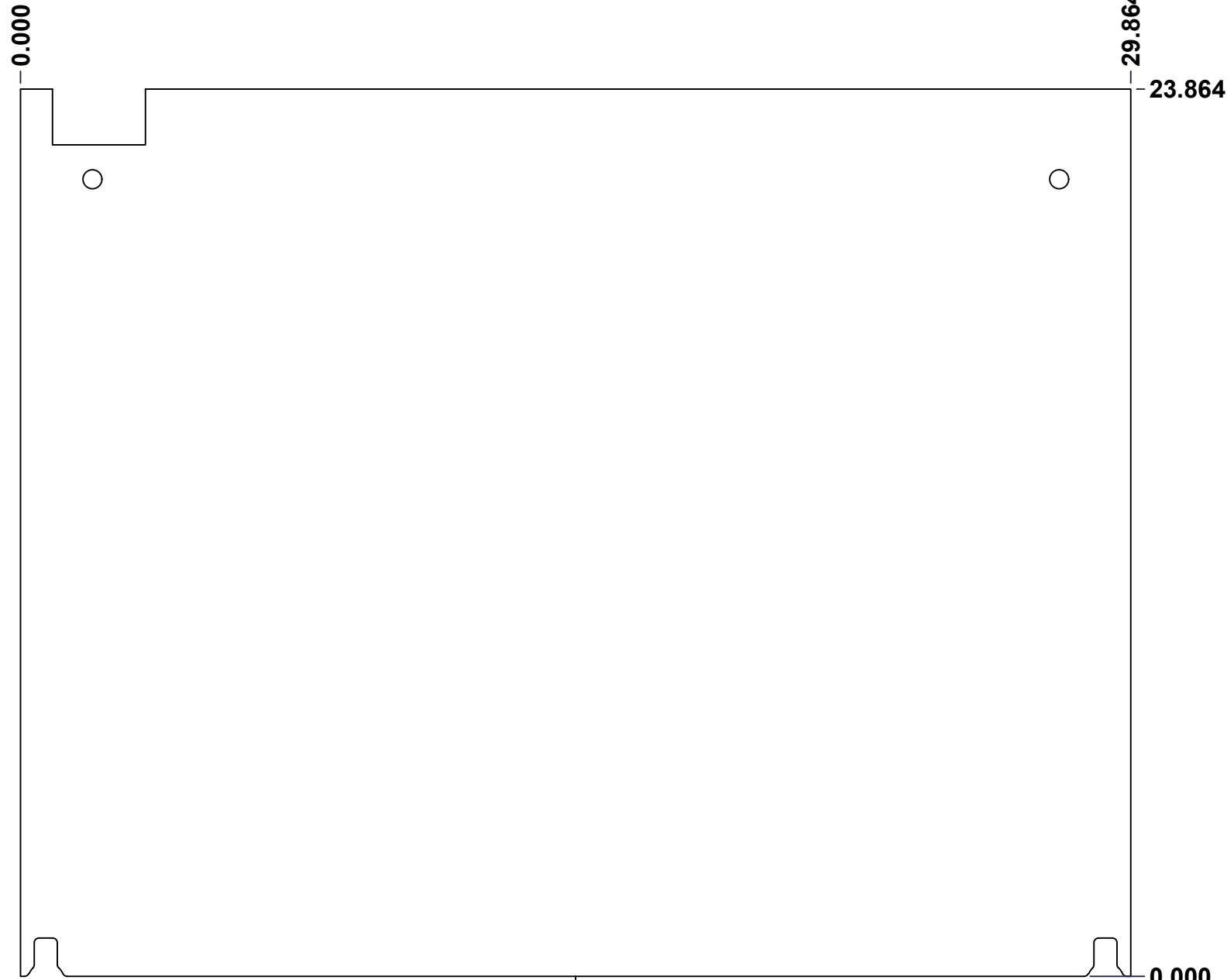

FRONT

0.000
0.750

RIGHT

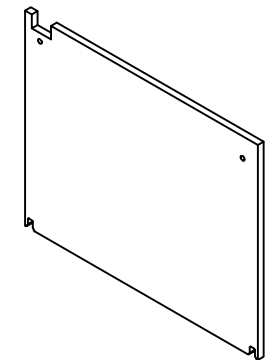

Isometric View



Tél: (450) 979-4373
Fax: (450) 979-4626
www.exmweb.com

Flatness
Aplatissement

Max 3.0mm

Projection

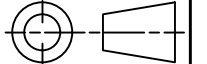

| | |
|-------------------------|------|
| Customer Client | Date |
| Drawn By Dessiné Par | Date |

BoxCad: Patrick Deschenes
23-Jan-07
Material
Matière

Polyisocyanurate

| | | | |
|------------------|----------|----------------|-----|
| Color Couleur | Aluminum | Finish Fini | N/A |
|------------------|----------|----------------|-----|

| | |
|---|-------------|
| Description | Detail Rev. |
| 5412ESBU 72" x 30" Top and Bottom Insulation | |

| | | |
|-----------------------------|------|----|
| Part Number Numéro Pièce | Rev. | 15 |
|-----------------------------|------|----|

SEE BILL OF MATERIAL ON LAST PAGE 5412ESBU723024THNOIPI-BT 0

This drawing is confidential and must not be reproduced or used without the consent of EXM

Ce dessin est confidentiel et ne doit pas être reproduit ou utilisé sans le consentement de EXM

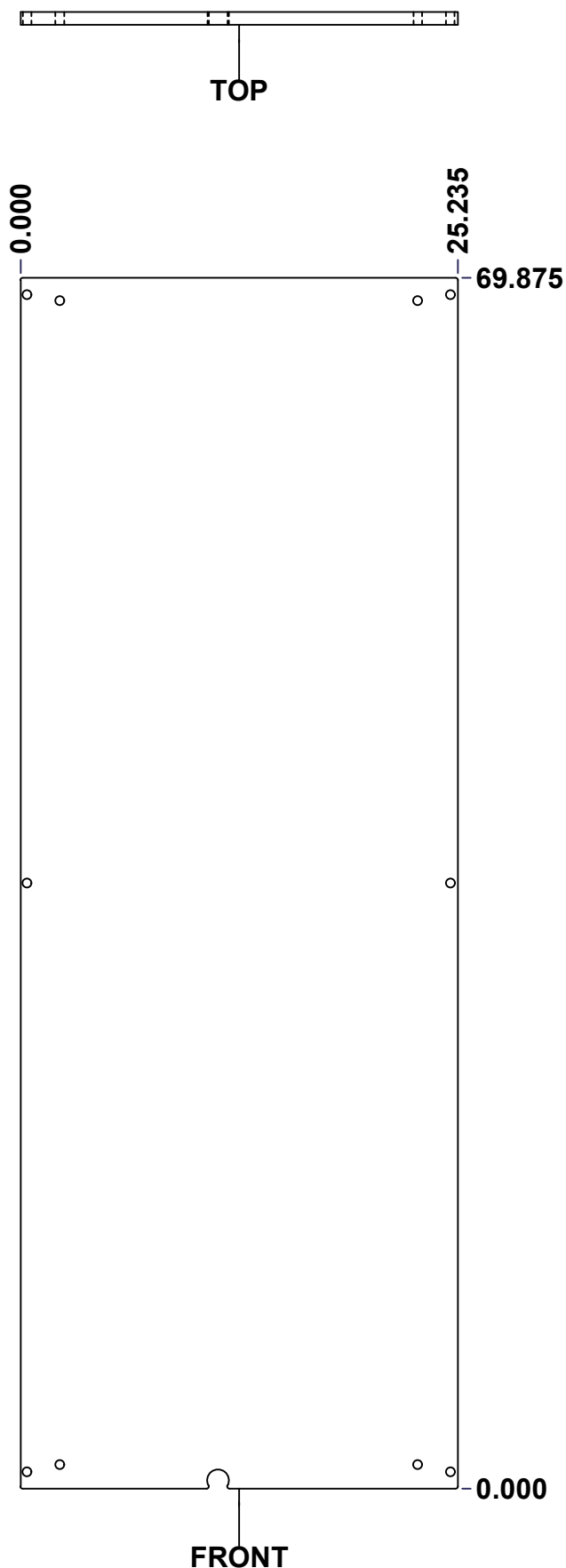

| No. | Revisions | Date | By/Par |
|-----|-----------|------|--------|
| | | | |
| | | | |
| | | | |
| | | | |

Isometric View

| | | |
|--|---------------------------|--|
| Tél: (450) 979-4373 Fax: (450) 979-4626 www.exmweb.com | | Flatness Aplatissement Max 3.0mm |
| Projection | | Date 23-Jan-07 |
| Customer Client | Date | |
| Drawn By Dessiné Par | BoxCad: Patrick Deschenes | Date 23-Jan-07 |
| Material Matière | Polyisocyanurate | |
| Color Couleur | Aluminum | Finish Fini N/A |
| Description 5412ESBU 72" x 30" Cover Insulation | | Detail Rev. |
| Part Number Numéro Pièce | Rev. 16 | 16 |

SEE BILL OF MATERIAL ON LAST PAGE 5412ESBU723024THNOIPI-C 0