

This drawing is confidential and must not be reproduced or used without the consent of EXM

Ce dessin est confidentiel et ne doit pas être reproduit ou utilisé sans le consentement de EXM

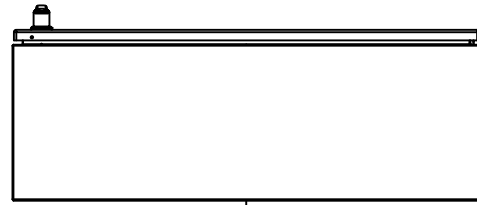

TOP

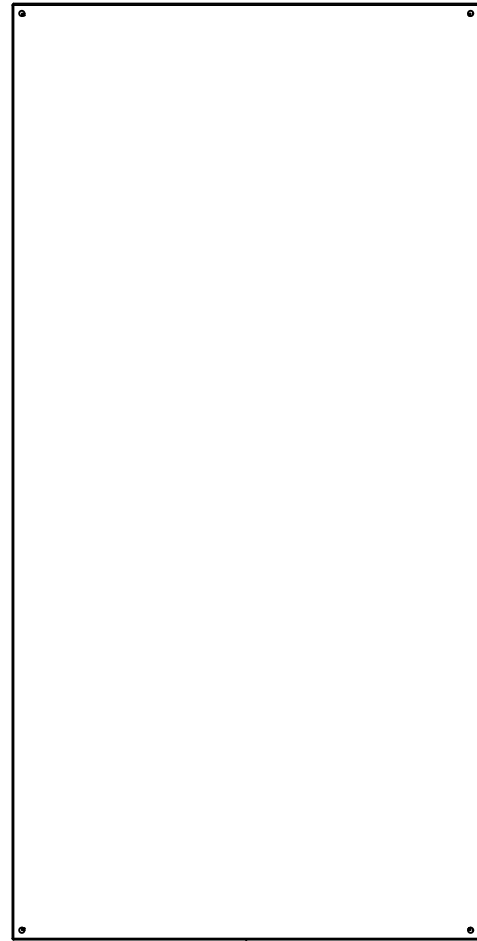

BACK

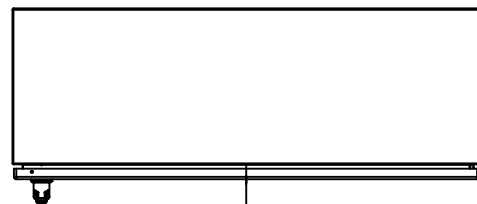

BOTTOM

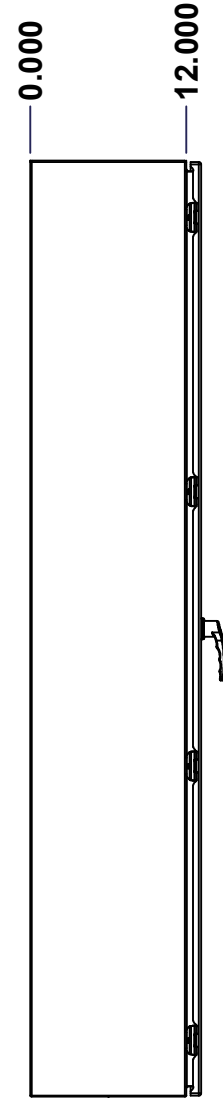

LEFT

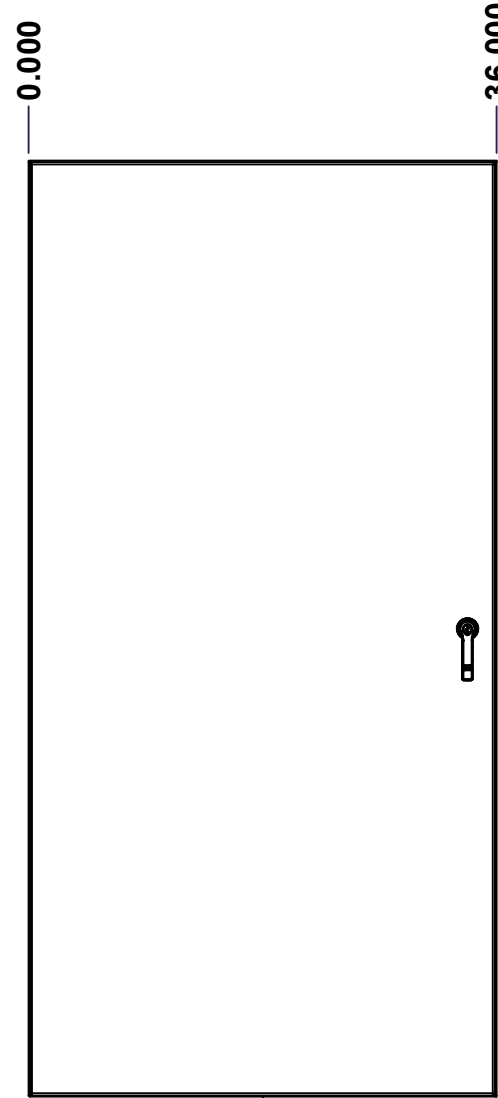

FRONT

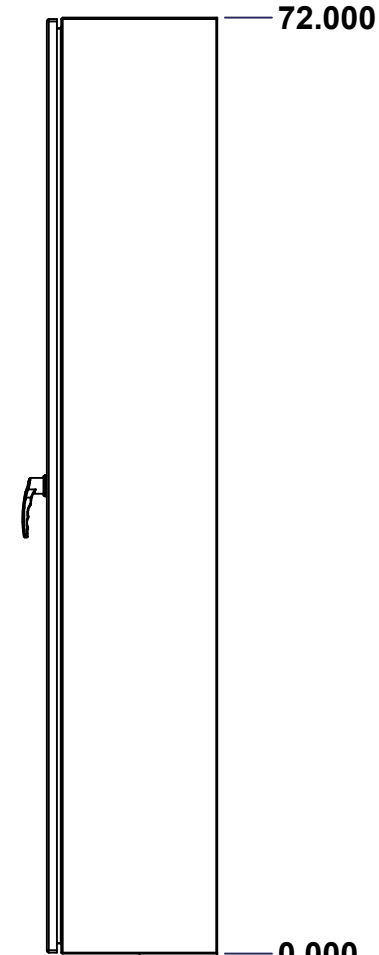

RIGHT

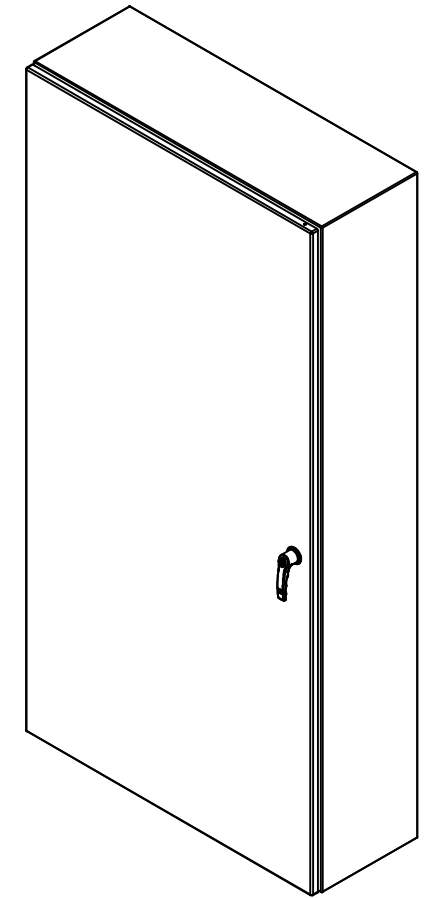

Isometric View

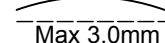
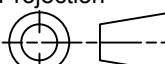

No.	Revisions	Date	By/Par

 Tél: (450) 979-4373 Fax: (450) 979-4626 www.exmweb.com		Flatness Aplatissement  Max 3.0mm Projection 
Customer Client	Date	
Drawn By Dessiné Par	BoxCad: BoxCad	Date 12-Mar-14
Material Matière	14 Ga Cold Rolled A1008 CS Type B (1.7mm)	
Color Couleur	Asa-61 Grey	Finish Fini Smooth
Description	Detail Rev.	
5412ESBU 72" x 36" x 12" Assembly		
Part Number Numéro Pièce	Rev.	1
5412ESBU723612	0	9

SEE BILL OF MATERIAL ON LAST PAGE

This drawing is confidential and must not be reproduced or used without the consent of EXM

Ce dessin est confidentiel et ne doit pas être reproduit ou utilisé sans le consentement de EXM

NOTE	
ITEM	DESCRIPTION
1	NEMA 4/12 Enclosure
2	C/W Standard ground studs on box and cover
3	C/W Standard door stiffener
4	C/W Standard inner panel (Included)
5	C/W Standard inner panel mounting studs

No.	Revisions	Date	By/Par

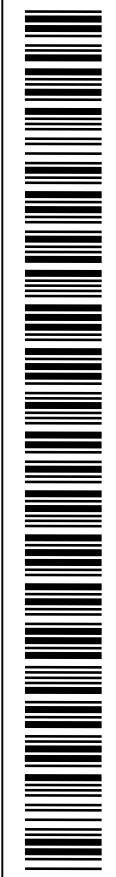
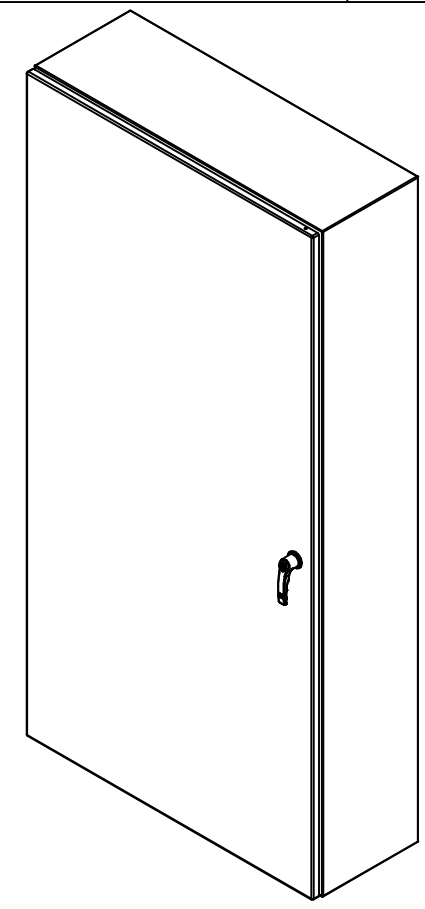

Isometric View



Tél: (450) 979-4373
 Fax: (450) 979-4626
www.exmweb.com

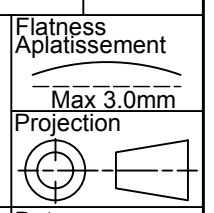

Customer Client	Date
Drawn By / Dessiné Par: BoxCad: BoxCad	Date: 12-Mar-14
Material / Matière: 14 Ga Cold Rolled A1008 CS Type B (1.7mm)	

Color / Couleur: Asa-61 Grey	Finish / Fini: Smooth
Description: 5412ESBU 72" x 36" x 12" Assembly	
Part Number / Numéro Pièce: 5412ESBU723612	Rev. / Révis: 0

PACKING		
ITEM	QTY	DESCRIPTION
Cardboard sleeve	2	Top and Bottom
Cardboard strip	2	Between back of enclosure and inner panel
Plastic bag	1	To protect cover surface and inside gasket
Cardboard corner	4	To reinforced for the plastic strap tightening
Plastic strap - Black	2	To Squeeze the 2 cardboard sleeve together
Packaging label	3	White label with PN
Plastic strap- Green	2	To secure the enclosure to the wood pallet
Wood Pallet	1	2" deeper and 3" larger than enclosure size

Qty	Part Number	Rev	Description
1	881 SP7236G	0	881 SP - Inner Panel
4	STK-K-01320	0	5412 ES Inner Panel Accessory Kit
1	STK-K-01800	5	5412 ES Accessory Kit
1	5412ESBU723612C	0	5412ESBU 72" x 36" Cover
1	5412ESBU723612B	0	5412ESBU 72" x 36" x 12" Body
8	STK-Q-04050-08	0	M6 x 8mm Hexagon Socket Head Machine Screw

Parts List

This drawing is confidential and must not be reproduced or used without the consent of EXM

Ce dessin est confidentiel et ne doit pas être reproduit ou utilisé sans le consentement de EXM

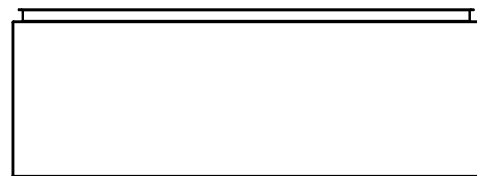

TOP

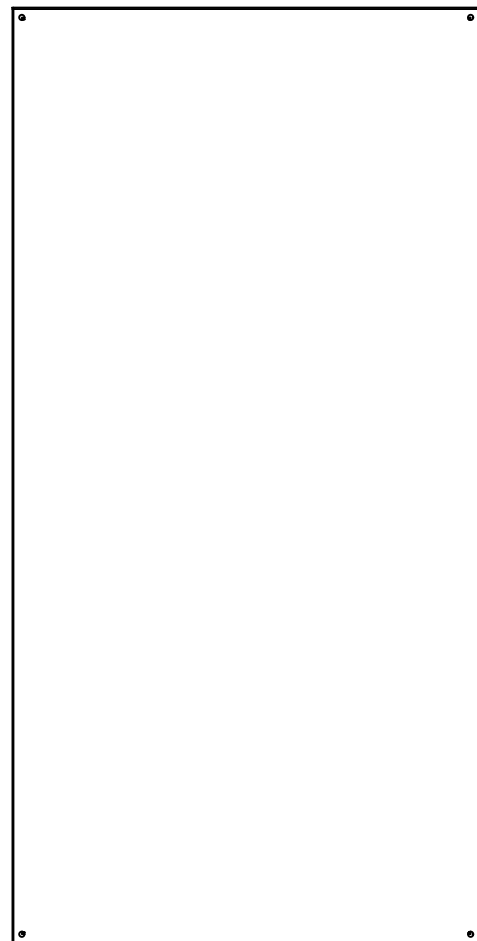

BACK

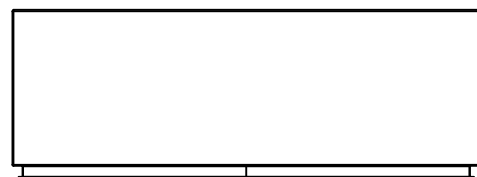

BOTTOM

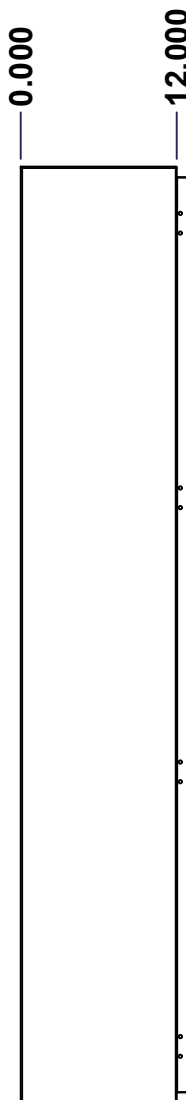

LEFT

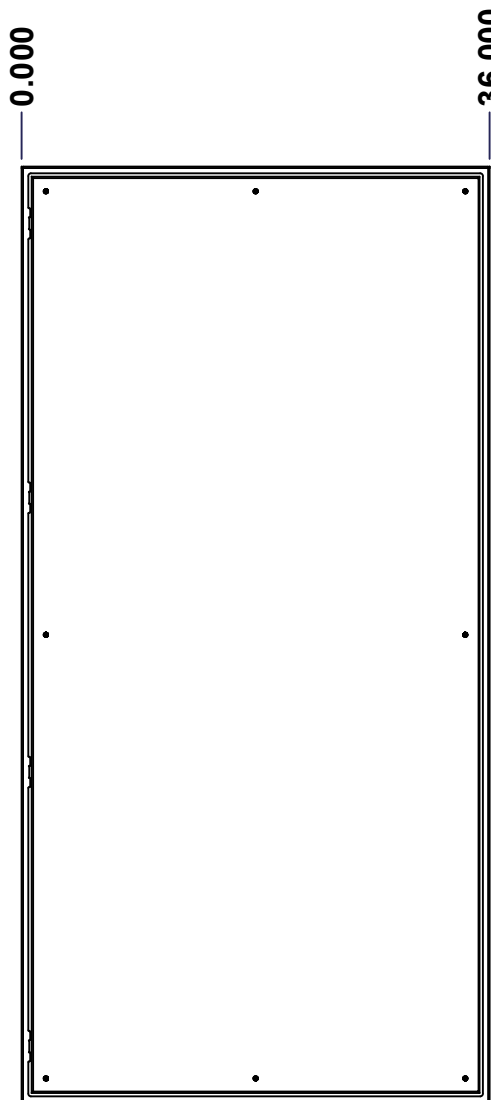

FRONT

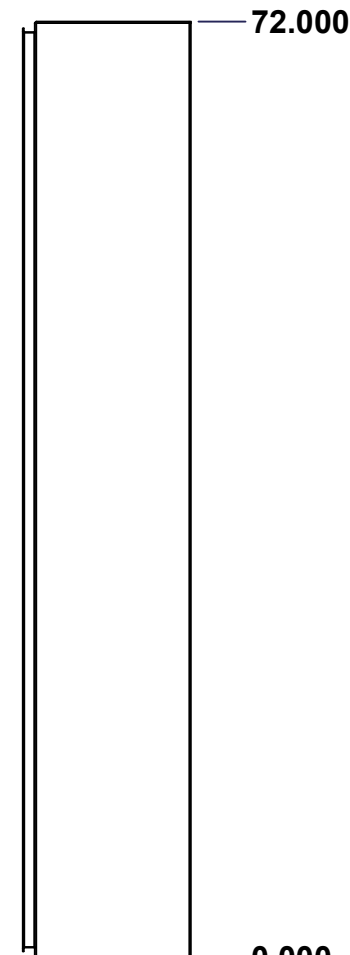

RIGHT

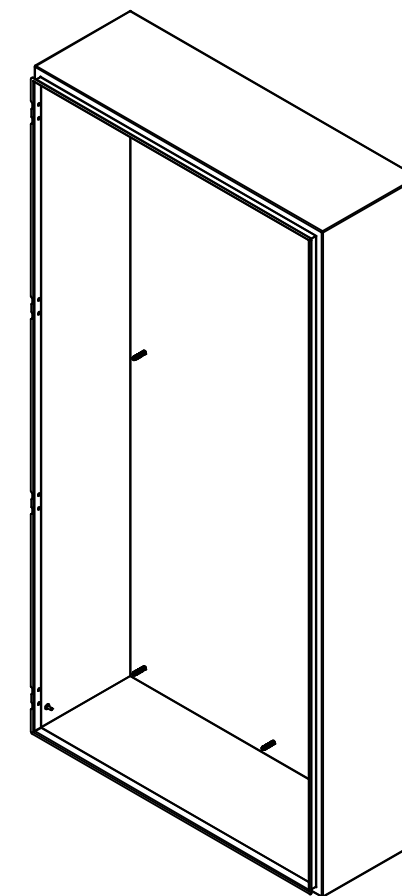

Isometric View

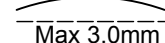

No.	Revisions	Date	By/Par

 Tél: (450) 979-4373 Fax: (450) 979-4626 www.exmweb.com		Flatness Aplatissement  Max 3.0mm
Customer Client		Date
Drawn By Dessiné Par BoxCad: BoxCad		Date 12-Mar-14
Material Matière 14 Ga Cold Rolled A1008 CS Type B (1.7mm)		
Color Couleur Asa-61 Grey	Finish Fini Smooth	
Description 5412ESBU 72" x 36" x 12" Body		Detail Rev.
Part Number Numéro Pièce 5412ESBU723612B		Rev. 3 0

SEE BILL OF MATERIAL ON LAST PAGE

This drawing is confidential and must not be reproduced or used without the consent of EXM

Ce dessin est confidentiel et ne doit pas être reproduit ou utilisé sans le consentement de EXM

STANDARD FEATURES ARE NOT LISTED IN THIS HOLE TABLE			
HOLE TABLE - LEFT VIEW (CUSTOM FEATURE ONLY)			
CUT-OUT	XDIM	YDIM	DESCRIPTION
1	10.500	2.000	GND STUD M6 x 16mm (Inside)

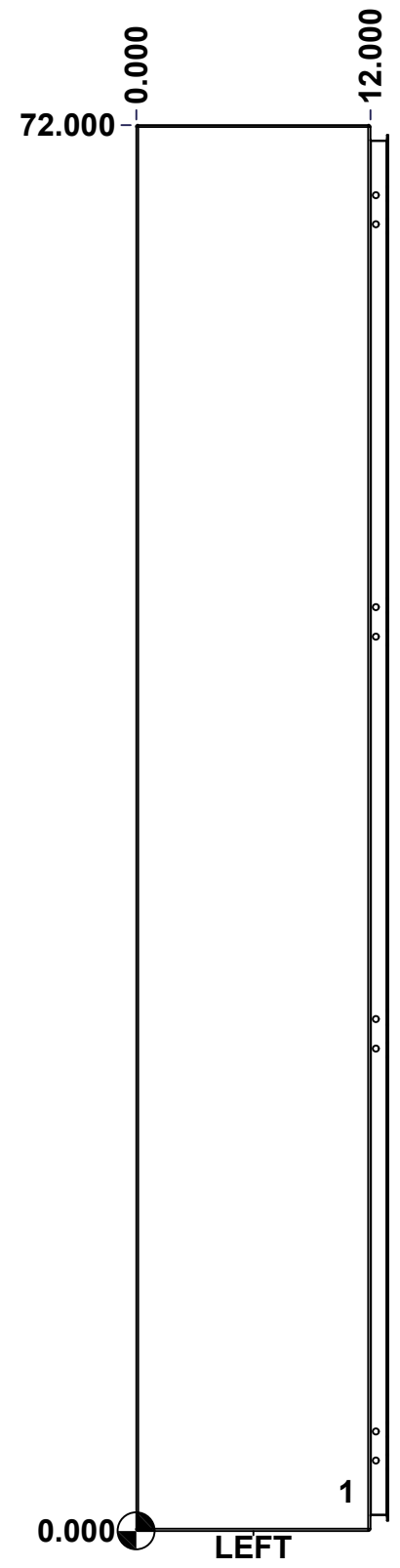

	Description	Status	
	5412ESBU 72" x 36" x 12" Body	(NULL)	
	Part Number Numéro Pièce	Rev.	
	5412ESBU723612B	0	4 9

This drawing is confidential and must not be reproduced or used without the consent of EXM

Ce dessin est confidentiel et ne doit pas être reproduit ou utilisé sans le consentement de EXM

STANDARD FEATURES ARE NOT LISTED IN THIS HOLE TABLE

HOLE TABLE - BACK VIEW (CUSTOM FEATURE ONLY)

CUT-OUT	XDIM	YDIM	DESCRIPTION
1	1.875	1.875	IP STUD M8 x 35mm (Inside)
2	1.875	70.125	IP STUD M8 x 35mm (Inside)
3	34.125	70.125	IP STUD M8 x 35mm (Inside)
4	34.125	1.875	IP STUD M8 x 35mm (Inside)
5	1.875	36.000	IP STUD M8 x 35mm (Inside)
6	34.125	36.000	IP STUD M8 x 35mm (Inside)
7	18.000	1.875	IP STUD M8 x 35mm (Inside)
8	18.000	70.125	IP STUD M8 x 35mm (Inside)

9	35.250	0.750	RND Ø0.390
10	35.250	71.250	RND Ø0.390
11	0.750	71.250	RND Ø0.390
12	0.750	0.750	RND Ø0.390

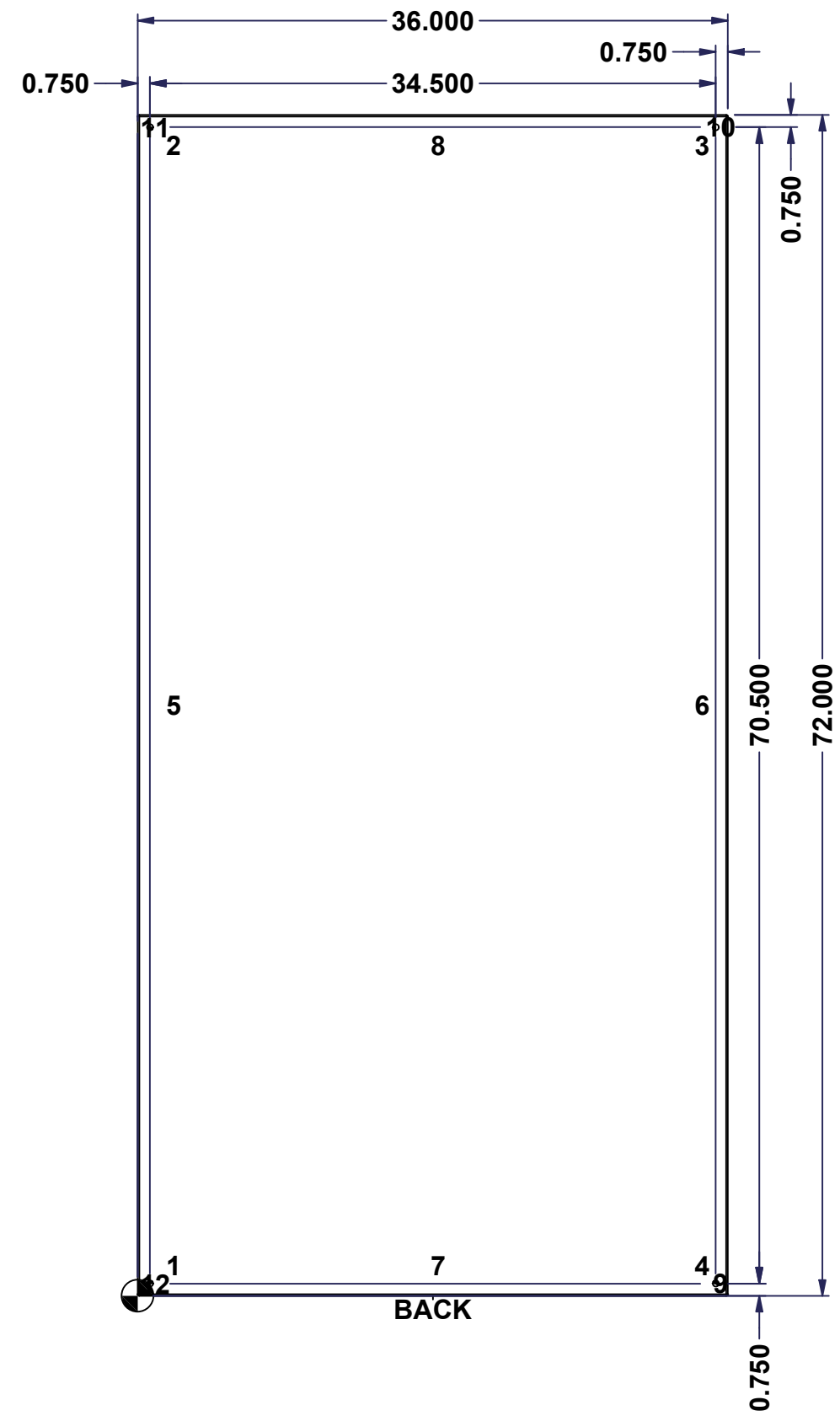

	Description	Status
	5412ESBU 72" x 36" x 12" Body	(NULL)
	Part Number Numéro Pièce	Rev.
	5412ESBU723612B	0 / 5 9

This drawing is confidential and must not be reproduced or used without the consent of EXM

Ce dessin est confidentiel et ne doit pas être reproduit ou utilisé sans le consentement de EXM

No.	Revisions	Date	By/Par

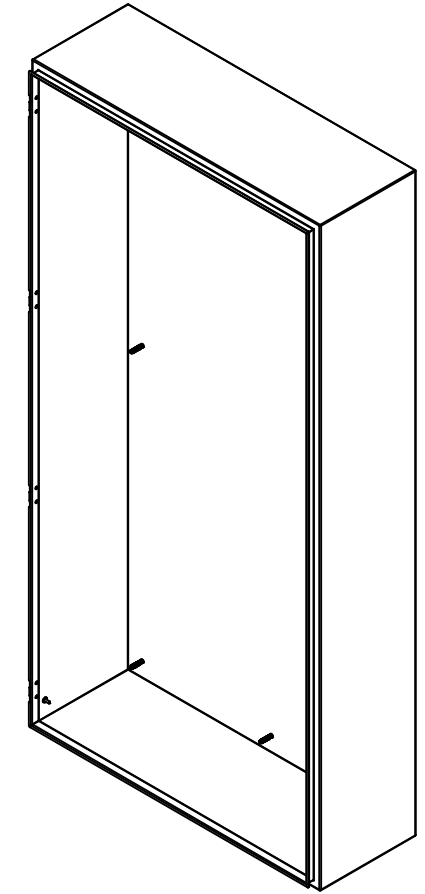

Isometric View



Tél: (450) 979-4373
 Fax: (450) 979-4626
www.exmweb.com

Flatness
Aplatissement

Max 3.0mm

Projection



Customer Client	Date
Drawn By / Dessiné Par: BoxCad: BoxCad	Date: 12-Mar-14
Material / Matière: 14 Ga Cold Rolled A1008 CS Type B (1.7mm)	
Color / Couleur: Asa-61 Grey	Finish / Fini: Smooth

Qty	Part Number	Rev	Description
1	STK-Q-16080	0	Ground Stud M6 x 16mm Steel
1	STK-P-02400S	0	Powder Paint (Asa-61 Grey / Smooth)
8	STK-Q-16005	1	Stud M8 x 35 (No Paint Cap Required)
1	5412ESBU723612B-P	0	5412ESBU 72" x 36" x 12" Body Part
Parts List			

Description: 5412ESBU 72" x 36" x 12" Body	Detail Rev.
Part Number / Numéro Pièce: 5412ESBU723612B	Rev. 0
	6 / 9

This drawing is confidential and must not be reproduced or used without the consent of EXM

Ce dessin est confidentiel et ne doit pas être reproduit ou utilisé sans le consentement de EXM

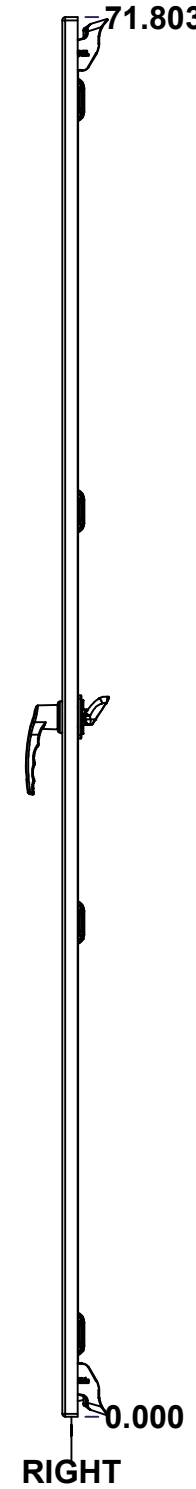
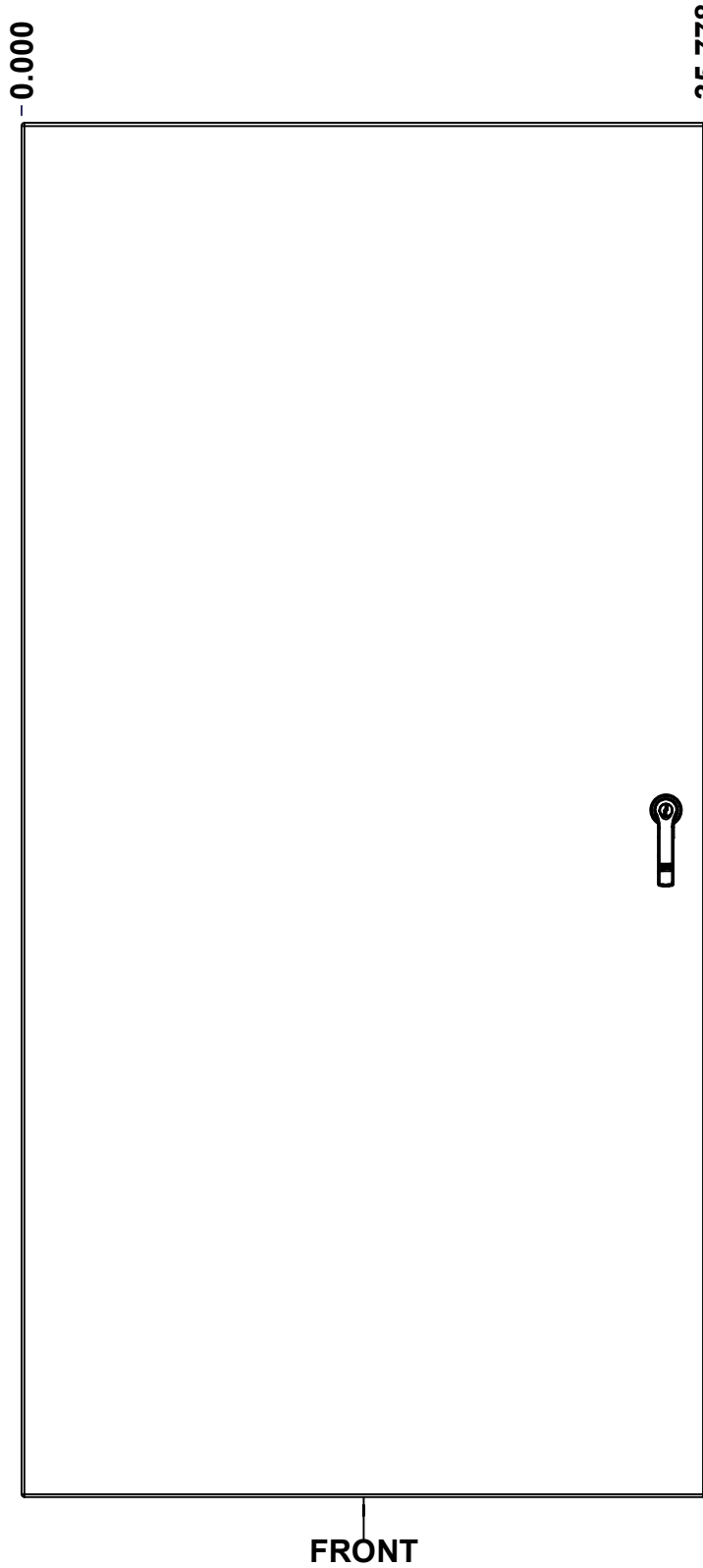
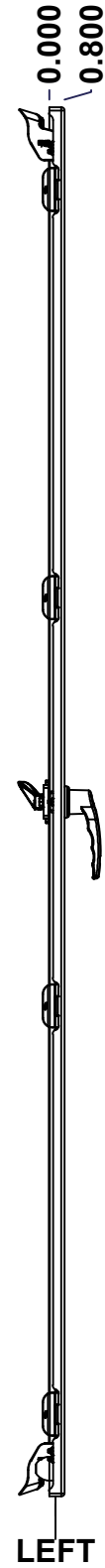
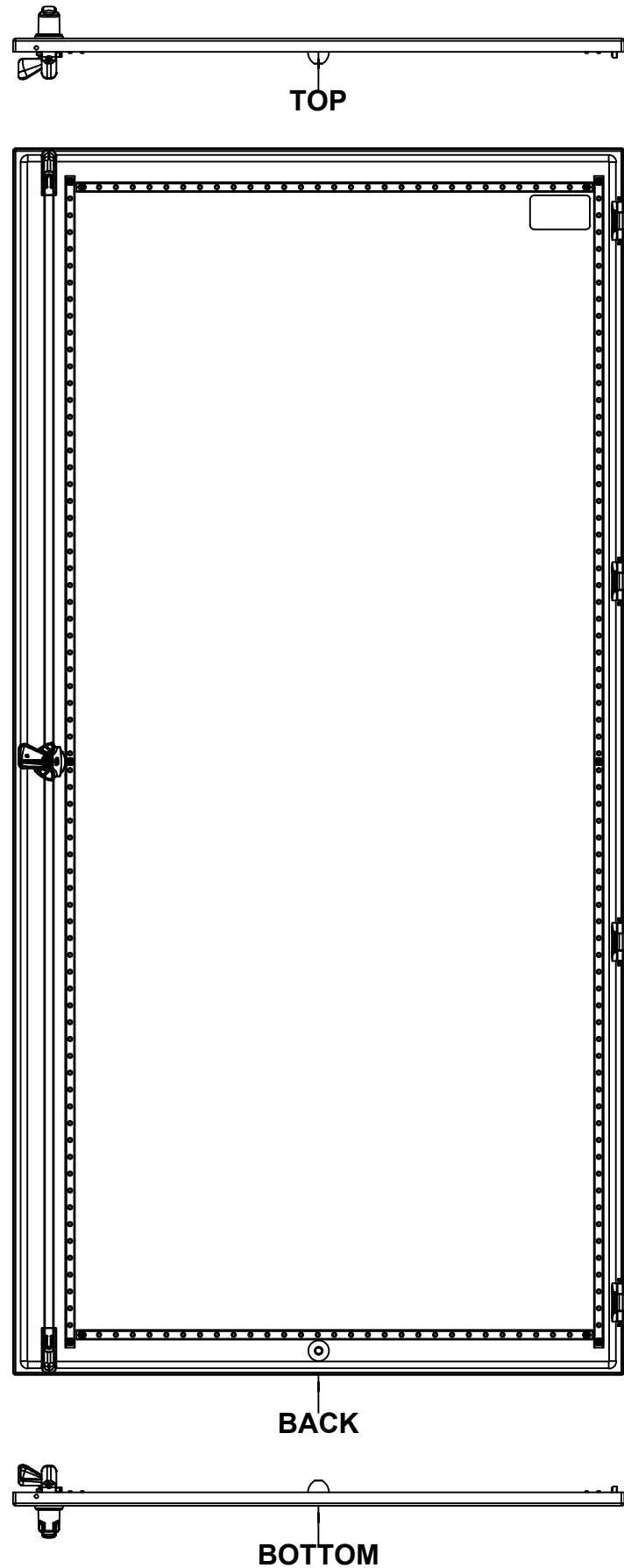

No.	Revisions	Date	By/Par

Isometric View

<p>Tél: (450) 979-4373 Fax: (450) 979-4626 www.exmweb.com</p>		Flatness Aplatissement
		Max 3.0mm
Projection		
Customer Client	Date	
Drawn By Dessiné Par	BoxCad: BoxCad	Date 12-Mar-14
Material Matière	14 Ga Cold Rolled A1008 CS Type B (1.7mm)	
Color Couleur	Asa-61 Grey	Finish Fini Smooth
Description		Detail Rev.
5412ESBU 72" x 36" Cover		
Part Number Numéro Pièce	Rev. 7	9
5412ESBU723612C		0

SEE BILL OF MATERIAL ON LAST PAGE

This drawing is confidential and must not be reproduced or used without the consent of EXM

Ce dessin est confidentiel et ne doit pas être reproduit ou utilisé sans le consentement de EXM

STANDARD FEATURES ARE NOT LISTED IN THIS HOLE TABLE			
HOLE TABLE - FRONT VIEW (CUSTOM FEATURE ONLY)			
CUT-OUT	XDIM	YDIM	DESCRIPTION
1	1.486	1.945	STUD M6 x 18mm (Inside)
2	1.486	69.858	STUD M6 x 18mm (Inside)
3	32.423	69.858	STUD M6 x 18mm (Inside)
4	32.423	1.945	STUD M6 x 18mm (Inside)
5	1.486	35.902	STUD M6 x 18mm (Inside)
6	32.423	35.902	STUD M6 x 18mm (Inside)
7	2.191	2.350	STUD M6 x 18mm (Inside)
8	2.191	69.524	STUD M6 x 18mm (Inside)
9	31.718	69.524	STUD M6 x 18mm (Inside)
10	31.718	2.350	STUD M6 x 18mm (Inside)
11	33.663	66.896	CLOSING BAR STUD (Inside)
12	33.663	4.907	CLOSING BAR STUD (Inside)
13	17.889	1.435	STUD M6 x 18mm (Inside)

14	3.750	68.053	LABEL_EXM (Inside)
15	33.663	35.902	885 ESL2A

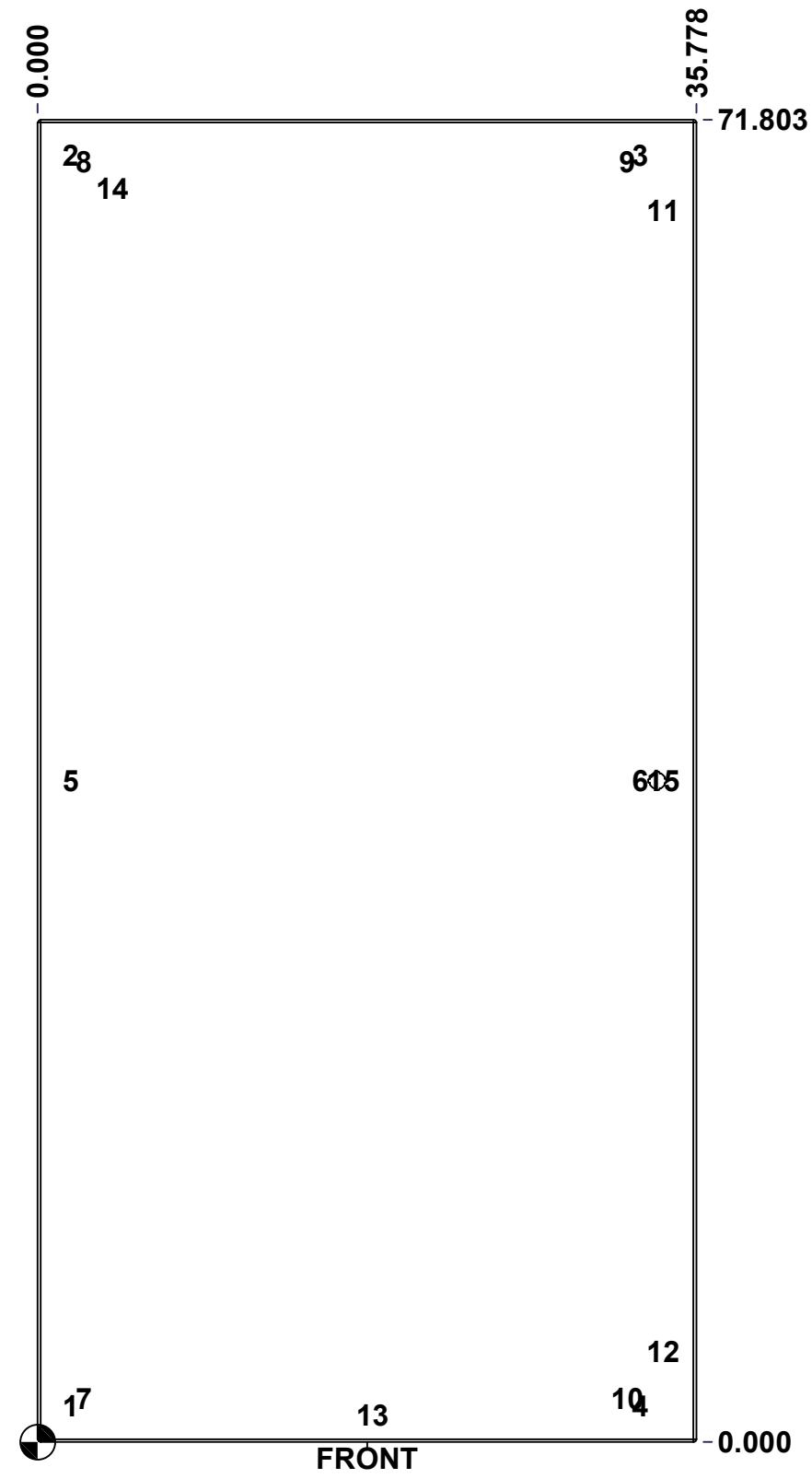

	Description	Status
	5412ESBU 72" x 36" Cover	(NULL)
	Part Number Numéro Pièce	Rev.
	5412ESBU723612C	0 / 8 / 9

This drawing is confidential and must not be reproduced or used without the consent of EXM

Ce dessin est confidentiel et ne doit pas être reproduit ou utilisé sans le consentement de EXM

No.	Revisions	Date	By/Par

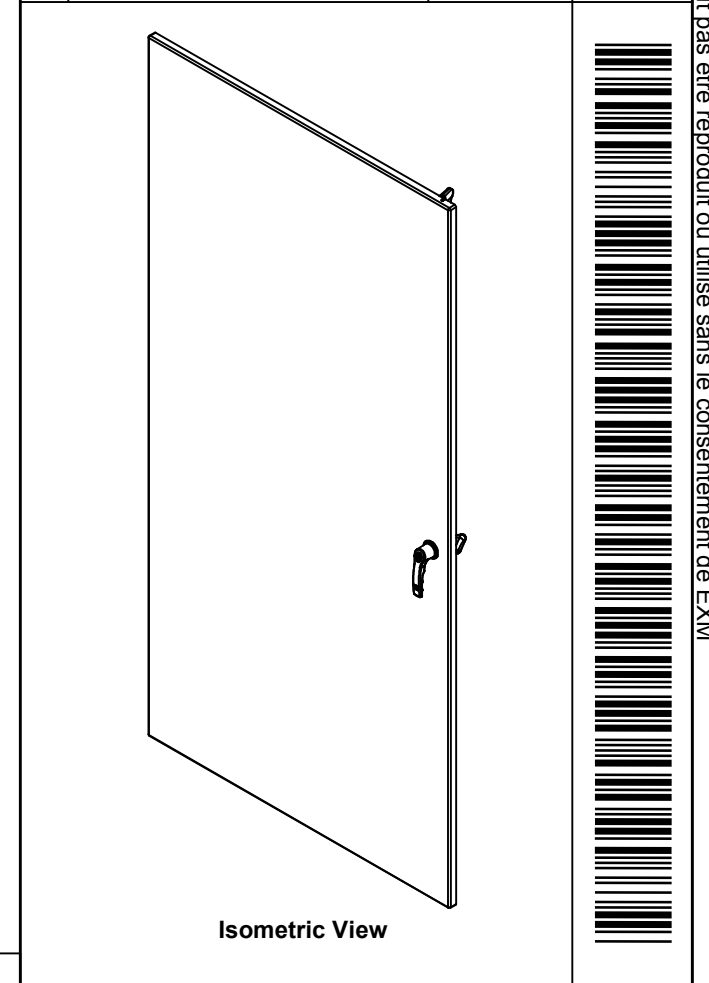

2	STK-Q-90042	4	5412 ES - Cabinet Closing Bar End (Small)
2	STK-Q-45655-72	0	5412 ES - Closing Bar
1	STK-Q-50536	13	5412 ES - Handle Cam Clockwise (Grip 32mm)
1	STK-Q-90051	3	5412 ES - Handle Cam Spacer
1	885 ESL2A	4	5412 ES Key Lock L-Handle (3 Pts)
1	STK-S-00100	0	3.5" x 2" Silver Milar Flexcon Sticker
1	STK-P-02400S	0	Powder Paint (Asa-61 Grey / Smooth)
1	STK-Q-46515	3	5412 ES Door Support with Brass Insert
2	STK-Q-46025-36-3	0.1. 1	5412 ES Horizontal Door Stiffener 36" (3 Pts)
2	STK-Q-46020-72	5	5412 ES Vertical Door Stiffener 72"
2	STK-Q-16405	6	Guide Stud - Small (No Paint Cap Required)
11	STK-Q-16055	1	M6 x 18mm Stud (No Paint Cap Required)
4	STK-A-33005	4	5412 ESBU Hinge 180° (Body Part)
1	5412ESBU723612G	0	5412ESBU 72" x 36" Cover Gasket Part
1	5412ESBU723612C-P	0	5412ESBU 72" x 36" Cover Part
10	STK-Q-07220	1	M6 Nylon Insert Lock Nut
QTY	Part Number	Rev	Description
Parts List			

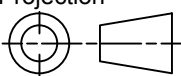
 Tél: (450) 979-4373 Fax: (450) 979-4626 www.exmweb.com	Flatness Aplatissement
	Max 3.0mm
Projection	
Customer Client	Date
Drawn By Dessiné Par	Date 12-Mar-14
Material Matière	14 Ga Cold Rolled A1008 CS Type B (1.7mm)
Color Couleur	Asa-61 Grey
Finish Fini	Smooth
Description	Detail Rev.
5412ESBU 72" x 36" Cover	
Part Number Numéro Pièce	Rev. 9
5412ESBU723612C	0 9

This drawing is confidential and must not be reproduced or used without the consent of EXM

Ce dessin est confidentiel et ne doit pas être reproduit ou utilisé sans le consentement de EXM

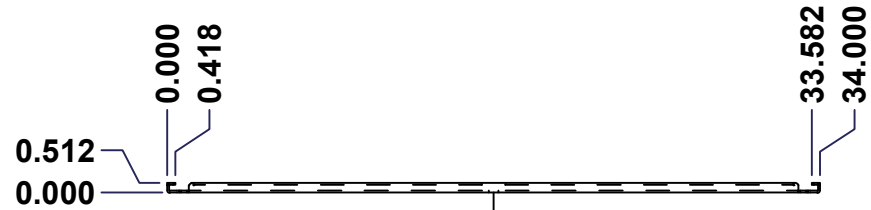

TOP

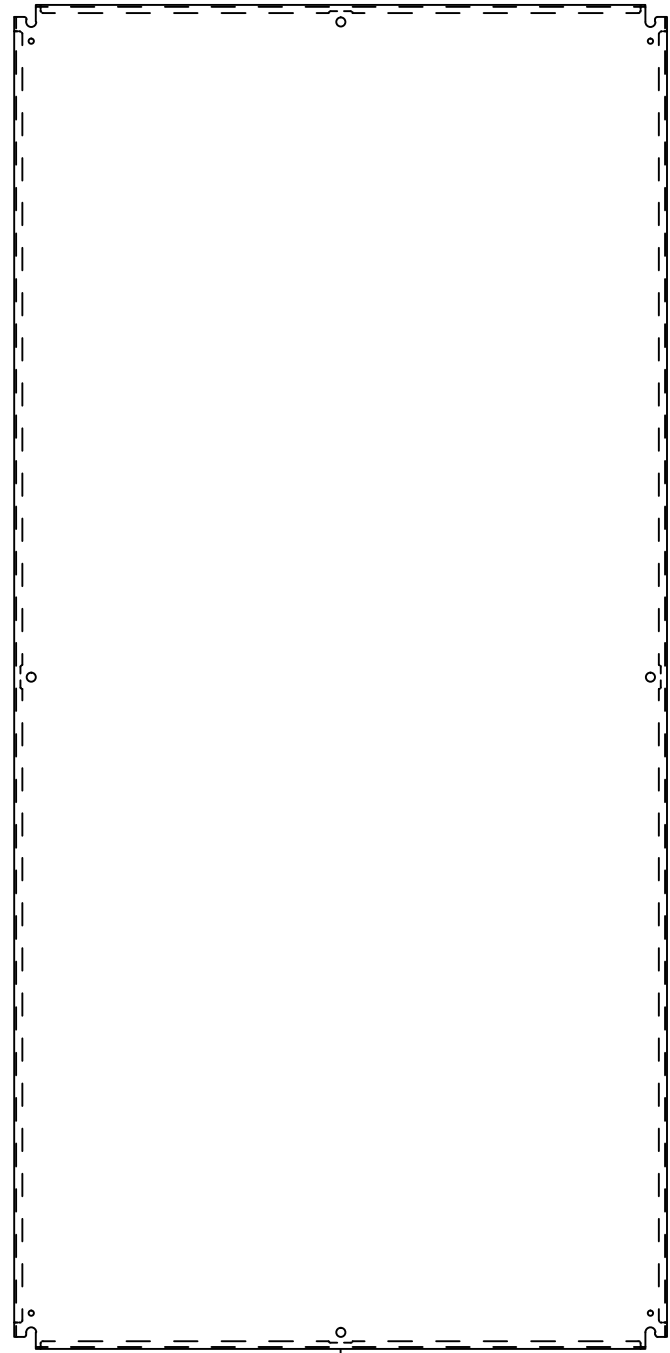

FRONT

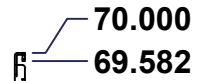

RIGHT

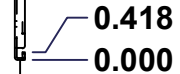

No.	Revisions	Date	By/Par

Isometric View

Tél: (450) 979-4373 Fax: (450) 979-4626 www.exmweb.com		Flatness Aplatissement Max 3.0mm Projection
Customer Client	Date	
Drawn By Dessiné Par: BoxCad	Date: 23-Jan-07	
Material Matière	See Part List	
Color Couleur	See Part List	Finish Fini: See Part List
Description: 881 SP - Inner Panel		Detail Rev.
Part Number Numéro Pièce: 881 SP7236G		Rev. 1 0

Qty	Part Number	Rev	Description	Material	Color	Finish
1	881 SP7236G-P	0	881 SP - Inner Panel Part	12 Ga Galvanized	Unpainted	Galvanized

Parts List

This drawing is confidential and must not be reproduced or used without the consent of EXM

Ce dessin est confidentiel et ne doit pas être reproduit ou utilisé sans le consentement de EXM

Table 1			FRONT VIEW
CUT-OUT	XDIM	YDIM	DESCRIPTION
1	17.000	0.875	MTG STUD HOLE (RND Ø0.500)
2	0.875	35.000	MTG STUD HOLE (RND Ø0.500)
3	33.125	35.000	MTG STUD HOLE (RND Ø0.500)
4	17.000	69.125	MTG STUD HOLE (RND Ø0.500)
5	0.875	1.875	GROUND HOLE (RND Ø0.290)
6	33.125	1.875	GROUND HOLE (RND Ø0.290)
7	0.875	68.125	GROUND HOLE (RND Ø0.290)
8	33.125	68.125	GROUND HOLE (RND Ø0.290)

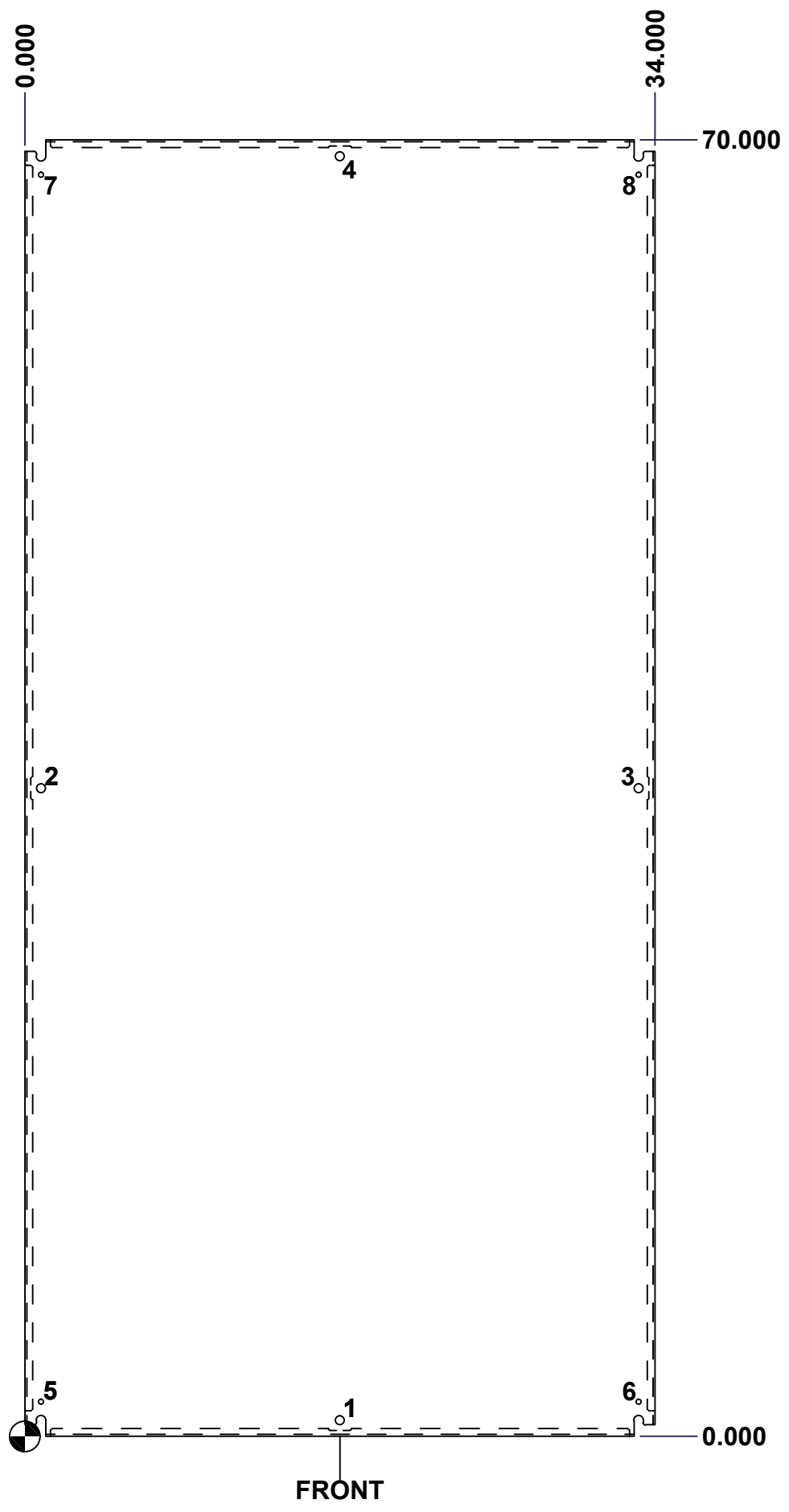

All knockouts are actual size / Les disques défonçables sont grandeur réel

No.	Revisions	Date	By/Par

Isometric View

		Tél: (450) 979-4373 Fax: (450) 979-4626 www.exmweb.com		Flatness Aplatissement Max 3.0mm	
Customer Client		Date		Projection 	
Drawn By Dessiné Par BoxCad		Date 23-Jan-07		Material Matière See Part List	
Color Couleur See Part List		Finish Fini See Part List		Description 881 SP - Inner Panel	
Part Number Numéro Pièce 881 SP7236G		Rev. 0		Detail Rev. 2	