

This drawing is confidential and must not be reproduced or used without the consent of EXM

Ce dessin est confidentiel et ne doit pas être reproduit ou utilisé sans le consentement de EXM

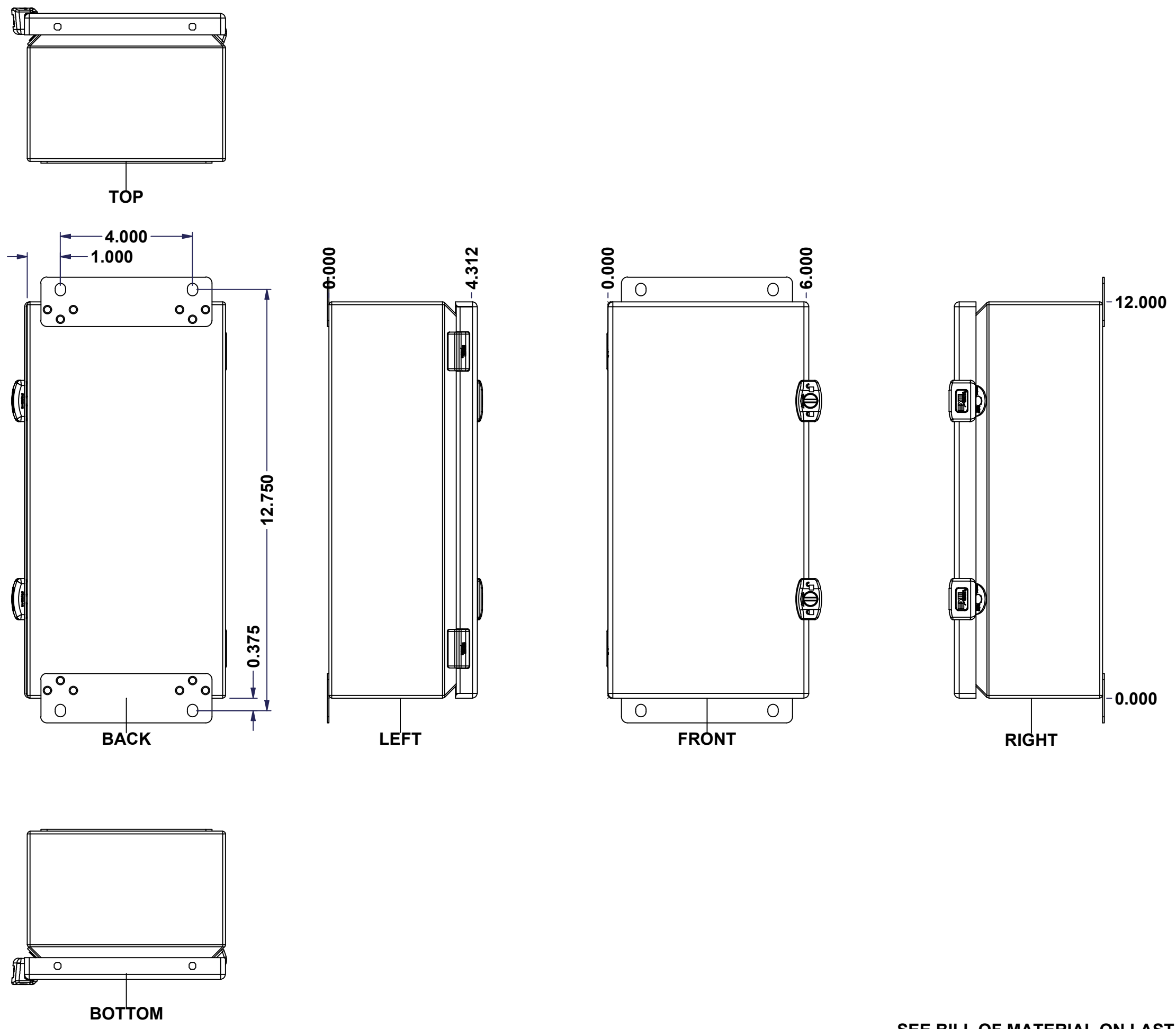

No.	Revisions	Date	By/Par

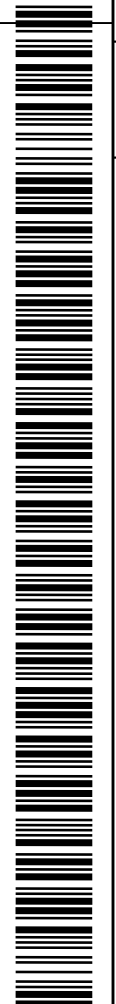
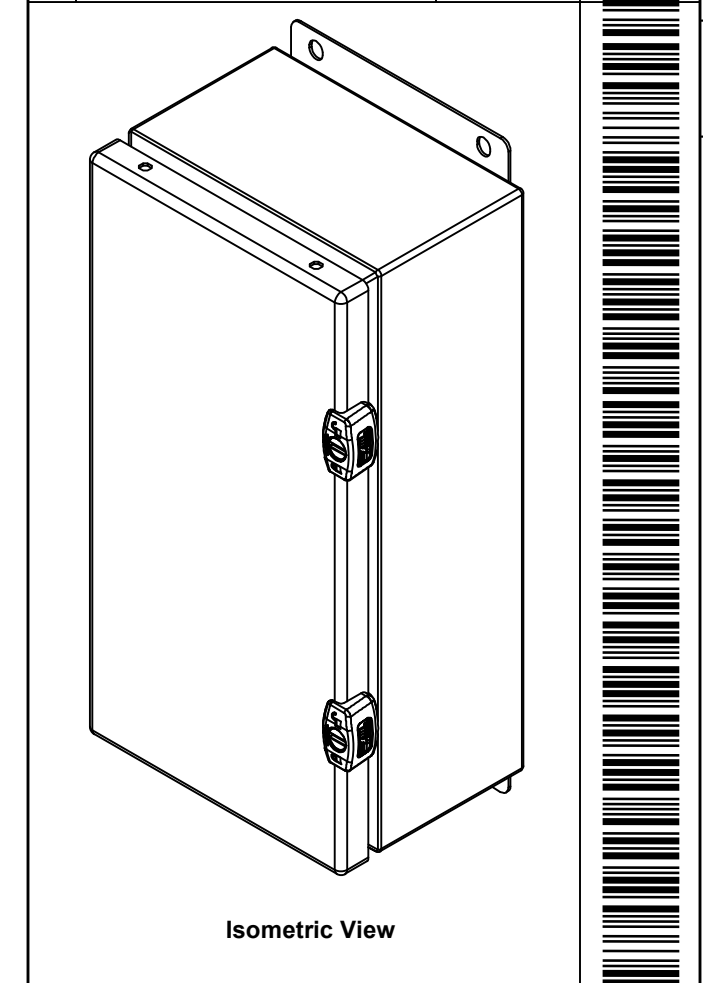

Tél: (450) 979-4373 Fax: (450) 979-4626 www.exmweb.com		Flatness Aplatissement
		Max 3.0mm
Customer Client Drawn By / Dessiné Par: BoxCad: BoxCad Material / Matière: 16 Ga Cold Rolled A1008 CS Type B (1.4mm)		Projection
Date		Date
Date 08-Mar-23		Date 08-Mar-23
Color / Couleur: Asa-61 Grey		Finish / Fini: Smooth
Description: 5412ESCH 12" x 6" x 4" Assembly		Detail Rev.
Part Number / Numéro Pièce: 5412ESCH120604NOIP		Rev. 1
SEE BILL OF MATERIAL ON LAST PAGE		0
		9

This drawing is confidential and must not be reproduced or used without the consent of EXM

Ce dessin est confidentiel et ne doit pas être reproduit ou utilisé sans le consentement de EXM

NOTE	
ITEM	DESCRIPTION
1	NEMA 4/12 Enclosure
2	C/W Standard ground standoffs on box and cover
3	W/O Standard door stiffener
4	W/O Inner panel
5	C/W Standard inner panel mounting standoffs

No.	Revisions	Date	By/Par

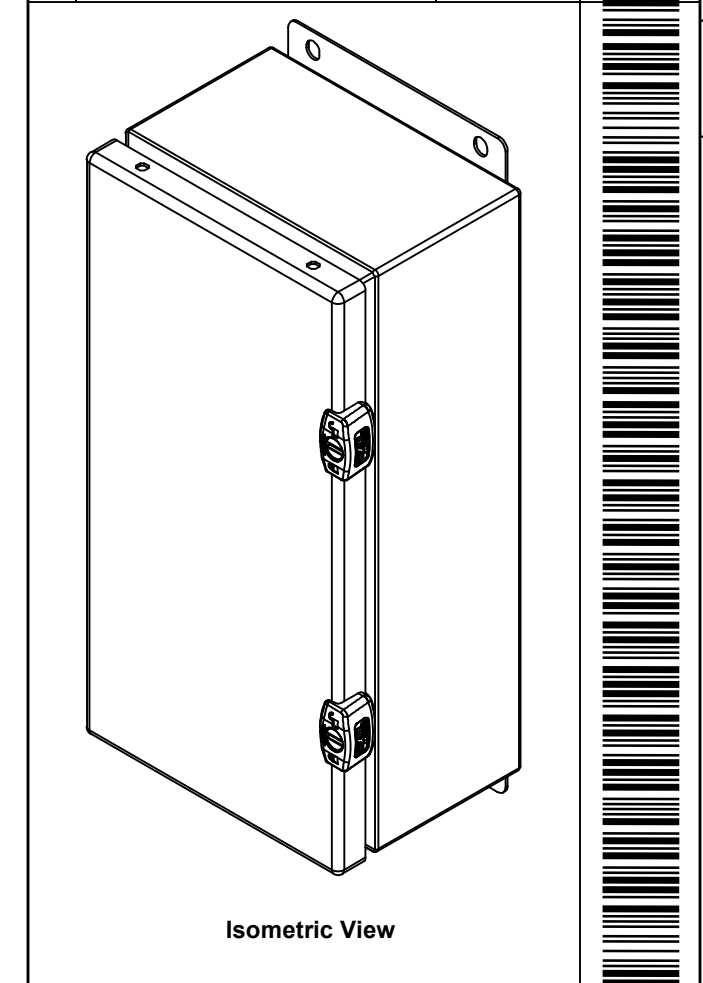

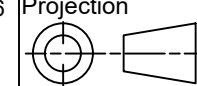
 Tél: (450) 979-4373 Fax: (450) 979-4626 www.exmweb.com	Flatness Aplatissement Max 3.0mm
	Projection 
Customer Client	Date
Drawn By Dessiné Par BoxCad: BoxCad	Date 08-Mar-23
Material Matière 16 Ga Cold Rolled A1008 CS Type B (1.4mm)	
Color Couleur Asa-61 Grey	Finish Fini Smooth
Description 5412ESCH 12" x 6" x 4" Assembly	
Part Number Numéro Pièce 5412ESCH120604NOIP	Rev. 2 0 9

PACKING		
ITEM	QTY	DESCRIPTION
STK-E-04315	1	CARTON 5412 ESCH120604
Plastic bag	1	To protect cover surface and inside gasket
Packaging label	1	White label with product number
STK-S-01100	1	ESCH EXM SQUARE STICKER

Qty	Part Number	Rev	Description
1	STK-K-02910	3	5412 ESCH Accessory Kit
1	5412ESCH120604NOIPC	0	5412ESCH 12" x 6" Cover
1	5412ESCH120604NOIPB	0	5412ESCH 12" x 6" x 4" Body
2	STK-Q-08100	1	M5 Nylon Insert Lock Nut
2	STK-Q-10249	0	M5 Sealing Washer
Parts List			

This drawing is confidential and must not be reproduced or used without the consent of EXM

Ce dessin est confidentiel et ne doit pas être reproduit ou utilisé sans le consentement de EXM

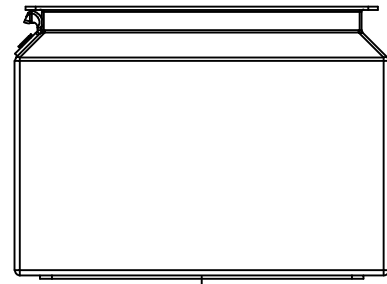

TOP

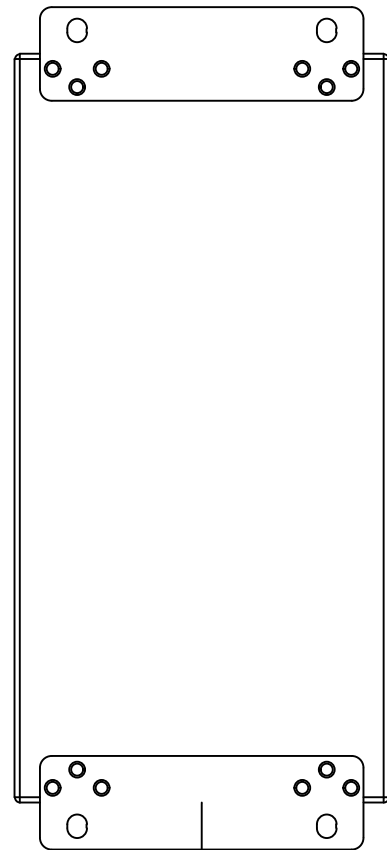

BACK

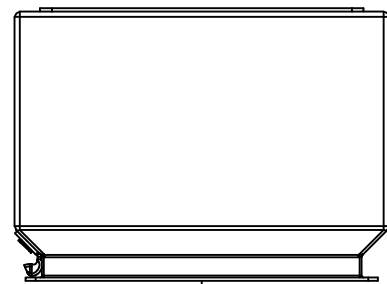

BOTTOM

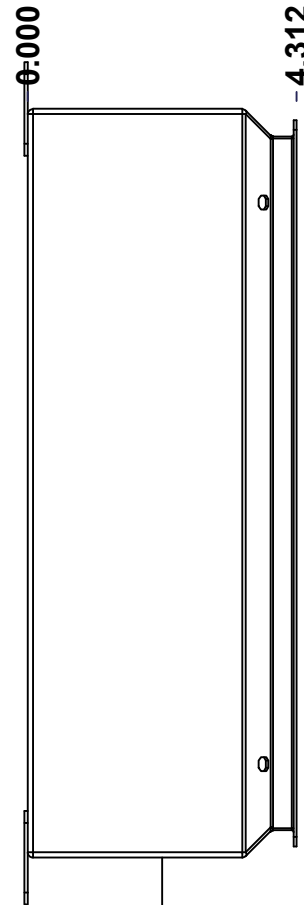

LEFT

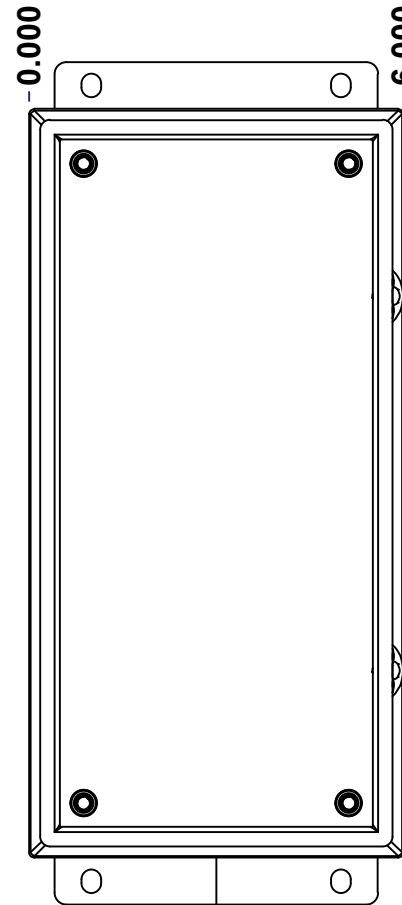

FRONT

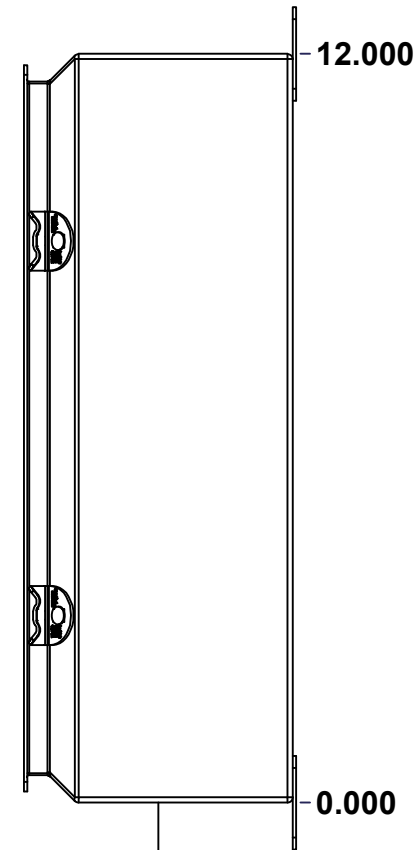

RIGHT

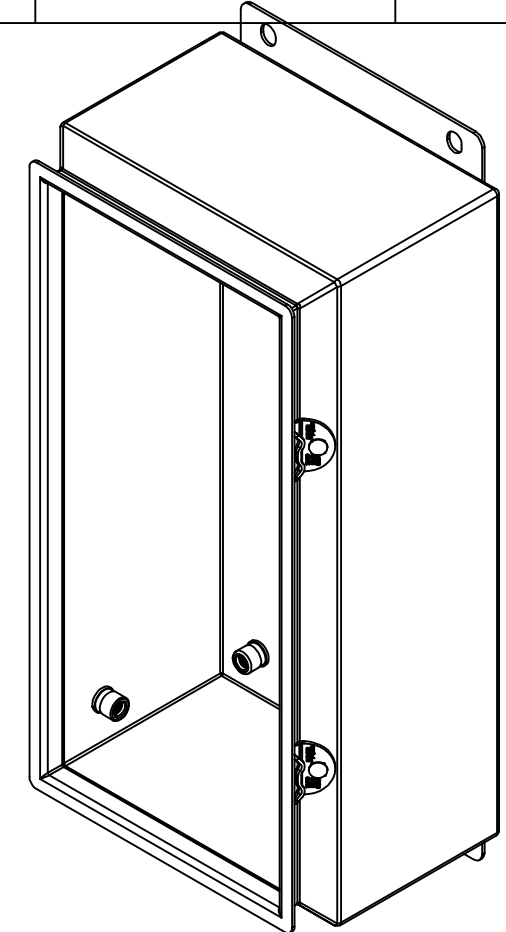

Isometric View

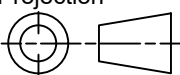

No.	Revisions	Date	By/Par

 Tél: (450) 979-4373 Fax: (450) 979-4626 www.exmweb.com		Flatness Aplatissement Max 3.0mm Projection 
Customer Client	Date	
Drawn By Dessiné Par	BoxCad: BoxCad	Date 08-Mar-23
Material Matière	16 Ga Cold Rolled A1008 CS Type B (1.4mm)	
Color Couleur	Asa-61 Grey	Finish Fini Smooth
Description	Detail Rev.	
5412ESCH 12" x 6" x 4" Body		
Part Number Numéro Pièce	Rev. 0	3 9

SEE BILL OF MATERIAL ON LAST PAGE

5412ESCH120604NOIPB

This drawing is confidential and must not be reproduced or used without the consent of EXM

Ce dessin est confidentiel et ne doit pas être reproduit ou utilisé sans le consentement de EXM

STANDARD FEATURES ARE NOT LISTED IN THIS HOLE TABLE			
HOLE TABLE - LEFT VIEW (CUSTOM FEATURE ONLY)			
CUT-OUT	XDIM	YDIM	DESCRIPTION
1	2.625	0.875	STANDOFF M6 x 10mm (Inside)

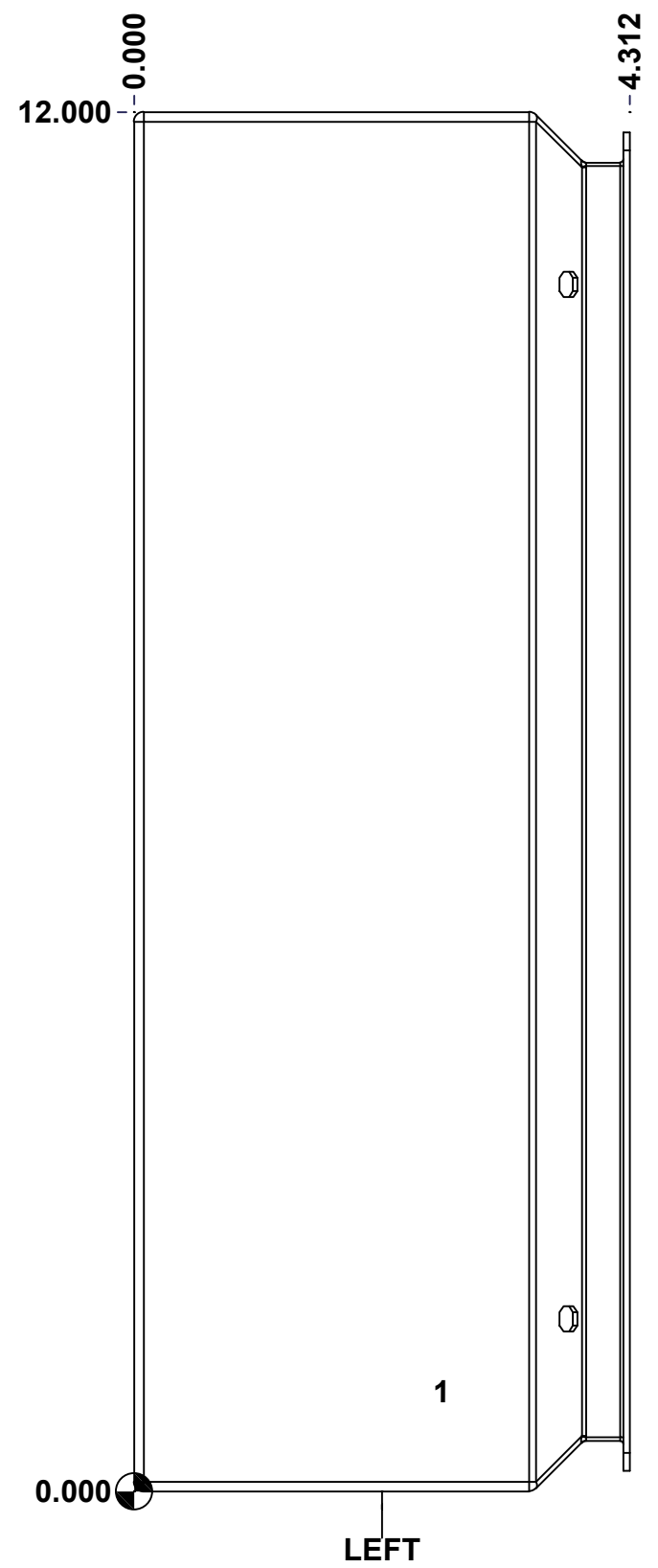

	Description	Status
	5412ESCH 12" x 6" x 4" Body	(NULL)
	Part Number Numéro Pièce	Rev.
	5412ESCH120604NOIPB	0 / 4 9

This drawing is confidential and must not be reproduced or used without the consent of EXM

Ce dessin est confidentiel et ne doit pas être reproduit ou utilisé sans le consentement de EXM

STANDARD FEATURES ARE NOT LISTED IN THIS HOLE TABLE

HOLE TABLE - BACK VIEW (CUSTOM FEATURE ONLY)

CUT-OUT	XDIM	YDIM	DESCRIPTION
1	0.875	0.875	IP STANDOFF M6 x 10mm (Inside)
2	0.875	11.125	IP STANDOFF M6 x 10mm (Inside)
3	5.125	11.125	IP STANDOFF M6 x 10mm (Inside)
4	5.125	0.875	IP STANDOFF M6 x 10mm (Inside)

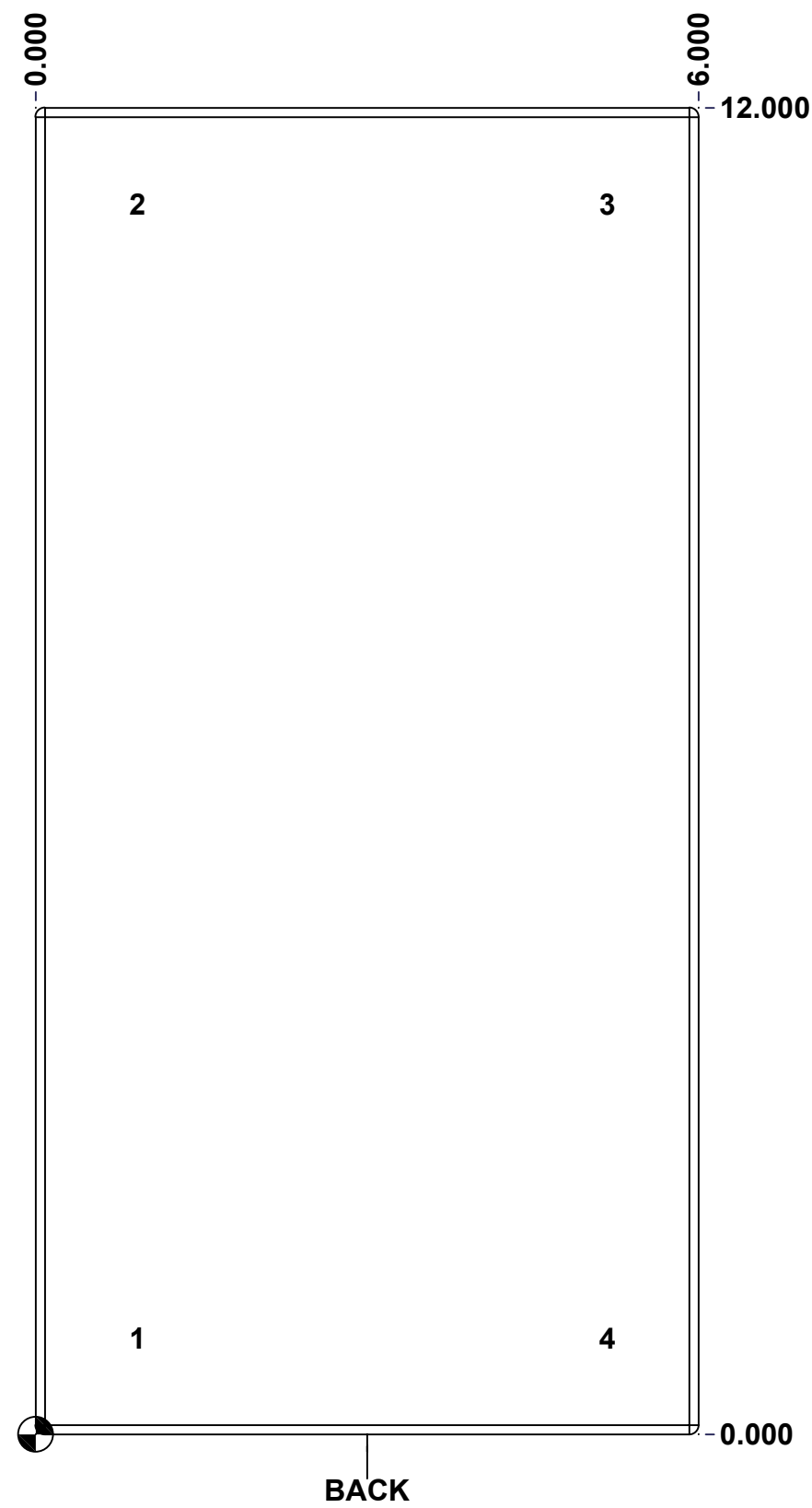

	Description	Status
	5412ESCH 12" x 6" x 4" Body	(NULL)
	Part Number Numéro Pièce	Rev.
	5412ESCH120604NOIPB	0 / 5 / 9

This drawing is confidential and must not be reproduced or used without the consent of EXM

Ce dessin est confidentiel et ne doit pas être reproduit ou utilisé sans le consentement de EXM

No.	Revisions	Date	By/Par

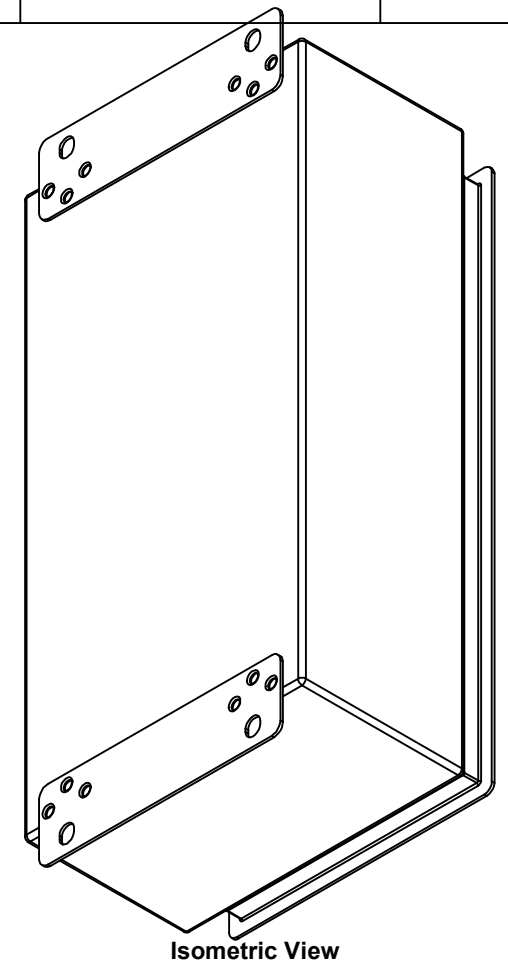

Isometric View



 Tél: (450) 979-4373
 Fax: (450) 979-4626
www.exmweb.com

Flatness / Aplatissement: Max 3.0mm
 Projection: 

Customer Client	Date
Drawn By / Dessiné Par: BoxCad: BoxCad	Date: 08-Mar-23

Material / Matière: 16 Ga Cold Rolled A1008 CS Type B (1.4mm)

Color / Couleur: Asa-61 Grey Finish / Fini: Smooth

Description: 5412ESCH 12" x 6" x 4" Body Detail Rev.

Part Number / Numéro Pièce: **5412ESCH120604NOIPB** Rev. 0

2	5412ESCH120604NOIPM F-P	0	5412ESCH Mounting Feet (5.181")
1	5412ESCH120604NOIPB-P	0	5412ESCH 12" x 6" x 4" Body Part
1	STK-P-02400S	0	Powder Paint (Asa-61 Grey / Smooth)
2	STK-A-70469	6	5412 ESSMCH - Stainless Steel 316 Body Catch Assembly
2	STK-Q-08100	1	M5 Nylon Insert Lock Nut
5	STK-Q-08350	5	Standoff M6 x 10mm
Qty	Part Number	Rev	Description
Parts List			

This drawing is confidential and must not be reproduced or used without the consent of EXM

Ce dessin est confidentiel et ne doit pas être reproduit ou utilisé sans le consentement de EXM

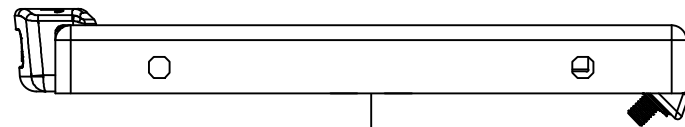

TOP

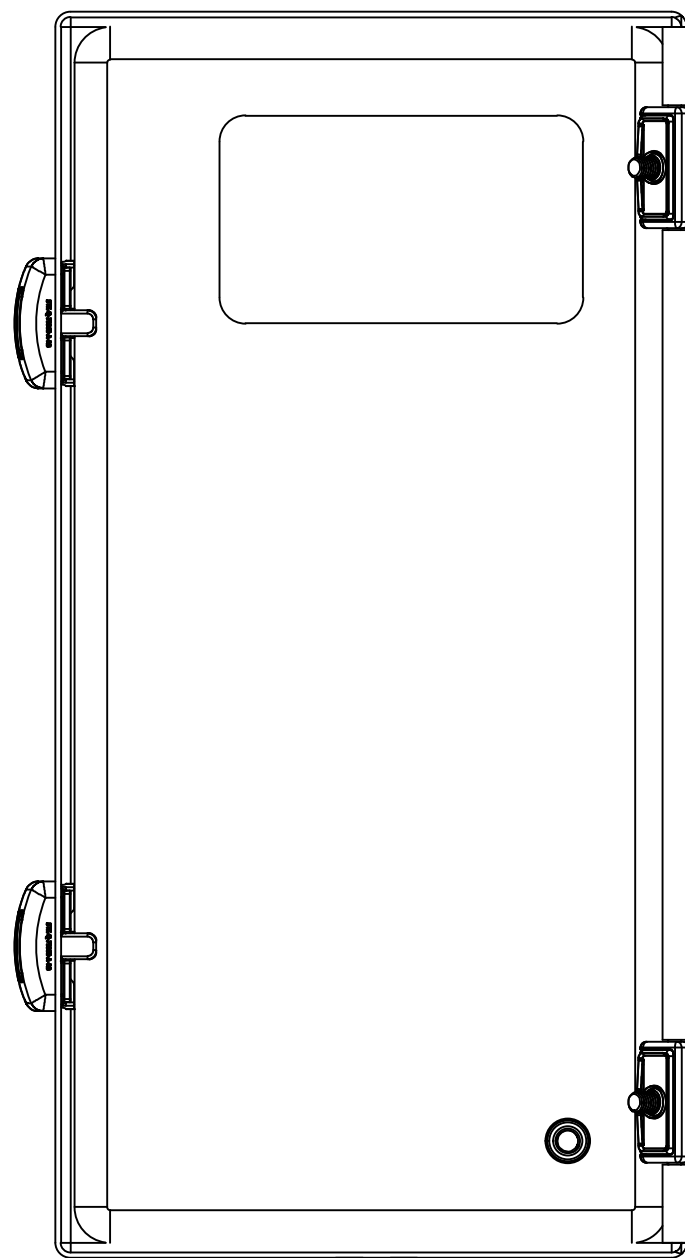

BACK

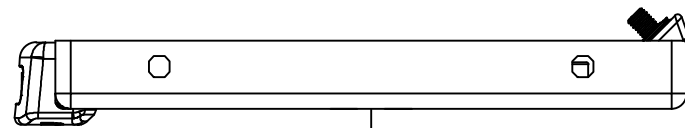

BOTTOM

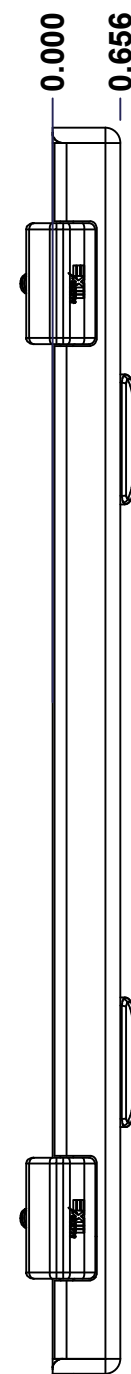

LEFT

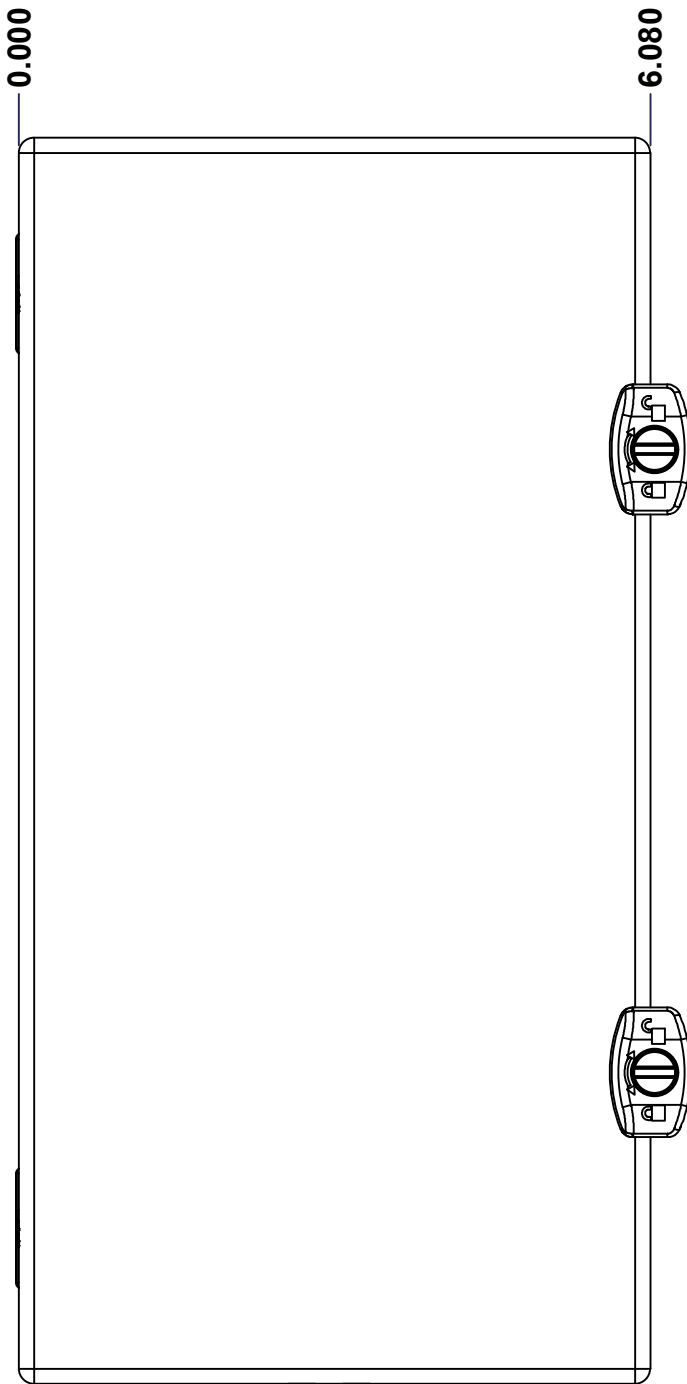

FRONT

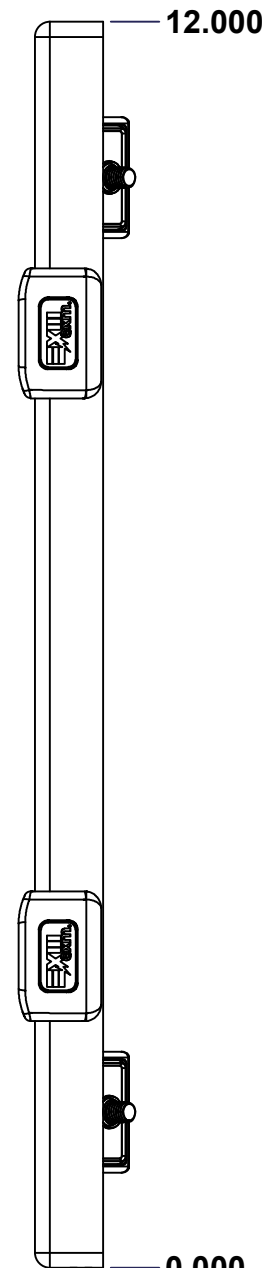

RIGHT

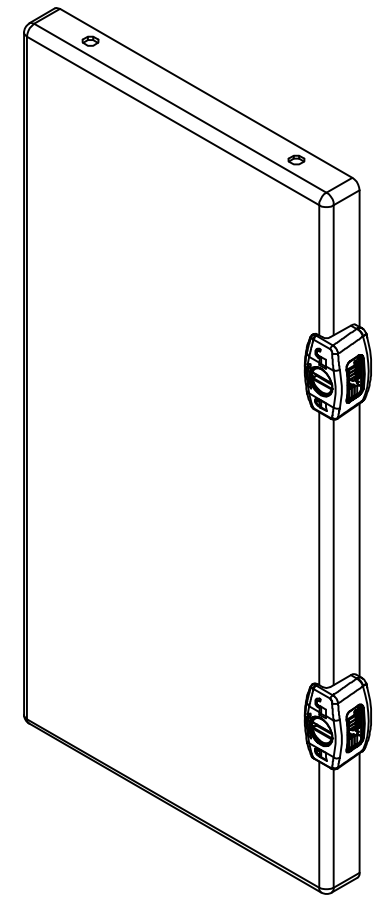

Isometric View

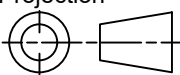

No.	Revisions	Date	By/Par

 Tél: (450) 979-4373 Fax: (450) 979-4626 www.exmweb.com		Flatness Aplatissement Max 3.0mm Projection 
Customer Client	Date	
Drawn By Dessiné Par	BoxCad: BoxCad	Date 08-Mar-23
Material Matière	16 Ga Cold Rolled A1008 CS Type B (1.4mm)	
Color Couleur	Asa-61 Grey	Finish Fini Smooth
Description 5412ESCH 12" x 6" Cover		Detail Rev.
Part Number Numéro Pièce	Rev. 0	7 9

SEE BILL OF MATERIAL ON LAST PAGE

5412ESCH120604NOIPC

This drawing is confidential and must not be reproduced or used without the consent of EXM

Ce dessin est confidentiel et ne doit pas être reproduit ou utilisé sans le consentement de EXM

STANDARD FEATURES ARE NOT LISTED IN THIS HOLE TABLE

HOLE TABLE - FRONT VIEW (CUSTOM FEATURE ONLY)

CUT-OUT	XDIM	YDIM	DESCRIPTION
1	2.750	10.000	LABEL_EXM
2	1.145	1.125	STANDOFF M6 x 10mm (Inside)
3	6.080	9.000	LOCK 880 SCQ2MS @ 0.0°
4	6.080	3.000	LOCK 880 SCQ2MS @ 0.0°

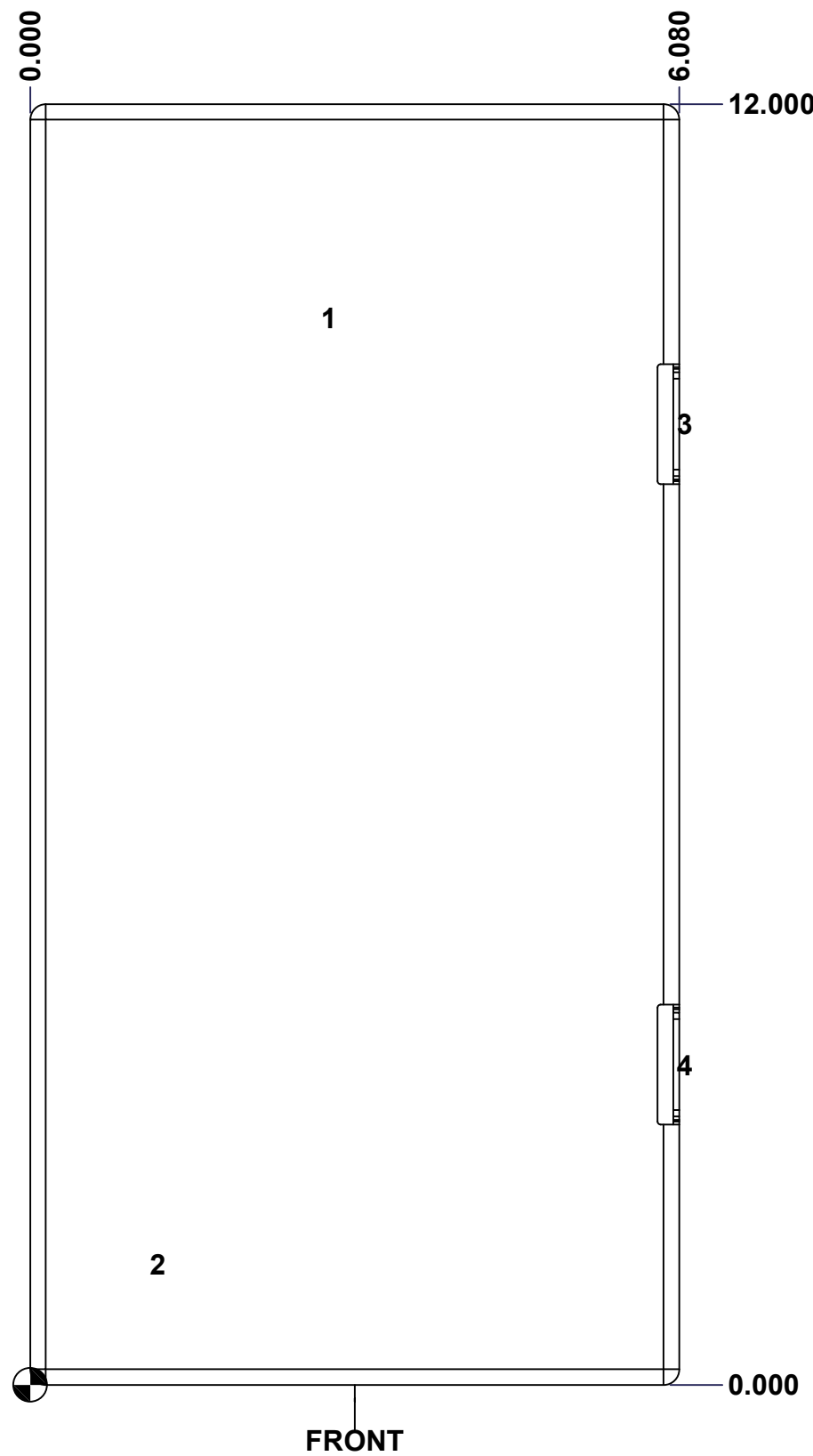

	Description	Status
	5412ESCH 12" x 6" Cover	(NULL)
	Part Number Numéro Pièce	Rev.
	5412ESCH120604NOIPC	0 / 8 / 9

This drawing is confidential and must not be reproduced or used without the consent of EXM

Ce dessin est confidentiel et ne doit pas être reproduit ou utilisé sans le consentement de EXM

No.	Revisions	Date	By/Par

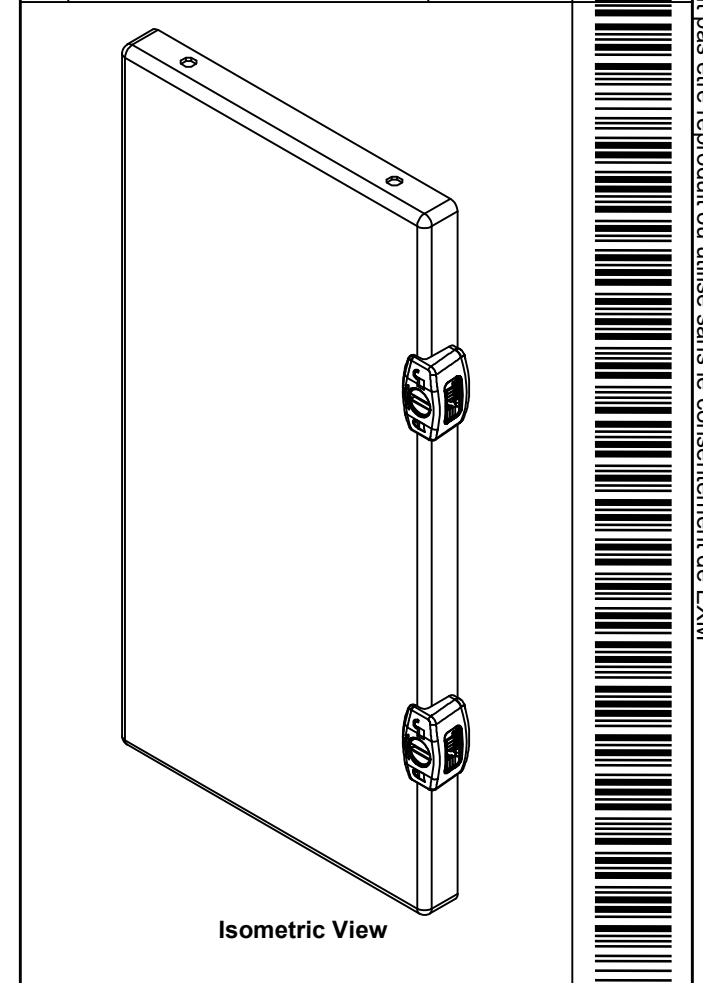

 Tél: (450) 979-4373
 Fax: (450) 979-4626
www.exmweb.com

Flatness / Aplatissement: Max 3.0mm
 Projection: 

Customer Client: _____ Date: _____
 Drawn By / Dessiné Par: BoxCad: BoxCad Date: 08-Mar-23

Material / Matière: 16 Ga Cold Rolled A1008 CS Type B (1.4mm)

Color / Couleur: Asa-61 Grey Finish / Fini: Smooth

Description: 5412ESCH 12" x 6" Cover
 Detail Rev.:

Part Number / Numéro Pièce: **5412ESCH120604NOIPC**
 Rev. 0

Qty	Part Number	Rev	Description
1	5412ESCH120604NOIPG	0	5412ESCH 12" x 6" Gasket
1	STK-Q-08350	5	Standoff M6 x 10mm
1	STK-S-00100	0	3.5" x 2" Silver Milar Flexcon Sticker
1	STK-P-02400S	0	Powder Paint (Asa-61 Grey / Smooth)
1	5412ESCH120604NOIPC-P	0	5412ESCH 12" x 6" Cover Part
2	STK-A-33033	4	5412 ESMCH Hinge
2	880SCQ2MS	3	5412 ESMCH - External Lock Assy - Slot Lock
Parts List			

Rev. 9