

This drawing is confidential and must not be reproduced or used without the consent of EXM

Ce dessin est confidentiel et ne doit pas être reproduit ou utilisé sans le consentement de EXM

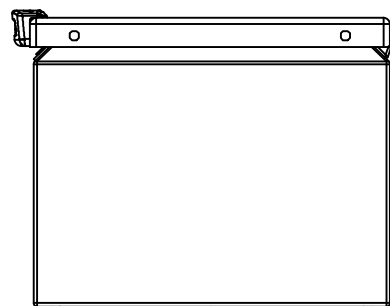

TOP

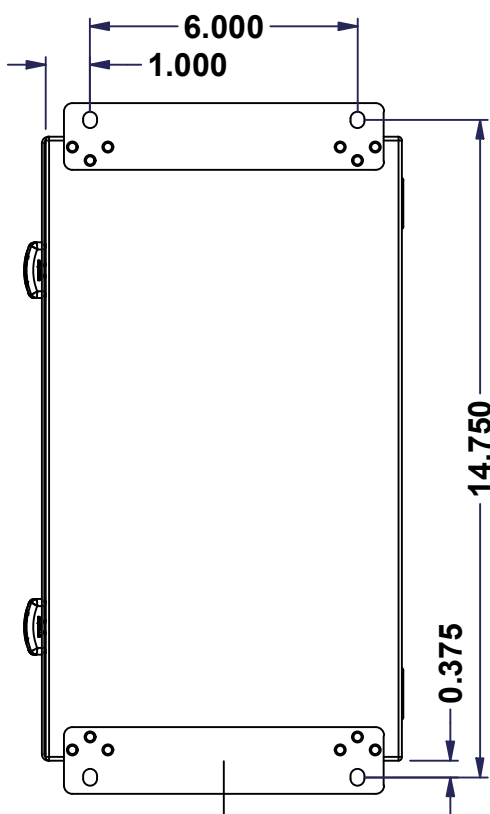

BACK

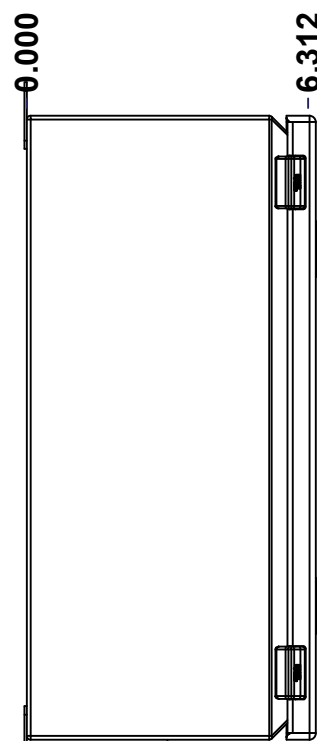

LEFT

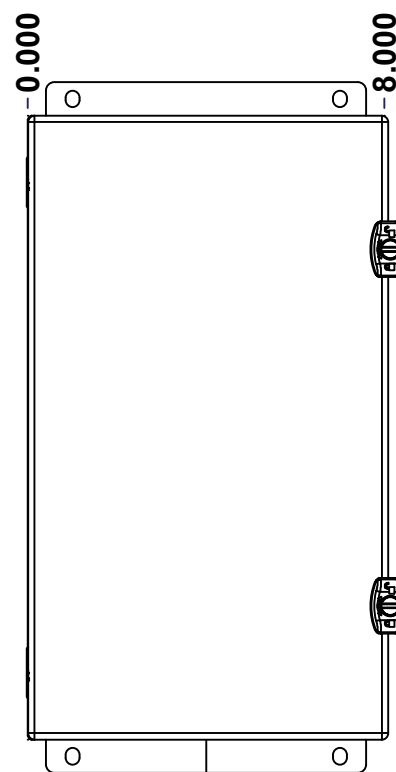

FRONT

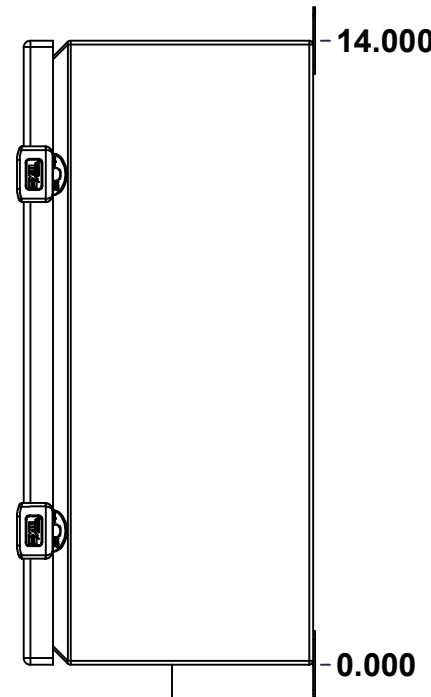

RIGHT

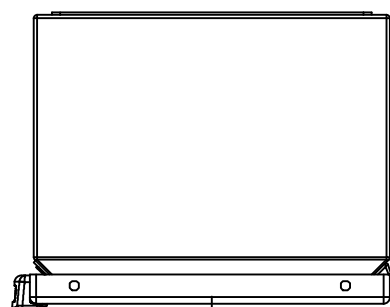

BOTTOM

No.	Revisions	Date	By/Par

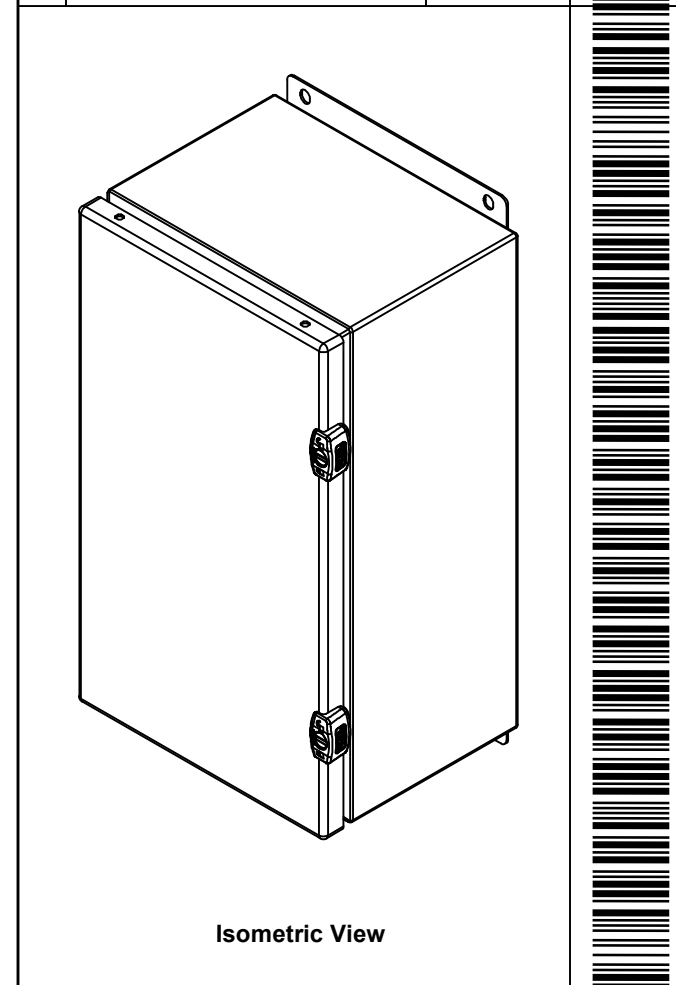

Isometric View

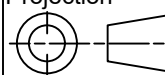

 Tél: (450) 979-4373 Fax: (450) 979-4626 <a href="http://www.exmweb.com">www.exmweb.com</a>		Flatness Aplatissement Max 3.0mm Projection 
Customer Client		Date
Drawn By Dessiné Par	BoxCad: BoxCad	Date 08-Mar-23
Material Matière	16 Ga Cold Rolled A1008 CS Type B (1.4mm)	
Color Couleur	Asa-61 Grey	Finish Fini Smooth
Description 5412ESCH 14" x 8" x 6" Assembly		Detail Rev.
Part Number Numéro Pièce	5412ESCH140806NOIP	Rev. 1 0

SEE BILL OF MATERIAL ON LAST PAGE

This drawing is confidential and must not be reproduced or used without the consent of EXM

Ce dessin est confidentiel et ne doit pas être reproduit ou utilisé sans le consentement de EXM

NOTE	
ITEM	DESCRIPTION
1	NEMA 4/12 Enclosure
2	C/W Standard ground standoffs on box and cover
3	W/O Standard door stiffener
4	W/O Inner panel
5	C/W Standard inner panel mounting standoffs

No.	Revisions	Date	By/Par

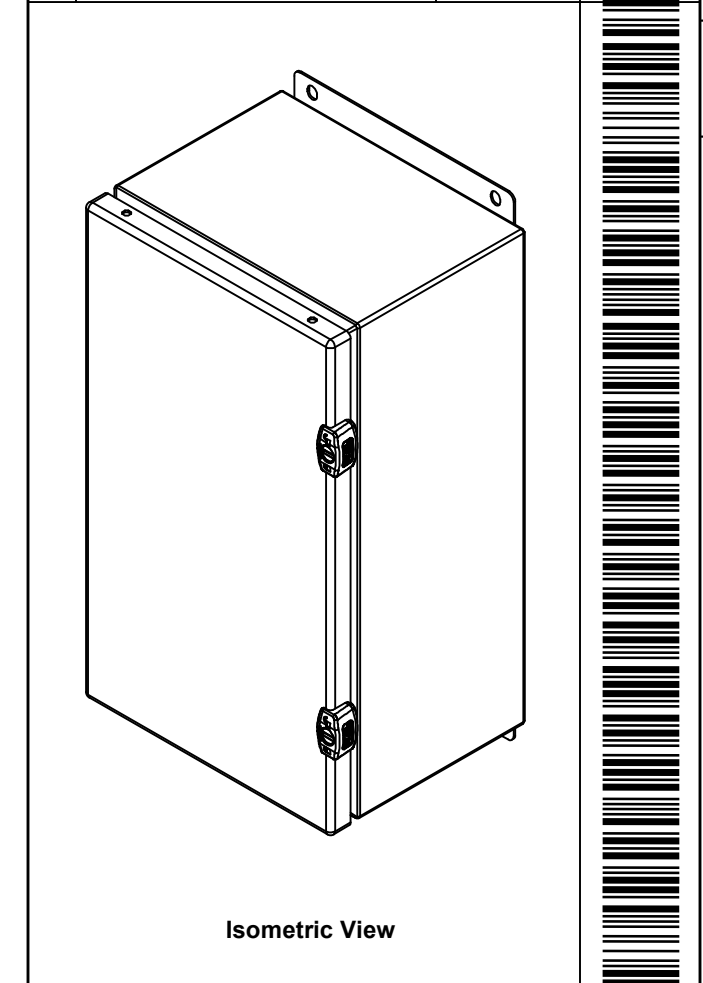

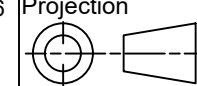
 Tél: (450) 979-4373 Fax: (450) 979-4626 <a href="http://www.exmweb.com">www.exmweb.com</a>		Flatness Aplatissement Max 3.0mm Projection 
Customer Client	Date	
Drawn By Dessiné Par	BoxCad: BoxCad	Date 08-Mar-23
Material Matière	16 Ga Cold Rolled A1008 CS Type B (1.4mm)	
Color Couleur	Asa-61 Grey	Finish Fini Smooth
Description		Detail Rev.
5412ESCH 14" x 8" x 6" Assembly		
Part Number Numéro Pièce	<b>5412ESCH140806NOIP</b>	Rev. 2 <b>0</b> 9

PACKING		
ITEM	QTY	DESCRIPTION
STK-E-04321	1	CARTON 5412 ESCH140806
Plastic bag	1	To protect cover surface and inside gasket
Packaging label	1	White label with product number
STK-S-01100	1	ESCH EXM SQUARE STICKER

1	STK-K-02910	3	5412 ESCH Accessory Kit
1	5412ESCH140806NOIPC	0	5412ESCH 14" x 8" Cover
1	5412ESCH140806NOIPB	0	5412ESCH 14" x 8" x 6" Body
2	STK-Q-08100	1	M5 Nylon Insert Lock Nut
2	STK-Q-10249	0	M5 Sealing Washer
Qty	Part Number	Rev	Description
Parts List			

This drawing is confidential and must not be reproduced or used without the consent of EXM

Ce dessin est confidentiel et ne doit pas être reproduit ou utilisé sans le consentement de EXM

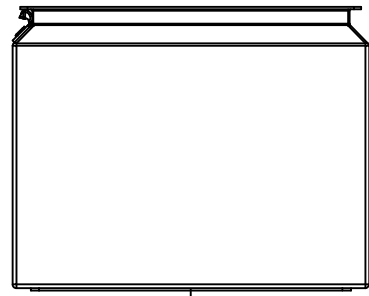

TOP

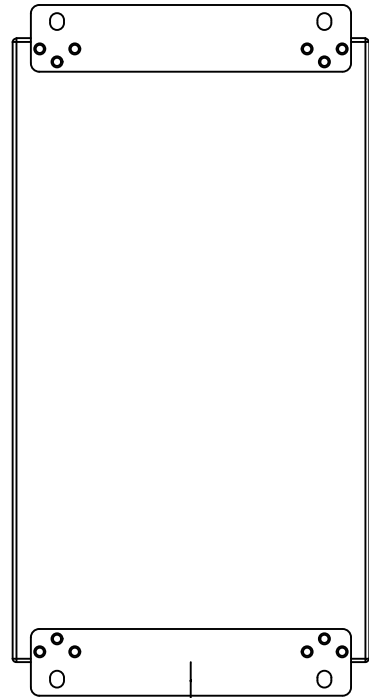

BACK

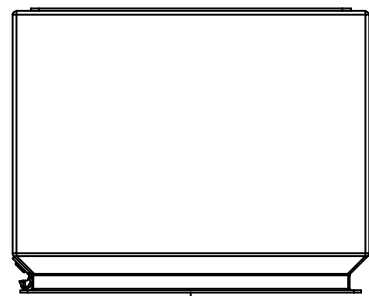

BOTTOM

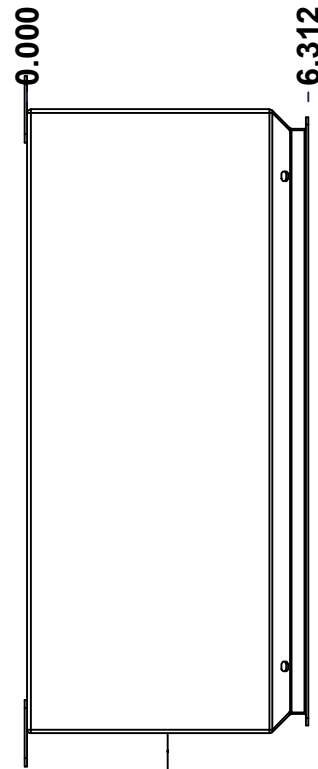

LEFT

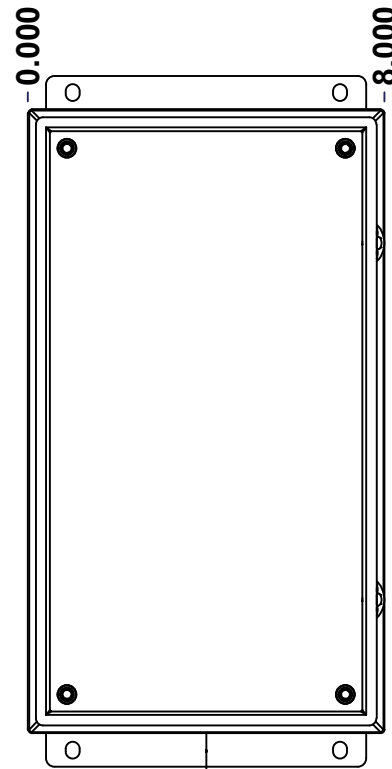

FRONT

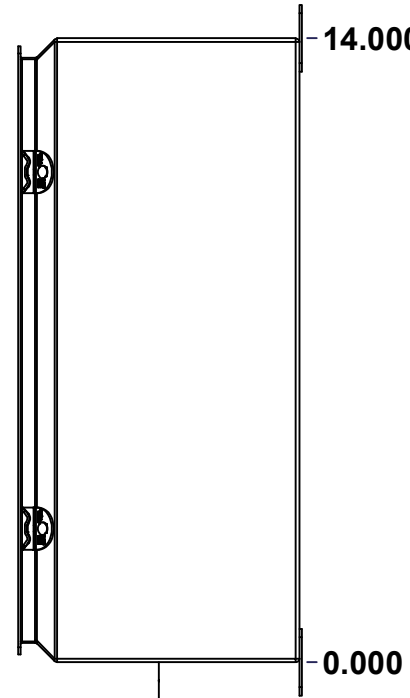

RIGHT

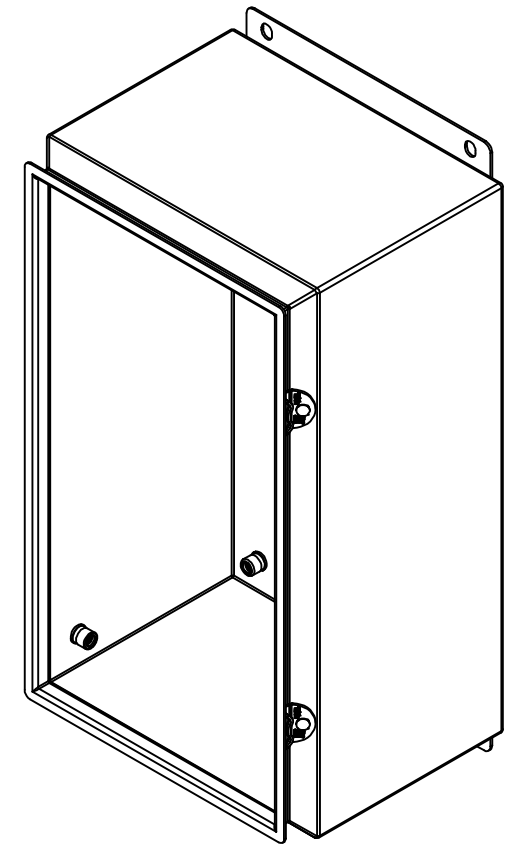

Isometric View

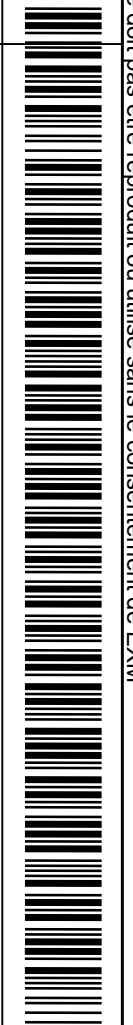

No.	Revisions	Date	By/Par

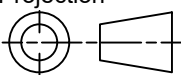
 Tél: (450) 979-4373 Fax: (450) 979-4626 <a href="http://www.exmweb.com">www.exmweb.com</a>		Flatness Aplatissement Max 3.0mm Projection 
Customer Client	Date	
Drawn By Dessiné Par	BoxCad: BoxCad	Date 08-Mar-23
Material Matière	16 Ga Cold Rolled A1008 CS Type B (1.4mm)	
Color Couleur	Asa-61 Grey	Finish Fini Smooth
Description	Detail Rev.	
5412ESCH 14" x 8" x 6" Body		
Part Number Numéro Pièce	Rev.	3
5412ESCH140806NOIPB	0	9

SEE BILL OF MATERIAL ON LAST PAGE

This drawing is confidential and must not be reproduced or used without the consent of EXM

Ce dessin est confidentiel et ne doit pas être reproduit ou utilisé sans le consentement de EXM

STANDARD FEATURES ARE NOT LISTED IN THIS HOLE TABLE			
HOLE TABLE - LEFT VIEW (CUSTOM FEATURE ONLY)			
CUT-OUT	XDIM	YDIM	DESCRIPTION
1	4.625	0.875	STANDOFF M6 x 10mm (Inside)

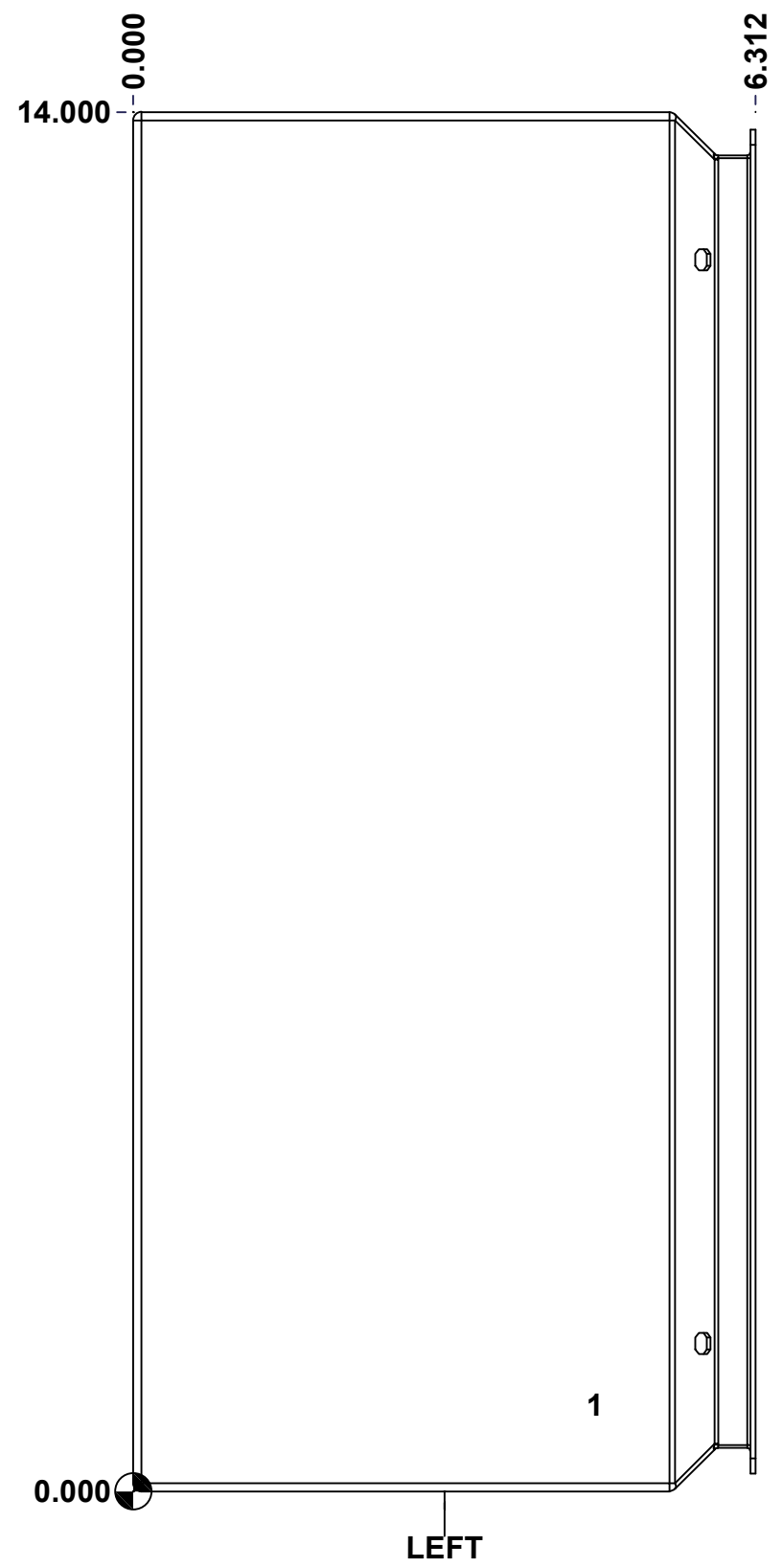

	Description	Status
	5412ESCH 14" x 8" x 6" Body	(NULL)
	Part Number Numéro Pièce	Rev.
	<b>5412ESCH140806NOIPB</b>	<b>0</b> / 4 9

This drawing is confidential and must not be reproduced or used without the consent of EXM

Ce dessin est confidentiel et ne doit pas être reproduit ou utilisé sans le consentement de EXM

**STANDARD FEATURES ARE NOT LISTED IN THIS HOLE TABLE**

**HOLE TABLE - BACK VIEW (CUSTOM FEATURE ONLY)**

CUT-OUT	XDIM	YDIM	DESCRIPTION
1	0.875	0.875	IP STANDOFF M6 x 10mm (Inside)
2	0.875	13.125	IP STANDOFF M6 x 10mm (Inside)
3	7.125	13.125	IP STANDOFF M6 x 10mm (Inside)
4	7.125	0.875	IP STANDOFF M6 x 10mm (Inside)

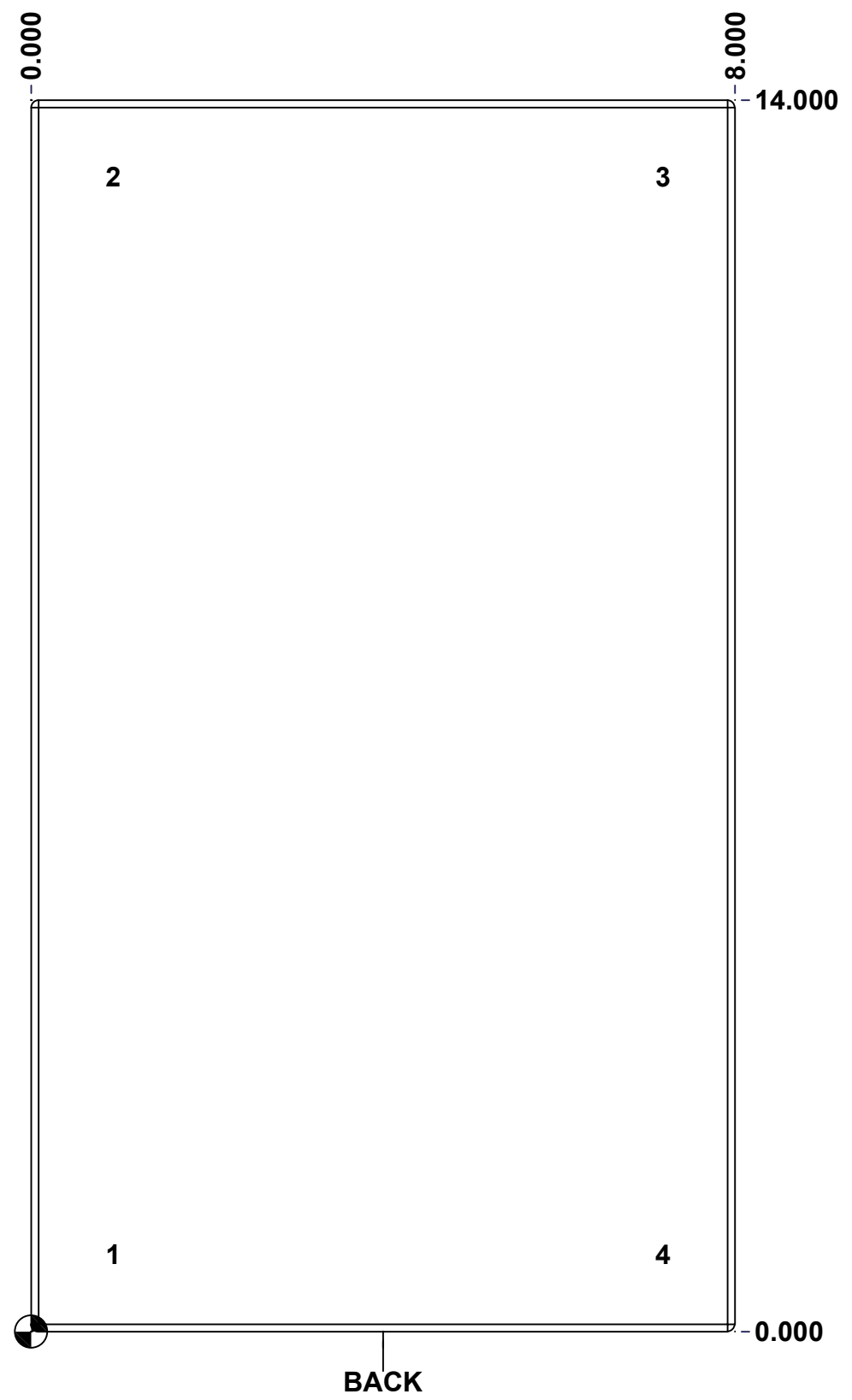

	Description	Status
	5412ESCH 14" x 8" x 6" Body	(NULL)
	Part Number Numéro Pièce	Rev.
	<b>5412ESCH140806NOIPB</b>	<b>0</b> / 5 9

This drawing is confidential and must not be reproduced or used without the consent of EXM

Ce dessin est confidentiel et ne doit pas être reproduit ou utilisé sans le consentement de EXM

No.	Revisions	Date	By/Par

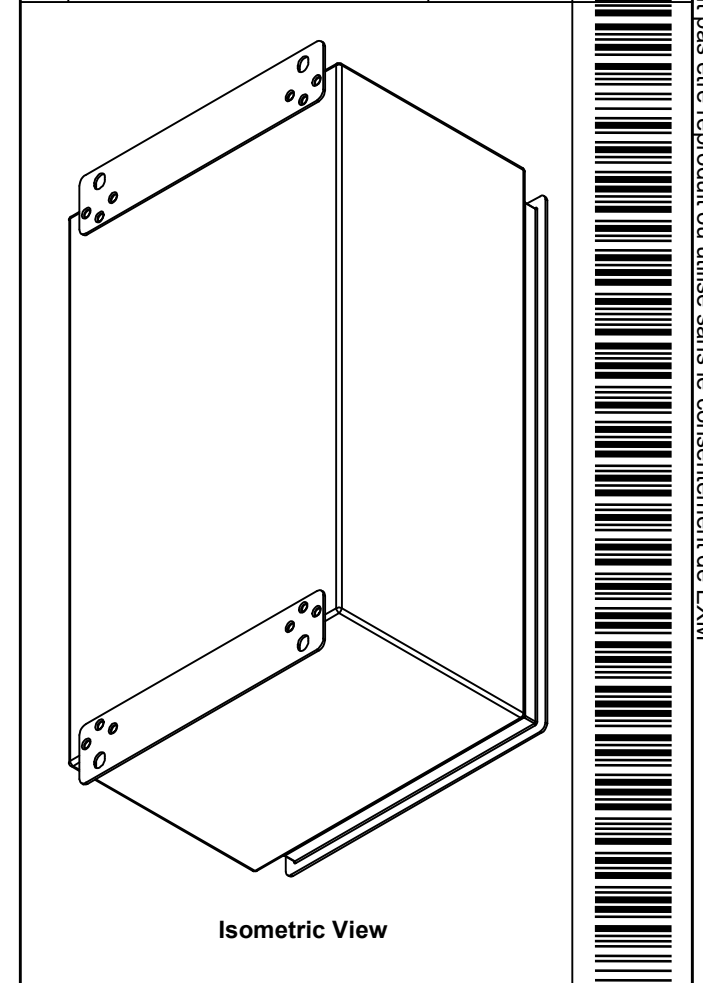

 Tél: (450) 979-4373  
 Fax: (450) 979-4626  
[www.exmweb.com](http://www.exmweb.com)

Flatness / Aplatissement: Max 3.0mm  
 Projection: 

Customer Client	Date
Drawn By / Dessiné Par: BoxCad: BoxCad	Date: 08-Mar-23
Material / Matière: 16 Ga Cold Rolled A1008 CS Type B (1.4mm)	

Color / Couleur: Asa-61 Grey	Finish / Fini: Smooth
Description: 5412ESCH 14" x 8" x 6" Body	
Detail Rev.	

Qty	Part Number	Rev	Description
2	STK-Q-71305-08	0	5412ESCH Mounting Feet ( 7.181" )
1	5412ESCH140806NOIPB-P	0	5412ESCH 14" x 8" x 6" Body Part
1	STK-P-02400S	0	Powder Paint (Asa-61 Grey / Smooth)
2	STK-A-70469	6	5412 ESSMCH - Stainless Steel 316 Body Catch Assembly
2	STK-Q-08100	1	M5 Nylon Insert Lock Nut
5	STK-Q-08350	5	Standoff M6 x 10mm
Parts List			

Part Number / Numéro Pièce: <b>5412ESCH140806NOIPB</b>	Rev. <b>0</b>	6 / 9
--	---------------	-------

This drawing is confidential and must not be reproduced or used without the consent of EXM

Ce dessin est confidentiel et ne doit pas être reproduit ou utilisé sans le consentement de EXM

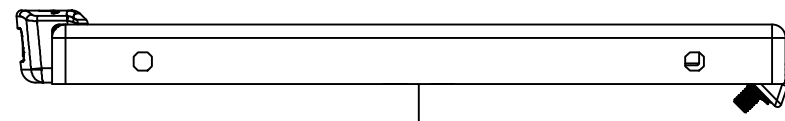

TOP

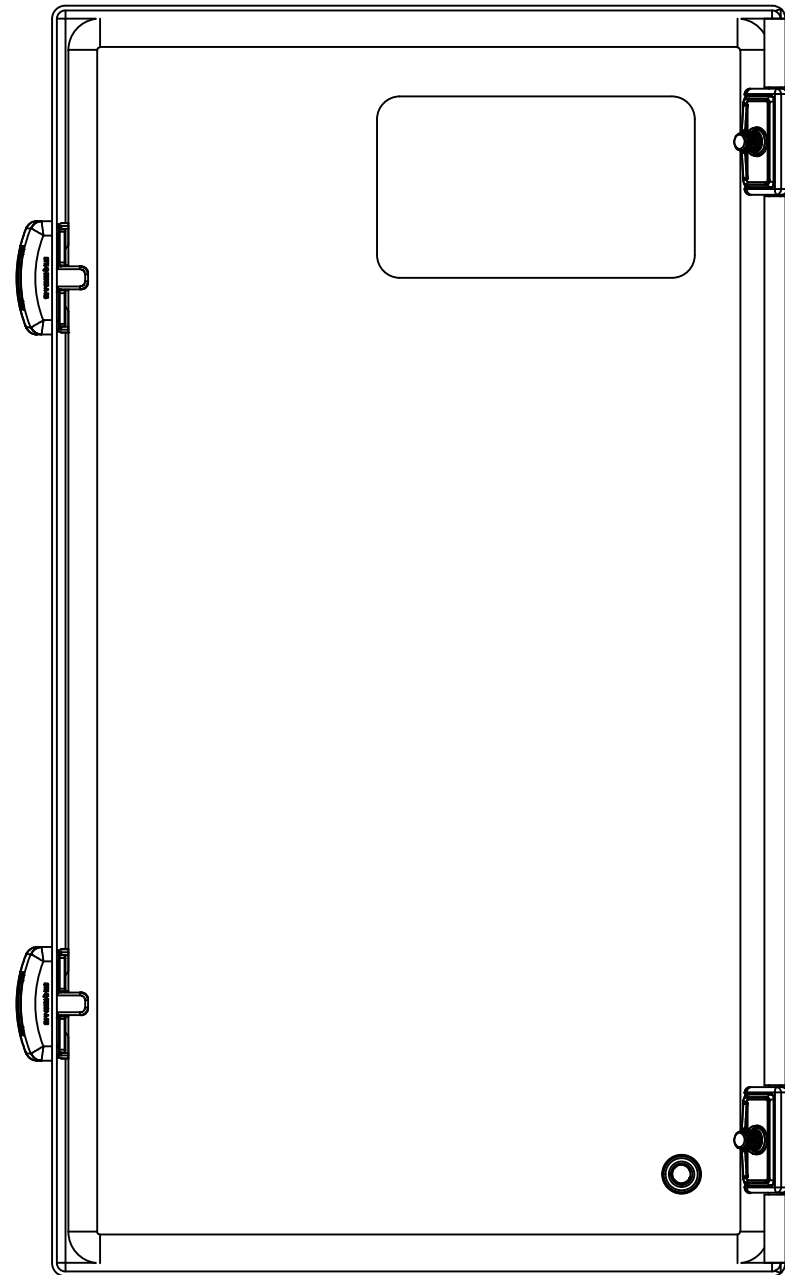

BACK

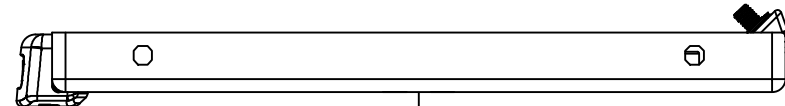

BOTTOM

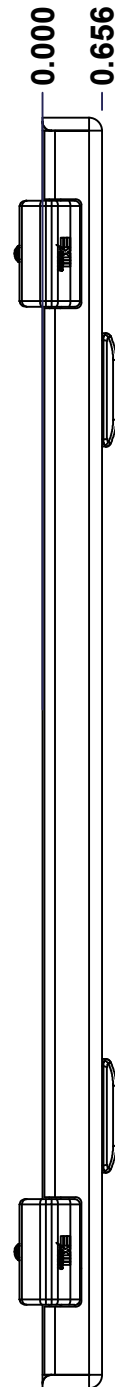

LEFT

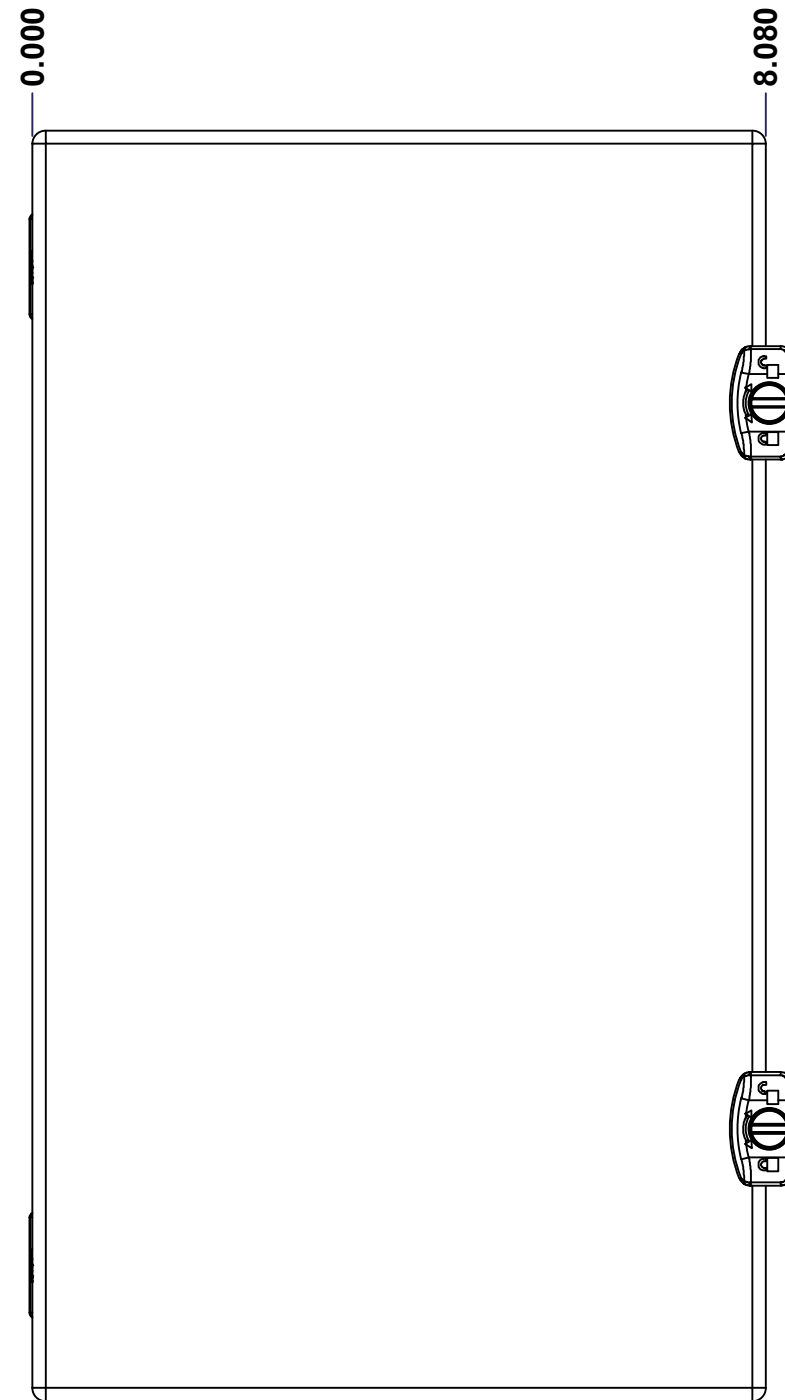

FRONT

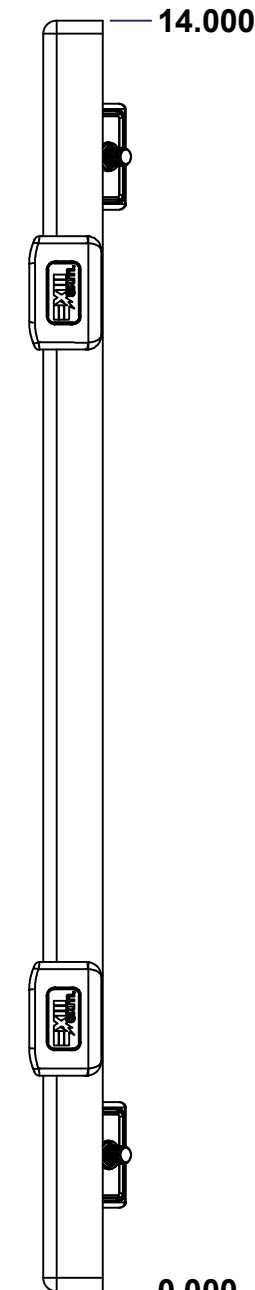

RIGHT

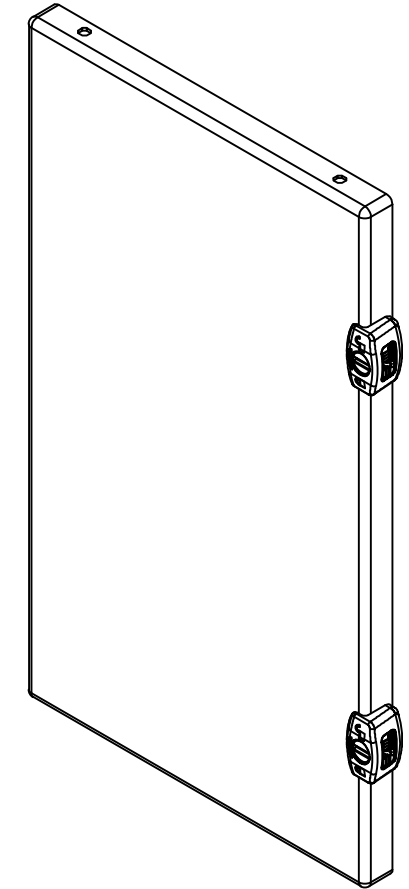

Isometric View

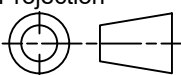

No.	Revisions	Date	By/Par

 Tél: (450) 979-4373 Fax: (450) 979-4626 <a href="http://www.exmweb.com">www.exmweb.com</a>		Flatness Aplatissement Max 3.0mm Projection 
Customer Client	Date	Date
Drawn By Dessiné Par	BoxCad: BoxCad	Date 08-Mar-23
Material Matière	16 Ga Cold Rolled A1008 CS Type B (1.4mm)	
Color Couleur	Asa-61 Grey	Finish Fini Smooth
Description	Detail Rev.	
5412ESCH 14" x 8" Cover		
Part Number Numéro Pièce	Rev.	7
5412ESCH140806NOIPC	0	9

SEE BILL OF MATERIAL ON LAST PAGE

This drawing is confidential and must not be reproduced or used without the consent of EXM

Ce dessin est confidentiel et ne doit pas être reproduit ou utilisé sans le consentement de EXM

**STANDARD FEATURES ARE NOT LISTED IN THIS HOLE TABLE**

**HOLE TABLE - FRONT VIEW (CUSTOM FEATURE ONLY)**

CUT-OUT	XDIM	YDIM	DESCRIPTION
1	2.750	12.000	LABEL_EXM
2	1.145	1.125	STANDOFF M6 x 10mm (Inside)
3	8.080	3.000	LOCK 880 SCQ2MS @ 0.0°
4	8.080	11.000	LOCK 880 SCQ2MS @ 0.0°

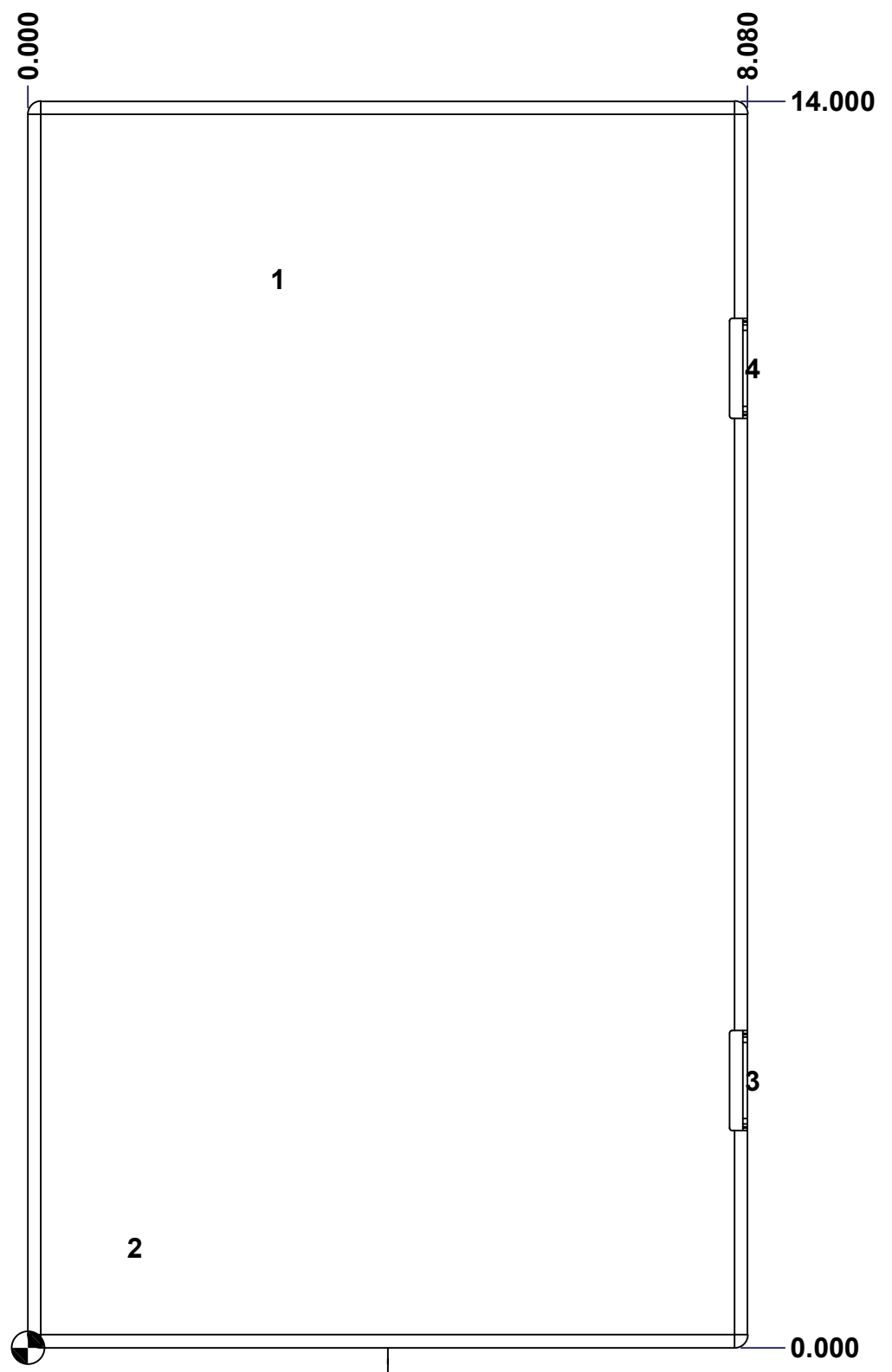

FRONT

	Description	Status
	5412ESCH 14" x 8" Cover	(NULL)
	Part Number Numéro Pièce	Rev.
	<b>5412ESCH140806NOIPC</b>	<b>0</b> / 8 / 9



This drawing is confidential and must not be reproduced or used without the consent of EXM

Ce dessin est confidentiel et ne doit pas être reproduit ou utilisé sans le consentement de EXM

No.	Revisions	Date	By/Par

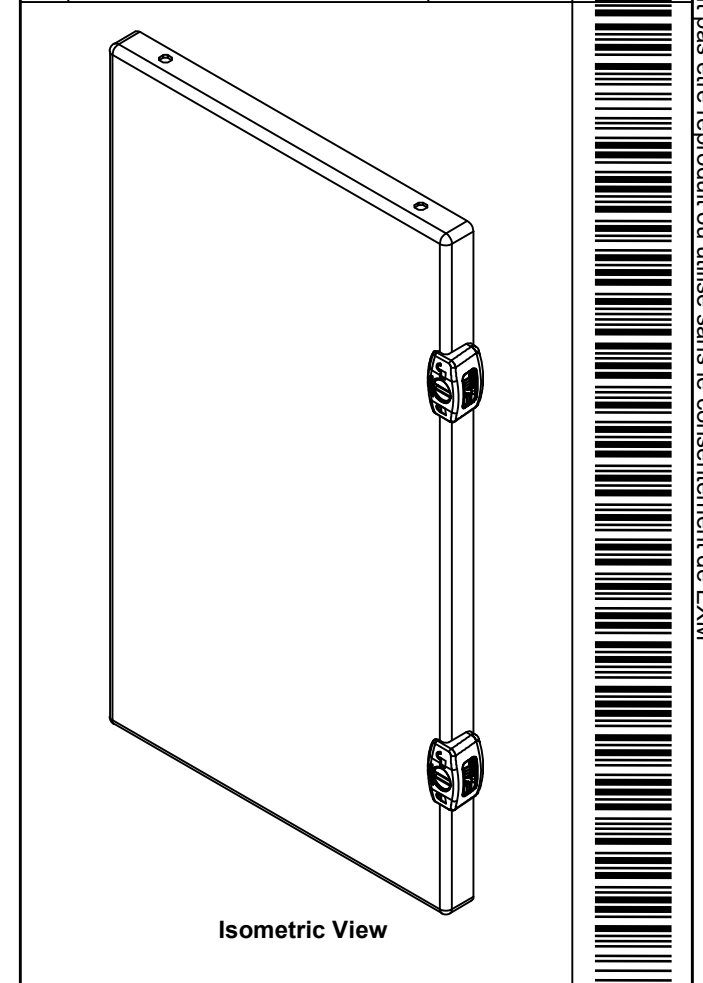

 Tél: (450) 979-4373  
 Fax: (450) 979-4626  
[www.exmweb.com](http://www.exmweb.com)

Flatness / Aplatissement: Max 3.0mm  
 Projection: 

Customer Client: \_\_\_\_\_ Date: \_\_\_\_\_  
 Drawn By / Dessiné Par: BoxCad: BoxCad Date: 08-Mar-23

Material / Matière: 16 Ga Cold Rolled A1008 CS Type B (1.4mm)

Color / Couleur: Asa-61 Grey Finish / Fini: Smooth

Description: 5412ESCH 14" x 8" Cover  
 Detail Rev.:

Part Number / Numéro Pièce: **5412ESCH140806NOIPC**  
 Rev. 0

Qty	Part Number	Rev	Description
1	5412ESCH140806NOIPG	0	5412ESCH 14" x 8" Gasket
1	STK-Q-08350	5	Standoff M6 x 10mm
1	STK-S-00100	0	3.5" x 2" Silver Milar Flexcon Sticker
1	STK-P-02400S	0	Powder Paint (Asa-61 Grey / Smooth)
1	5412ESCH140806NOIPC-P	0	5412ESCH 14" x 8" Cover Part
2	STK-A-33033	4	5412 ESMCH Hinge
2	880SCQ2MS	3	5412 ESMCH - External Lock Assy - Slot Lock
Parts List			

Rev. 9