

This drawing is confidential and must not be reproduced or used without the consent of EXM

Ce dessin est confidentiel et ne doit pas être reproduit ou utilisé sans le consentement de EXM

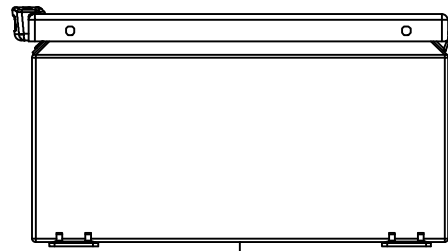

TOP

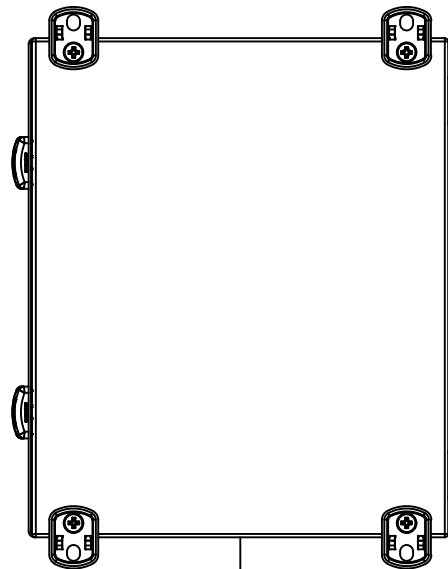

BACK

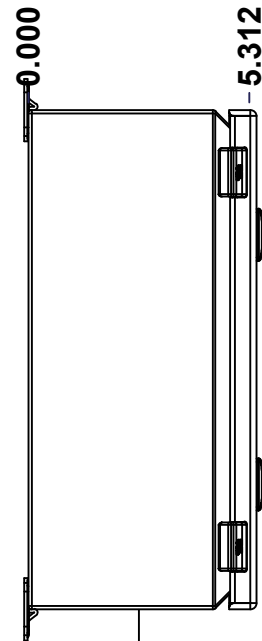

LEFT

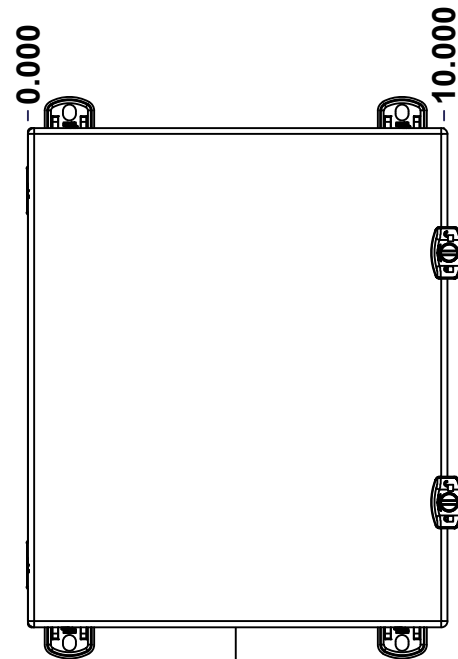

FRONT

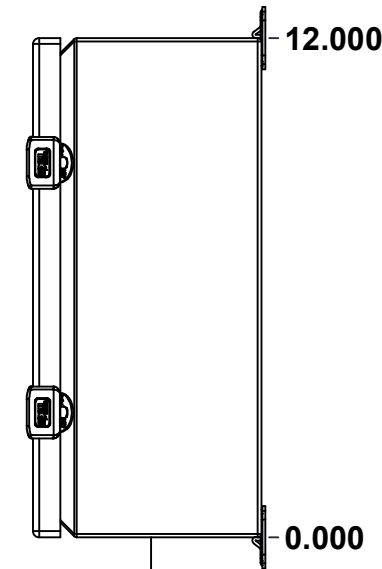

RIGHT

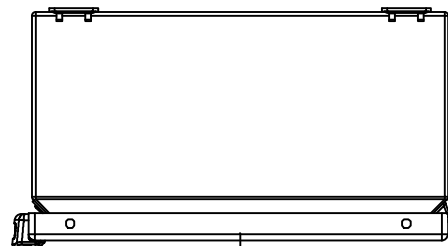

BOTTOM

No.	Revisions	Date	By/Par

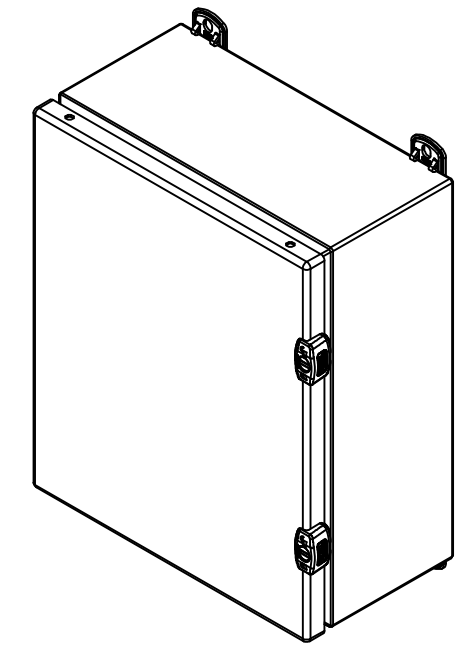

Isometric View



Tél: (450) 979-4373  
 Fax: (450) 979-4626  
[www.exmweb.com](http://www.exmweb.com)

Flatness  
Aplatissement

Max 3.0mm

Projection

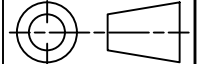

Customer Client	Date
Drawn By Dessiné Par BoxCad: BoxCad	Date 20-Nov-13
Material Matière 16 Ga Cold Rolled A1008 CS Type B (1.4mm)	

Color Couleur Light Grey RAL7035	Finish Fini Rough Textured
-------------------------------------	-------------------------------

Description 5412ESCHB 12" x 10" x 5" Assembly	Detail Rev.
--	-------------

Part Number Numéro Pièce 5412ESCHB121005	Rev. 0	1 9
---	--------	--------

SEE BILL OF MATERIAL ON LAST PAGE

This drawing is confidential and must not be reproduced or used without the consent of EXM

Ce dessin est confidentiel et ne doit pas être reproduit ou utilisé sans le consentement de EXM

NOTE	
ITEM	DESCRIPTION
1	NEMA 4/12 Enclosure
2	C/W Standard ground standoffs on box and cover
3	W/O Standard door stiffener
4	C/W Standard inner panel (Included)
5	C/W Standard inner panel mounting standoffs

No.	Revisions	Date	By/Par

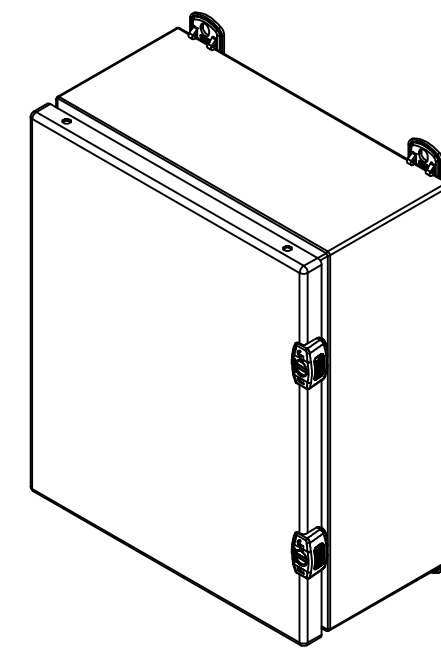

Isometric View



Tél: (450) 979-4373  
 Fax: (450) 979-4626  
[www.exmweb.com](http://www.exmweb.com)

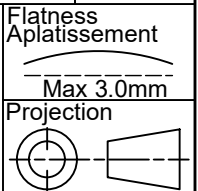

Customer Client	Date
Drawn By / Dessiné Par: BoxCad: BoxCad	Date: 20-Nov-13
Material / Matière: 16 Ga Cold Rolled A1008 CS Type B (1.4mm)	

Color / Couleur: Light Grey RAL7035	Finish / Fini: Rough Textured
Description: 5412ESCHB 12" x 10" x 5" Assembly	
Part Number / Numéro Pièce: <b>5412ESCHB121005</b>	Rev. 0

PACKING		
ITEM	QTY	DESCRIPTION
STK-E-04316	1	CARTON 5412 ESCH121005
Plastic bag	1	To protect cover surface and inside gasket
Packaging label	1	White label with product number
STK-S-01100	1	ESCH EXM SQUARE STICKER

Qty	Part Number	Rev	Description
1	5412ESCHB121005C	0	5412ESCHB 12" x 10" Cover
1	880 SP1210G	0	880 SP1210G - Inner Panel
1	STK-K-02940	2	5412 ESCHB Accessory Kit
1	5412ESCHB121005B	0	5412ESCHB 12" x 10" x 5" Body
2	STK-Q-08100	1	M5 Nylon Insert Lock Nut
2	STK-Q-10249	0	M5 Sealing Washer

Parts List

This drawing is confidential and must not be reproduced or used without the consent of EXM

Ce dessin est confidentiel et ne doit pas être reproduit ou utilisé sans le consentement de EXM

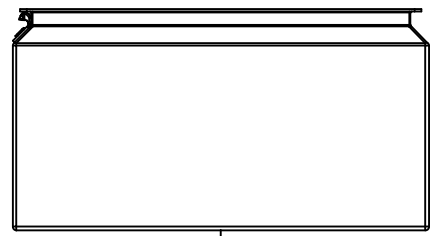

TOP

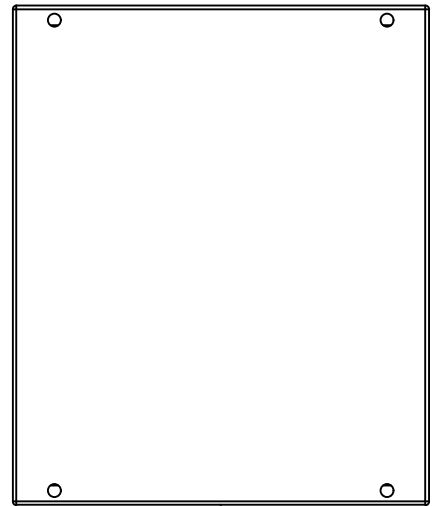

BACK

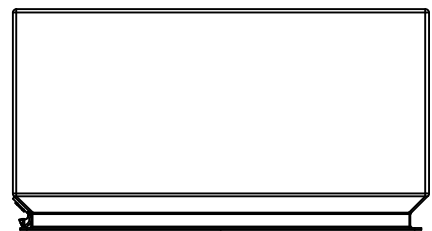

BOTTOM

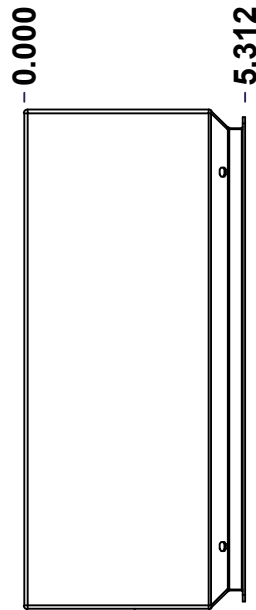

LEFT

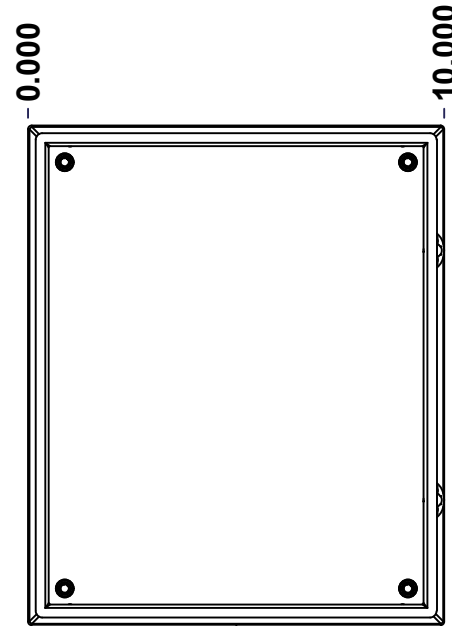

FRONT

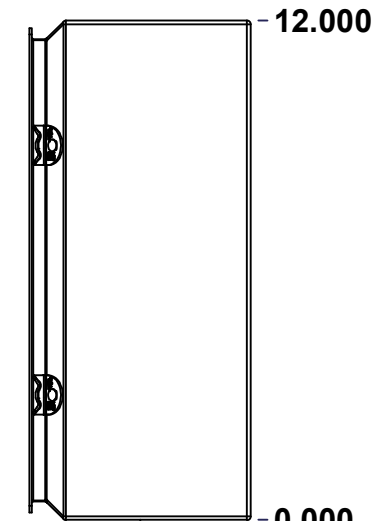

RIGHT

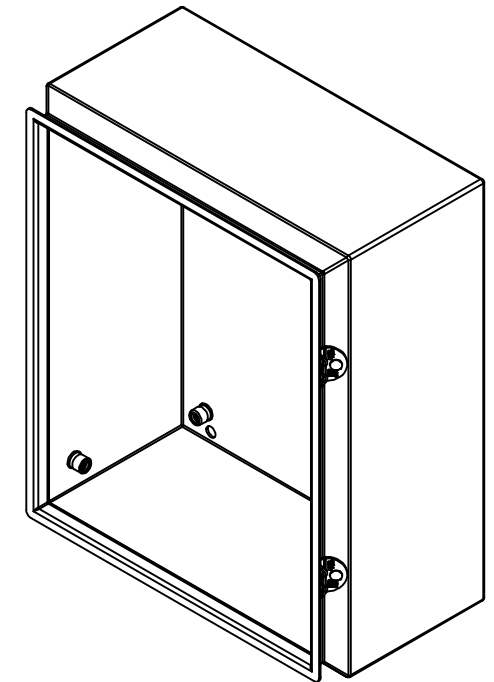

Isometric View



Tél: (450) 979-4373  
 Fax: (450) 979-4626  
[www.exmweb.com](http://www.exmweb.com)

Flatness  
Aplatissement

Max 3.0mm

Projection

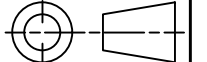

Customer Client	Date
Drawn By Dessiné Par BoxCad: BoxCad	Date 20-Nov-13
Material Matière 16 Ga Cold Rolled A1008 CS Type B (1.4mm)	
Color Couleur Light Grey RAL7035	Finish Fini Rough Textured
Description 5412ESCHB 12" x 10" x 5" Body	Detail Rev.
Part Number Numéro Pièce <b>5412ESCHB121005B</b>	Rev. <b>0</b>
	3 9

SEE BILL OF MATERIAL ON LAST PAGE

This drawing is confidential and must not be reproduced or used without the consent of EXM

Ce dessin est confidentiel et ne doit pas être reproduit ou utilisé sans le consentement de EXM

**STANDARD FEATURES ARE NOT LISTED IN THIS HOLE TABLE**

**HOLE TABLE - LEFT VIEW (CUSTOM FEATURE ONLY)**

CUT-OUT	XDIM	YDIM	DESCRIPTION
1	3.625	0.875	STANDOFF M6 x 10mm (Inside)

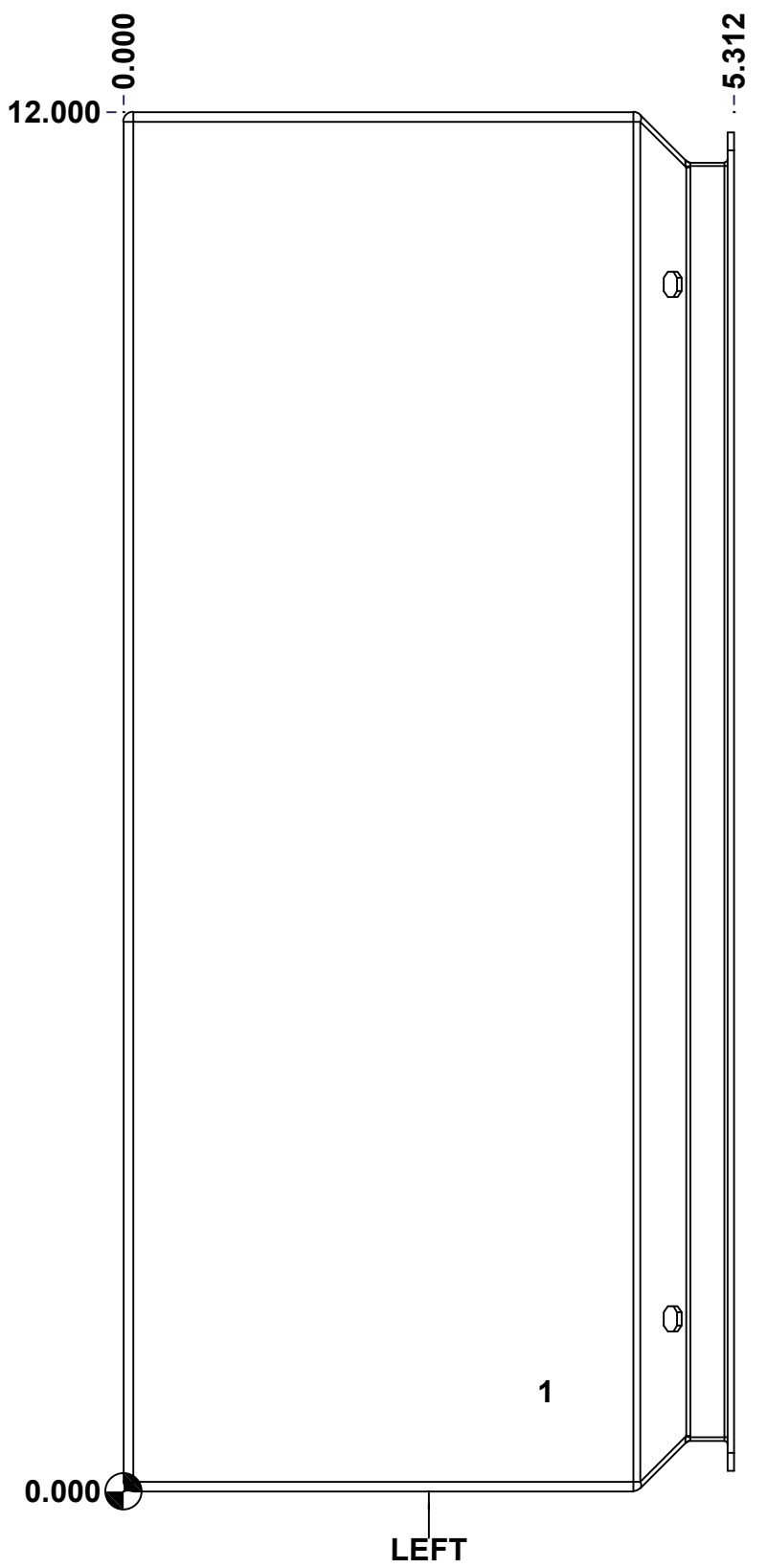

	Description		Status
	5412ESCHB 12" x 10" x 5" Body		(NULL)
Part Number Numéro Pièce		Rev.	4
<b>5412ESCHB121005B</b>		<b>0</b>	9

This drawing is confidential and must not be reproduced or used without the consent of EXM

Ce dessin est confidentiel et ne doit pas être reproduit ou utilisé sans le consentement de EXM

**STANDARD FEATURES ARE NOT LISTED IN THIS HOLE TABLE**

**HOLE TABLE - BACK VIEW (CUSTOM FEATURE ONLY)**

CUT-OUT	XDIM	YDIM	DESCRIPTION
1	0.875	0.875	IP STANDOFF M6 x 10mm (Inside)
2	0.875	11.125	IP STANDOFF M6 x 10mm (Inside)
3	9.125	11.125	IP STANDOFF M6 x 10mm (Inside)
4	9.125	0.875	IP STANDOFF M6 x 10mm (Inside)

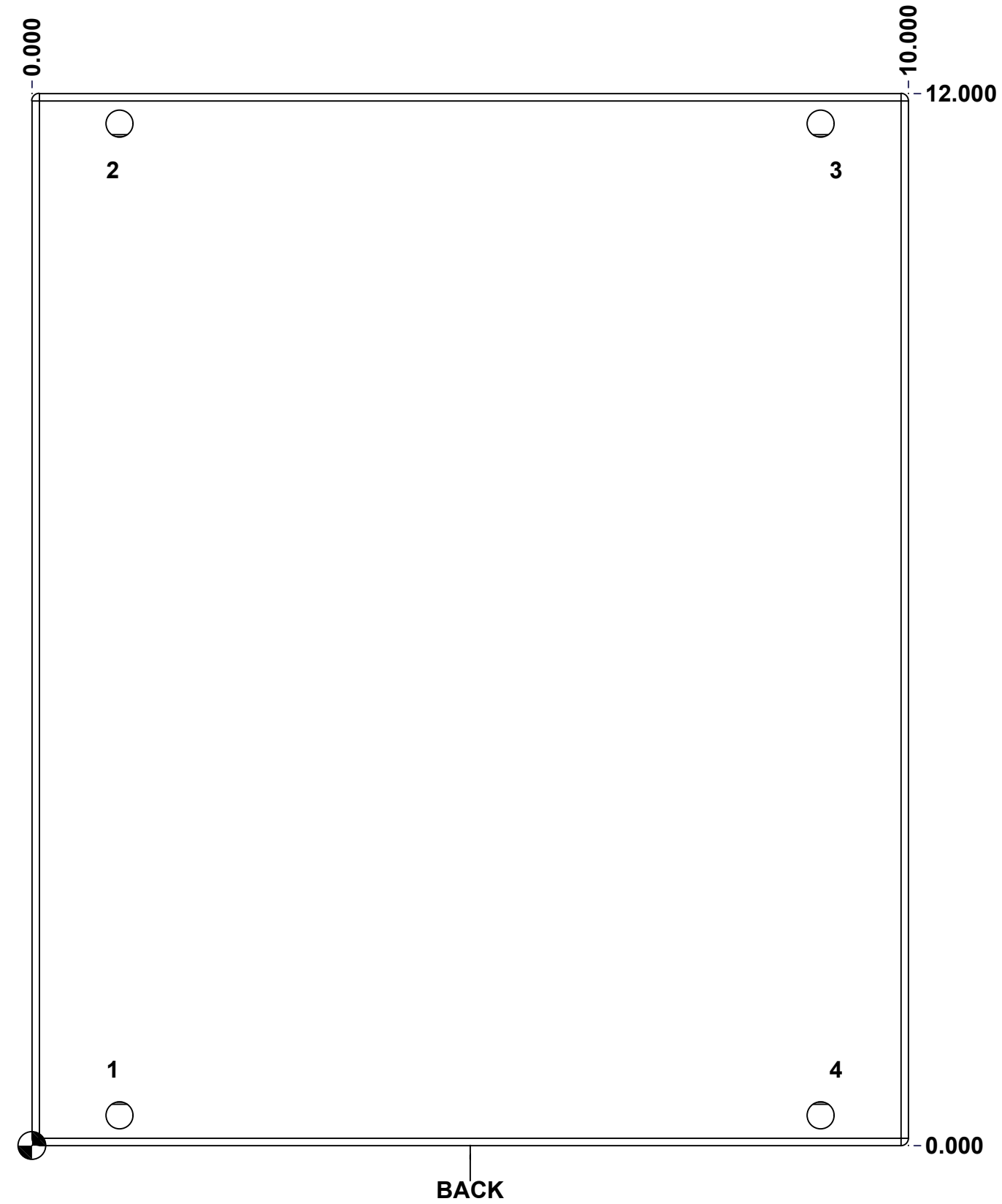



	Description	Status	
	5412ESCHB 12" x 10" x 5" Body	(NULL)	
	Part Number Numéro Pièce	Rev.	
	<b>5412ESCHB121005B</b>	<b>0</b>	5 9

This drawing is confidential and must not be reproduced or used without the consent of EXM

Ce dessin est confidentiel et ne doit pas être reproduit ou utilisé sans le consentement de EXM

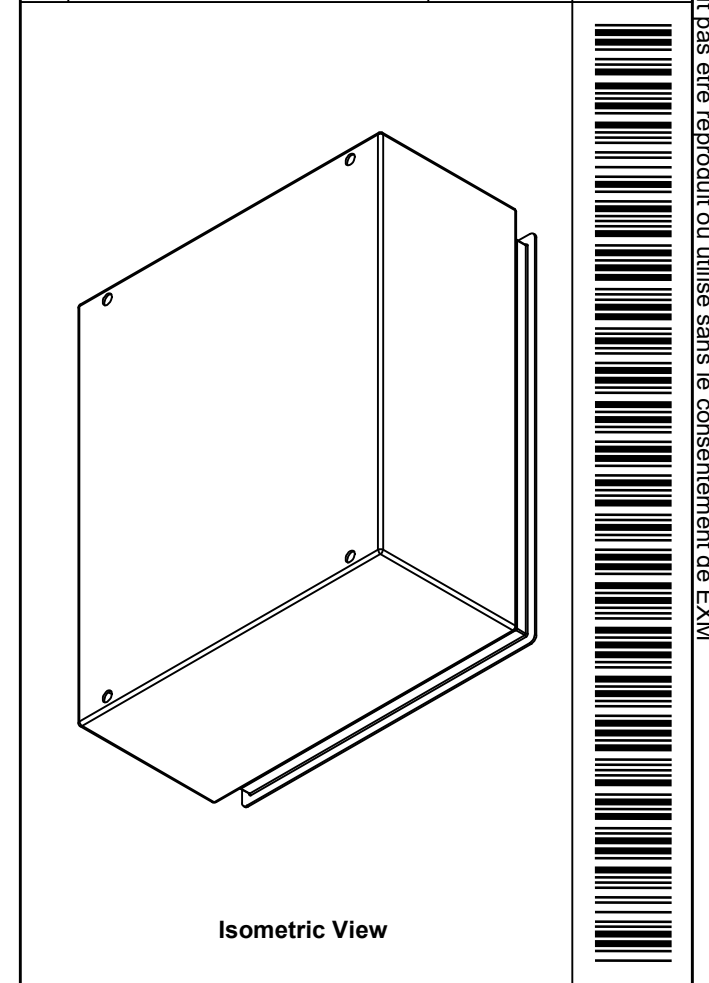
No.	Revisions	Date	By/Par

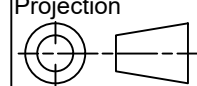

 Tél: (450) 979-4373 Fax: (450) 979-4626 <a href="http://www.exmweb.com">www.exmweb.com</a>		Flatness Aplatissement Max 3.0mm Projection 
Customer Client	Date	
Drawn By Dessiné Par	BoxCad: BoxCad	Date 20-Nov-13
Material Matière	16 Ga Cold Rolled A1008 CS Type B (1.4mm)	
Color Couleur	Light Grey RAL7035	Finish Fini Rough Textured
Description		Detail Rev.
5412ESCHB 12" x 10" x 5" Body		
Part Number Numéro Pièce	Rev.	6
<b>5412ESCHB121005B</b>	<b>0</b>	9

Qty	Part Number	Rev	Description
1	STK-P-03820R	0	Powder Paint (Light Grey / Rough Textured)
1	5412ESCHB121005B-P	0	5412ESCHB 12" x 10" x 5" Body Part
2	STK-A-70469	6	5412 ESSMCH - Stainless Steel 316 Body Catch Assembly
2	STK-Q-08100	1	M5 Nylon Insert Lock Nut
5	STK-Q-08350	5	Standoff M6 x 10mm
Parts List			

This drawing is confidential and must not be reproduced or used without the consent of EXM

Ce dessin est confidentiel et ne doit pas être reproduit ou utilisé sans le consentement de EXM

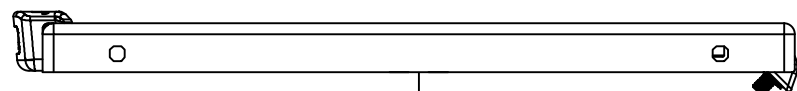

TOP

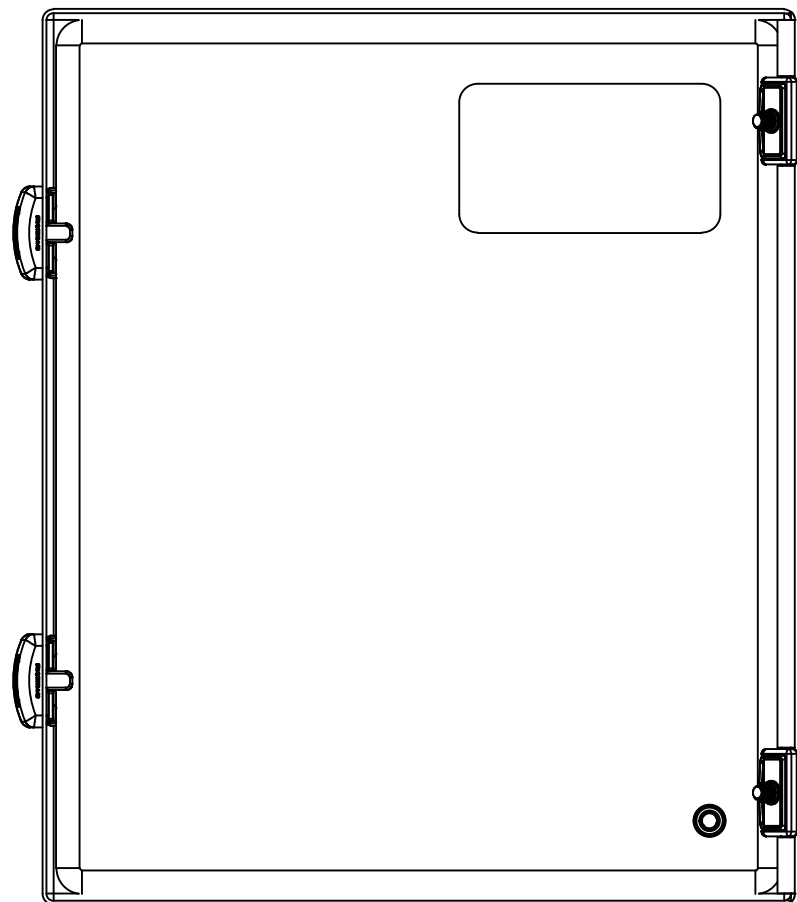

BACK

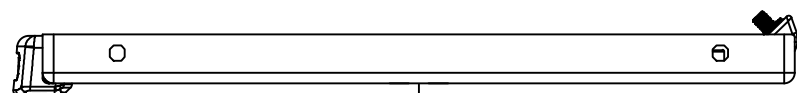

BOTTOM

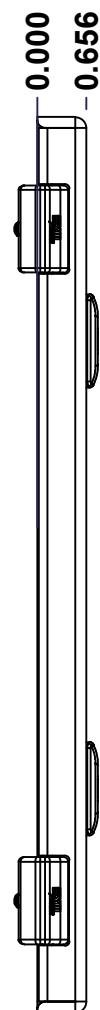

LEFT

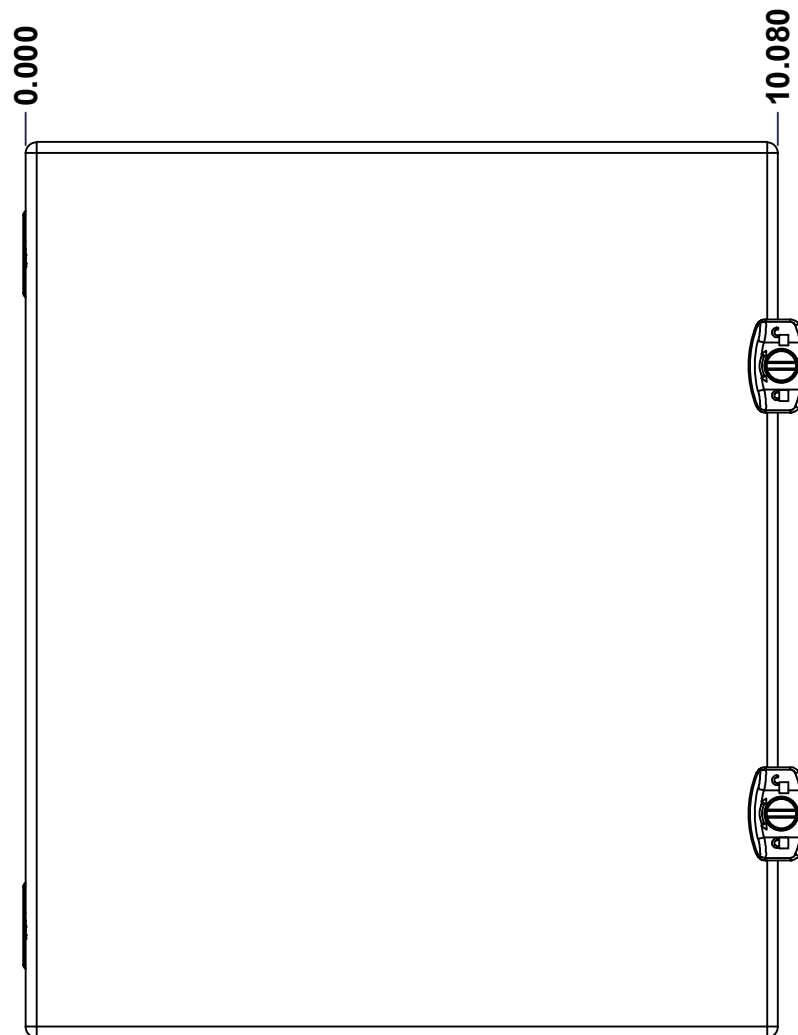

FRONT

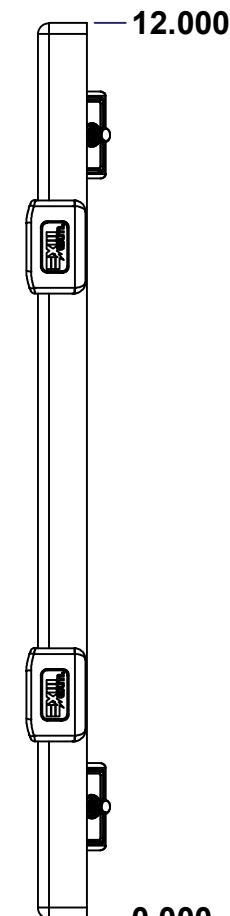

RIGHT

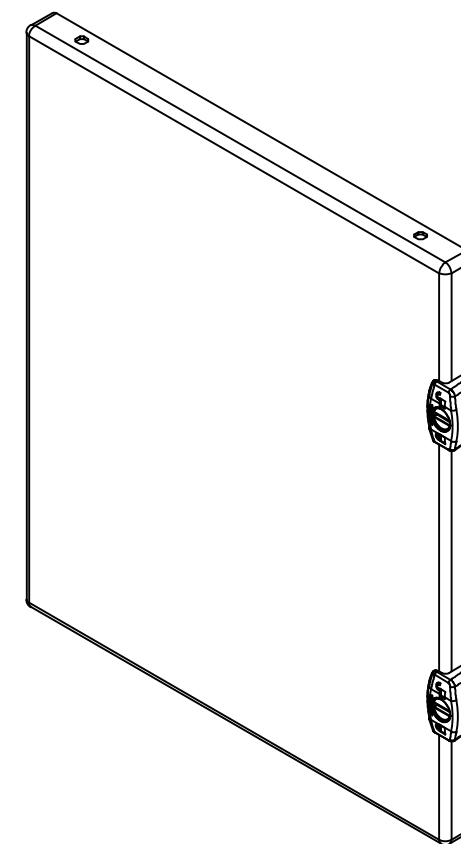

Isometric View

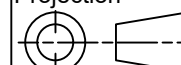

No.	Revisions	Date	By/Par

 Tél: (450) 979-4373 Fax: (450) 979-4626 <a href="http://www.exmweb.com">www.exmweb.com</a>		Flatness Aplatissement Max 3.0mm Projection 
Customer Client	Date	
Drawn By Dessiné Par	BoxCad: BoxCad	Date 20-Nov-13
Material Matière	16 Ga Cold Rolled A1008 CS Type B (1.4mm)	
Color Couleur	Light Grey RAL7035	Finish Fini Rough Textured
Description		Detail Rev.
5412ESCHB 12" x 10" Cover		
Part Number Numéro Pièce	Rev.	7
5412ESCHB121005C	0	9

SEE BILL OF MATERIAL ON LAST PAGE

This drawing is confidential and must not be reproduced or used without the consent of EXM

Ce dessin est confidentiel et ne doit pas être reproduit ou utilisé sans le consentement de EXM

STANDARD FEATURES ARE NOT LISTED IN THIS HOLE TABLE			
HOLE TABLE - FRONT VIEW (CUSTOM FEATURE ONLY)			
CUT-OUT	XDIM	YDIM	DESCRIPTION
1	1.145	1.125	STANDOFF M6 x 10mm (Inside)
2	2.750	10.000	LABEL_EXM
3	10.080	9.000	LOCK 880 SCQ2MS @ 0.0°
4	10.080	3.000	LOCK 880 SCQ2MS @ 0.0°

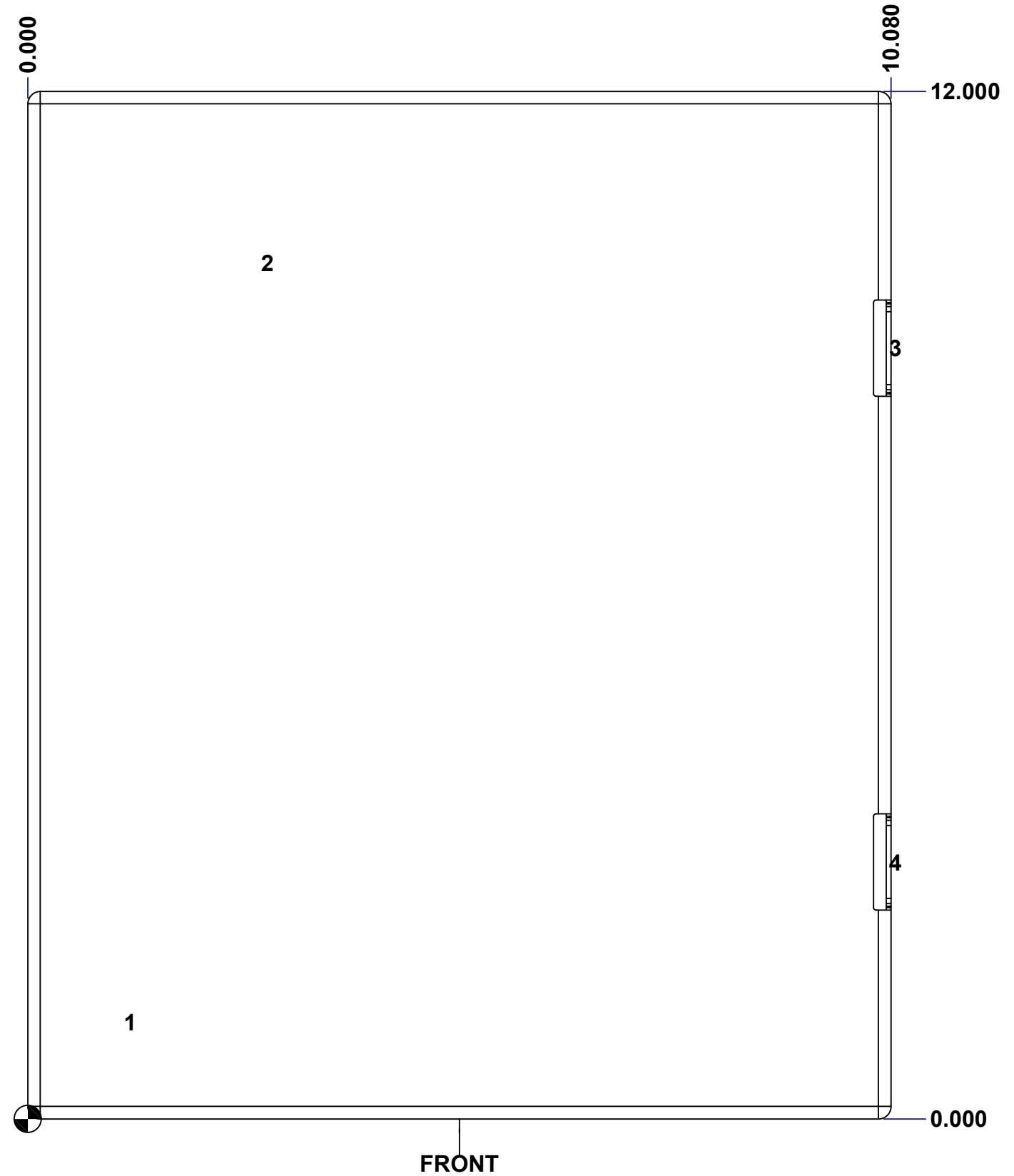

	Description	Status
	5412ESCHB 12" x 10" Cover	(NULL)
	Part Number Numéro Pièce	Rev.
	<b>5412ESCHB121005C</b>	<b>0</b> / 8 / 9



This drawing is confidential and must not be reproduced or used without the consent of EXM

Ce dessin est confidentiel et ne doit pas être reproduit ou utilisé sans le consentement de EXM

No.	Revisions	Date	By/Par

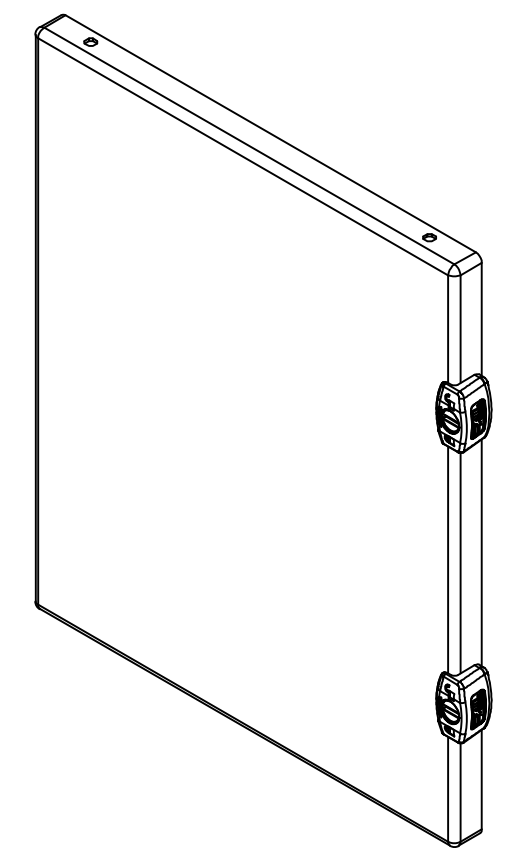

Isometric View

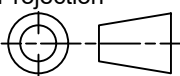

 Tél: (450) 979-4373 Fax: (450) 979-4626 <a href="http://www.exmweb.com">www.exmweb.com</a>	Flatness Aplatissement	Max 3.0mm
	Projection	
Customer Client	Date	
Drawn By Dessiné Par	BoxCad: BoxCad	Date 20-Nov-13
Material Matière	16 Ga Cold Rolled A1008 CS Type B (1.4mm)	
Color Couleur	Light Grey RAL7035	Finish Fini Rough Textured
Description	Detail Rev.	
5412ESCHB 12" x 10" Cover		
Part Number Numéro Pièce	Rev.	9
<b>5412ESCHB121005C</b>	<b>0</b>	<b>9</b>

Qty	Part Number	Rev	Description
1	5412ESCHB121005G	0	5412ESCHB 12" x 10" Gasket
1	STK-S-00100	0	3.5" x 2" Silver Milar Flexcon Sticker
1	STK-Q-08350	5	Standoff M6 x 10mm
1	STK-P-03820R	0	Powder Paint (Light Grey / Rough Textured)
1	5412ESCHB121005C-P	0	5412ESCHB 12" x 10" Cover Part
2	STK-A-33033	4	5412 ESMCH Hinge
2	880SCQ2MS	3	5412 ESMCH - External Lock Assy - Slot Lock
Parts List			

This drawing is confidential and must not be reproduced or used without the consent of EXM

Ce dessin est confidentiel et ne doit pas être reproduit ou utilisé sans le consentement de EXM

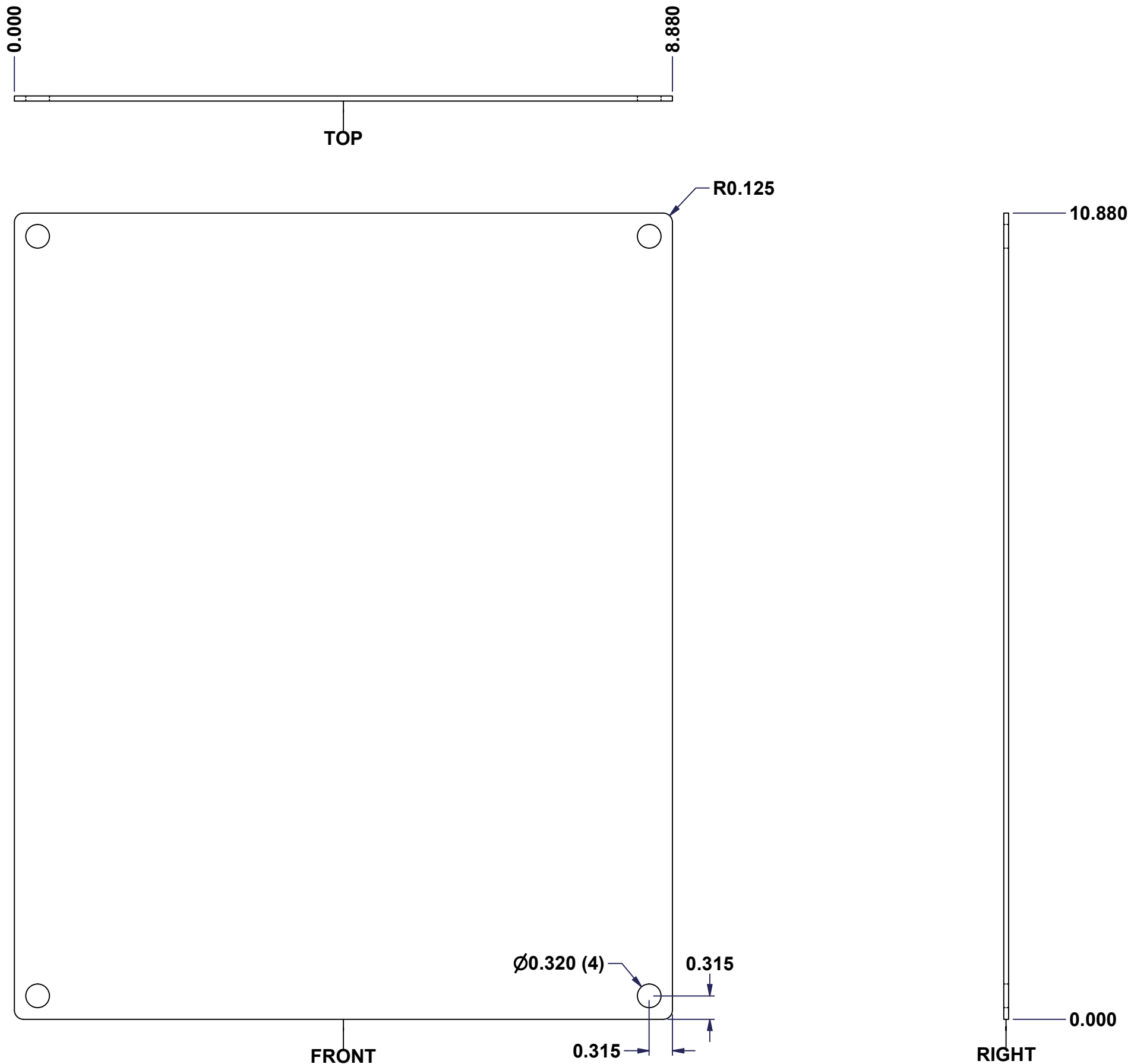

No.	Revisions	Date	By/Par

**Isometric View**

Tél: (450) 979-4373 Fax: (450) 979-4626 www.exmweb.com		Flatness Aplatissement Max 3.0mm
Projection 		Date
Customer Client	BoxCad	Date 23-Jan-07
Material Matière	14 Ga Galvanized (1.7mm)	
Color Couleur	Unpainted	Finish Fini Galvanized
Description	880 SP1210G - Inner Panel	
Part Number Numéro Pièce	880 SP1210G	Detail Rev. Rev. 1 0 2

SEE BILL OF MATERIAL ON LAST PAGE

This drawing is confidential and must not be reproduced or used without the consent of EXM

Ce dessin est confidentiel et ne doit pas être reproduit ou utilisé sans le consentement de EXM

No.	Revisions	Date	By/Par

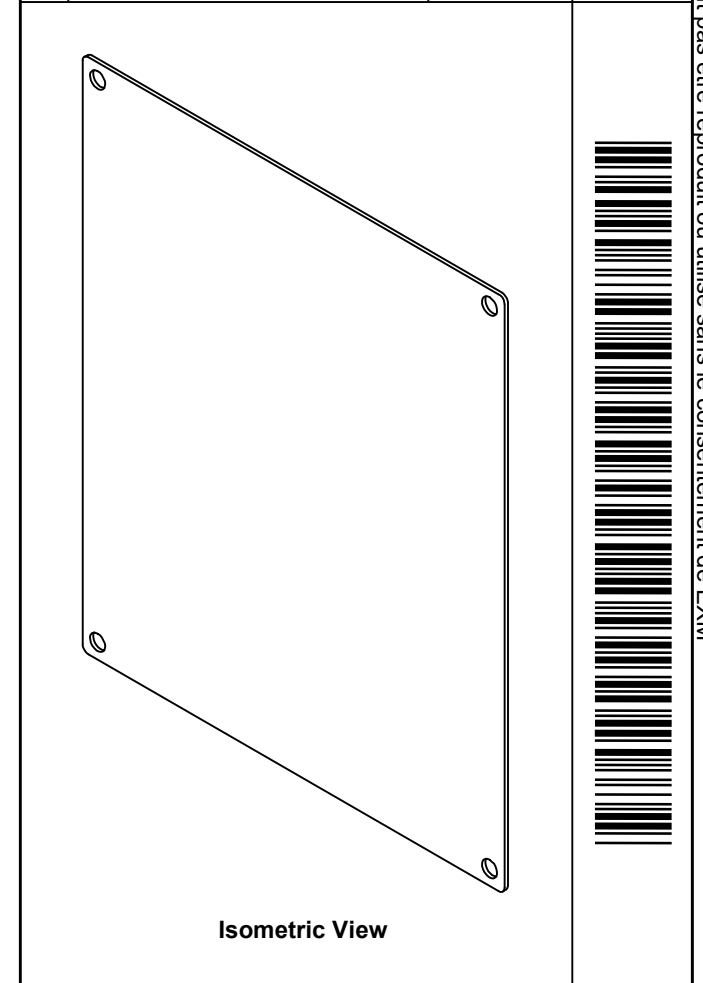

 Tél: (450) 979-4373 Fax: (450) 979-4626 www.exmweb.com		Flatness Aplatissement Max 3.0mm
Customer Client		Date
Drawn By / Dessiné Par: BoxCad		Date: 23-Jan-07
Material / Matière: 14 Ga Galvanized (1.7mm)		
Color / Couleur: Unpainted	Finish / Fini: Galvanized	
Description: 880 SP1210G - Inner Panel		Detail Rev.
Part Number / Numéro Pièce: <b>880 SP1210G</b>		Rev. 0 / 2

Qty	Part Number	Rev	Description
1	880 SP1210G-P	0	880 SP1210G - Inner Panel Part
Parts List			