

This drawing is confidential and must not be reproduced or used without the consent of EXM

Ce dessin est confidentiel et ne doit pas être reproduit ou utilisé sans le consentement de EXM

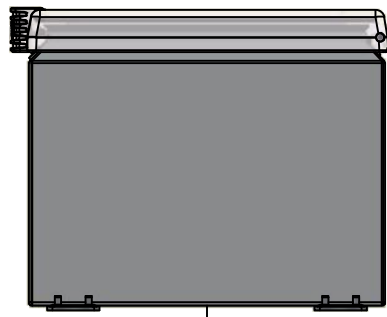

TOP

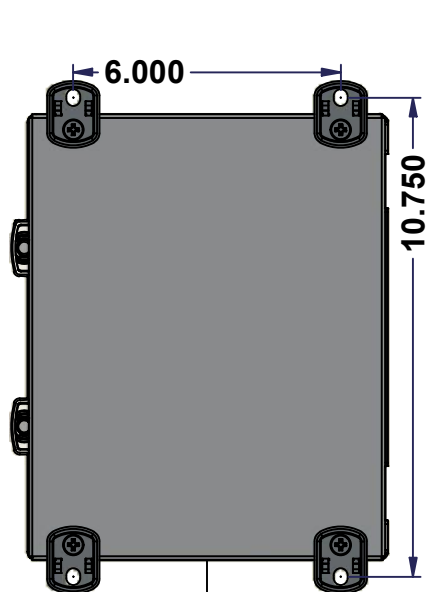

BACK

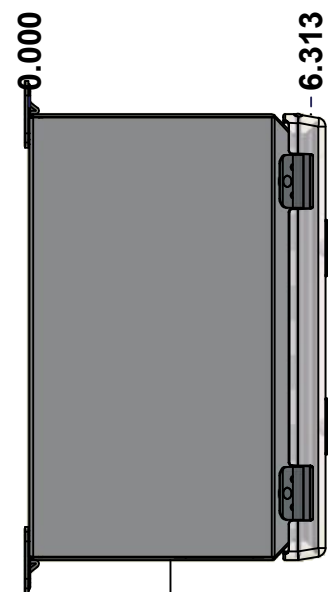

LEFT

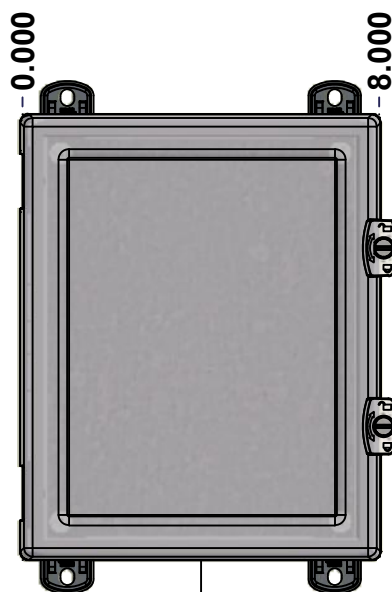

FRONT

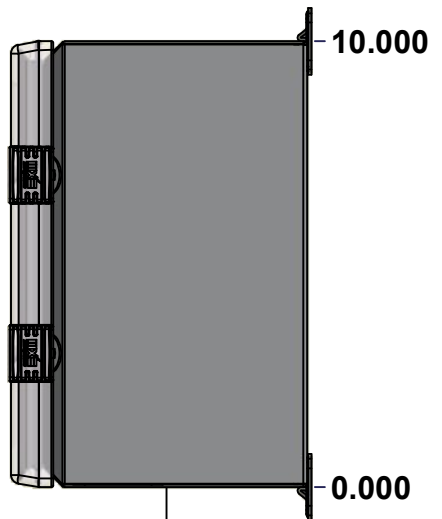

RIGHT

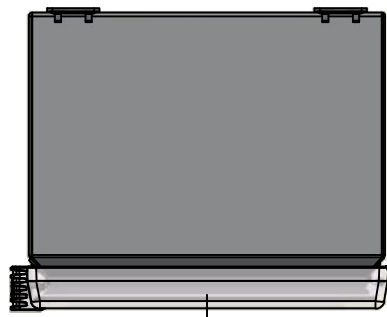

BOTTOM



Isometric View

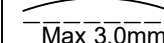
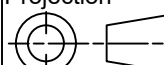

No.	Revisions	Date	By/Par

 Tél: (450) 979-4373 Fax: (450) 979-4626 www.exmweb.com		Flatness Aplatissement  Max 3.0mm Projection 
Customer Client	Date	
Drawn By Dessiné Par	BoxCad: BoxCad	Date 6/16/2014
Material Matière	16 Ga Cold Rolled A1008 CS Type B (1.4mm)	
Color Couleur	Asa-61 Grey	Finish Fini Smooth
Description	Detail Rev.	
5412ESCHV 10" x 8" x 6" Assembly		
Part Number Numéro Pièce	Rev. 1	7
5412ESCHV100806		0

SEE BILL OF MATERIAL ON LAST PAGE

This drawing is confidential and must not be reproduced or used without the consent of EXM

Ce dessin est confidentiel et ne doit pas être reproduit ou utilisé sans le consentement de EXM

NOTE	
ITEM	DESCRIPTION
1	NEMA 4/12 Enclosure
2	W/O Standard ground standoffs on box and cover
3	W/O Standard door stiffener
4	C/W Standard inner panel (Included)
5	C/W Standard inner panel mounting standoffs

No.	Revisions	Date	By/Par

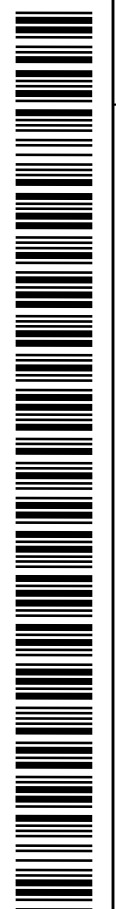
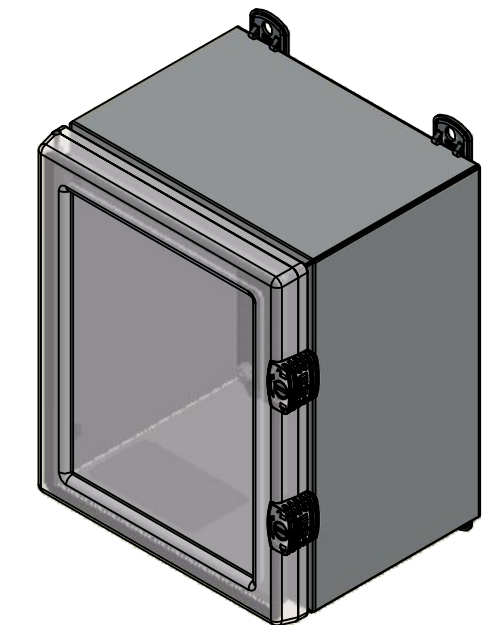

Isometric View



Tél: (450) 979-4373
 Fax: (450) 979-4626
www.exmweb.com



Customer Client	Date
Drawn By / Dessiné Par: BoxCad: BoxCad	Date: 6/16/2014
Material / Matière: 16 Ga Cold Rolled A1008 CS Type B (1.4mm)	

Color / Couleur: Asa-61 Grey	Finish / Fini: Smooth
Description: 5412ESCHV 10" x 8" x 6" Assembly	Detail Rev.
Part Number / Numéro Pièce: 5412ESCHV100806	Rev. 0

PACKING		
ITEM	QTY	DESCRIPTION
STK-E-04311	1	CARTON 5412 ESCH100806
Plastic bag	1	To protect cover surface and inside gasket
Packaging label	1	White label with product number
STK-S-01100	1	ESCH EXM SQUARE STICKER

Qty	Part Number	Rev	Description
1	5412ESCHV100806C	0	5412ESCHV 10" x 8" Cover
1	880 SP1008G	0	880 SP1008G - Inner Panel
1	STK-K-02940	2	5412 ESCHB Accessory Kit
1	5412ESCHV100806B	0	5412ESCHV 10" x 8" x 6" Body
2	STK-Q-08100	1	M5 Nylon Insert Lock Nut
2	STK-Q-10249	0	M5 Sealing Washer

Parts List

This drawing is confidential and must not be reproduced or used without the consent of EXM

Ce dessin est confidentiel et ne doit pas être reproduit ou utilisé sans le consentement de EXM



TOP

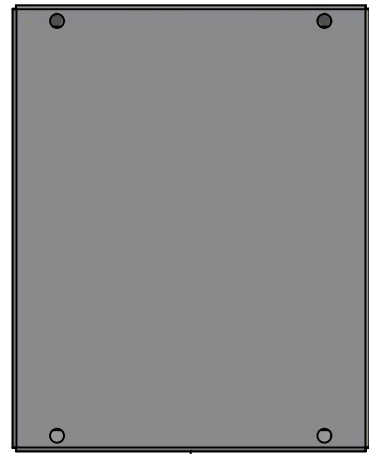

BACK

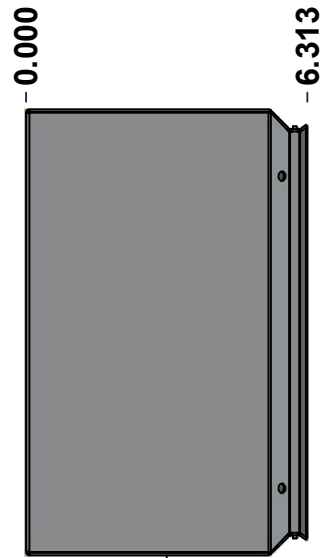

LEFT

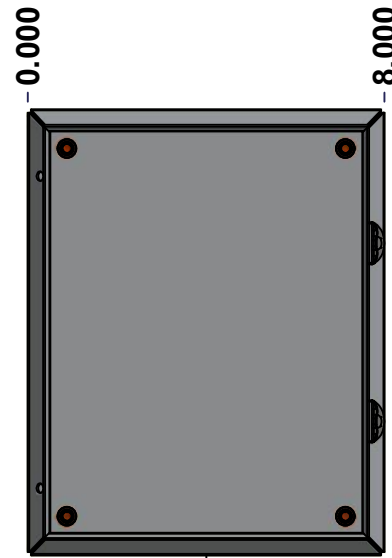

FRONT

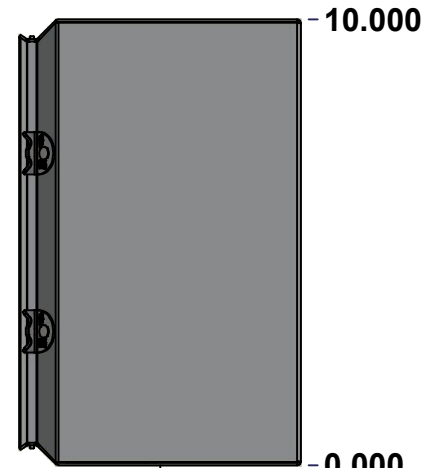

RIGHT



BOTTOM

No.	Revisions	Date	By/Par

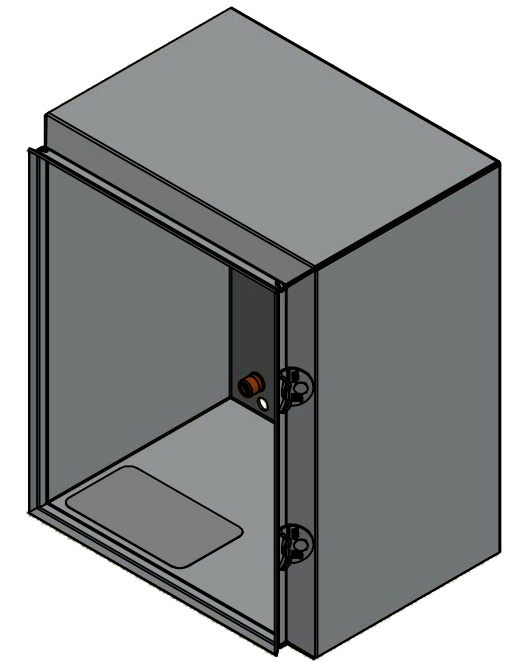

Isometric View



Tél: (450) 979-4373
 Fax: (450) 979-4626
www.exmweb.com

Flatness
Aplatissement

Max 3.0mm

Projection

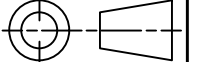

Customer Client	Date
Drawn By / Dessiné Par: BoxCad: BoxCad	Date: 6/16/2014
Material / Matière: 16 Ga Cold Rolled A1008 CS Type B (1.4mm)	

Color / Couleur: Asa-61 Grey	Finish / Fini: Smooth
------------------------------	-----------------------

Description: 5412ESCHV 10" x 8" x 6" Body	Detail Rev.
---	-------------

Part Number / Numéro Pièce: 5412ESCHV100806B	Rev. 0	3 / 7
--	--------	-------

SEE BILL OF MATERIAL ON LAST PAGE

This drawing is confidential and must not be reproduced or used without the consent of EXM

Ce dessin est confidentiel et ne doit pas être reproduit ou utilisé sans le consentement de EXM

STANDARD FEATURES ARE NOT LISTED IN THIS HOLE TABLE

HOLE TABLE - BOTTOM VIEW (CUSTOM FEATURE ONLY)

CUT-OUT	XDIM	YDIM	DESCRIPTION
1	2.000	4.250	LABEL_EXM

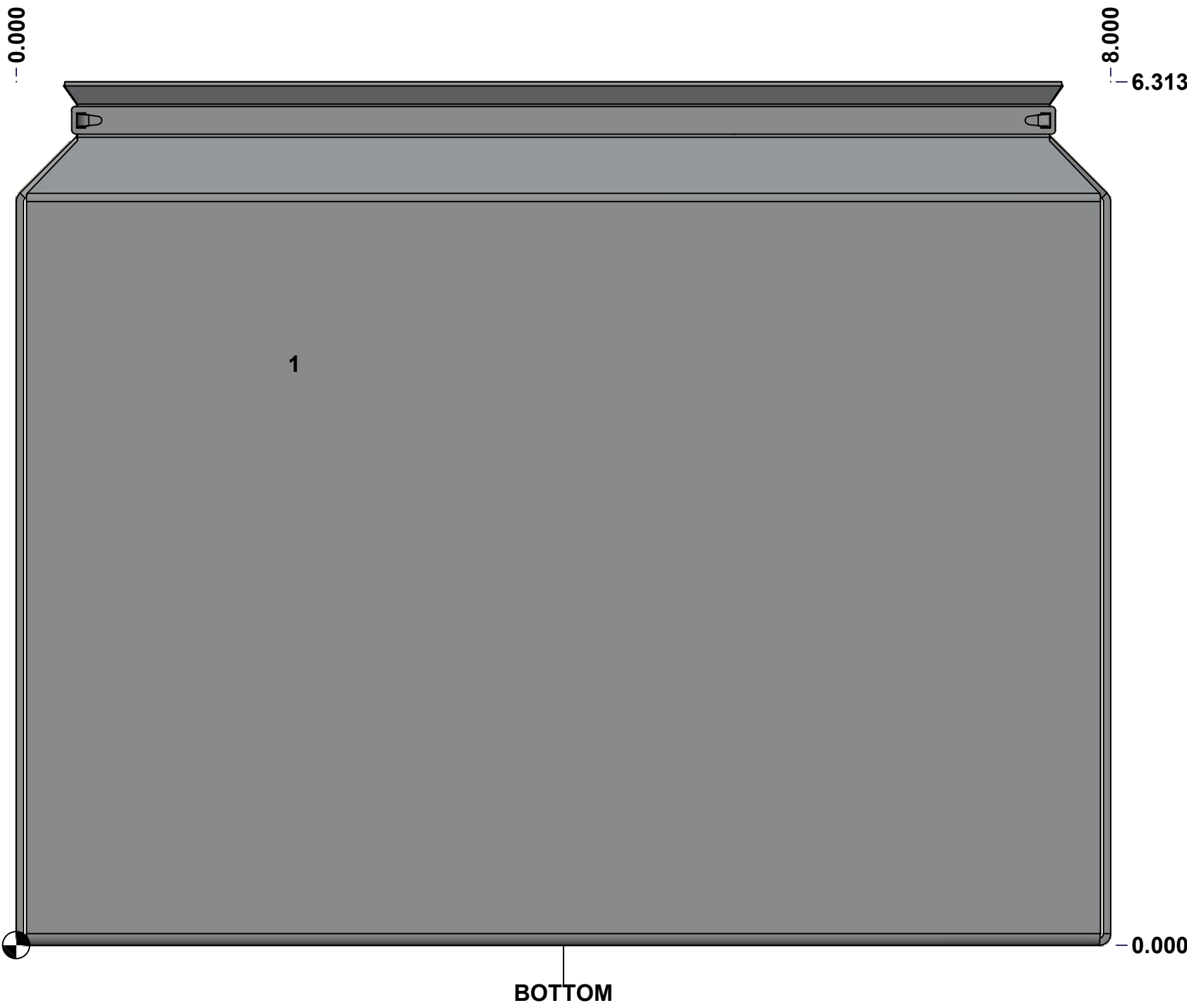

	Description	Status	
	5412ESCHV 10" x 8" x 6" Body	(NULL)	
	Part Number Numéro Pièce	Rev.	
	5412ESCHV100806B	0	4/7

This drawing is confidential and must not be reproduced or used without the consent of EXM

Ce dessin est confidentiel et ne doit pas être reproduit ou utilisé sans le consentement de EXM

STANDARD FEATURES ARE NOT LISTED IN THIS HOLE TABLE

HOLE TABLE - BACK VIEW (CUSTOM FEATURE ONLY)

CUT-OUT	XDIM	YDIM	DESCRIPTION
1	0.875	0.875	IP STANDOFF M6 x 10mm (Inside)
2	0.875	9.125	IP STANDOFF M6 x 10mm (Inside)
3	7.125	9.125	IP STANDOFF M6 x 10mm (Inside)
4	7.125	0.875	IP STANDOFF M6 x 10mm (Inside)

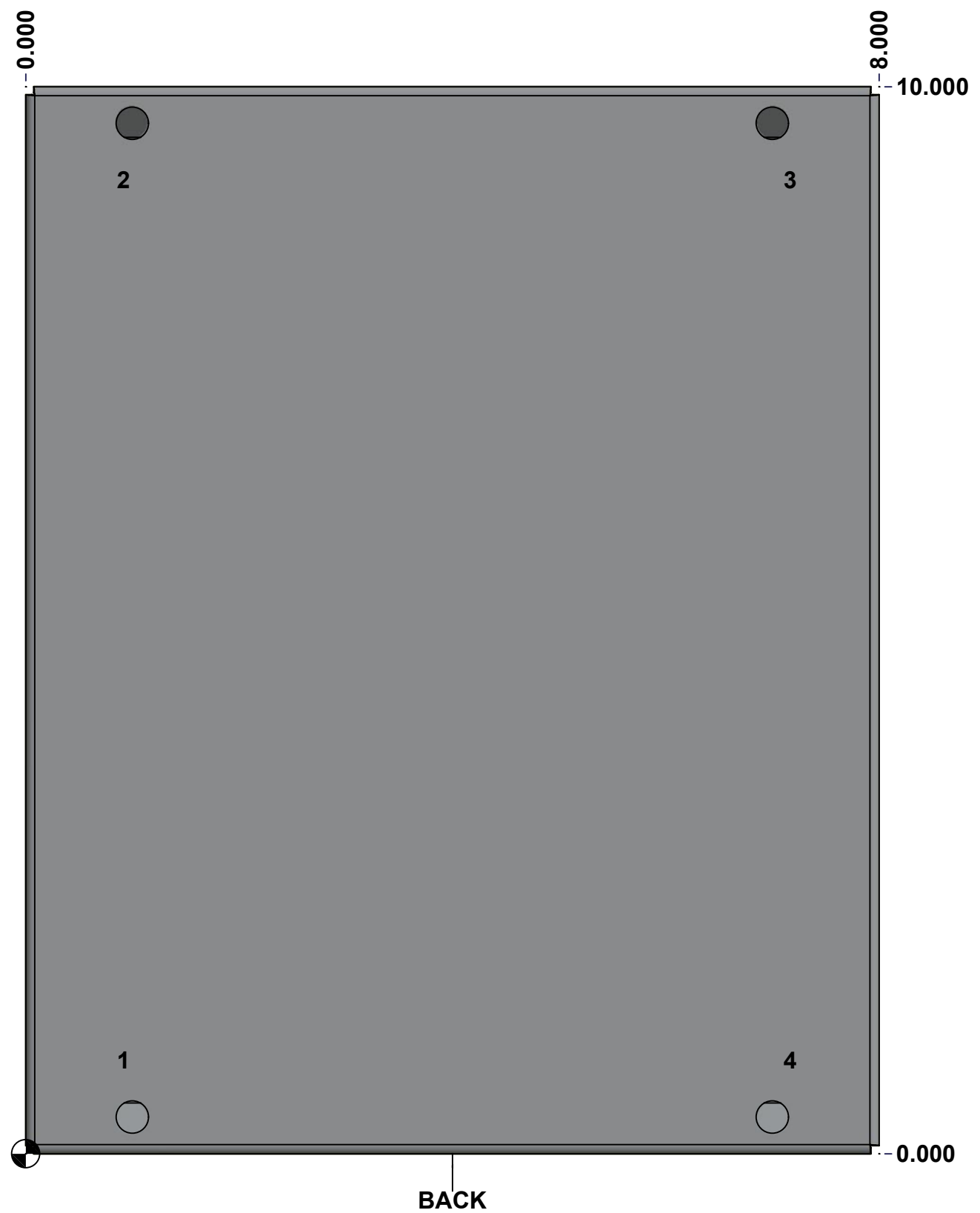

	Description		Status
	5412ESCHV 10" x 8" x 6" Body		(NULL)
Part Number Numéro Pièce		Rev.	5 7
5412ESCHV100806B		0	

This drawing is confidential and must not be reproduced or used without the consent of EXM

Ce dessin est confidentiel et ne doit pas être reproduit ou utilisé sans le consentement de EXM

No.	Revisions	Date	By/Par

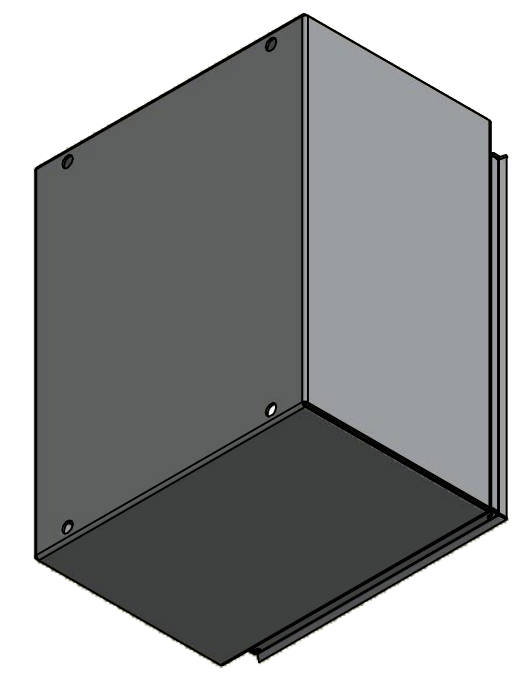

Isometric View

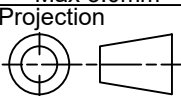

 Tél: (450) 979-4373 Fax: (450) 979-4626 www.exmweb.com		Flatness Aplatissement Max 3.0mm Projection 
Customer Client	Date	
Drawn By Dessiné Par	BoxCad: BoxCad	Date 6/16/2014
Material Matière	16 Ga Cold Rolled A1008 CS Type B (1.4mm)	
Color Couleur	Asa-61 Grey	Finish Fini Smooth
Description		Detail Rev.
5412ESCHV 10" x 8" x 6" Body		
Part Number Numéro Pièce	Rev.	6
5412ESCHV100806B	0	7

Qty	Part Number	Rev	Description
1	STK-S-00100	0	3.5" x 2" Silver Milar Flexcon Sticker
1	STK-P-02400S	0	Powder Paint (Asa-61 Grey / Smooth)
1	5412ESCHV100806B-P	0	5412ESCHV 10" x 8" x 6" Body Part
4	STK-Q-08350	5	Standoff M6 x 10mm
2	STK-A-70469	6	5412 ESSMCH - Stainless Steel 316 Body Catch Assembly
2	STK-Q-08100	1	M5 Nylon Insert Lock Nut
Parts List			

This drawing is confidential and must not be reproduced or used without the consent of EXM

Ce dessin est confidentiel et ne doit pas être reproduit ou utilisé sans le consentement de EXM

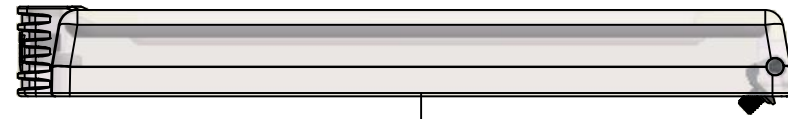

TOP

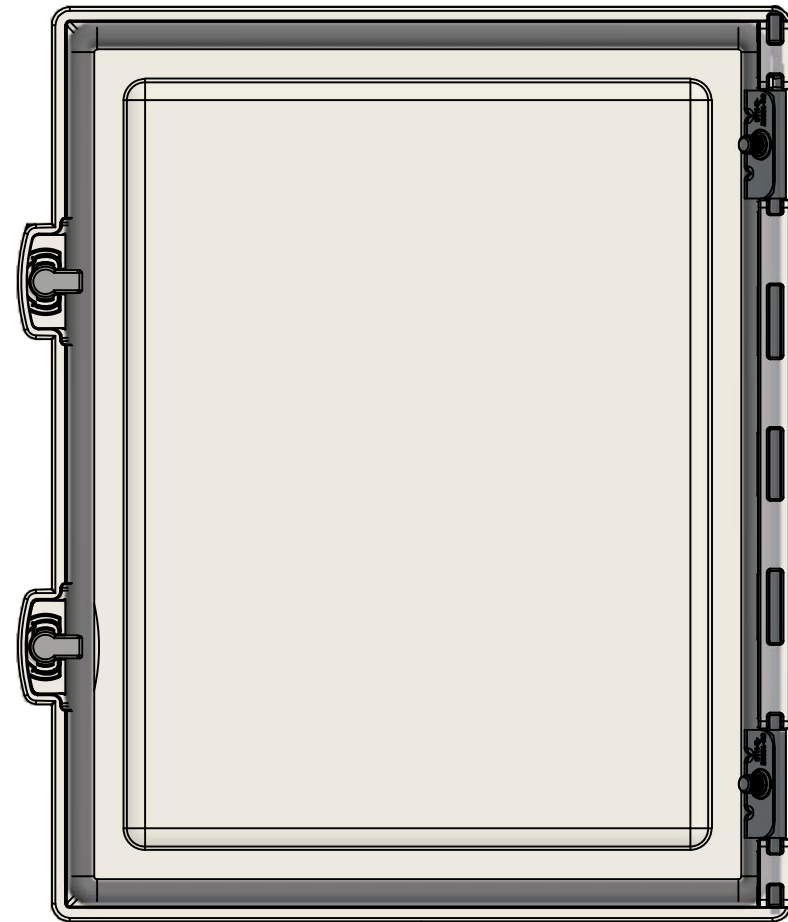

BACK

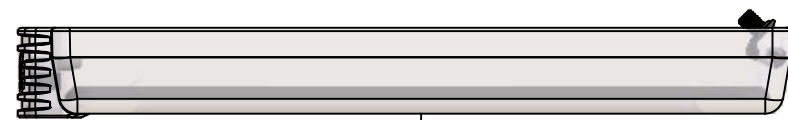

BOTTOM

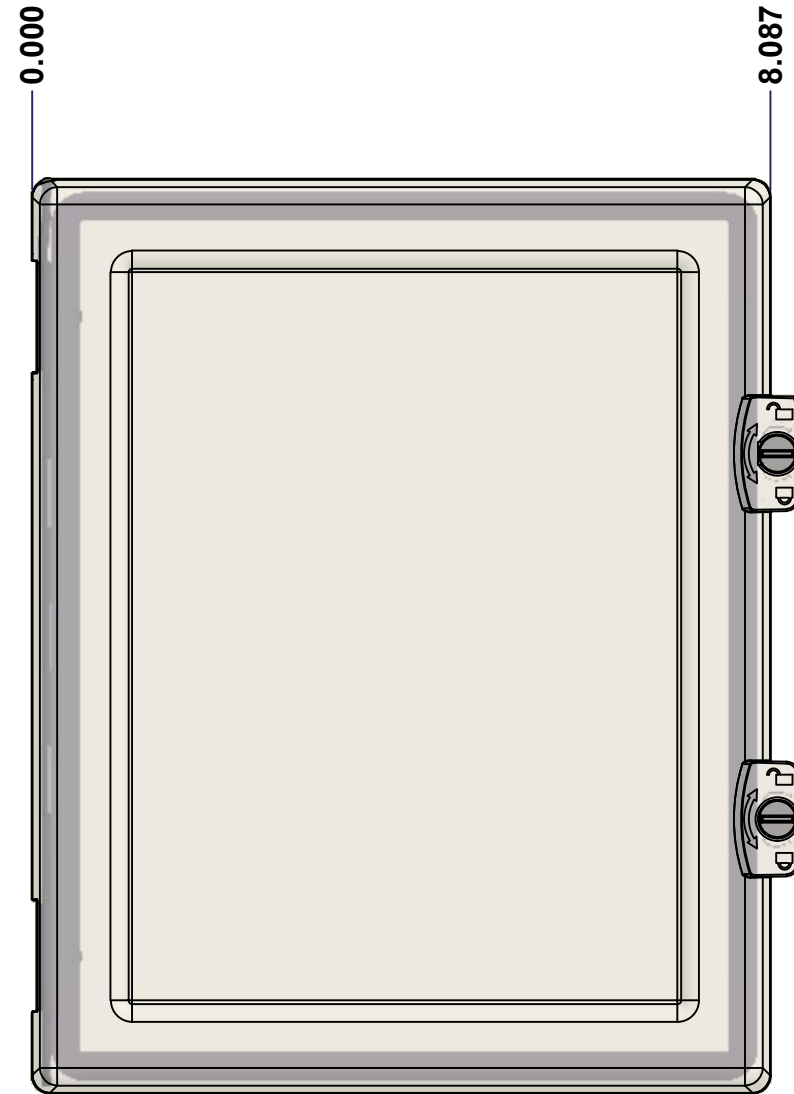
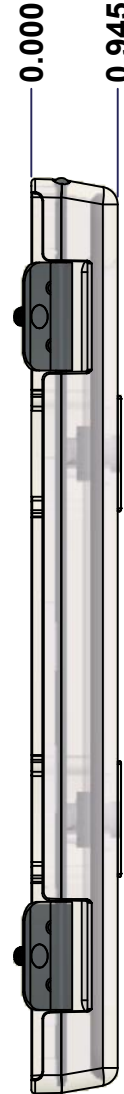

FRONT

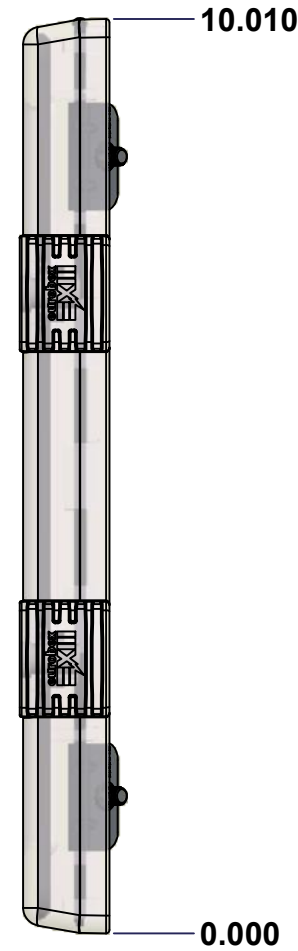

No.	Revisions	Date	By/Par

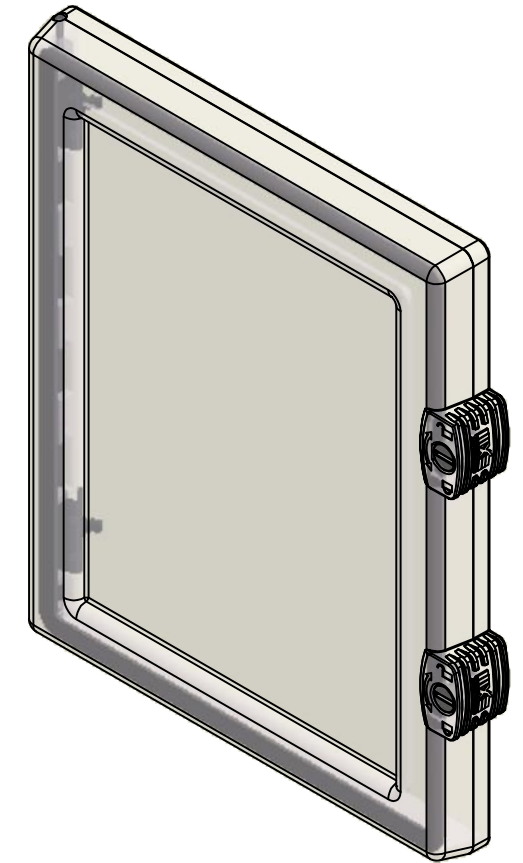

Isometric View



EXM
 Tél: (450) 979-4373
 Fax: (450) 979-4626
www.exmweb.com

Flatness
 Aplatissement
 Max 3.0mm
 Projection

Customer Client
 Drawn By / Dessiné Par: BoxCad: BoxCad
 Material / Matière: Bayers Makrolon 6455
 Date: 6/16/2014

Color / Couleur: Clear Tint Code 1045
 Finish / Fini: Smooth

Description: 5412ESCHV 10" x 8" Cover
 Detail Rev.

Part Number / Numéro Pièce: **5412ESCHV100806C**
 Rev. 0

Qty	Part Number	Rev	Description
1	STK-Q-31100	2	Continuous Hinge Pin Part 10"
1	5412ESCHV100806G	0	5412ESCHV 10" x 8" Gasket
1	880CEW1008-P	1	880 CEW1008 Clear Polycarbonate Window
2	STK-Q-70740	1	Stainless Steel Spring Clip
2	STK-Q-70720	9	5412 ESCH 1/4 Turn Lock - Insert (Slotted)
2	STK-Q-33031	0	5412 ESCH - Zinc Plated Hinge

Parts List

7
7

This drawing is confidential and must not be reproduced or used without the consent of EXM

Ce dessin est confidentiel et ne doit pas être reproduit ou utilisé sans le consentement de EXM

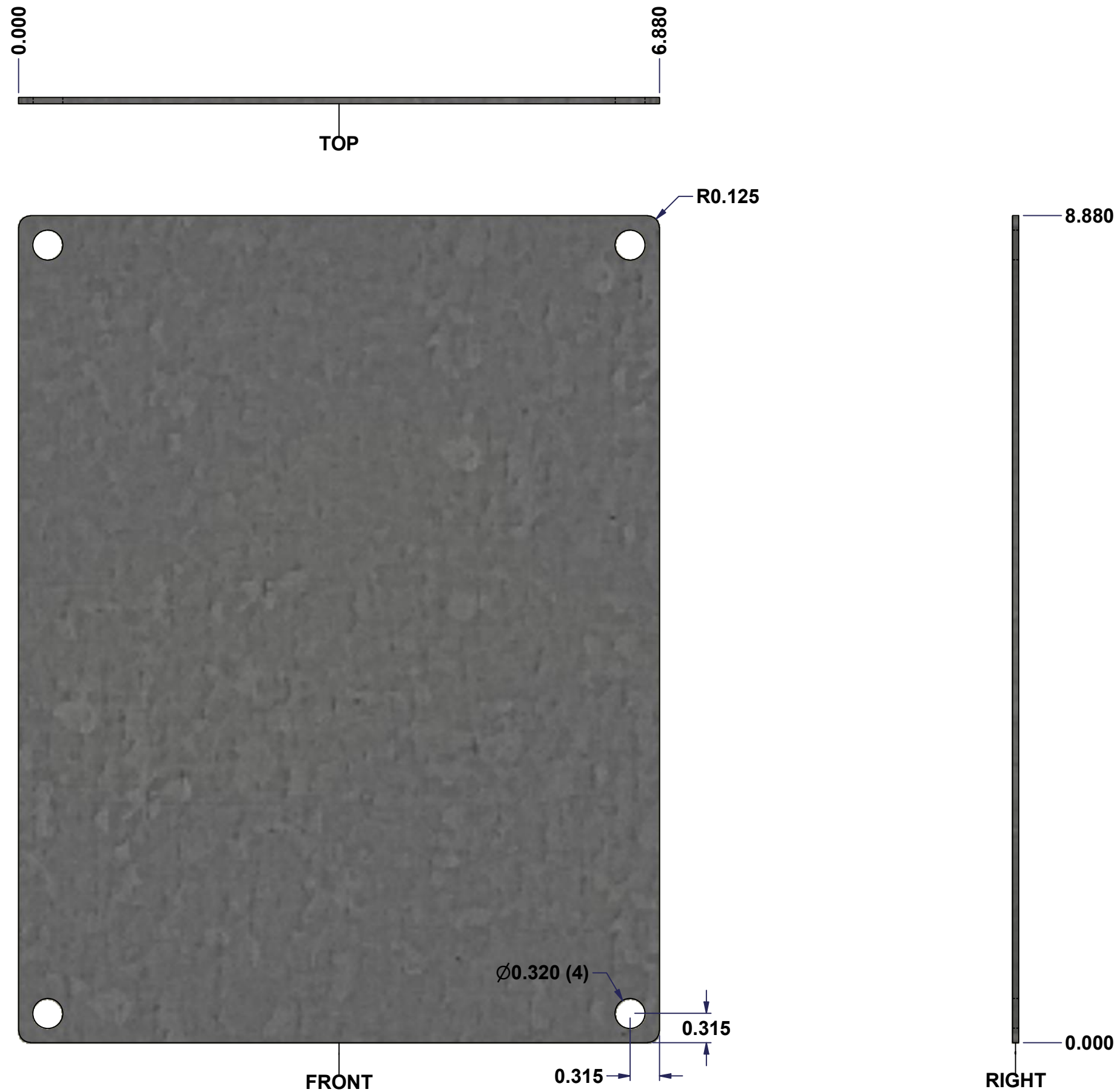

No.	Revisions	Date	By/Par



	Flatness Aplatissement Max 3.0mm
	Projection
Customer Client	Date
Drawn By Dessiné Par BoxCad	Date 23-Jan-07
Material Matière 14 Ga Galvanized (1.7mm)	
Color Couleur Unpainted	Finish Fini Galvanized
Description 880 SP1008G - Inner Panel	
Detail Rev.	
Part Number Numéro Pièce 880 SP1008G	Rev. 1 0 2

SEE BILL OF MATERIAL ON LAST PAGE

This drawing is confidential and must not be reproduced or used without the consent of EXM

Ce dessin est confidentiel et ne doit pas être reproduit ou utilisé sans le consentement de EXM

No.	Revisions	Date	By/Par



 Tél: (450) 979-4373 Fax: (450) 979-4626 www.exmweb.com		Flatness Aplatissement Max 3.0mm
Customer Client		Date
Drawn By / Dessiné Par: BoxCad		Date: 23-Jan-07
Material / Matière: 14 Ga Galvanized (1.7mm)		
Color / Couleur: Unpainted	Finish / Fini: Galvanized	
Description: 880 SP1008G - Inner Panel		Detail Rev.
Part Number / Numéro Pièce: 880 SP1008G		Rev. 0 / 2

Qty	Part Number	Rev.	Description
1	880SP1008G-P	0	880 SP1008G - Inner Panel Part
Parts List			