

This drawing is confidential and must not be reproduced or used without the consent of EXM

Ce dessin est confidentiel et ne doit pas être reproduit ou utilisé sans le consentement de EXM

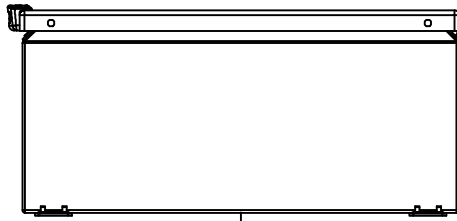

TOP

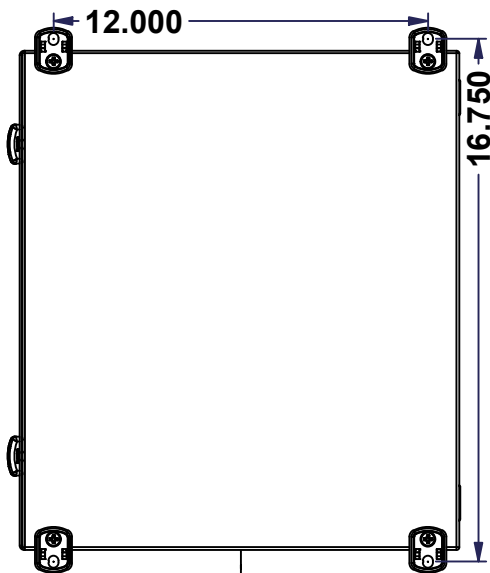

BACK

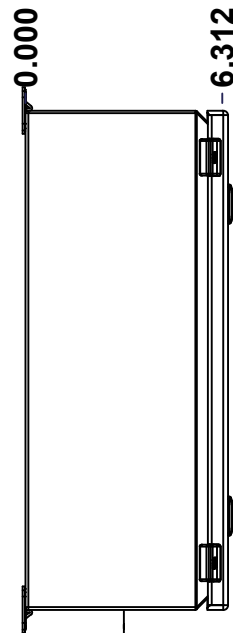

LEFT

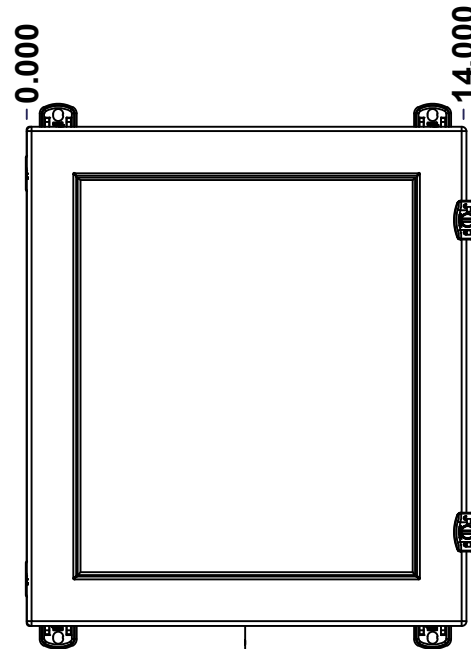

FRONT

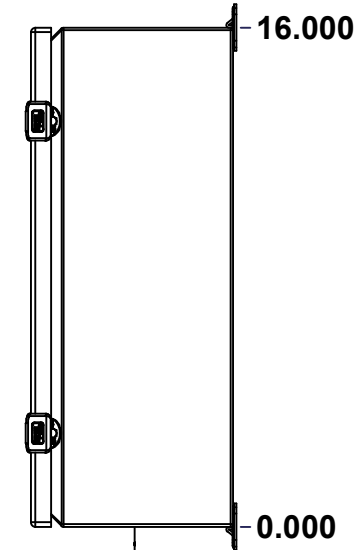

RIGHT



BOTTOM

No.	Revisions	Date	By/Par

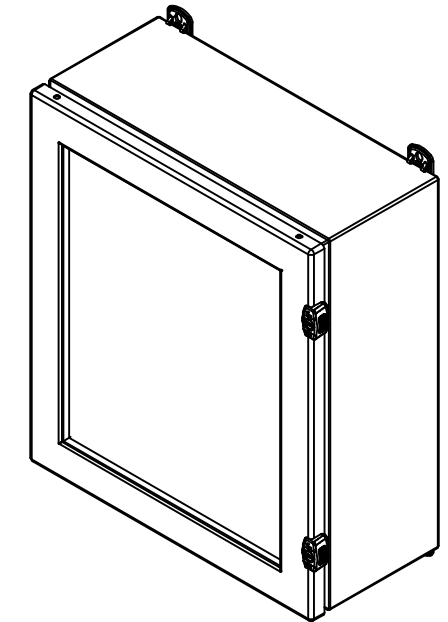

Isometric View



Tél: (450) 979-4373
 Fax: (450) 979-4626
www.exmweb.com

Flatness
Aplatissement

Max 3.0mm

Projection

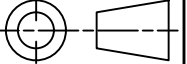

Customer Client	Date
Drawn By Dessiné Par BoxCad: BoxCad	Date 30-Apr-13
Material Matière 16 Ga Cold Rolled A1008 CS Type B (1.4mm)	

Color Couleur Asa-61 Grey	Finish Fini Smooth
------------------------------	-----------------------

Description 5412ESCHW 16" x 14" x 6" Assembly	Detail Rev.
--	-------------

Part Number Numéro Pièce 5412ESCHW161406	Rev. 0	1 / 10
---	--------	--------

SEE BILL OF MATERIAL ON LAST PAGE

This drawing is confidential and must not be reproduced or used without the consent of EXM

Ce dessin est confidentiel et ne doit pas être reproduit ou utilisé sans le consentement de EXM

NOTE	
ITEM	DESCRIPTION
1	NEMA 4/12 Enclosure
2	C/W Standard ground standoffs on box and cover
3	W/O Standard door stiffener
4	C/W Standard inner panel (Included)
5	C/W Standard inner panel mounting standoffs

No.	Revisions	Date	By/Par

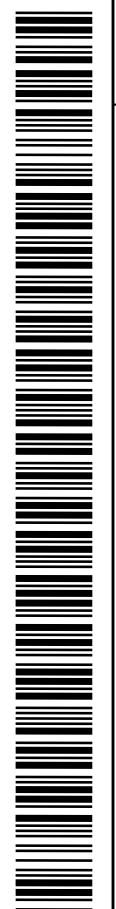
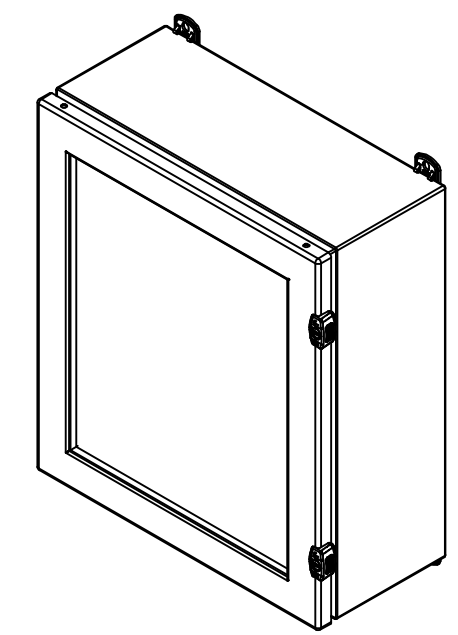

Isometric View



Tél: (450) 979-4373
 Fax: (450) 979-4626
www.exmweb.com

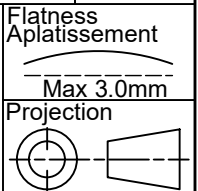

Customer Client	Date
Drawn By / Dessiné Par: BoxCad: BoxCad	Date: 30-Apr-13
Material / Matière: 16 Ga Cold Rolled A1008 CS Type B (1.4mm)	

Color / Couleur: Asa-61 Grey	Finish / Fini: Smooth
Description: 5412ESCHW 16" x 14" x 6" Assembly	
Part Number / Numéro Pièce: 5412ESCHW161406	Rev. 0

PACKING		
ITEM	QTY	DESCRIPTION
STK-E-04328	1	CARTON 5412 ESCH161406
Plastic bag	1	To protect cover surface and inside gasket
Packaging label	1	White label with product number
STK-S-01100	1	ESCH EXM SQUARE STICKER

Qty	Part Number	Rev	Description
1	5412ESCHW161406C	0	5412ESCHW 16" x 14" Cover
1	880 SP1614G	0	880 SP1614G - Inner Panel
1	STK-K-02940	2	5412 ESCHB Accessory Kit
1	5412ESCHW161406B	0	5412ESCHW 16" x 14" x 6" Body
2	STK-Q-08100	1	M5 Nylon Insert Lock Nut
2	STK-Q-10249	0	M5 Sealing Washer

Parts List

This drawing is confidential and must not be reproduced or used without the consent of EXM

Ce dessin est confidentiel et ne doit pas être reproduit ou utilisé sans le consentement de EXM

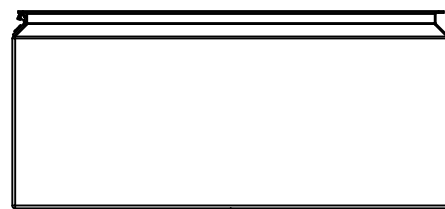

TOP



BACK

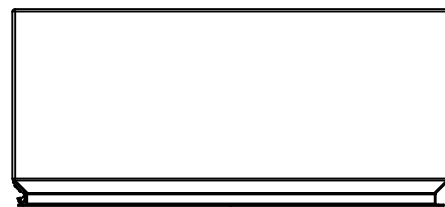

BOTTOM

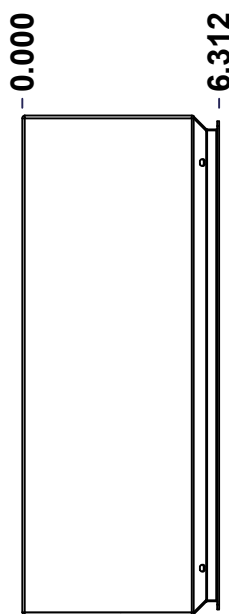

LEFT

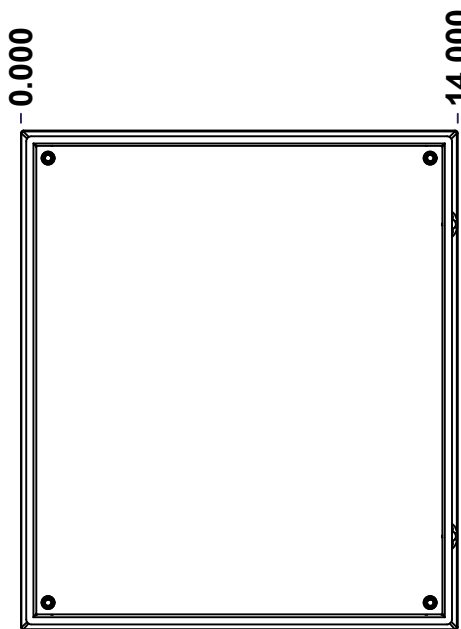

FRONT

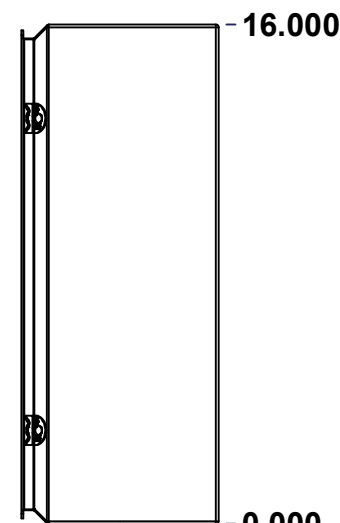

RIGHT

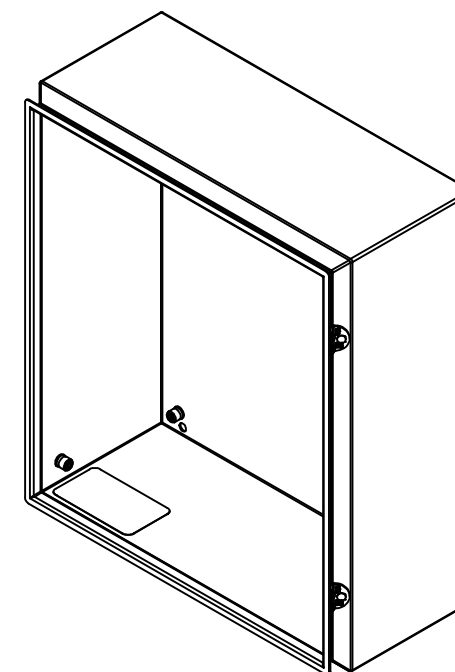

Isometric View



No.	Revisions	Date	By/Par

 Tél: (450) 979-4373
 Fax: (450) 979-4626
www.exmweb.com

Flatness / Aplatissement: Max 3.0mm
 Projection: 

Customer Client	Date
Drawn By / Dessiné Par: BoxCad: BoxCad	Date: 30-Apr-13
Material / Matière: 16 Ga Cold Rolled A1008 CS Type B (1.4mm)	

Color / Couleur: Asa-61 Grey	Finish / Fini: Smooth
------------------------------	-----------------------

Description: 5412ESCHW 16" x 14" x 6" Body	Detail Rev.
--	-------------

Part Number / Numéro Pièce: 5412ESCHW161406B	Rev. 0	3 / 10
---	--------	--------

SEE BILL OF MATERIAL ON LAST PAGE

This drawing is confidential and must not be reproduced or used without the consent of EXM

Ce dessin est confidentiel et ne doit pas être reproduit ou utilisé sans le consentement de EXM

STANDARD FEATURES ARE NOT LISTED IN THIS HOLE TABLE

HOLE TABLE - BOTTOM VIEW (CUSTOM FEATURE ONLY)

CUT-OUT	XDIM	YDIM	DESCRIPTION
1	2.000	4.250	LABEL_EXM

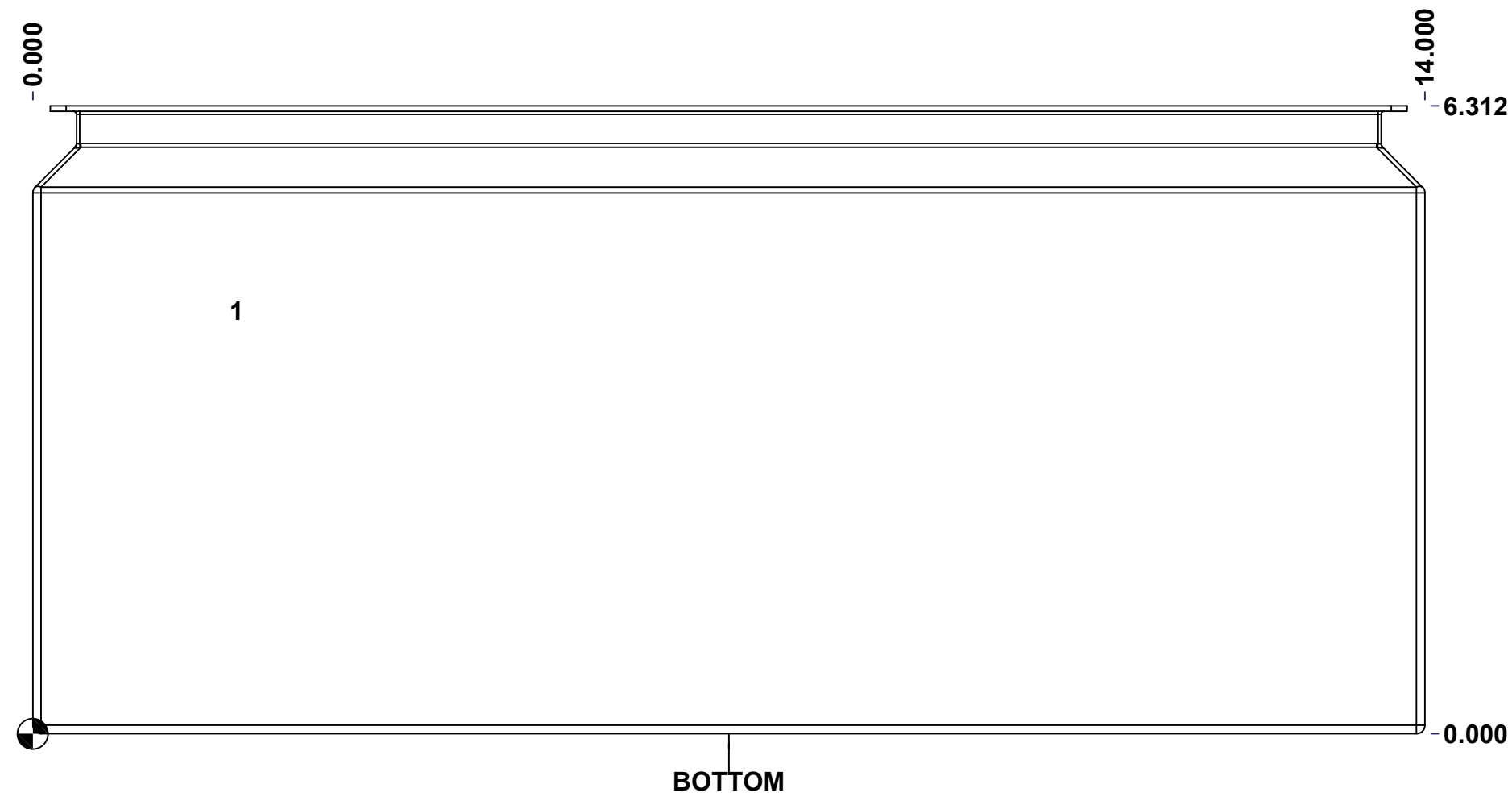

	Description		Status
	5412ESCHW 16" x 14" x 6" Body		(NULL)
Part Number Numéro Pièce		Rev.	4
5412ESCHW161406B		0	10

This drawing is confidential and must not be reproduced or used without the consent of EXM

Ce dessin est confidentiel et ne doit pas être reproduit ou utilisé sans le consentement de EXM

STANDARD FEATURES ARE NOT LISTED IN THIS HOLE TABLE			
HOLE TABLE - LEFT VIEW (CUSTOM FEATURE ONLY)			
CUT-OUT	XDIM	YDIM	DESCRIPTION
1	4.625	0.875	STANDOFF M6 x 10mm (Inside)

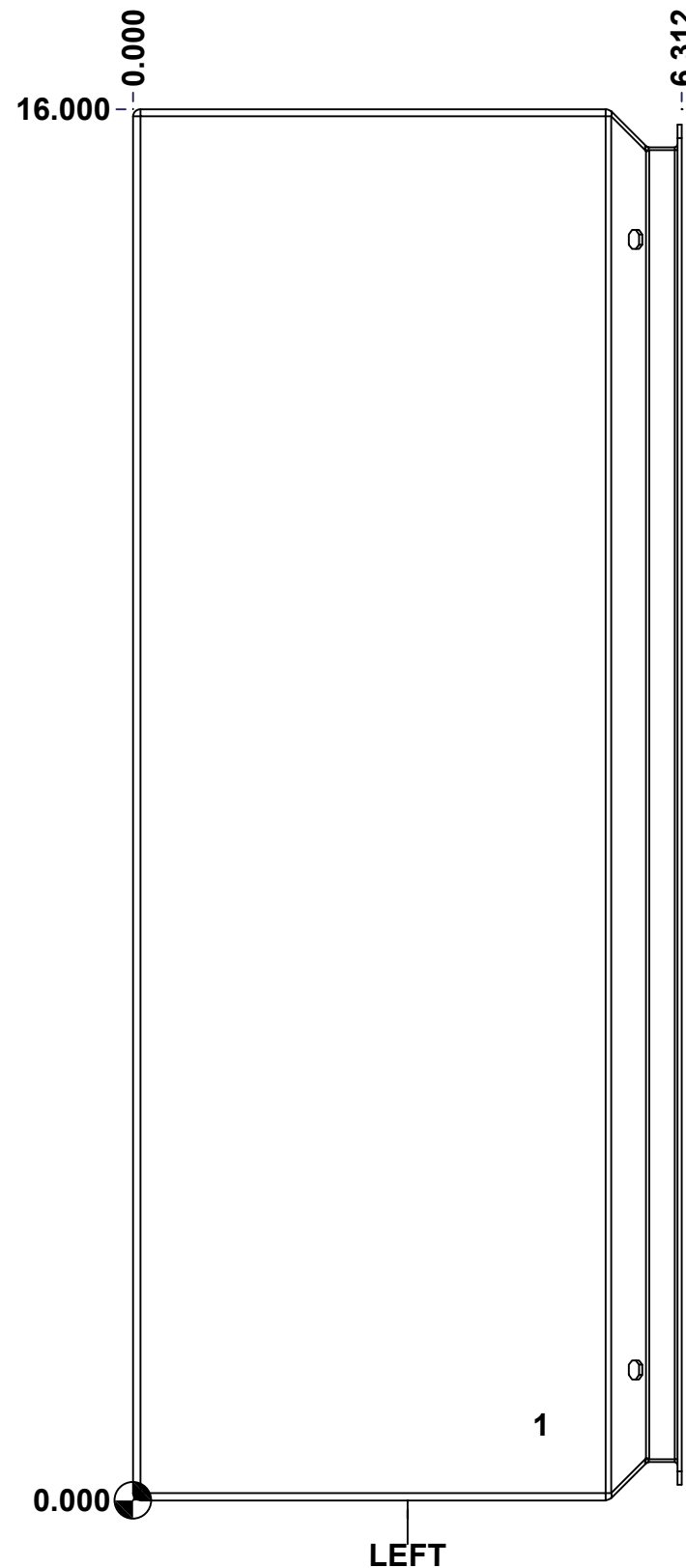

	Description	Status
	5412ESCHW 16" x 14" x 6" Body	(NULL)
Part Number Numéro Pièce	Rev.	5
	0	10
5412ESCHW161406B		

This drawing is confidential and must not be reproduced or used without the consent of EXM

Ce dessin est confidentiel et ne doit pas être reproduit ou utilisé sans le consentement de EXM

STANDARD FEATURES ARE NOT LISTED IN THIS HOLE TABLE

HOLE TABLE - BACK VIEW (CUSTOM FEATURE ONLY)

CUT-OUT	XDIM	YDIM	DESCRIPTION
1	0.875	0.875	IP STANDOFF M6 x 10mm (Inside)
2	0.875	15.125	IP STANDOFF M6 x 10mm (Inside)
3	13.125	15.125	IP STANDOFF M6 x 10mm (Inside)
4	13.125	0.875	IP STANDOFF M6 x 10mm (Inside)

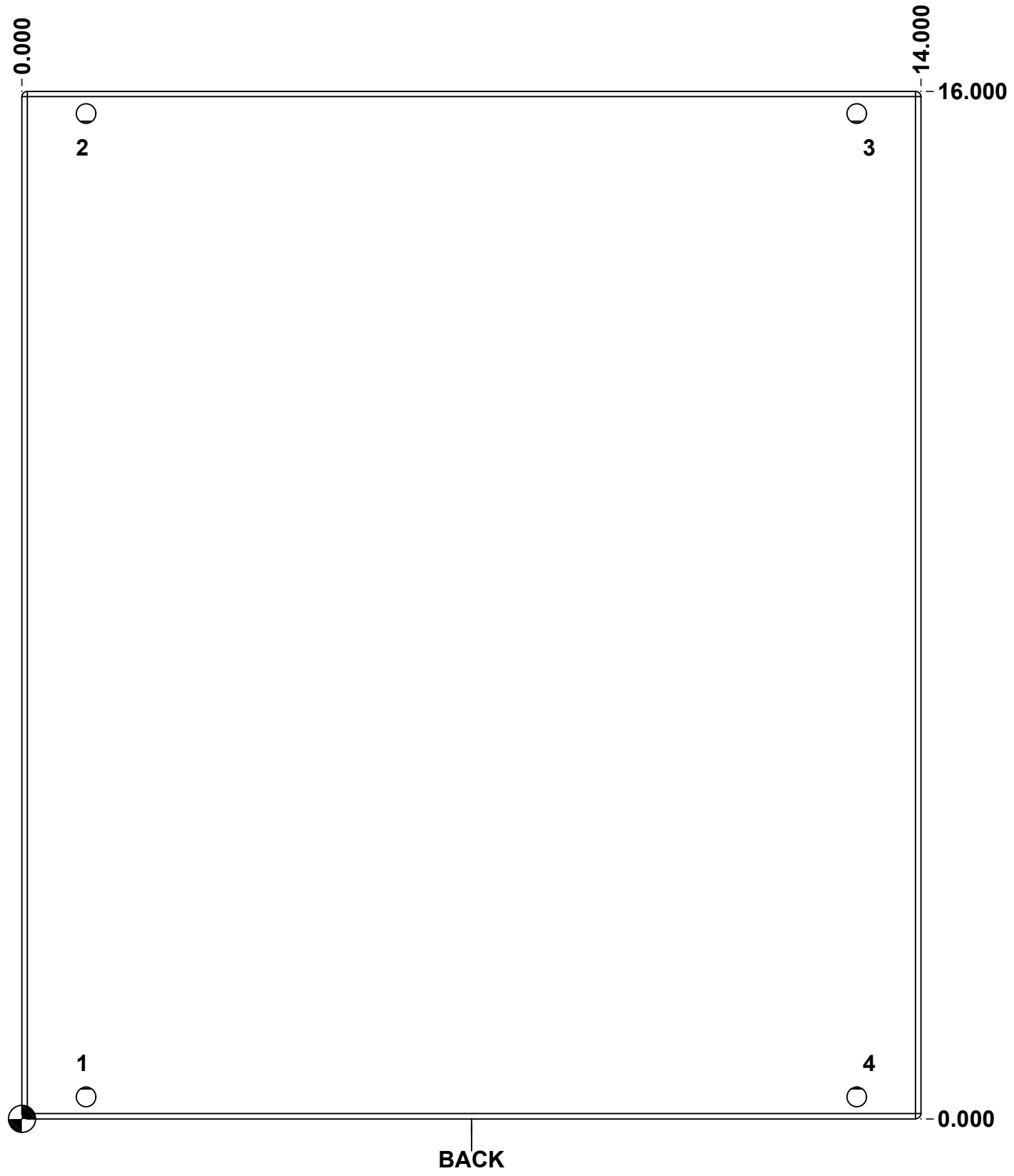

	Description	Status
	5412ESCHW 16" x 14" x 6" Body	(NULL)
	Part Number Numéro Pièce	Rev.
	5412ESCHW161406B	0 / 6
		10

This drawing is confidential and must not be reproduced or used without the consent of EXM

Ce dessin est confidentiel et ne doit pas être reproduit ou utilisé sans le consentement de EXM

No.	Revisions	Date	By/Par

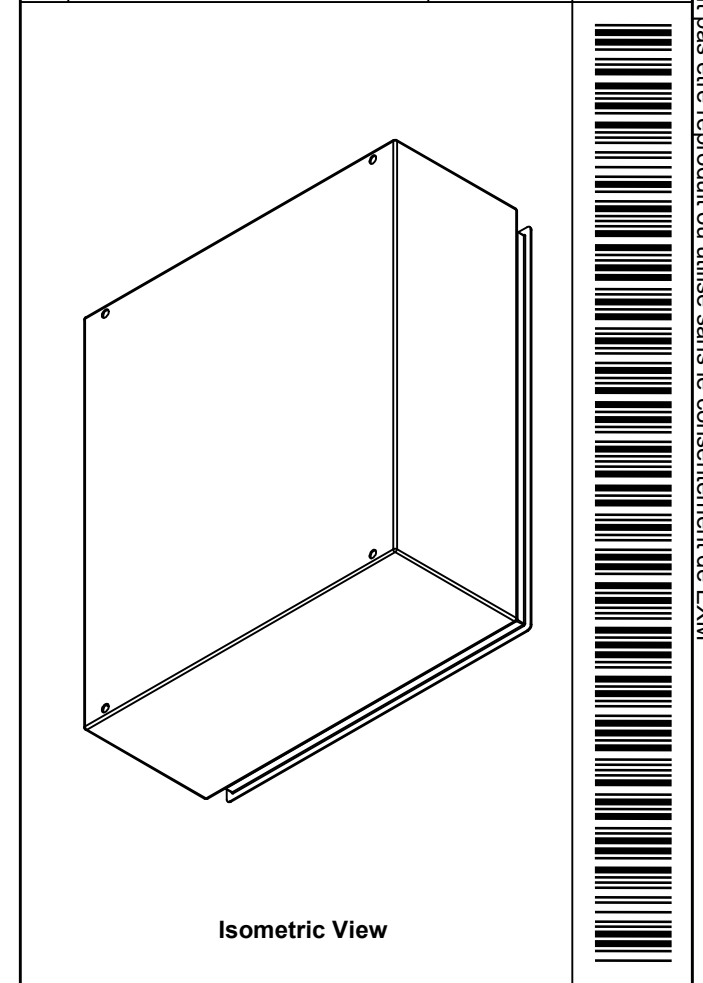

Tél: (450) 979-4373 Fax: (450) 979-4626 www.exmweb.com		Flatness Aplatissement	
		Max 3.0mm	
Customer Client		Date	
Drawn By Dessiné Par BoxCad: BoxCad		Date 30-Apr-13	
Material Matière 16 Ga Cold Rolled A1008 CS Type B (1.4mm)			
Color Couleur Asa-61 Grey		Finish Fini Smooth	
Description 5412ESCHW 16" x 14" x 6" Body			Detail Rev.
Part Number Numéro Pièce 5412ESCHW161406B		Rev. 0	7 / 10

Qty	Part Number	Rev	Description
1	STK-P-02400S	0	Powder Paint (Asa-61 Grey / Smooth)
1	5412ESCHW161406B-P	0	5412ESCHW 16" x 14" x 6" Body Part
1	STK-S-00100	0	3.5" x 2" Silver Milar Flexcon Sticker
2	STK-A-70469	6	5412 ESSMCH - Stainless Steel 316 Body Catch Assembly
2	STK-Q-08100	1	M5 Nylon Insert Lock Nut
5	STK-Q-08350	5	Standoff M6 x 10mm
Parts List			

This drawing is confidential and must not be reproduced or used without the consent of EXM

Ce dessin est confidentiel et ne doit pas être reproduit ou utilisé sans le consentement de EXM

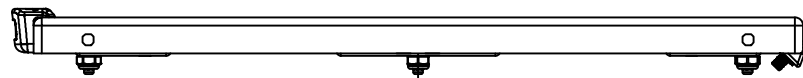

TOP

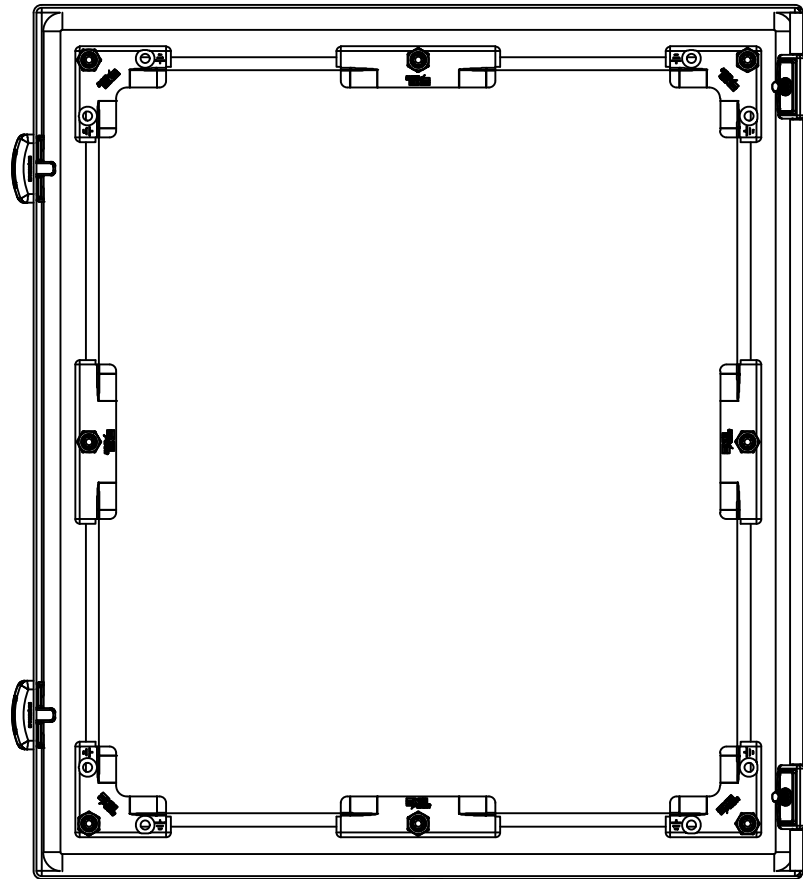

BACK

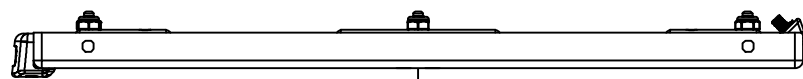

BOTTOM

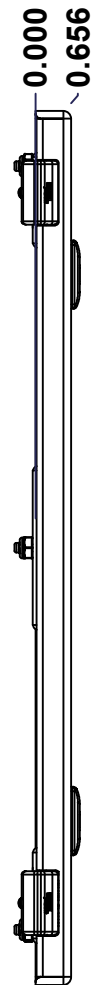

LEFT

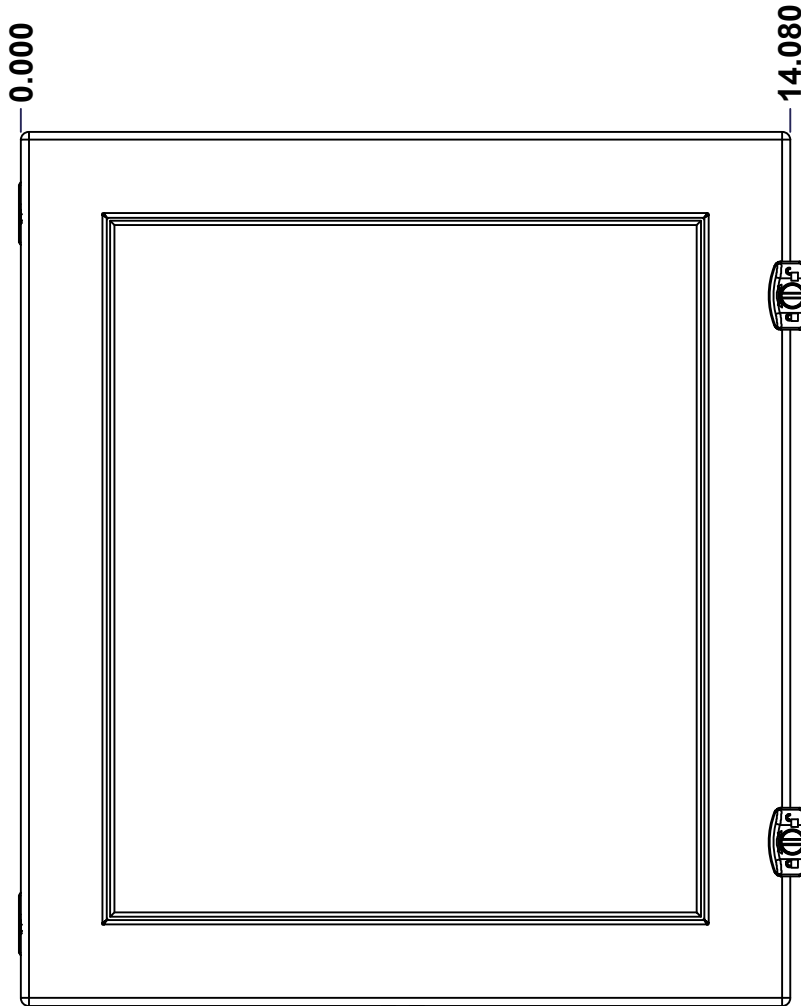

FRONT

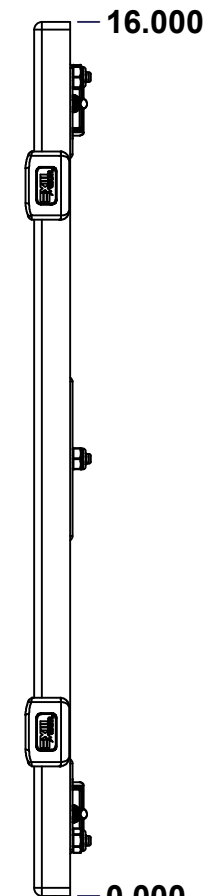

RIGHT

No.	Revisions	Date	By/Par

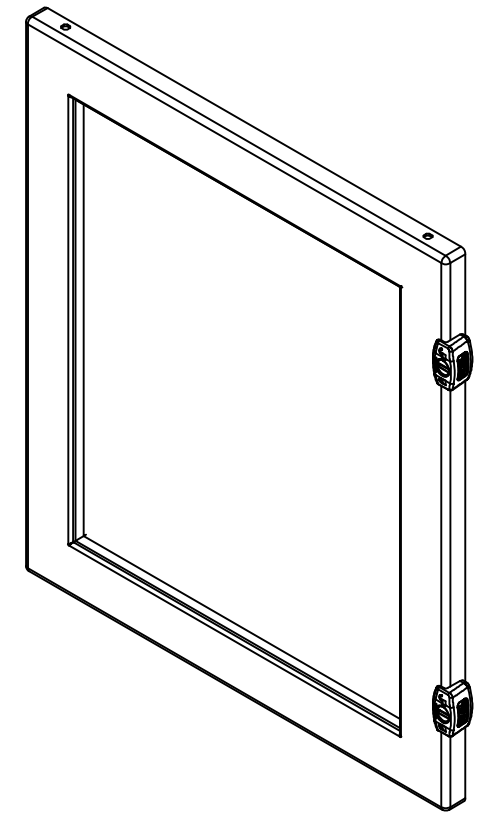

Isometric View



Tél: (450) 979-4373
 Fax: (450) 979-4626
www.exmweb.com

Flatness
Aplatissement

Max 3.0mm

Projection

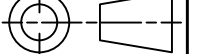

Customer Client	Date
Drawn By / Dessiné Par: BoxCad: BoxCad	Date: 30-Apr-13

Material / Matière: 16 Ga Cold Rolled A1008 CS Type B (1.4mm)

Color / Couleur: Asa-61 Grey	Finish / Fini: Smooth
------------------------------	-----------------------

Description: 5412ESCHW 16" x 14" Cover	Detail Rev.
--	-------------

Part Number / Numéro Pièce: 5412ESCHW161406C	Rev. 0	8	10
--	--------	---	----

SEE BILL OF MATERIAL ON LAST PAGE

This drawing is confidential and must not be reproduced or used without the consent of EXM

Ce dessin est confidentiel et ne doit pas être reproduit ou utilisé sans le consentement de EXM

STANDARD FEATURES ARE NOT LISTED IN THIS HOLE TABLE			
HOLE TABLE - FRONT VIEW (CUSTOM FEATURE ONLY)			
CUT-OUT	XDIM	YDIM	DESCRIPTION
1	14.080	3.000	LOCK 880 SCQ2MS @ 0.0°
2	14.080	13.000	LOCK 880 SCQ2MS @ 0.0°

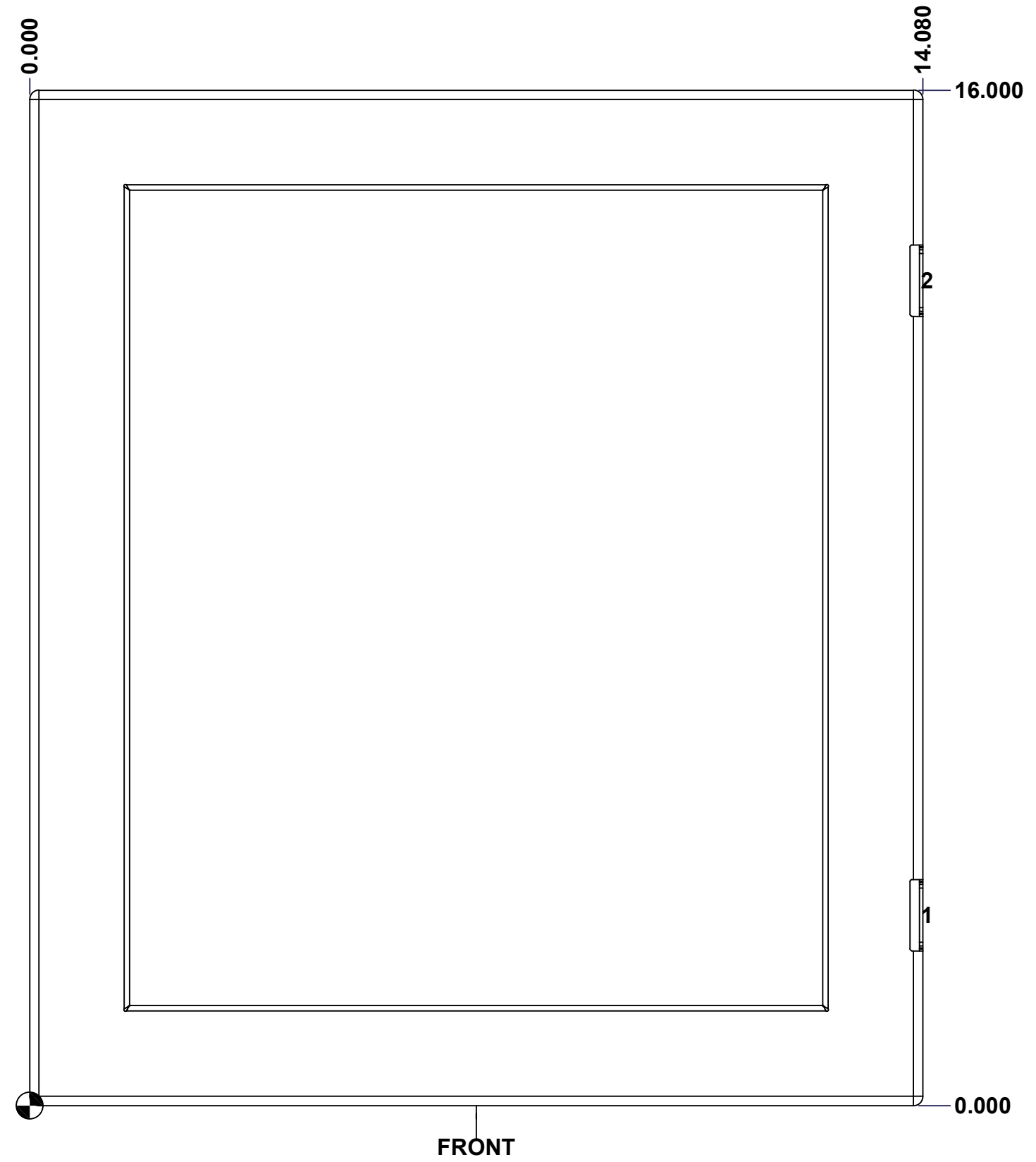

	Description	Status
	5412ESCHW 16" x 14" Cover	(NULL)
Part Number Numéro Pièce 5412ESCHW161406C	Rev.	9
	0	10

This drawing is confidential and must not be reproduced or used without the consent of EXM

Ce dessin est confidentiel et ne doit pas être reproduit ou utilisé sans le consentement de EXM

No.	Revisions	Date	By/Par

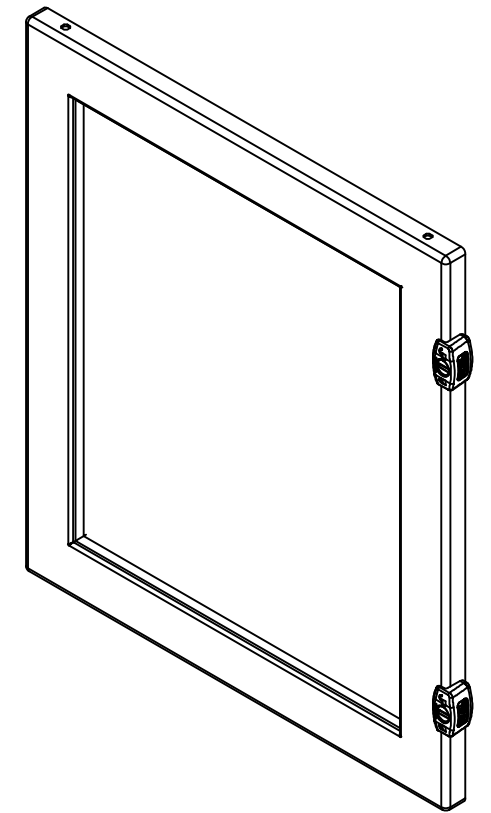

Isometric View

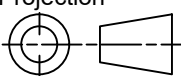

1	STK-P-02400S	0	Powder Paint (Asa-61 Grey / Smooth)
4	STK-Q-60701	2.1	880 WK - Lexan 1/4" Fixing Bracket
1	STK-G-02705	0	880 HWKG - Windows Kit Gasket
1	5412ESCHW161406G	0	5412ESCHW 16" x 14" Gasket
1	5412ESCHW161406LXG	0	5412ESCHW 16" x 14" Lexan Gasket
1	5412ESCHW161406LX	0	5412ESCHW Lexan 13.6" x 11.68" x 1/4"
8	STK-Q-16052	0	M6 x 23mm Stud (No Paint Cap Required)
1	5412ESCHW161406C-P	0	5412ESCHW 16" x 14" Cover Part
2	STK-A-33033	4	5412 ESMCH Hinge
2	880SCQ2MS	3	5412 ESMCH - External Lock Assy - Slot Lock
4	STK-Q-60703	1	Lexan Coner Grounding Bracket
Qty	Part Number	Rev	Description
Parts List			

 Tél: (450) 979-4373 Fax: (450) 979-4626 www.exmweb.com	Flatness Aplatissement	Max 3.0mm
	Projection	
Customer Client	Date	
Drawn By Dessiné Par	BoxCad: BoxCad	Date 30-Apr-13
Material Matière	16 Ga Cold Rolled A1008 CS Type B (1.4mm)	
Color Couleur	Asa-61 Grey	Finish Fini Smooth
Description	Detail Rev.	
5412ESCHW 16" x 14" Cover		
Part Number Numéro Pièce	Rev.	10
5412ESCHW161406C	0	10

This drawing is confidential and must not be reproduced or used without the consent of EXM

Ce dessin est confidentiel et ne doit pas être reproduit ou utilisé sans le consentement de EXM

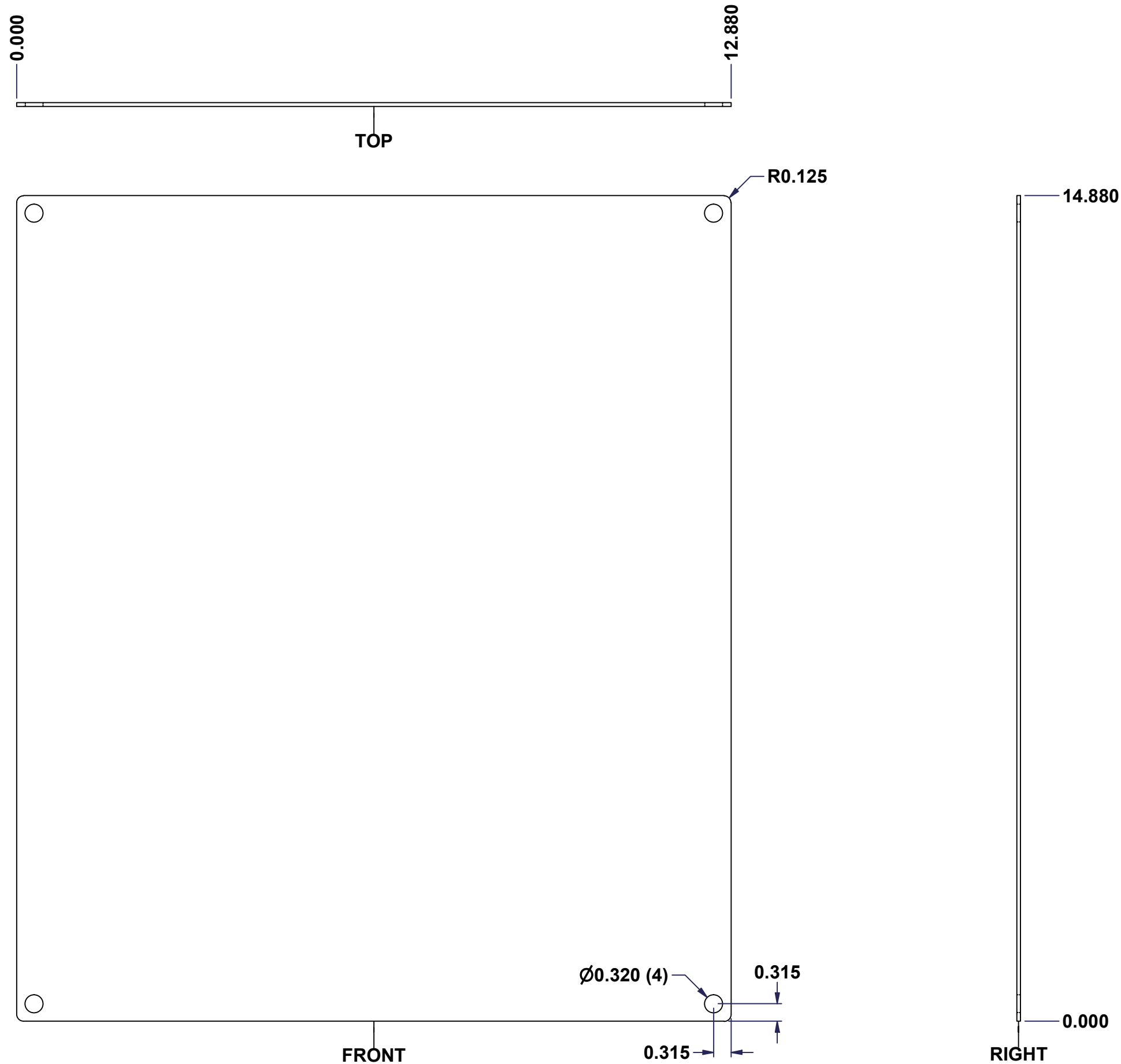

No.	Revisions	Date	By/Par

Isometric View

Tél: (450) 979-4373 Fax: (450) 979-4626 www.exmweb.com		Flatness Aplatissement
		Max 3.0mm
Customer Client Drawn By / Dessiné Par: BoxCad Material / Matière: 14 Ga Galvanized (1.7mm)		Projection
Date		Date
Date 23-Jan-07		Date
Color / Couleur: Unpainted	Finish / Fini: Galvanized	Detail Rev.
Description: 880 SP1614G - Inner Panel		Detail Rev.
Part Number / Numéro Pièce: 880 SP1614G	Rev. 0	1 / 2

SEE BILL OF MATERIAL ON LAST PAGE

This drawing is confidential and must not be reproduced or used without the consent of EXM

Ce dessin est confidentiel et ne doit pas être reproduit ou utilisé sans le consentement de EXM

No.	Revisions	Date	By/Par

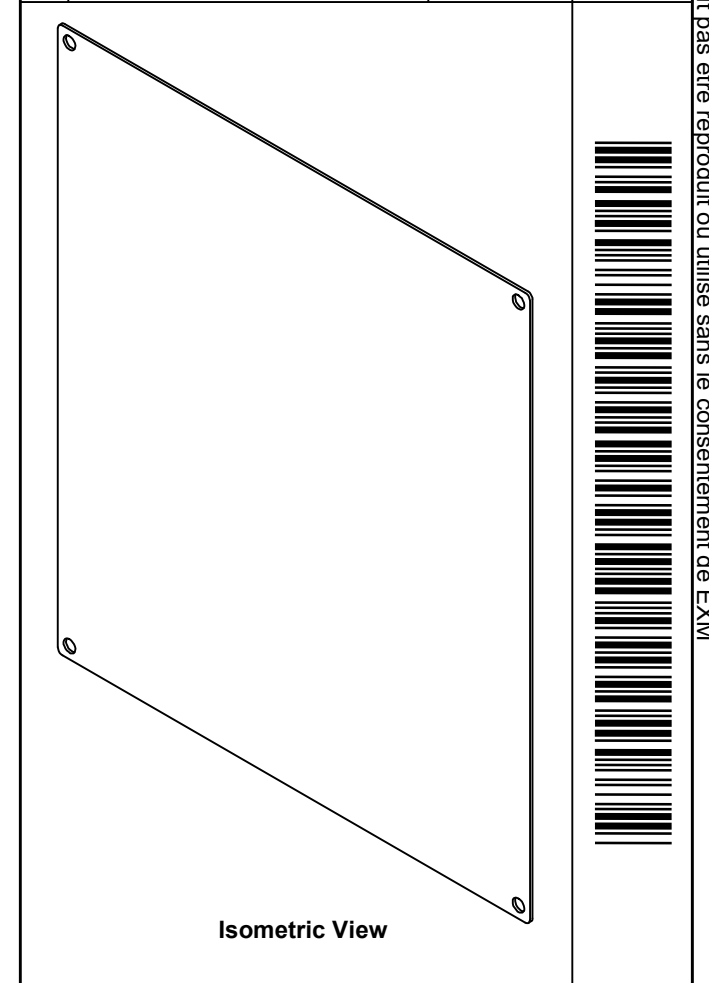

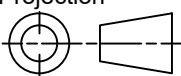
 Tél: (450) 979-4373 Fax: (450) 979-4626 www.exmweb.com		Flatness Aplatissement Max 3.0mm
Customer Client		Projection 
Drawn By / Dessiné Par: BoxCad		Date: 23-Jan-07
Material / Matière: 14 Ga Galvanized (1.7mm)		
Color / Couleur: Unpainted	Finish / Fini: Galvanized	
Description: 880 SP1614G - Inner Panel		Detail Rev.
Part Number / Numéro Pièce: 880 SP1614G		Rev. 0 / 2

Qty	Part Number	Rev	Description
1	880 SP1614G-P	0	880 SP1614G - Inner Panel Part
Parts List			