

This drawing is confidential and must not be reproduced or used without the consent of EXM

Ce dessin est confidentiel et ne doit pas être reproduit ou utilisé sans le consentement de EXM

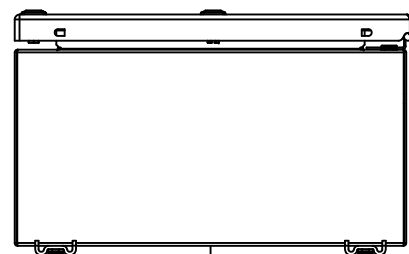

TOP

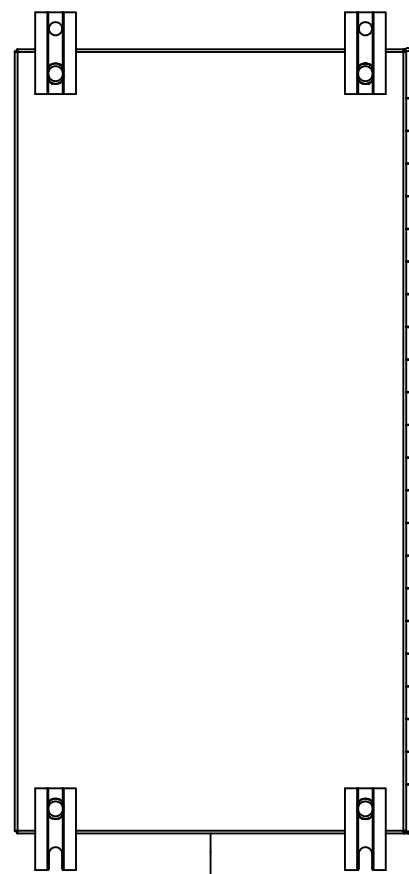

BACK

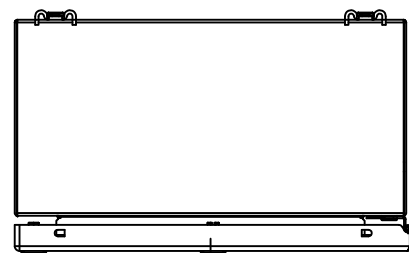

BOTTOM

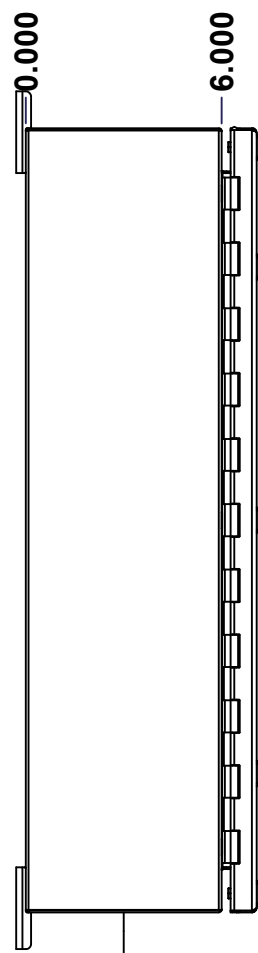

LEFT

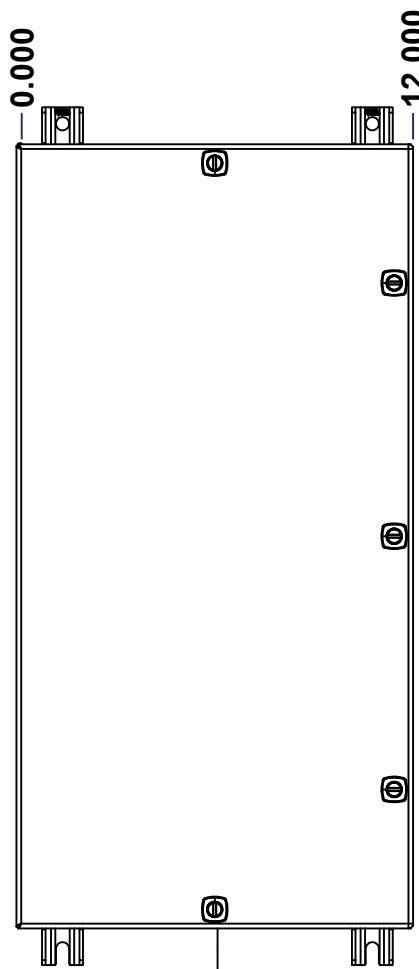

FRONT

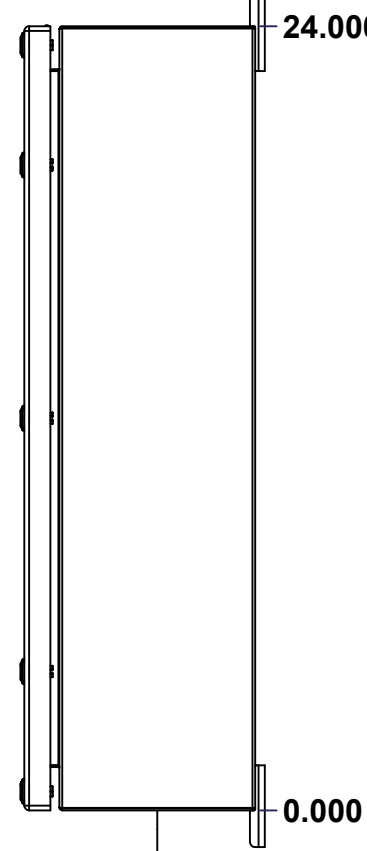

RIGHT

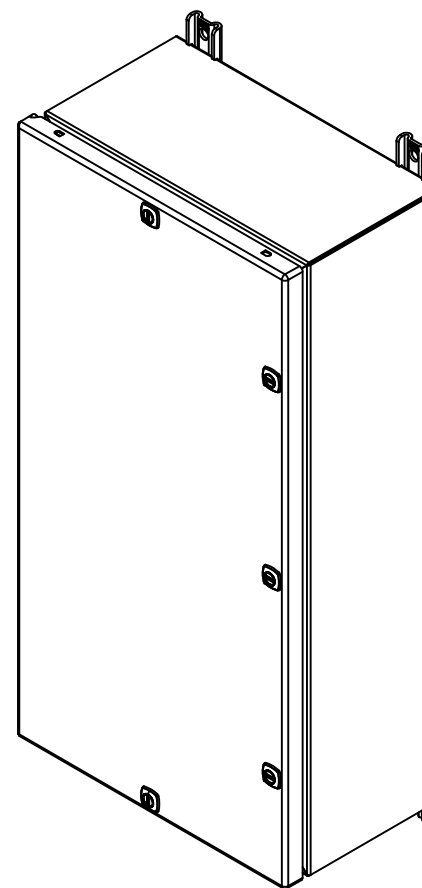

Isometric View

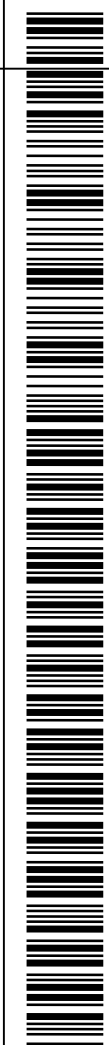

No.	Revisions	Date	By/Par

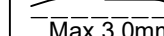
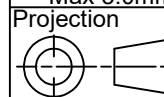
 Tél: (450) 979-4373 Fax: (450) 979-4626 www.exmweb.com		Flatness Aplatissement  Max 3.0mm Projection 
Customer Client	Date	
Drawn By Dessiné Par	BoxCad: BoxCad	Date 16-Jan-20
Material Matière	16 Ga H.R.P. & O. (1.4mm)	
Color Couleur	Asa-61 Grey	Finish Fini Smooth
Description	Detail Rev.	
5412ESEL 24" x 12" x 6" Assembly		
Part Number Numéro Pièce	Rev.	1
5412ESEL241206_mc	0	2

SEE BILL OF MATERIAL ON LAST PAGE



This drawing is confidential and must not be reproduced or used without the consent of EXM

Ce dessin est confidentiel et ne doit pas être reproduit ou utilisé sans le consentement de EXM

NOTE	
ITEM	DESCRIPTION
1	NEMA 4/12 Enclosure
2	C/W Standard ground studs on box and cover
3	W/O Standard door stiffener
4	C/W Standard inner panel (Sold separately)
5	C/W Standard inner panel mounting studs
6	C/W 885 ESMF1_OPEN Sold separately (Kit)
7	C/W 885 ESMF1_CLOSE Sold separately (Kit)

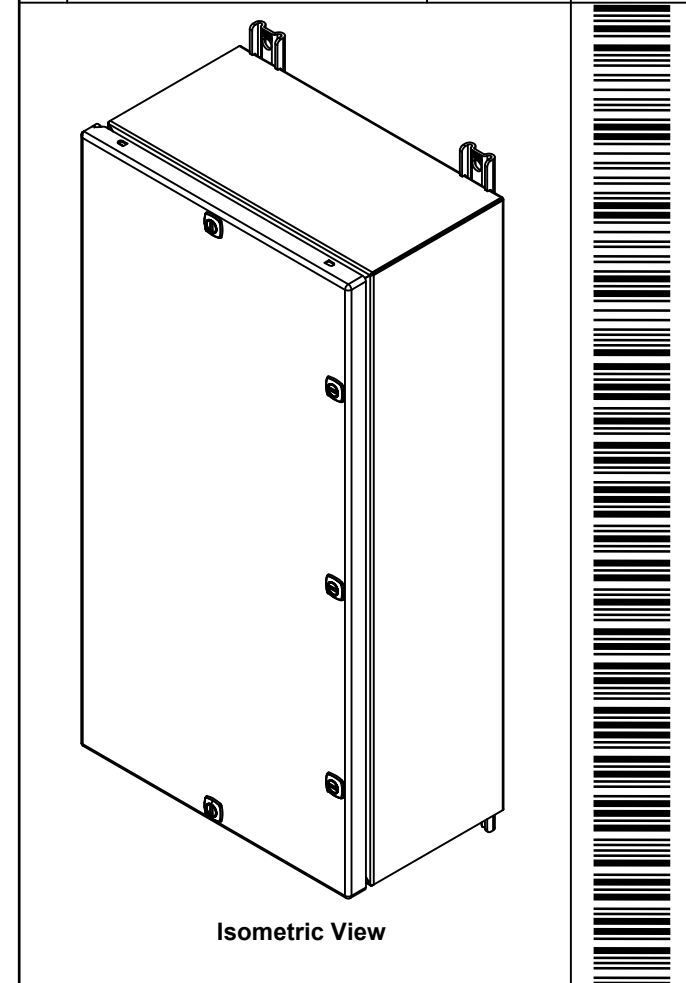
No.	Revisions	Date	By/Par

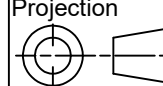

 Tél: (450) 979-4373 Fax: (450) 979-4626 www.exmweb.com		Flatness Aplatissement  Max 3.0mm Projection 
Customer Client	Date	
Drawn By Dessiné Par	BoxCad: BoxCad	Date 16-Jan-20
Material Matière	16 Ga H.R.P. & O. (1.4mm)	
Color Couleur	Asa-61 Grey	Finish Fini Smooth
Description	Detail Rev.	
5412ESEL 24" x 12" x 6" Assembly		
Part Number Numéro Pièce	5412ESEL241206_mc	Rev. 0

PACKING		
ITEM	QTY	DESCRIPTION
Cardboard sleeve	2	Top and Bottom
Cardboard strip	2	Between back of enclosure and inner panel
Plastic bag	1	To protect cover surface and inside gasket
Plastic strap - Black	2	To Squeeze the 2 cardboard sleeve together
Packaging label	1	White label with product number

Qty	Part Number	Rev	Description
1	STK-K-01800	5	5412 ES Accessory Kit
1	885SP2412G	0	885SP 24" x 12" Inner Panel Part
1	5412ESEL241206_mcC	0	5412ESEL 24" x 12" Cover
4	STK-Q-07310	2	Flange Lock Nut M8
4	STK-Q-07610	8	M8 Plastic Spacer 22.2mm
1	5412ESEL241206_mcB	0	5412ESEL 24" x 12" x 6" Body
3	STK-Q-04050-10	8	M6 x 10mm Hexagon Socket Head Machine Screw with Nyseal
Parts List			

This drawing is confidential and must not be reproduced or used without the consent of EXM

Ce dessin est confidentiel et ne doit pas être reproduit ou utilisé sans le consentement de EXM

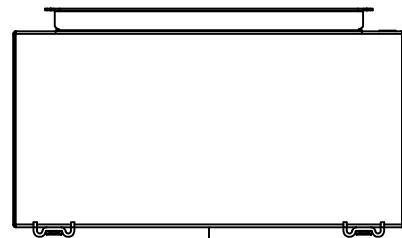

TOP

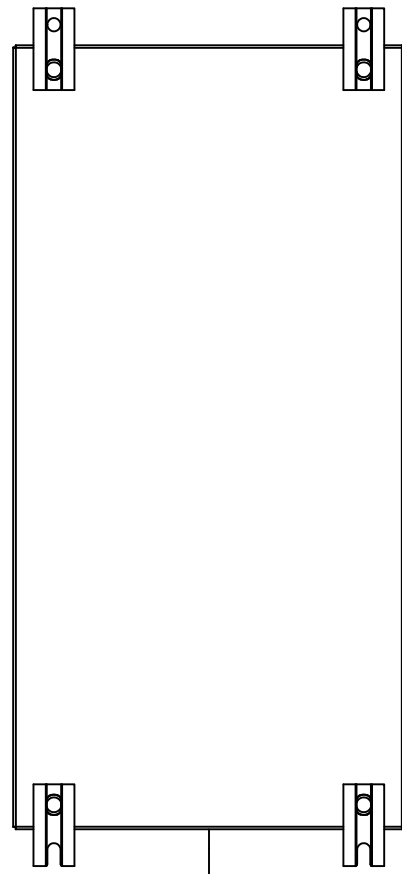

BACK

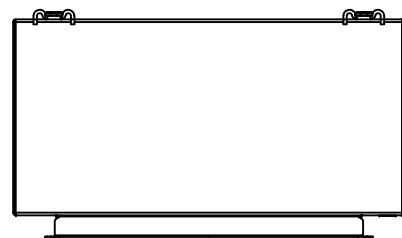

BOTTOM

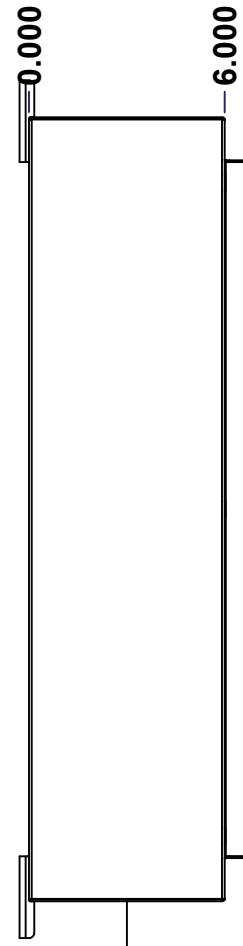

LEFT

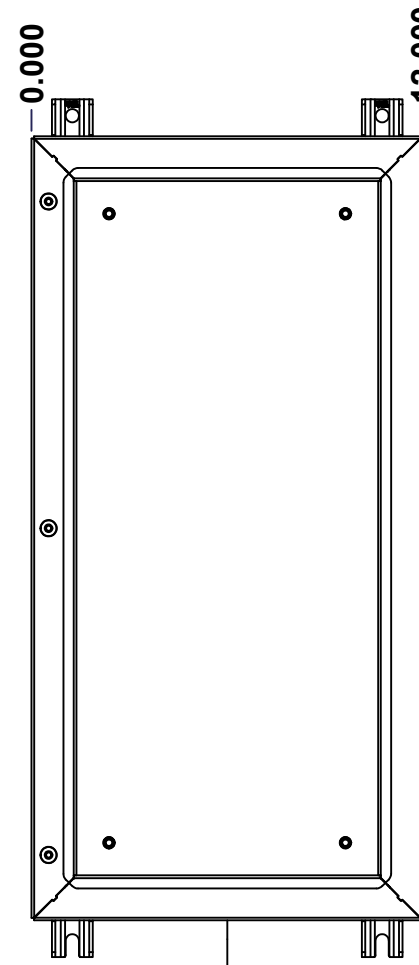

FRONT

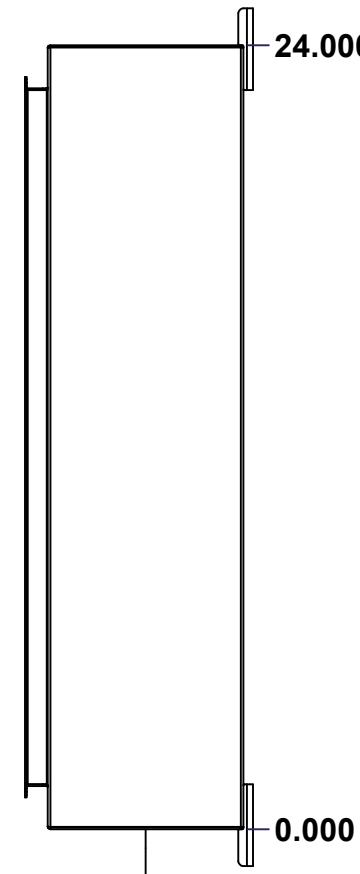

RIGHT

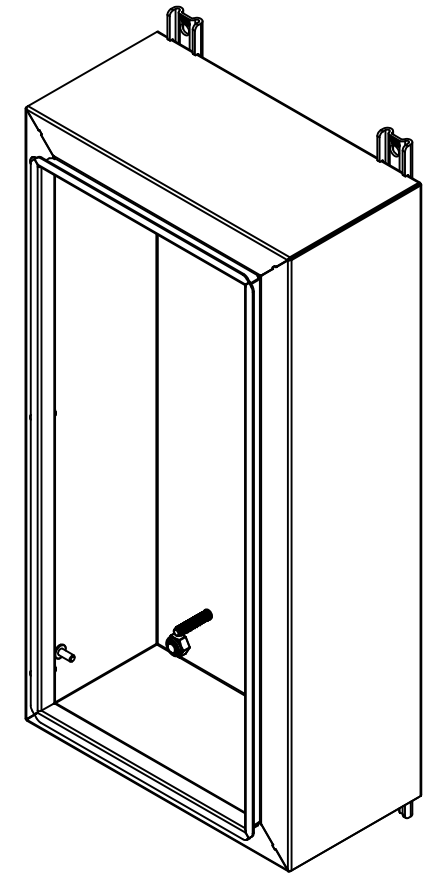

Isometric View

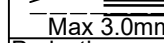
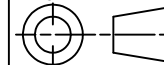

No.	Revisions	Date	By/Par

 Tél: (450) 979-4373 Fax: (450) 979-4626 www.exmweb.com		Flatness Aplatissement  Max 3.0mm Projection 
Customer Client	Date	
Drawn By Dessiné Par	BoxCad: BoxCad	Date 16-Jan-20
Material Matière	16 Ga H.R.P. & O. (1.4mm)	
Color Couleur	Asa-61 Grey	Finish Fini Smooth
Description	Detail Rev.	
5412ESEL 24" x 12" x 6" Body		
Part Number Numéro Pièce	Rev.	1 / 7
5412ESEL241206_mcB	0	

SEE BILL OF MATERIAL ON LAST PAGE

This drawing is confidential and must not be reproduced or used without the consent of EXM

Ce dessin est confidentiel et ne doit pas être reproduit ou utilisé sans le consentement de EXM

STANDARD FEATURES ARE NOT LISTED IN THIS HOLE TABLE			
HOLE TABLE - LEFT VIEW (CUSTOM FEATURE ONLY)			
CUT-OUT	XDIM	YDIM	DESCRIPTION
1	4.500	2.000	GND STUD M6 x 16mm (Inside)

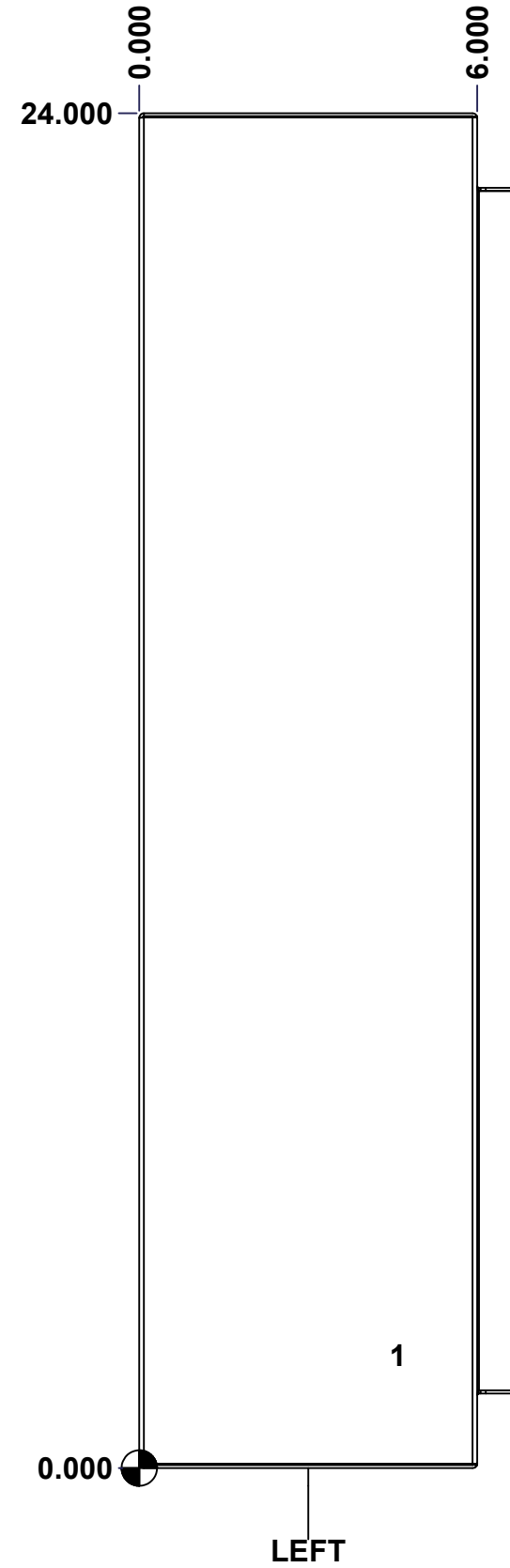

	Description		Status	
	5412ESEL 24" x 12" x 6" Body			
Part Number Numéro Pièce		Rev.	5 / 7	
5412ESEL241206_mcB		0		

This drawing is confidential and must not be reproduced or used without the consent of EXM

Ce dessin est confidentiel et ne doit pas être reproduit ou utilisé sans le consentement de EXM

STANDARD FEATURES ARE NOT LISTED IN THIS HOLE TABLE

HOLE TABLE - BACK VIEW (CUSTOM FEATURE ONLY)

CUT-OUT	XDIM	YDIM	DESCRIPTION
1	2.375	2.375	IP STUD M8 x 35mm (Inside)
2	2.375	21.625	IP STUD M8 x 35mm (Inside)
3	9.625	21.625	IP STUD M8 x 35mm (Inside)
4	9.625	2.375	IP STUD M8 x 35mm (Inside)

5	10.750	0.000	FOOT 885 ESMF1_OPEN
6	1.250	0.000	FOOT 885 ESMF1_OPEN
7	10.750	24.000	FOOT 885 ESMF1_CLOSE
8	1.250	24.000	FOOT 885 ESMF1_CLOSE

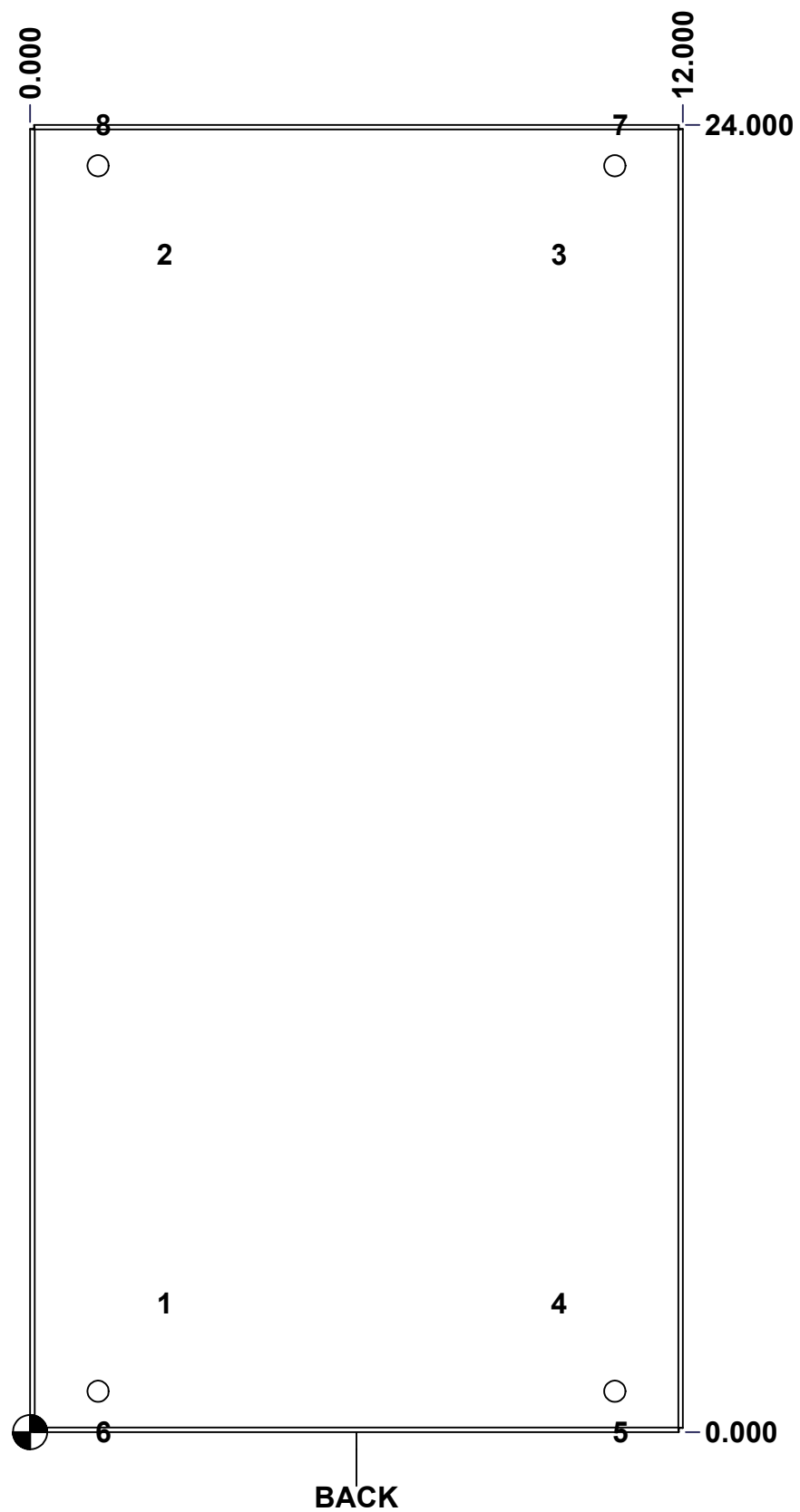

	Description	Status
	5412ESEL 24" x 12" x 6" Body	
	Part Number Numéro Pièce	Rev.
	5412ESEL241206_mcB	0
		6
		7

This drawing is confidential and must not be reproduced or used without the consent of EXM

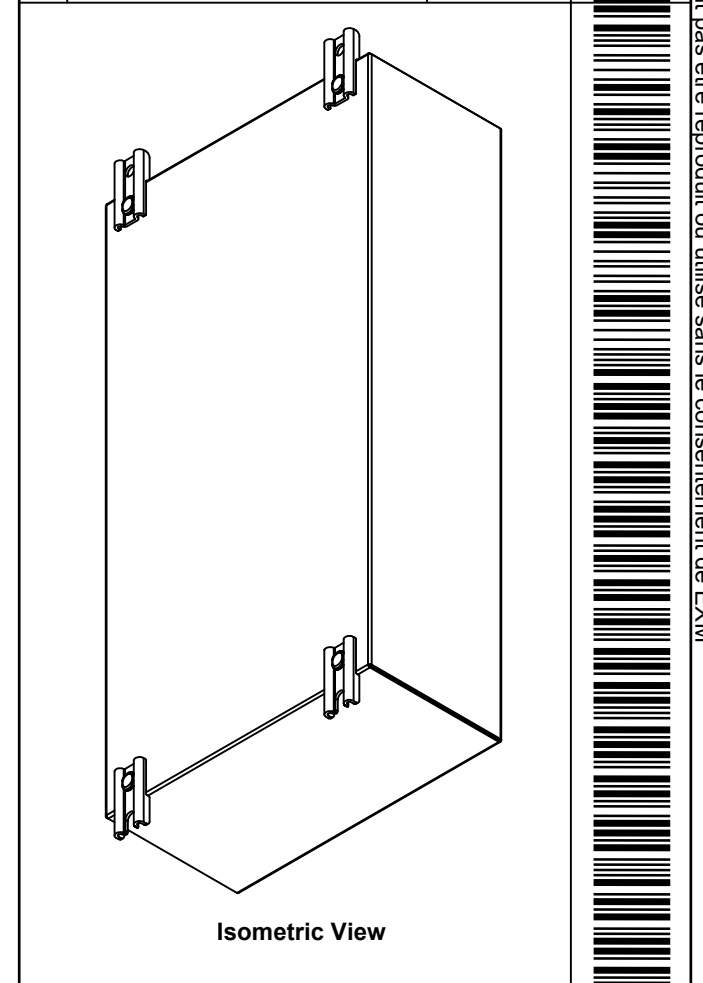

Ce dessin est confidentiel et ne doit pas être reproduit ou utilisé sans le consentement de EXM

No.	Revisions	Date	By/Par



Qty	Part Number	Rev	Description
1	STK-Q-16080	0	Ground Stud M6 x 16mm
3	RIVET_NUT_SS_M6_FH_CE	0	Stainless Steel Rivet Nut M6 (Low Profile Close End)
1	STK-P-02400S	0	Powder Paint (Asa-61 Grey / Smooth)
4	STK-Q-16005	1	Stud M8 x 35 (No Paint Cap Required)
1	5412ESEL241206_mcB-P	0	5412ESEL 24" x 12" x 6" Body Part
2	885 ESMF1_CLOSE	0	885 ESMF1 Mounting Foot (Closed Hole)
2	885 ESMF1_OPEN	0	885 ESMF1 Mounting Foot (Opened Hole)

Parts List

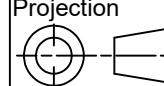
 Tél: (450) 979-4373 Fax: (450) 979-4626 www.exmweb.com		Flatness Aplatissement  Max 3.0mm
Customer Client Drawn By / Dessiné Par: BoxCad: BoxCad		Date: 16-Jan-20 
Material / Matière: 16 Ga H.R.P. & O. (1.4mm)		Finish / Fini: Smooth
Color / Couleur: Asa-61 Grey		Detail Rev.
Description: 5412ESEL 24" x 12" x 6" Body		Part Number / Numéro Pièce: 5412ESEL241206_mcB
Rev. 0		7 / 7

This drawing is confidential and must not be reproduced or used without the consent of EXM

Ce dessin est confidentiel et ne doit pas être reproduit ou utilisé sans le consentement de EXM

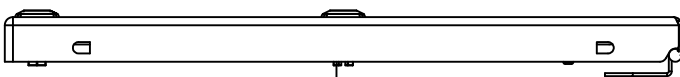

TOP

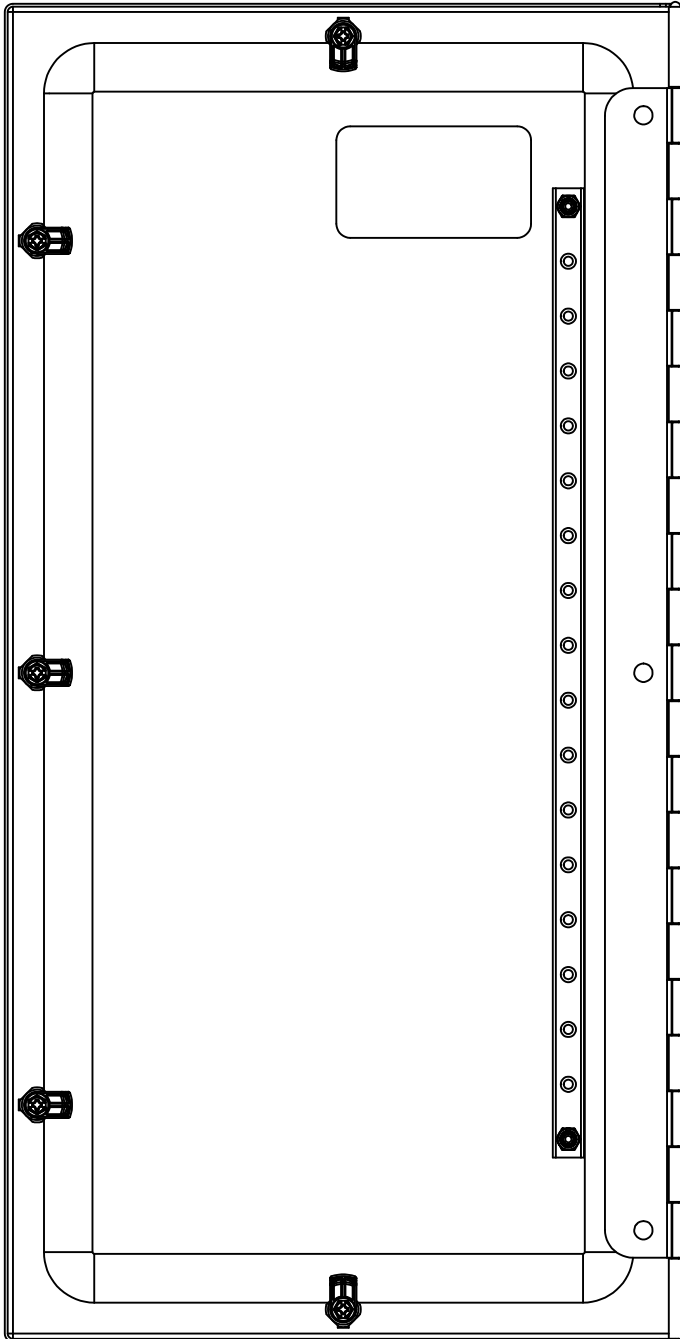

BACK

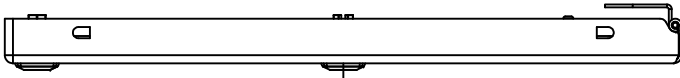

BOTTOM

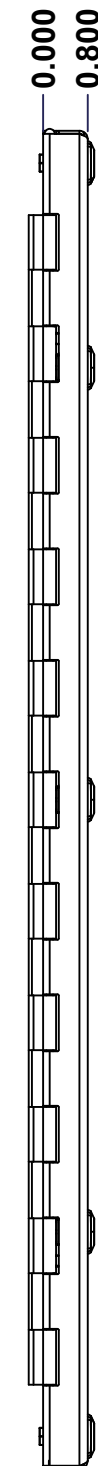

LEFT

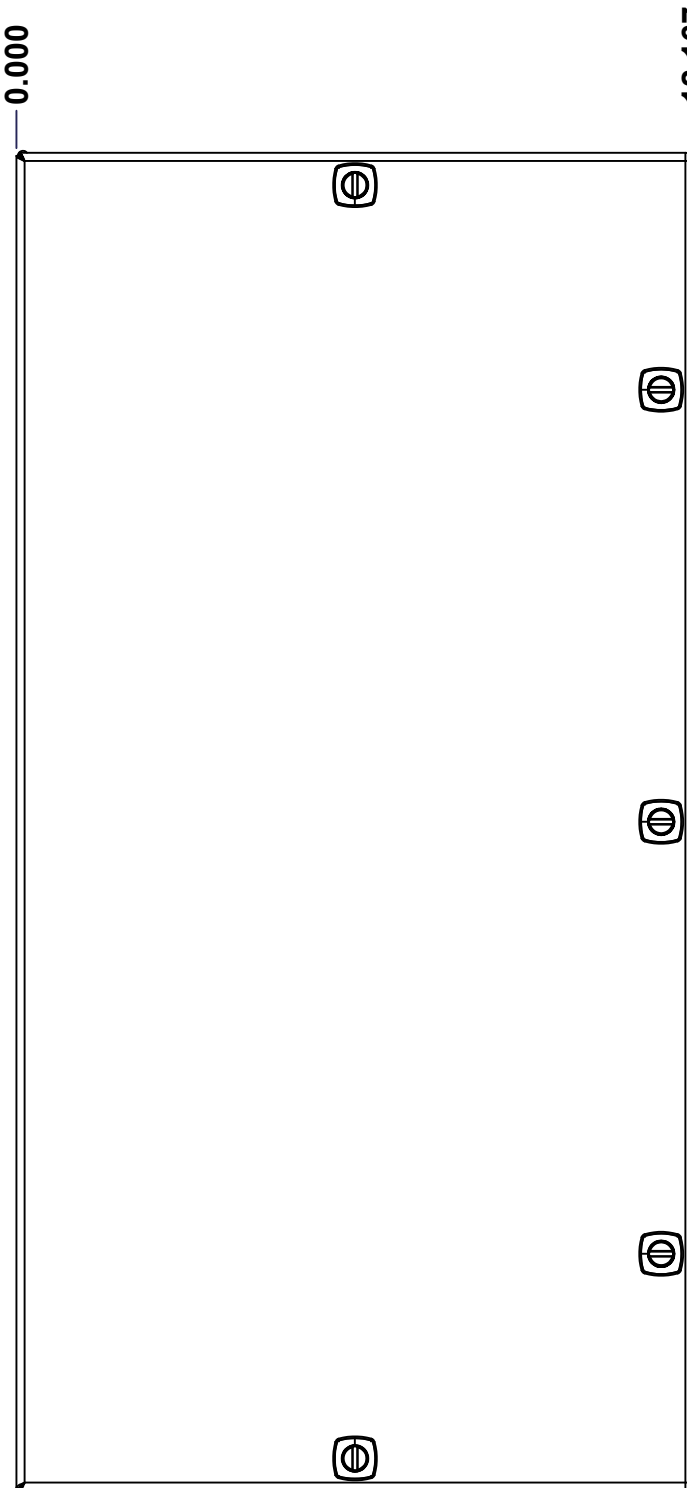

FRONT

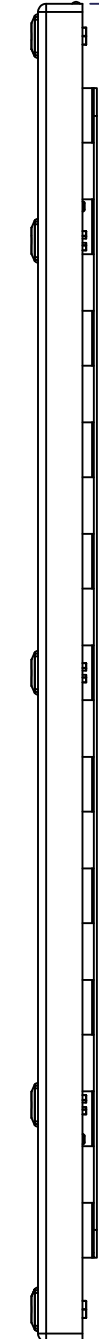

RIGHT

0.000
0.800

0.000

12.167

24.000

0.000

No.	Revisions	Date	By/Par

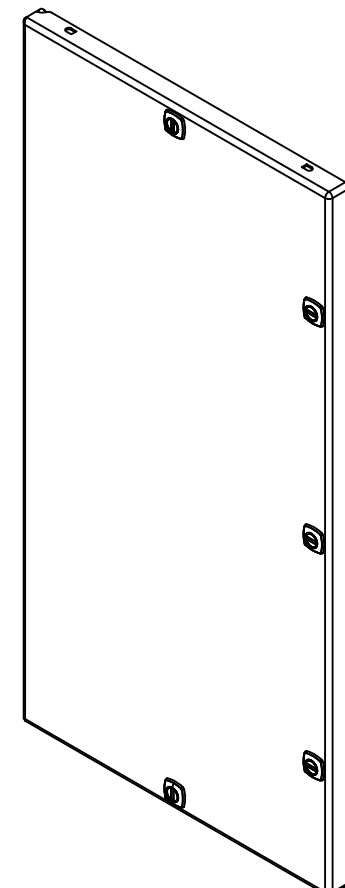

Isometric View



Tél: (450) 979-4373
Fax: (450) 979-4626
www.exmweb.com

Flatness
Aplatissement
Max 3.0mm
Projection

Customer Client
Date
Drawn By Dessiné Par BoxCad: BoxCad
Date 16-Jan-20
Material Matière 16 Ga H.R.P. & O. (1.4mm)

Color Couleur Asa-61 Grey
Finish Fini Smooth

Description 5412ESEL 24" x 12" Cover
Detail Rev.

Part Number Numéro Pièce 5412ESEL241206_mcC
Rev. 0
1
3

SEE BILL OF MATERIAL ON LAST PAGE

This drawing is confidential and must not be reproduced or used without the consent of EXM

Ce dessin est confidentiel et ne doit pas être reproduit ou utilisé sans le consentement de EXM

STANDARD FEATURES ARE NOT LISTED IN THIS HOLE TABLE

HOLE TABLE - FRONT VIEW (CUSTOM FEATURE ONLY)

CUT-OUT	XDIM	YDIM	DESCRIPTION
1	2.122	3.634	STUD M6 x 18mm (Inside)
2	2.122	20.366	STUD M6 x 18mm (Inside)

3	11.587	4.250	LOCK 880 SCQ5-SL @ 180.0°
4	6.084	23.420	LOCK 880 SCQ5-SL @ 270.0°
5	6.084	0.580	LOCK 880 SCQ5-SL @ 90.0°
6	11.587	12.000	LOCK 880 SCQ5-SL @ 180.0°
7	4.458	20.803	LABEL_EXM (Inside)
8	11.587	19.750	LOCK 880 SCQ5-SL @ 180.0°

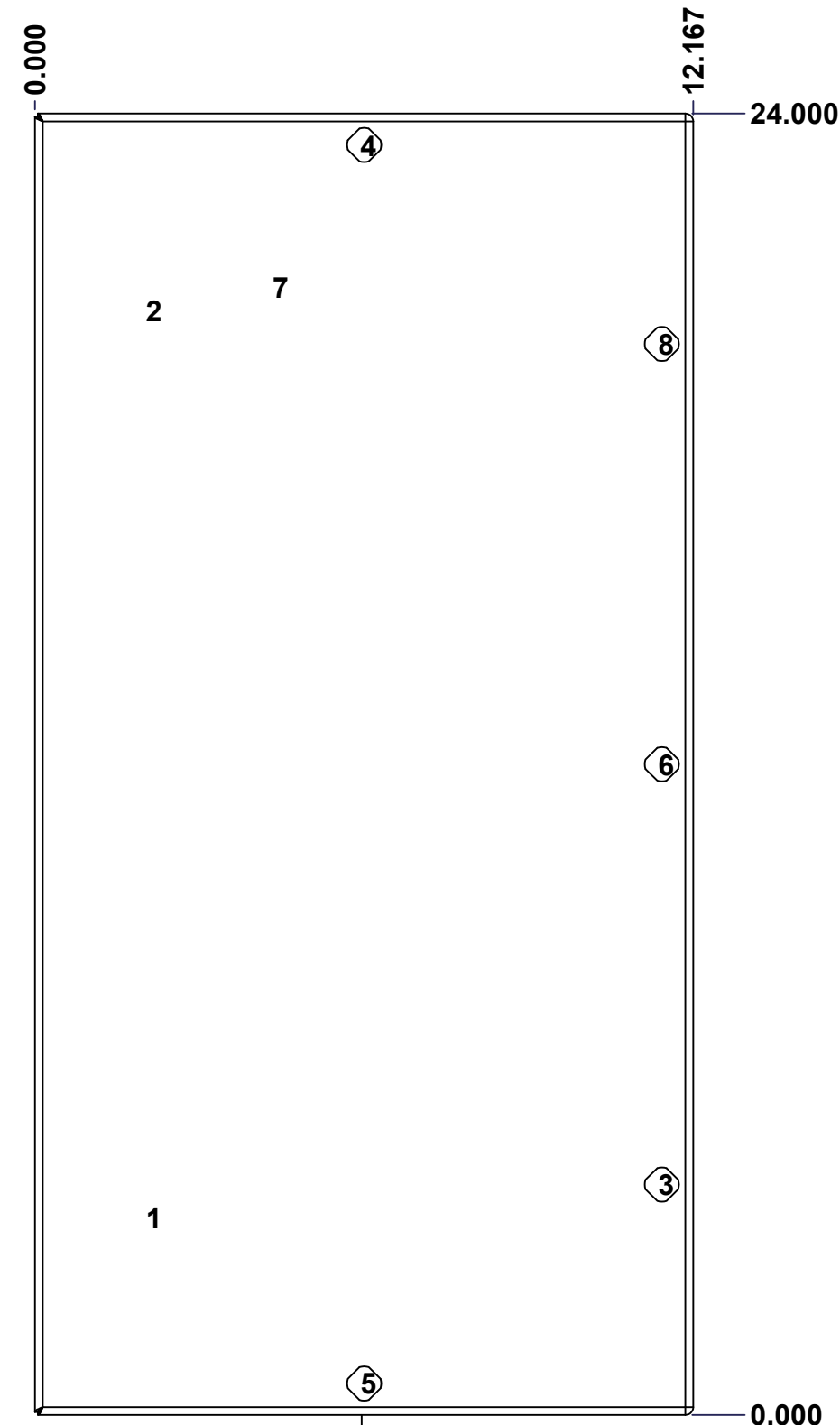

FRONT

	Description	Status	
	5412ESEL 24" x 12" Cover	(NULL)	
	Part Number Numéro Pièce	Rev.	
	5412ESEL241206_mcC	0	2 3

This drawing is confidential and must not be reproduced or used without the consent of EXM

Ce dessin est confidentiel et ne doit pas être reproduit ou utilisé sans le consentement de EXM

No.	Revisions	Date	By/Par

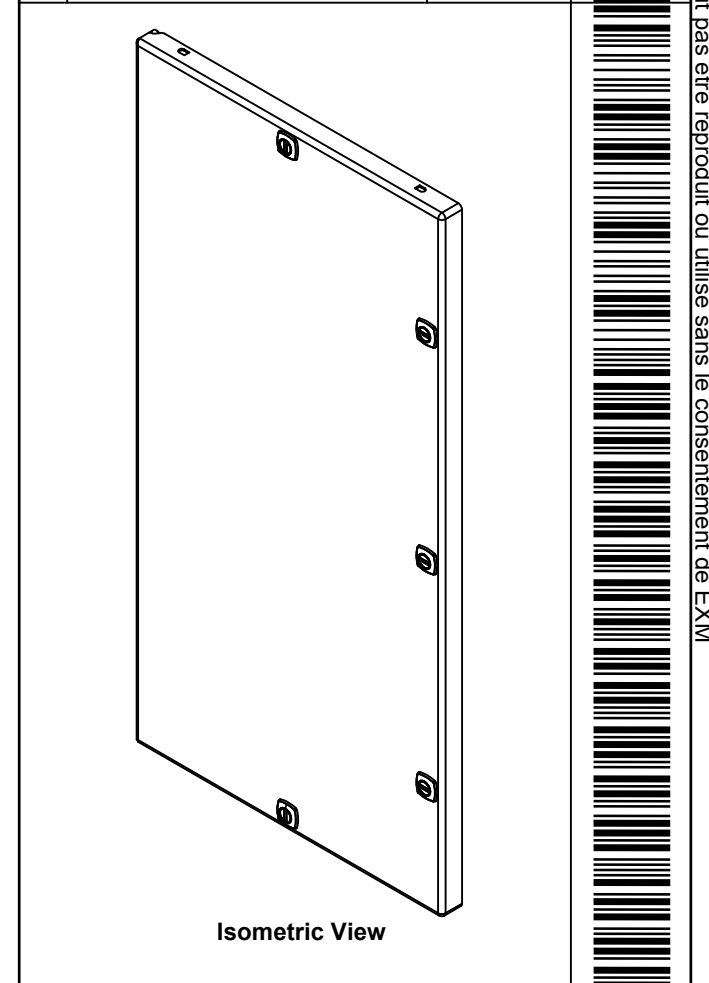

Qty	Part Name	Rev	Description
5	STK-A-79955	2	5412 ESEL Plastic Clip-in 1/4 Turn Lock
1	STK-P-02400S	0	Powder Paint (Asa-61 Grey / Smooth)
2	STK-Q-16055	1	M6 x 18mm Stud (No Paint Cap Required)
1	STK-S-00100	0	3.5" x 2" Silver Milar Flexcon Sticker
1	5412ESEL241206_mcHP-P	0	5412ESEL 24" x 12" Cover Part
1	5412ESEL241206_mcH-P	0	5412ESEL 24" x 12" Cover Part
1	STK-Q-46020-20	5	5412 ES Vertical Door Stiffener 20"
1	5412ESEL241206_mcG	0	5412ESEL 24" x 12" Cover Gasket Part
1	5412ESEL241206_mcC-P	0	5412ESEL 24" x 12" Cover Part
2	STK-Q-07220	1	M6 Nylon Insert Lock Nut

Parts List

Tél: (450) 979-4373 Fax: (450) 979-4626 www.exmweb.com		Flatness Aplatissement Max 3.0mm Projection
Customer Client	Date	
Drawn By Dessiné Par	BoxCad: BoxCad	Date 16-Jan-20
Material Matière	16 Ga H.R.P. & O. (1.4mm)	
Color Couleur	Asa-61 Grey	Finish Fini Smooth
Description		Detail Rev.
5412ESEL 24" x 12" Cover		
Part Number Numéro Pièce	Rev.	3
5412ESEL241206_mcC	0	3

This drawing is confidential and must not be reproduced or used without the consent of EXM

Ce dessin est confidentiel et ne doit pas être reproduit ou utilisé sans le consentement de EXM

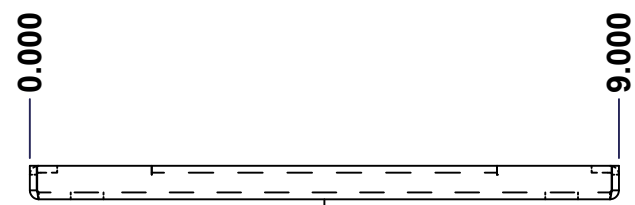

TOP

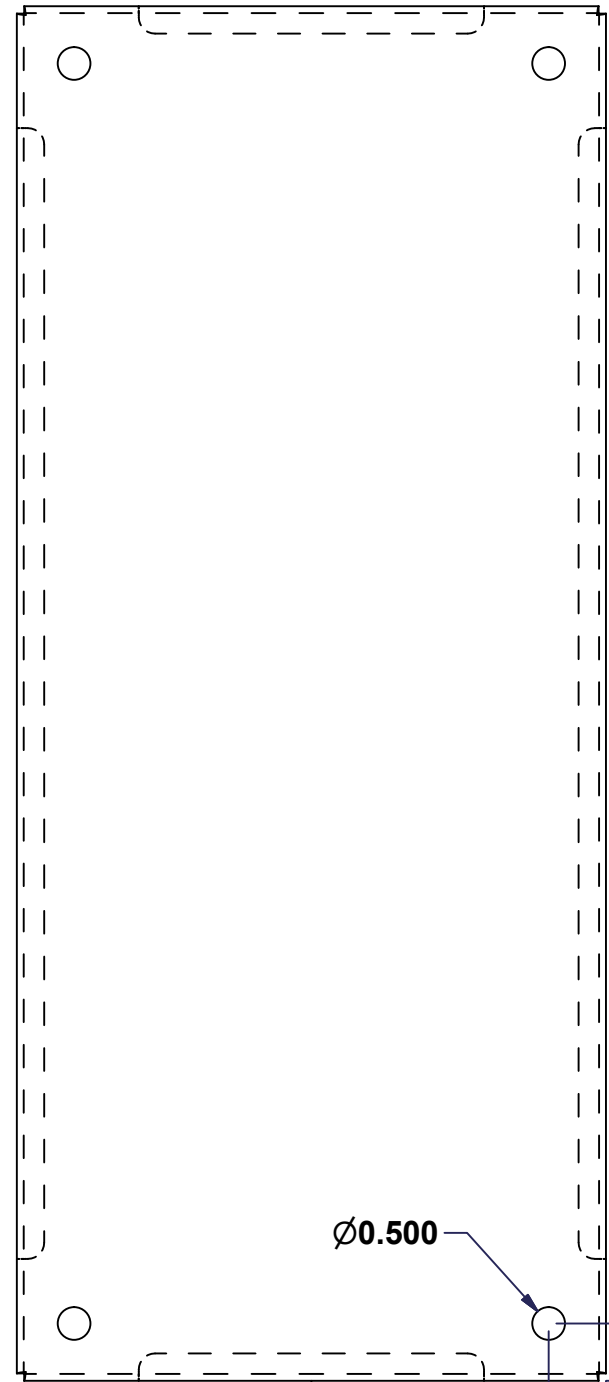

FRONT

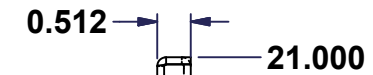

RIGHT

0.000

No.	Revisions	Date	By/Par

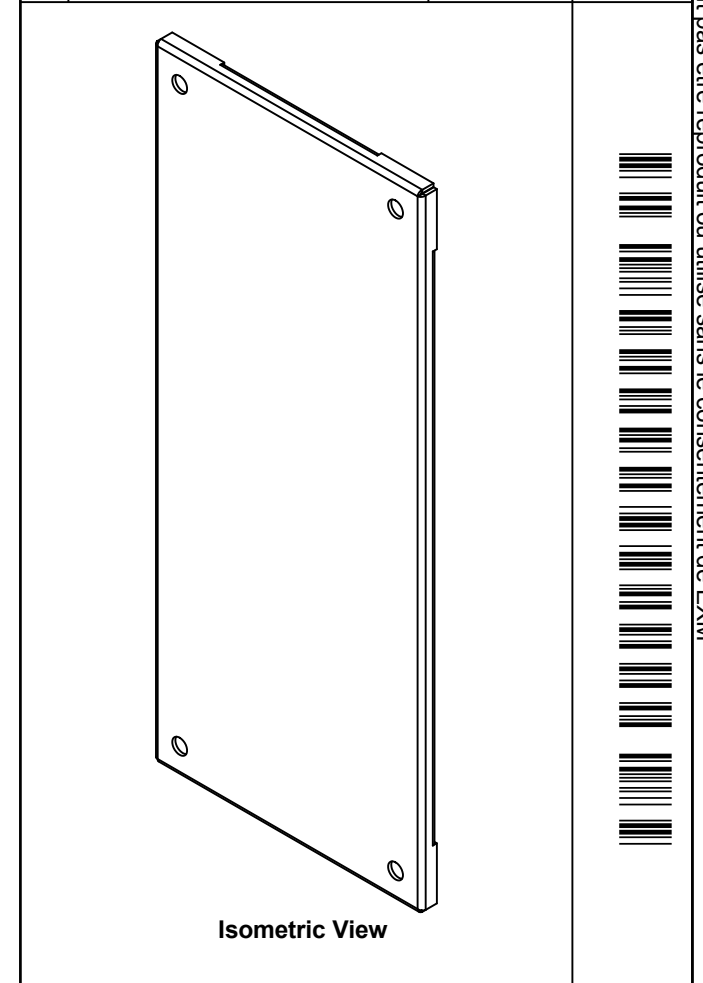

Isometric View



Tél: (450) 979-4373
 Fax: (450) 979-4626
www.exmweb.com

Flatness
Aplatissement

Max 3.0mm

Projection

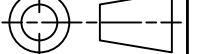

Customer Client	Date
Drawn By / Dessiné Par: BoxCad: nickz	Date: 01/03/2017
Material / Matière: 12 Ga Galvanized (2.5mm)	
Color / Couleur: See Part List	Finish / Fini: See Part List

Qty	Part Number	Rev	Description	Material	Color	Finish
1	885SP2412G-P	0	885SP 24" x 12" Inner Panel Part	12 Ga Galvanized (2.5mm)	Unpainted	Galvanized

Parts List

Description: 885SP 24" x 12" Inner Panel Part		Detail Rev.	
Part Number / Numéro Pièce: 885SP2412G	Rev.:	1	1