

This drawing is confidential and must not be reproduced or used without the consent of EXM

Ce dessin est confidentiel et ne doit pas être reproduit ou utilisé sans le consentement de EXM

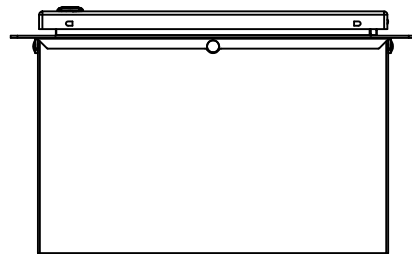

TOP

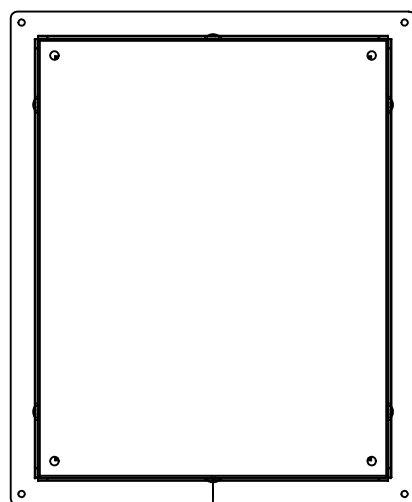

BACK

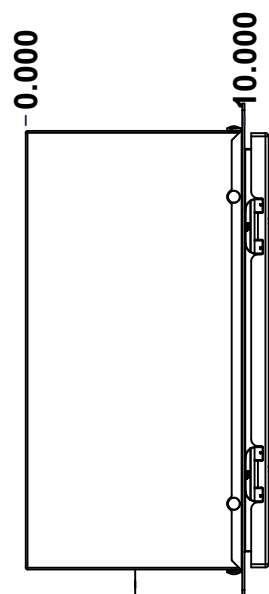

LEFT

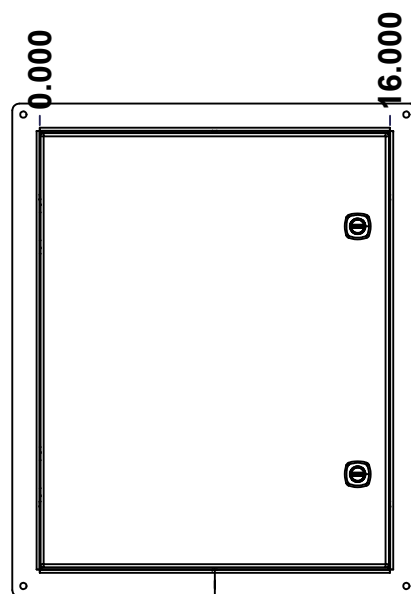

FRONT

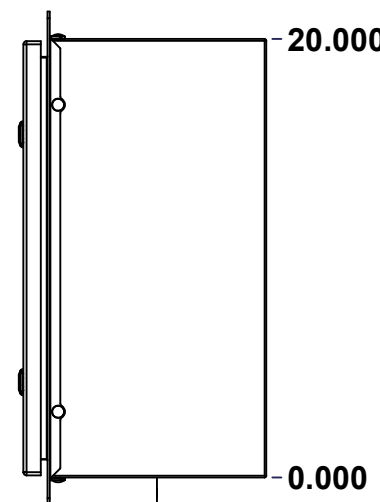

RIGHT

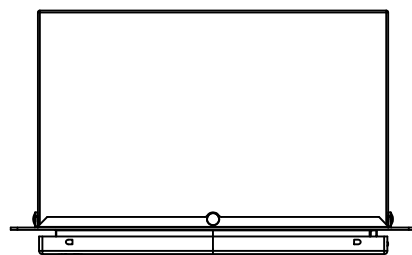

BOTTOM

No.	Revisions	Date	By/Par

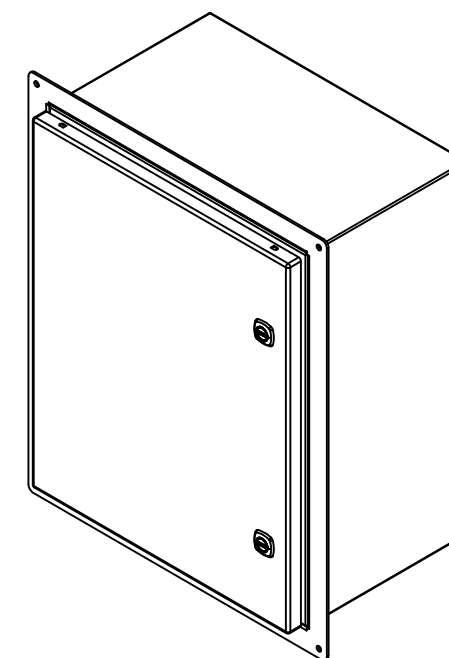

Isometric View



Tél: (450) 979-4373
 Fax: (450) 979-4626
www.exmweb.com

Flatness
Aplatissement

Max 3.0mm

Projection

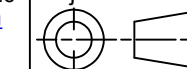

Customer Client	Date
Drawn By / Dessiné Par: BoxCad: BoxCad	Date: 17-Feb-14

Material / Matière: 16 Ga H.R.P. & O. (1.4mm)

Color / Couleur: Asa-61 Grey	Finish / Fini: Smooth
------------------------------	-----------------------

Description: 5412ESFM 20" x 16" x 10" Assembly	Detail Rev.
--	-------------

Part Number / Numéro Pièce: 5412ESFM201610	Rev. 0	1	2
--	--------	---	---

SEE BILL OF MATERIAL ON LAST PAGE

This drawing is confidential and must not be reproduced or used without the consent of EXM

Ce dessin est confidentiel et ne doit pas être reproduit ou utilisé sans le consentement de EXM

NOTE	
ITEM	DESCRIPTION
1	NEMA 4/12 Enclosure
2	C/W Standard ground studs on box and cover
3	C/W Standard door stiffener
4	C/W Standard inner panel (Included)
5	C/W Standard inner panel mounting studs

No.	Revisions	Date	By/Par

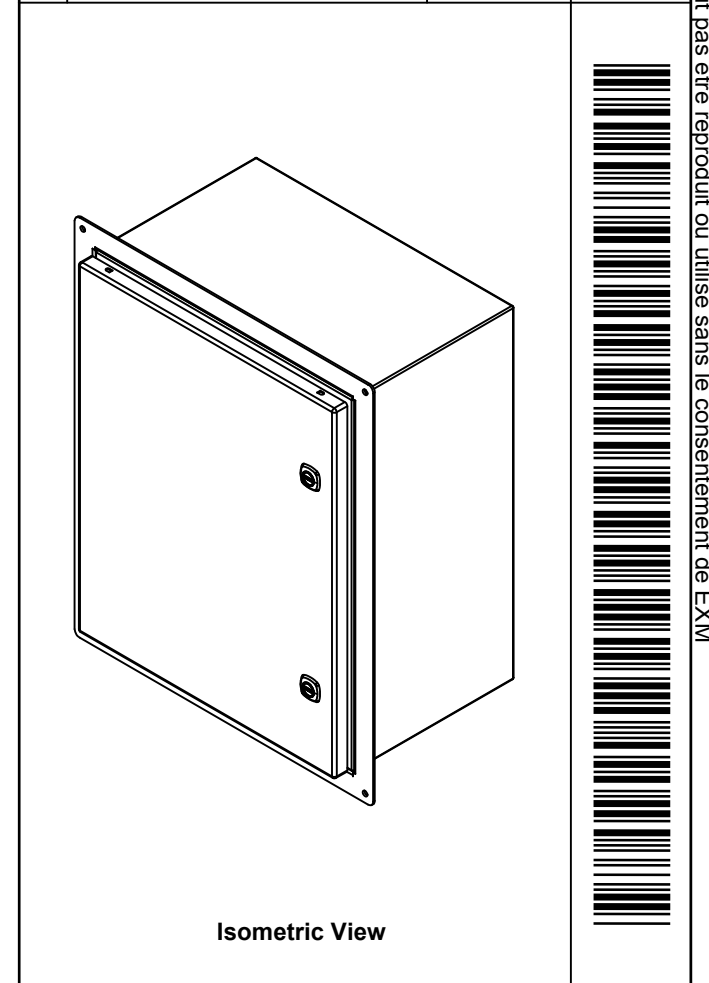

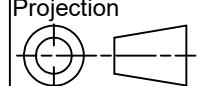
 Tél: (450) 979-4373 Fax: (450) 979-4626 www.exmweb.com		Flatness Aplatissement Max 3.0mm Projection 
Customer Client	Date	
Drawn By Dessiné Par	BoxCad: BoxCad	Date 17-Feb-14
Material Matière	16 Ga H.R.P. & O. (1.4mm)	
Color Couleur	Asa-61 Grey	Finish Fini Smooth
Description	Detail Rev.	
5412ESFM 20" x 16" x 10" Assembly		
Part Number Numéro Pièce	5412ESFM201610	Rev. 0

Qty	Part Number	Rev	Description
1	STK-K-01800	5	5412 ES Accessory Kit
1	880 PP	6	Self Adhesive Print Pocket
1	881 SP2016G	0	881 SP - Inner Panel
1	5412ESFM201610C	0	5412ESFM 20" x 16" Cover
4	STK-Q-07310	2	Flange Lock Nut M8
4	STK-Q-07610	8	M8 Plastic Spacer 22.2mm
1	5412ESFM201610B	0	5412ESFM 20" x 16" x 10" Body
2	STK-Q-04050-07	7	M6 x 7mm Hexagon Socket Head Machine Screw with Nyseal
Parts List			

PACKING		
ITEM	QTY	DESCRIPTION
Cardboard sleeve	2	Top and Bottom
Cardboard strip	2	Between back of enclosure and inner panel
Plastic bag	1	To protect cover surface and inside gasket
Plastic strap - Black	2	To Squeeze the 2 cardboard sleeve together
Packaging label	1	White label with product number

This drawing is confidential and must not be reproduced or used without the consent of EXM

Ce dessin est confidentiel et ne doit pas être reproduit ou utilisé sans le consentement de EXM

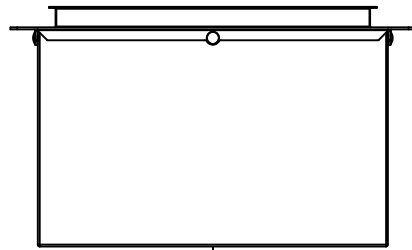

TOP

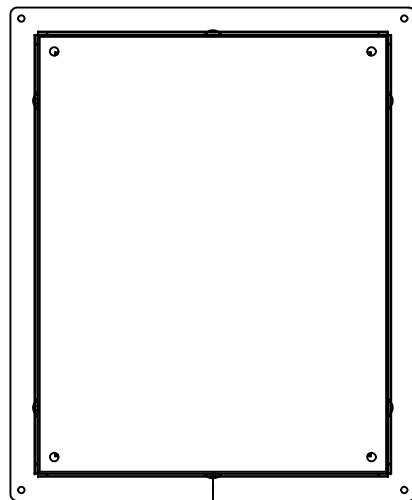

BACK

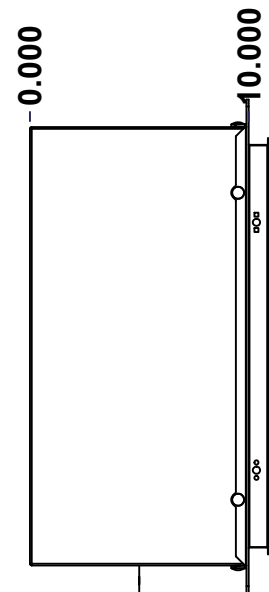

LEFT

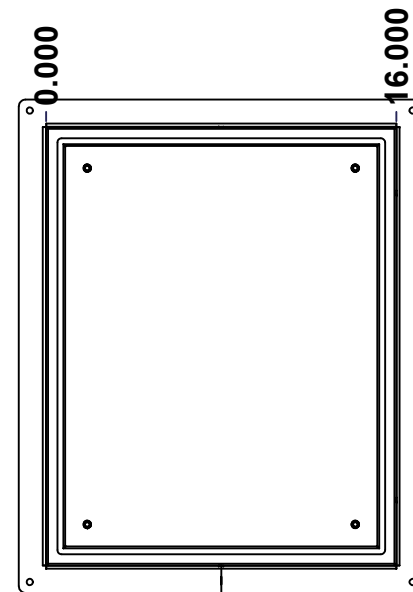

FRONT

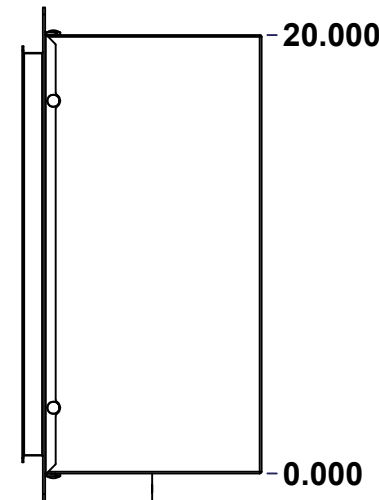

RIGHT

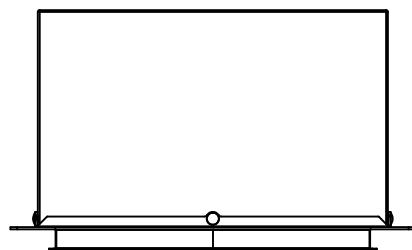

BOTTOM

No.	Revisions	Date	By/Par

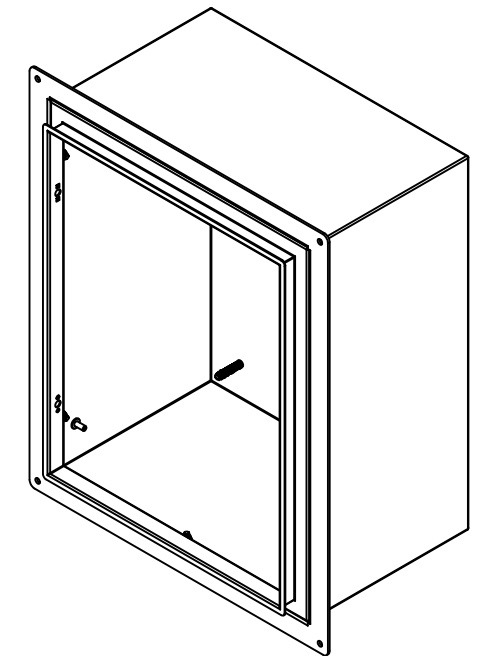

Isometric View



Tél: (450) 979-4373
 Fax: (450) 979-4626
www.exmweb.com

Flatness
Aplatissement

Max 3.0mm

Projection

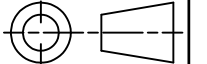

Customer Client	Date
Drawn By / Dessiné Par: BoxCad: BoxCad	Date: 17-Feb-14
Material / Matière: 16 Ga H.R.P. & O. (1.4mm)	
Color / Couleur: Asa-61 Grey	Finish / Fini: Smooth
Description: 5412ESFM 20" x 16" x 10" Body	
Part Number / Numéro Pièce: 5412ESFM201610B	Detail Rev.:
Rev. 0	1 / 7

SEE BILL OF MATERIAL ON LAST PAGE

This drawing is confidential and must not be reproduced or used without the consent of EXM

Ce dessin est confidentiel et ne doit pas être reproduit ou utilisé sans le consentement de EXM

STANDARD FEATURES ARE NOT LISTED IN THIS HOLE TABLE			
HOLE TABLE - TOP VIEW (CUSTOM FEATURE ONLY)			
CUT-OUT	XDIM	YDIM	DESCRIPTION
1	8.000	9.514	RND Ø0.290

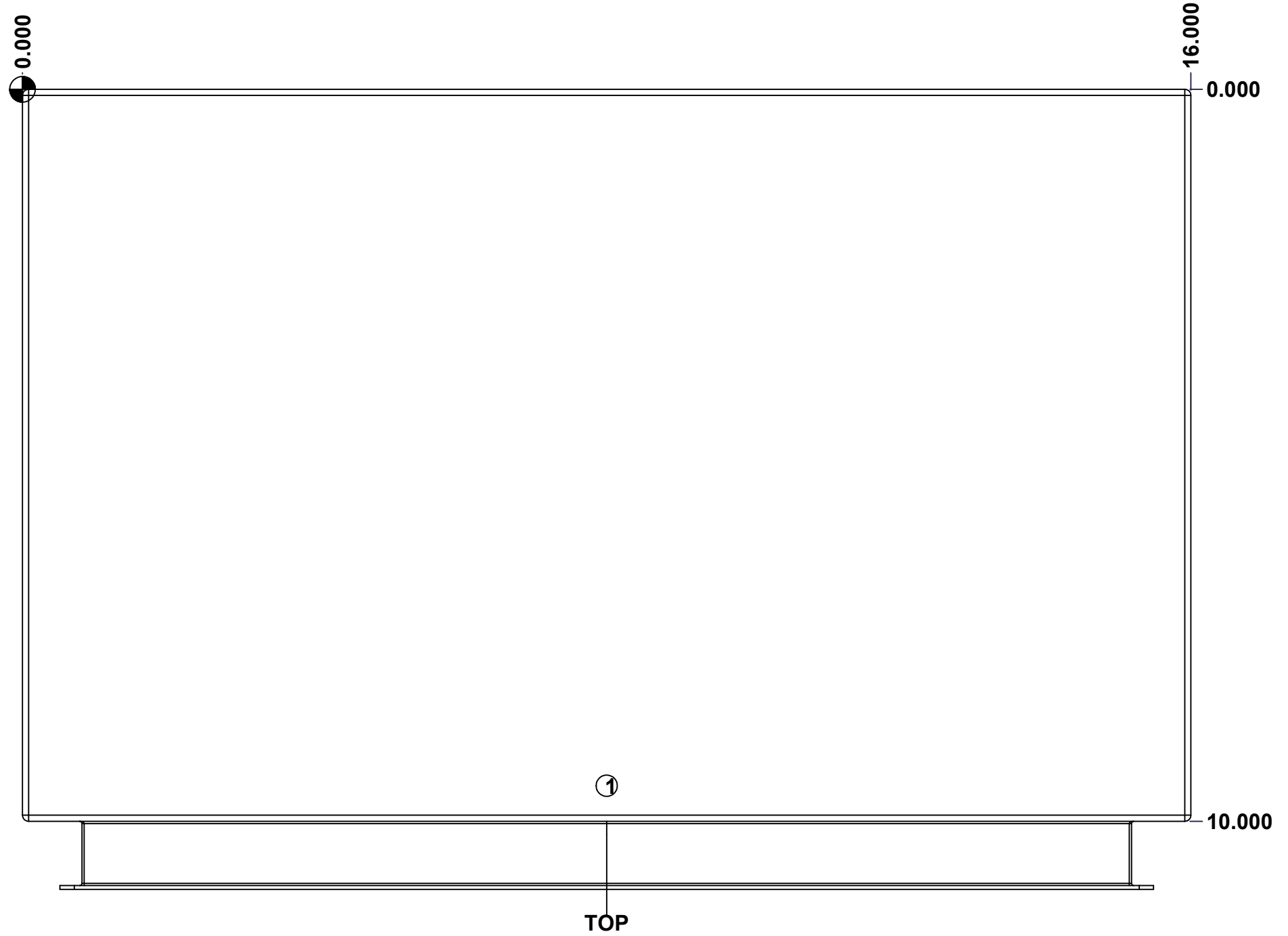

	Description		Status	
	5412ESFM 20" x 16" x 10" Body			
	Part Number Numéro Pièce		Rev.	2
	5412ESFM201610B		0	7

This drawing is confidential and must not be reproduced or used without the consent of EXM

Ce dessin est confidentiel et ne doit pas être reproduit ou utilisé sans le consentement de EXM

STANDARD FEATURES ARE NOT LISTED IN THIS HOLE TABLE			
HOLE TABLE - RIGHT VIEW (CUSTOM FEATURE ONLY)			
CUT-OUT	XDIM	YDIM	DESCRIPTION
1	9.514	17.000	RND Ø0.290
2	9.514	3.000	RND Ø0.290

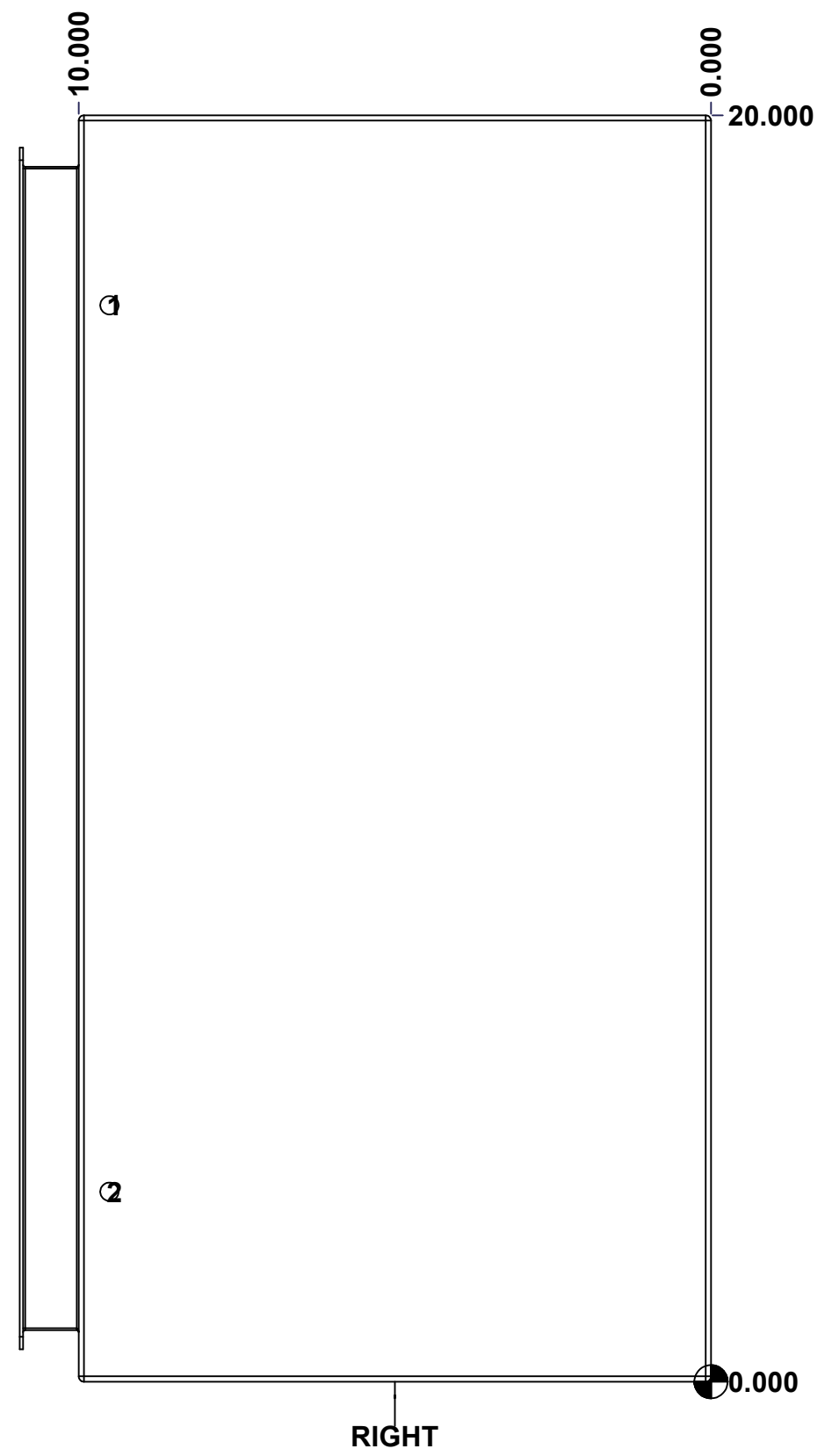

	Description		Status	
	5412ESFM 20" x 16" x 10" Body			
	Part Number Numéro Pièce		Rev.	
	5412ESFM201610B		0	3 / 7

This drawing is confidential and must not be reproduced or used without the consent of EXM

Ce dessin est confidentiel et ne doit pas être reproduit ou utilisé sans le consentement de EXM

STANDARD FEATURES ARE NOT LISTED IN THIS HOLE TABLE

HOLE TABLE - BOTTOM VIEW (CUSTOM FEATURE ONLY)

CUT-OUT	XDIM	YDIM	DESCRIPTION
1	8.000	9.514	RND Ø0.290

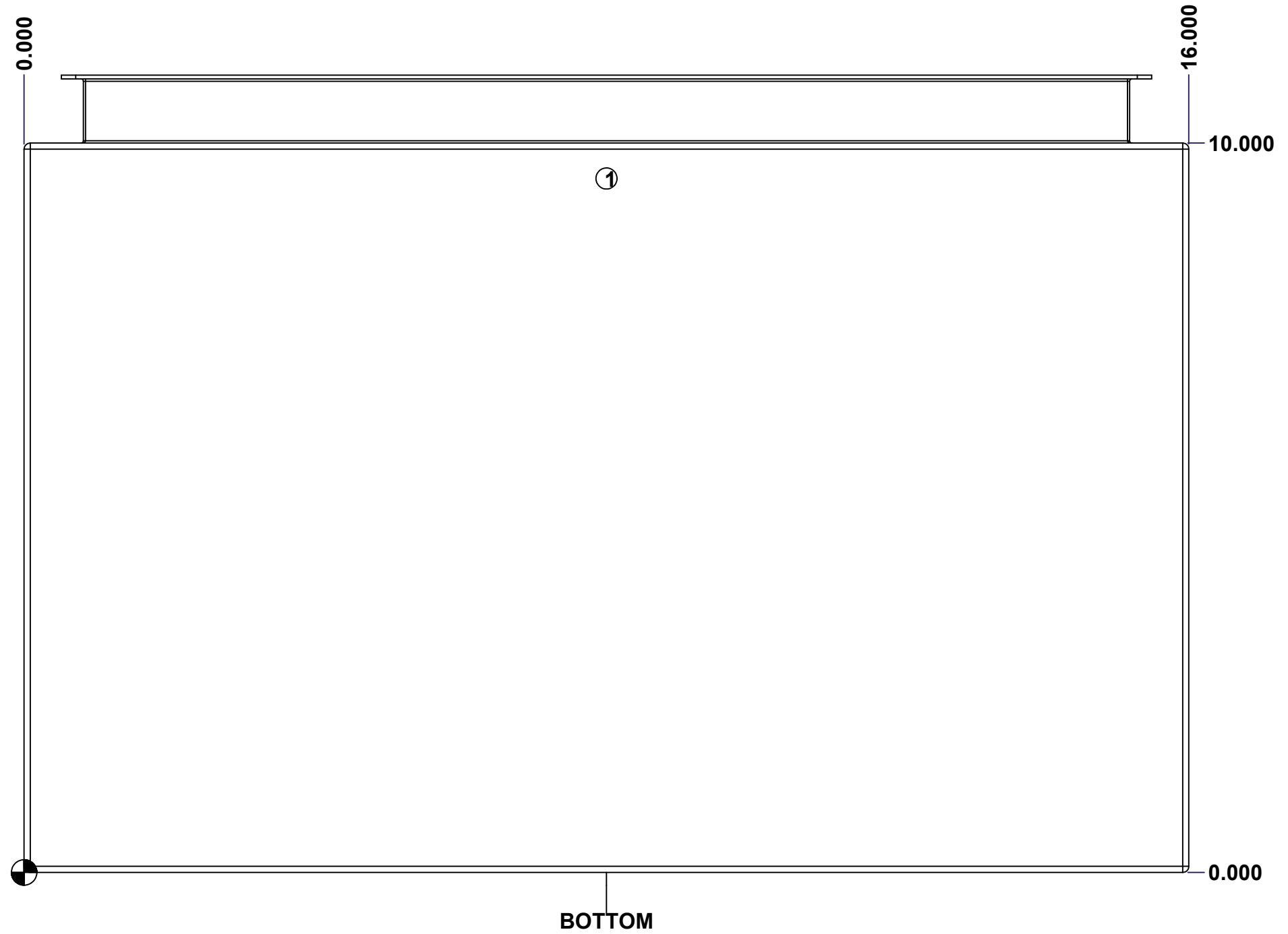

	Description		Status	
	5412ESFM 20" x 16" x 10" Body			
Part Number Numéro Pièce		Rev.	4	
5412ESFM201610B		0	7	

This drawing is confidential and must not be reproduced or used without the consent of EXM

Ce dessin est confidentiel et ne doit pas être reproduit ou utilisé sans le consentement de EXM

STANDARD FEATURES ARE NOT LISTED IN THIS HOLE TABLE			
HOLE TABLE - LEFT VIEW (CUSTOM FEATURE ONLY)			
CUT-OUT	XDIM	YDIM	DESCRIPTION
1	9.514	17.000	RND Ø0.290
2	9.514	3.000	RND Ø0.290
3	8.500	2.000	GND STUD M6 x 16mm (Inside)

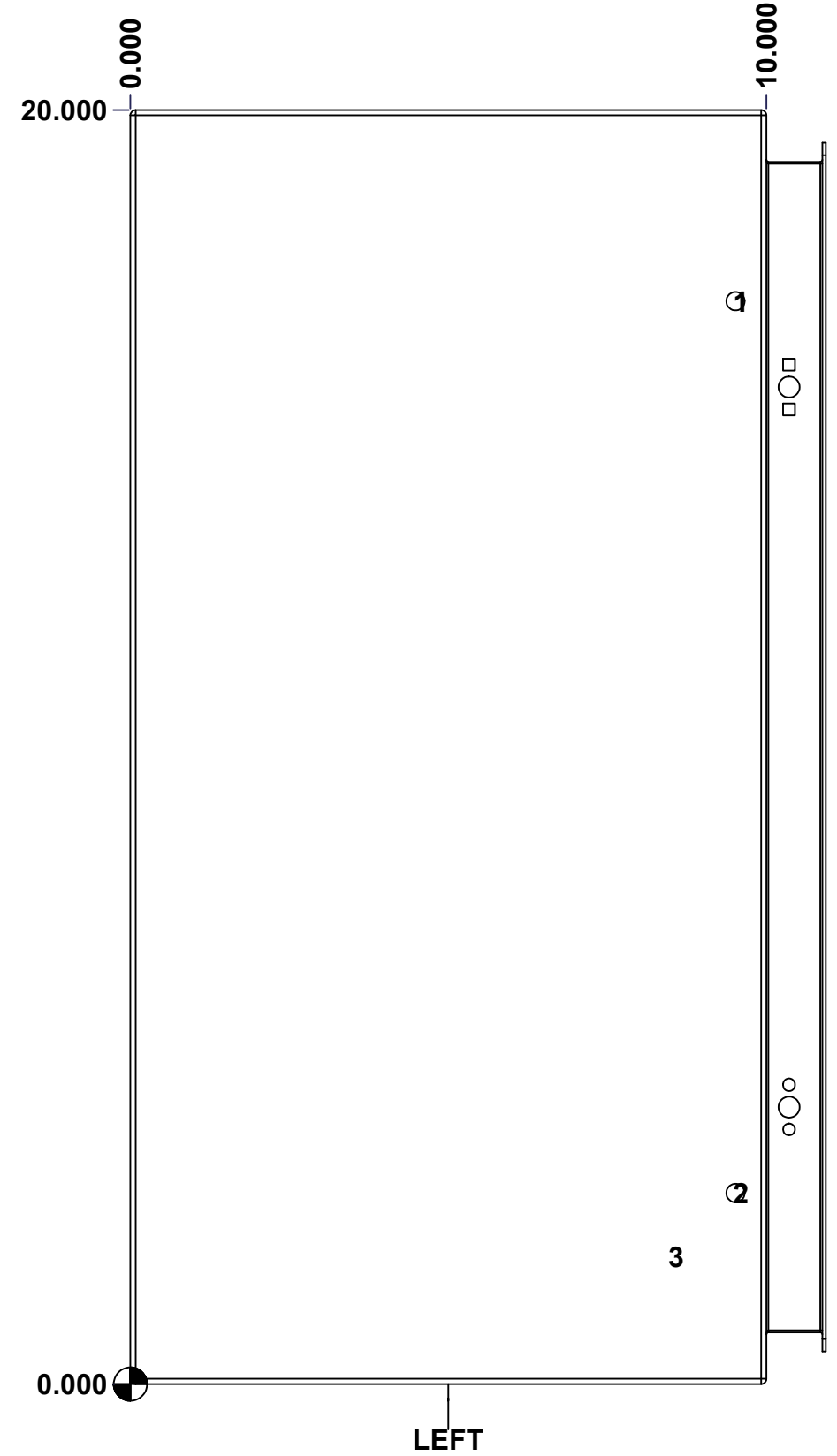

	Description	Status	
	5412ESFM 20" x 16" x 10" Body		
	Part Number Numéro Pièce	Rev.	5 / 7
	5412ESFM201610B	0	

This drawing is confidential and must not be reproduced or used without the consent of EXM

Ce dessin est confidentiel et ne doit pas être reproduit ou utilisé sans le consentement de EXM

STANDARD FEATURES ARE NOT LISTED IN THIS HOLE TABLE

HOLE TABLE - BACK VIEW (CUSTOM FEATURE ONLY)

CUT-OUT	XDIM	YDIM	DESCRIPTION
1	1.875	1.875	IP STUD M8 x 35mm (Inside)
2	1.875	18.125	IP STUD M8 x 35mm (Inside)
3	14.125	18.125	IP STUD M8 x 35mm (Inside)
4	14.125	1.875	IP STUD M8 x 35mm (Inside)

5	15.250	0.750	RND Ø0.390
6	15.250	19.250	RND Ø0.390
7	0.750	19.250	RND Ø0.390
8	0.750	0.750	RND Ø0.390

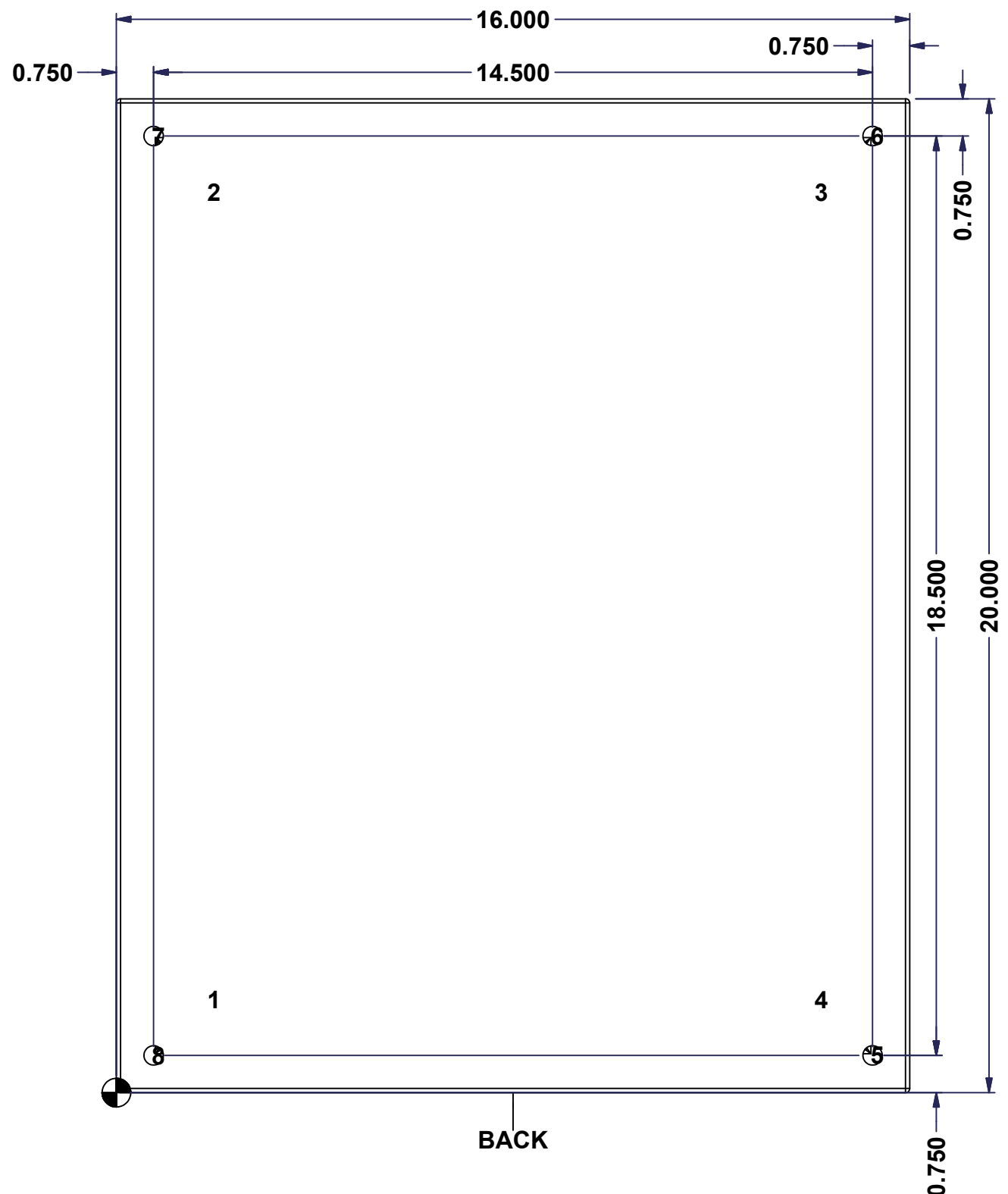

BACK

	Description	Status
	5412ESFM 20" x 16" x 10" Body	
	Part Number Numéro Pièce	Rev.
	5412ESFM201610B	0
		6
		7

This drawing is confidential and must not be reproduced or used without the consent of EXM

Ce dessin est confidentiel et ne doit pas être reproduit ou utilisé sans le consentement de EXM

STANDARD FEATURES ARE NOT LISTED IN THIS HOLE TABLE

HOLE TABLE - FRONT VIEW (CUSTOM FEATURE ONLY)

CUT-OUT	XDIM	YDIM	DESCRIPTION
1	18.000	0.500	RND Ø0.290
2	18.000	22.000	RND Ø0.290
3	0.500	22.000	RND Ø0.290
4	0.500	0.500	RND Ø0.290

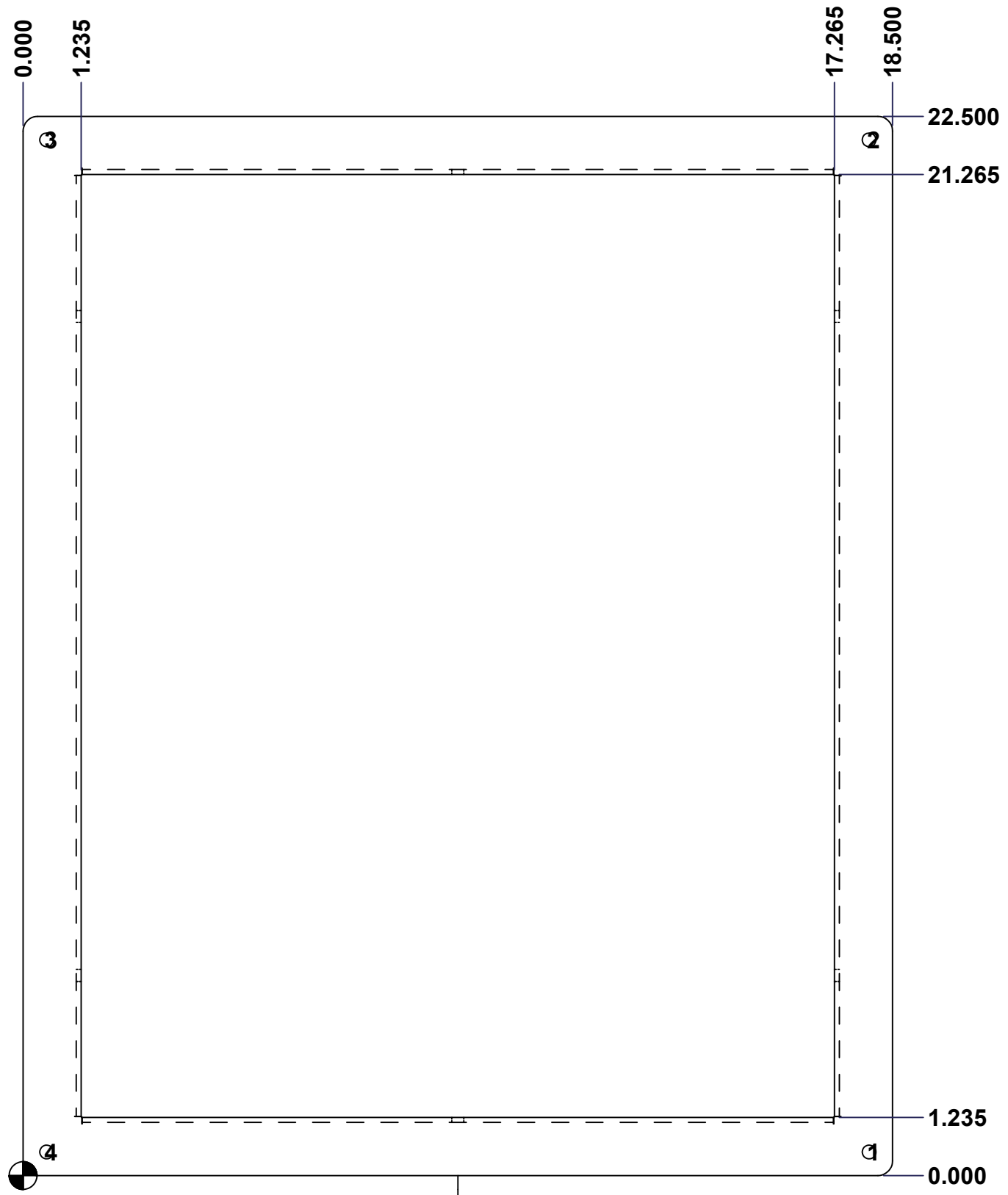

FRONT

	Description	Status	
	5412ESFM 20" x 16" x 10" Flange		
	Part Number Numéro Pièce	Rev.	1/1
	5412ESFM201610B	0	

This drawing is confidential and must not be reproduced or used without the consent of EXM

Ce dessin est confidentiel et ne doit pas être reproduit ou utilisé sans le consentement de EXM

No.	Revisions	Date	By/Par

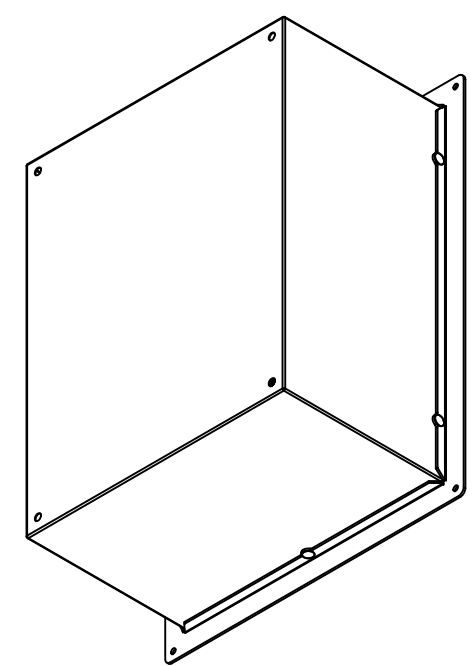

Isometric View

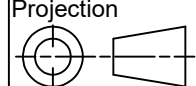

 Tél: (450) 979-4373 Fax: (450) 979-4626 www.exmweb.com		Flatness Aplatissement Max 3.0mm Projection 
Customer Client	Date	
Drawn By Dessiné Par	BoxCad: BoxCad	Date 17-Feb-14
Material Matière	16 Ga H.R.P. & O. (1.4mm)	
Color Couleur	Asa-61 Grey	Finish Fini Smooth
Description	Detail Rev.	
5412ESFM 20" x 16" x 10" Body		
Part Number Numéro Pièce	Rev.	7
5412ESFM201610B	0	7

Qty	Part Number	Rev	Description
1	STK-Q-16080	0	Ground Stud M6 x 16mm
1	5412ESFM201610F	0	5412ESFM 20" x 16" x 10" Flange
1	STK-P-02400S	0	Powder Paint (Asa-61 Grey / Smooth)
4	STK-Q-16005	1	Stud M8 x 35 (No Paint Cap Required)
1	5412ESFM201610B-P	0	5412ESFM 20" x 16" x 10" Body Part
Parts List			

This drawing is confidential and must not be reproduced or used without the consent of EXM

Ce dessin est confidentiel et ne doit pas être reproduit ou utilisé sans le consentement de EXM

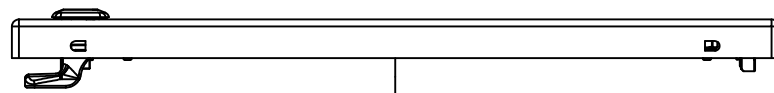

TOP

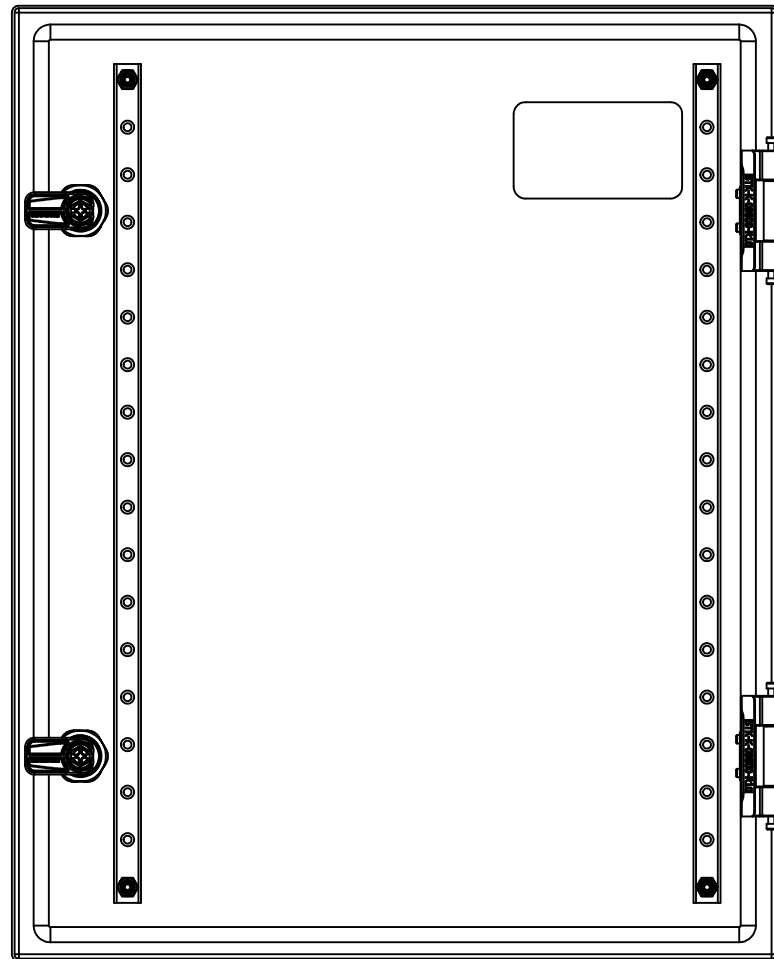

BACK

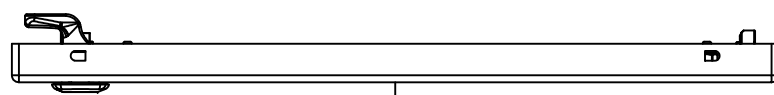

BOTTOM

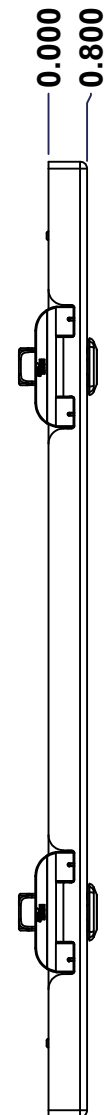

LEFT

0.000
0.800

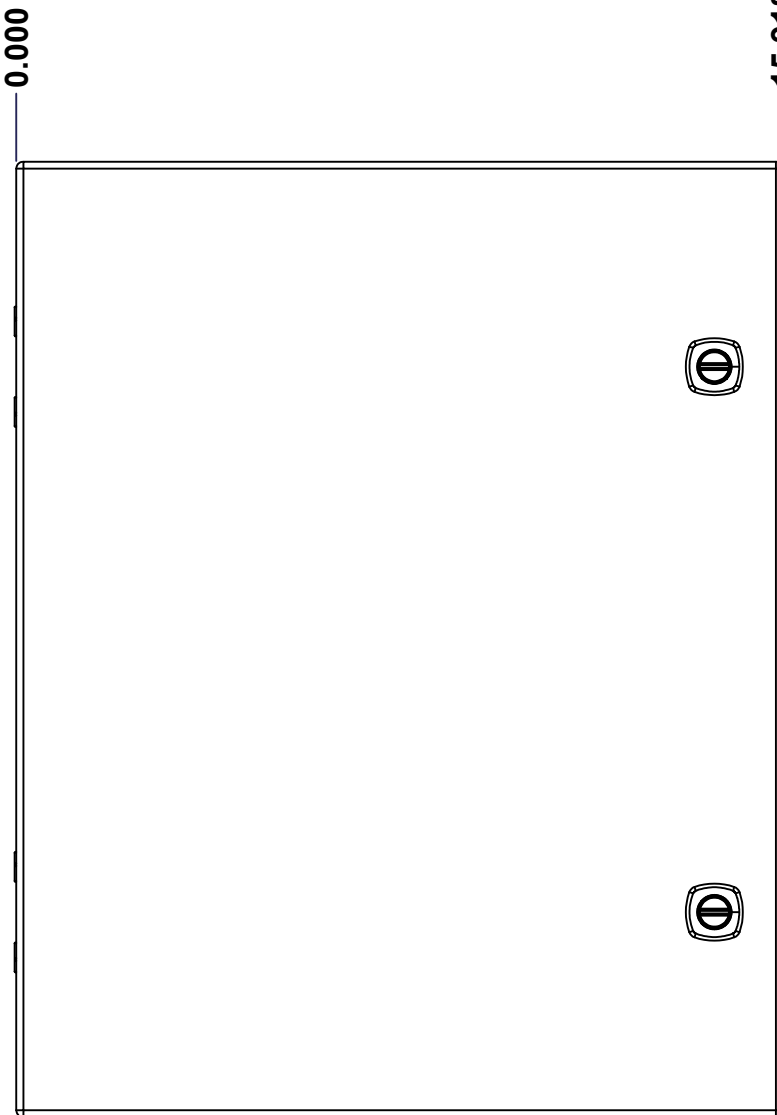

FRONT

0.000
15.918

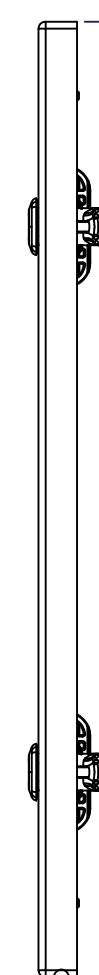

RIGHT

19.803

0.000

No.	Revisions	Date	By/Par

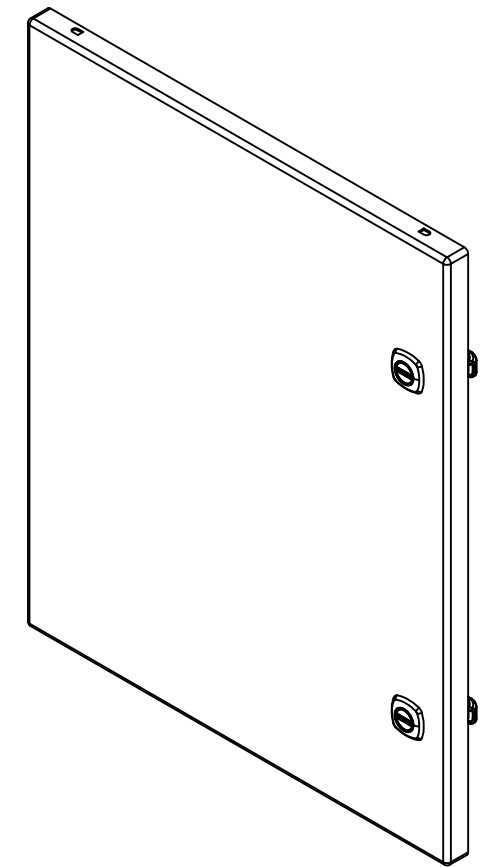

Isometric View



Tél: (450) 979-4373
Fax: (450) 979-4626
www.exmweb.com

Flatness
Aplatissement

Max 3.0mm

Projection

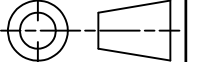

Customer Client	Date
Drawn By Dessiné Par BoxCad: BoxCad	Date 17-Feb-14
Material Matière 16 Ga H.R.P. & O. (1.4mm)	
Color Couleur Asa-61 Grey	Finish Fini Smooth
Description 5412ESFM 20" x 16" Cover	Detail Rev.
Part Number Numéro Pièce 5412ESFM201610C	Rev. 1 0 3

SEE BILL OF MATERIAL ON LAST PAGE

This drawing is confidential and must not be reproduced or used without the consent of EXM

Ce dessin est confidentiel et ne doit pas être reproduit ou utilisé sans le consentement de EXM

STANDARD FEATURES ARE NOT LISTED IN THIS HOLE TABLE

HOLE TABLE - FRONT VIEW (CUSTOM FEATURE ONLY)

CUT-OUT	XDIM	YDIM	DESCRIPTION
1	1.486	1.535	STUD M6 x 18mm (Inside)
2	1.486	18.268	STUD M6 x 18mm (Inside)
3	13.517	18.268	STUD M6 x 18mm (Inside)
4	13.517	1.535	STUD M6 x 18mm (Inside)

5	3.750	16.803	LABEL_EXM (Inside)
6	14.494	15.553	LOCK 880 SCQ4-SL @ 0.0°
7	14.494	4.250	LOCK 880 SCQ4-SL @ 0.0°

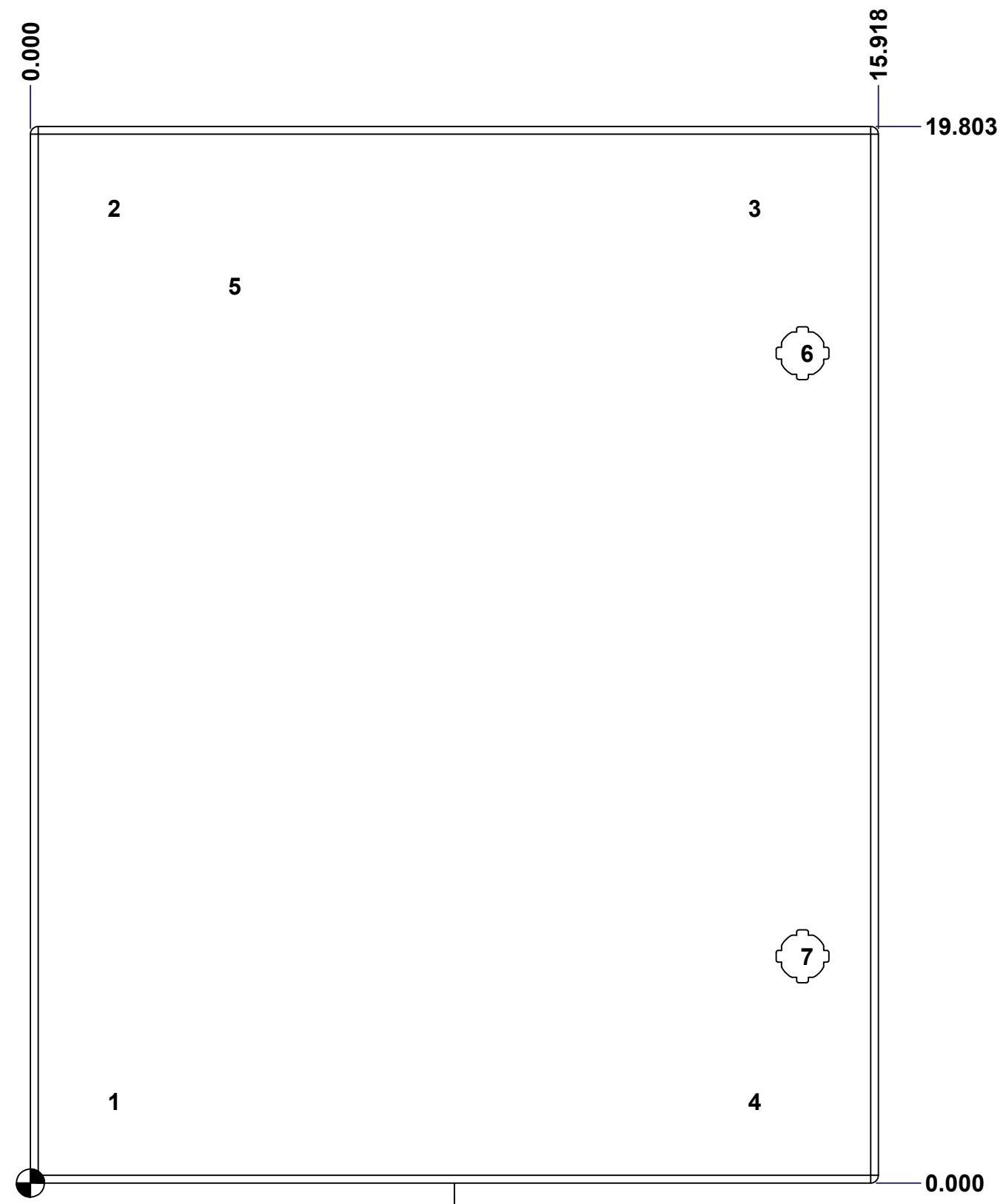

FRONT

	Description	Status
	5412ESFM 20" x 16" Cover	(NULL)
	Part Number Numéro Pièce	Rev.
	5412ESFM201610C	0
		2
		3

This drawing is confidential and must not be reproduced or used without the consent of EXM

Ce dessin est confidentiel et ne doit pas être reproduit ou utilisé sans le consentement de EXM

No.	Revisions	Date	By/Par

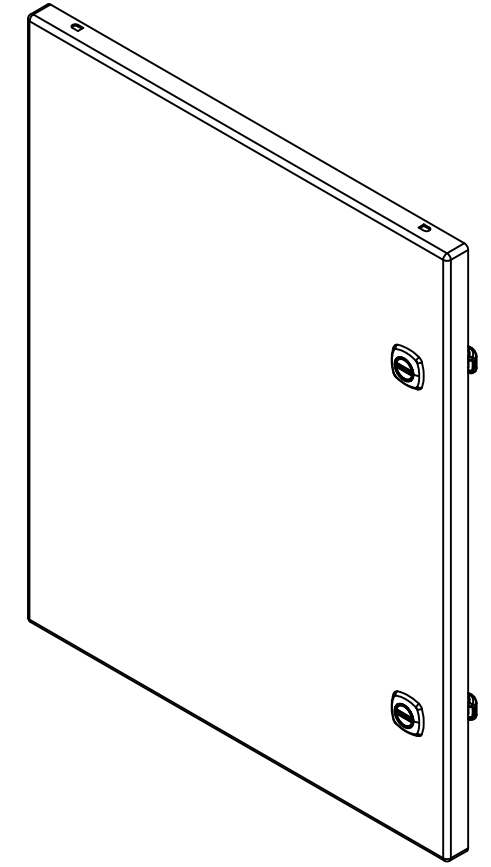

Isometric View

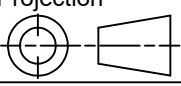

 Tél: (450) 979-4373 Fax: (450) 979-4626 www.exmweb.com		Flatness Aplatissement Max 3.0mm Projection 
Customer Client	Date	Date 17-Feb-14
Drawn By Dessiné Par	BoxCad: BoxCad	
Material Matière	16 Ga H.R.P. & O. (1.4mm)	
Color Couleur	Asa-61 Grey	Finish Fini Smooth
Description	5412ESFM 20" x 16" Cover	
Part Number Numéro Pièce	Rev. 0	3
5412ESFM201610C		

Qty	Part Name	Rev	Description
1	STK-S-00100	0	3.5" x 2" Silver Milar Flexcon Sticker
1	STK-P-02400S	0	Powder Paint (Asa-61 Grey / Smooth)
2	STK-Q-46020-20	5	5412 ES Vertical Door Stiffener 20"
4	STK-Q-16055	1	M6 x 18mm Stud (No Paint Cap Required)
1	5412ESFM201610G	0	5412ESFM 20" x 16" Cover Gasket Part
1	5412ESFM201610C-P	0	5412ESFM 20" x 16" Cover Part
2	STK-K-09800	10	5412 ES Hinge with 2 Captive Hinge Pins
2	880 SCQ4-SL	6	5412 ES 1/4 Turn Lock
4	STK-Q-07220	1	M6 Nylon Insert Lock Nut
Parts List			

This drawing is confidential and must not be reproduced or used without the consent of EXM

Ce dessin est confidentiel et ne doit pas être reproduit ou utilisé sans le consentement de EXM

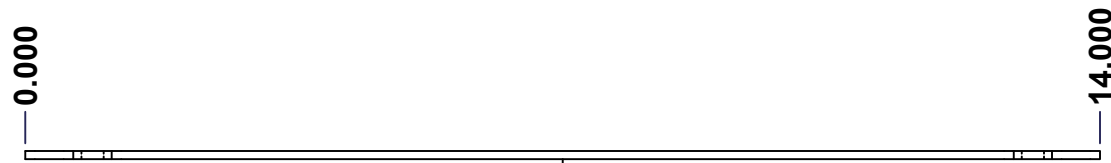

TOP

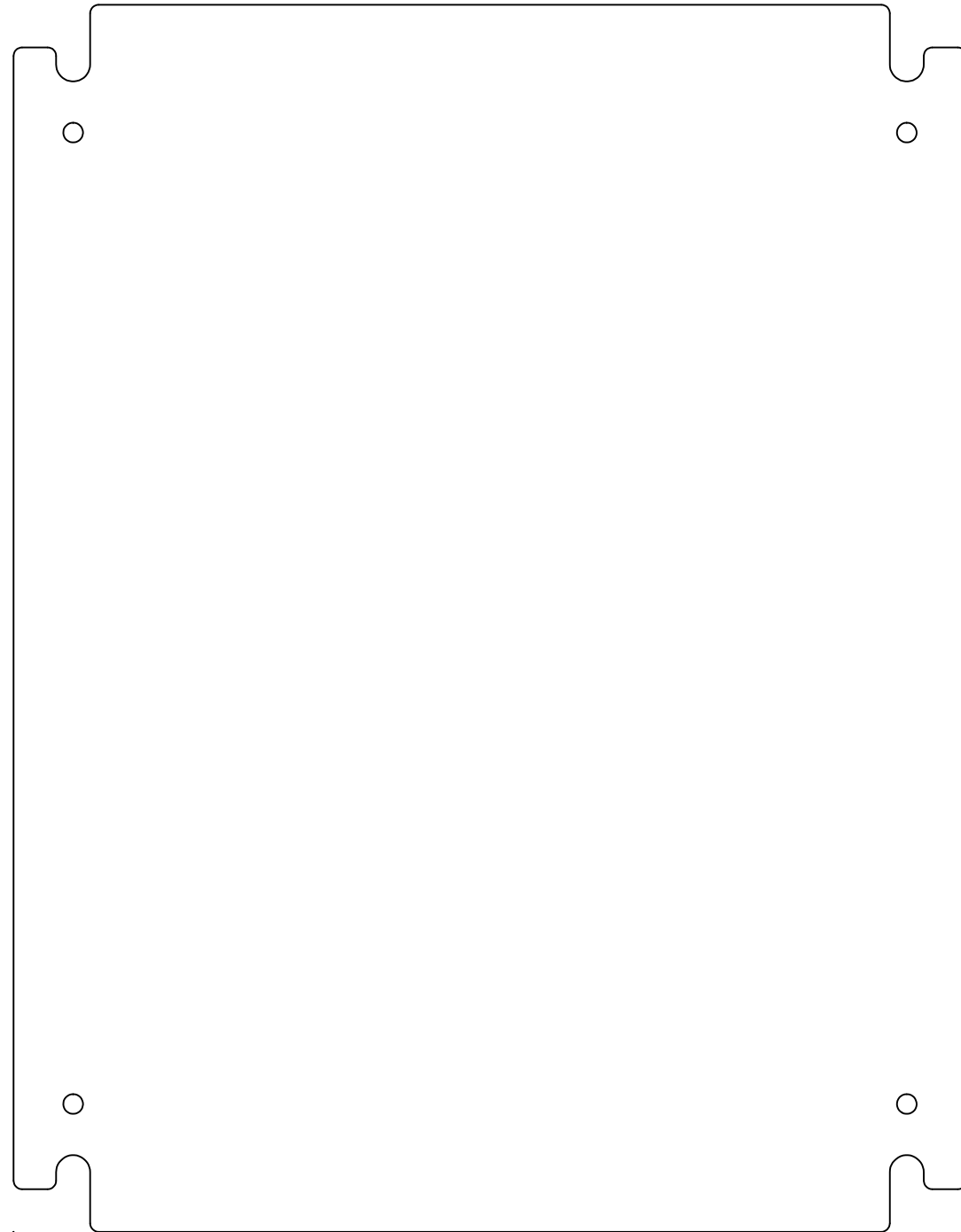

FRONT

18.000

0.000

RIGHT

No.	Revisions	Date	By/Par

Isometric View

		Flatness Aplatissement Max 3.0mm Projection	
Customer Client		Date	
Drawn By Dessiné Par BoxCad		Date 1/23/2007	
Material Matière See Part List			
Color Couleur See Part List		Finish Fini See Part List	
Description 881 SP - Inner Panel			Detail Rev.
Part Number Numéro Pièce 881 SP2016G			Rev. 1 0 2

Qty	Part Number	Rev	Description	Material	Color	Finish
1	881 SP2016G-P	0	881 SP - Inner Panel Part	12 Ga Galvanized	Unpainted	Galvanized
Parts List						

This drawing is confidential and must not be reproduced or used without the consent of EXM

Ce dessin est confidentiel et ne doit pas être reproduit ou utilisé sans le consentement de EXM

Table 1			FRONT VIEW
CUT-OUT	XDIM	YDIM	DESCRIPTION
1	0.875	1.875	GROUND HOLE (RND Ø0.290)
2	13.125	1.875	GROUND HOLE (RND Ø0.290)
3	0.875	16.125	GROUND HOLE (RND Ø0.290)
4	13.125	16.125	GROUND HOLE (RND Ø0.290)

All knockouts are actual size / Les disques défonçables sont grandeur réel

No.	Revisions	Date	By/Par

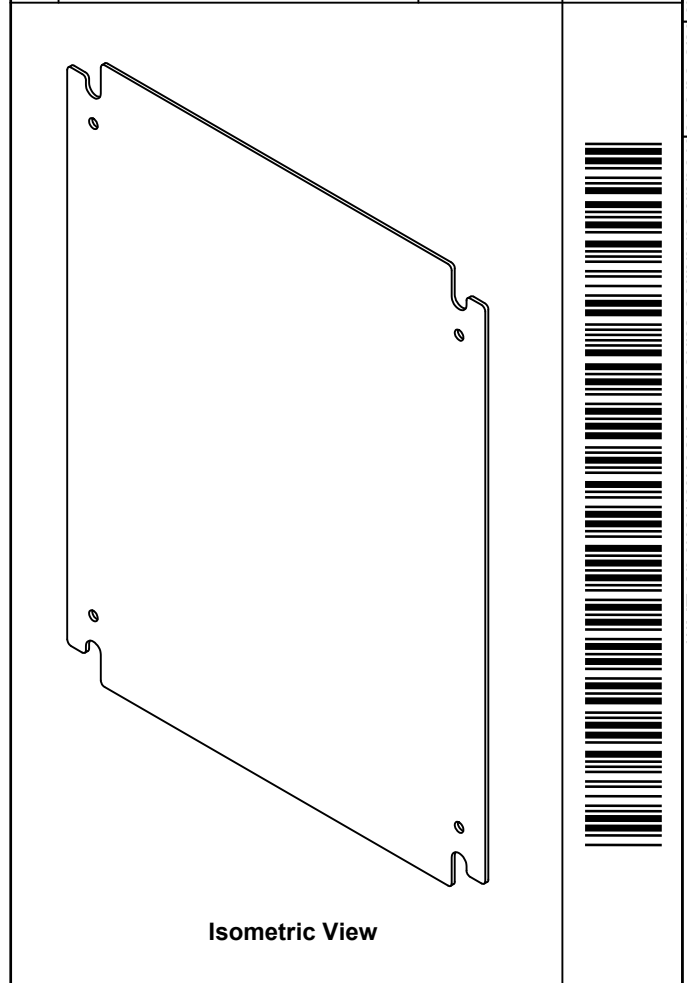
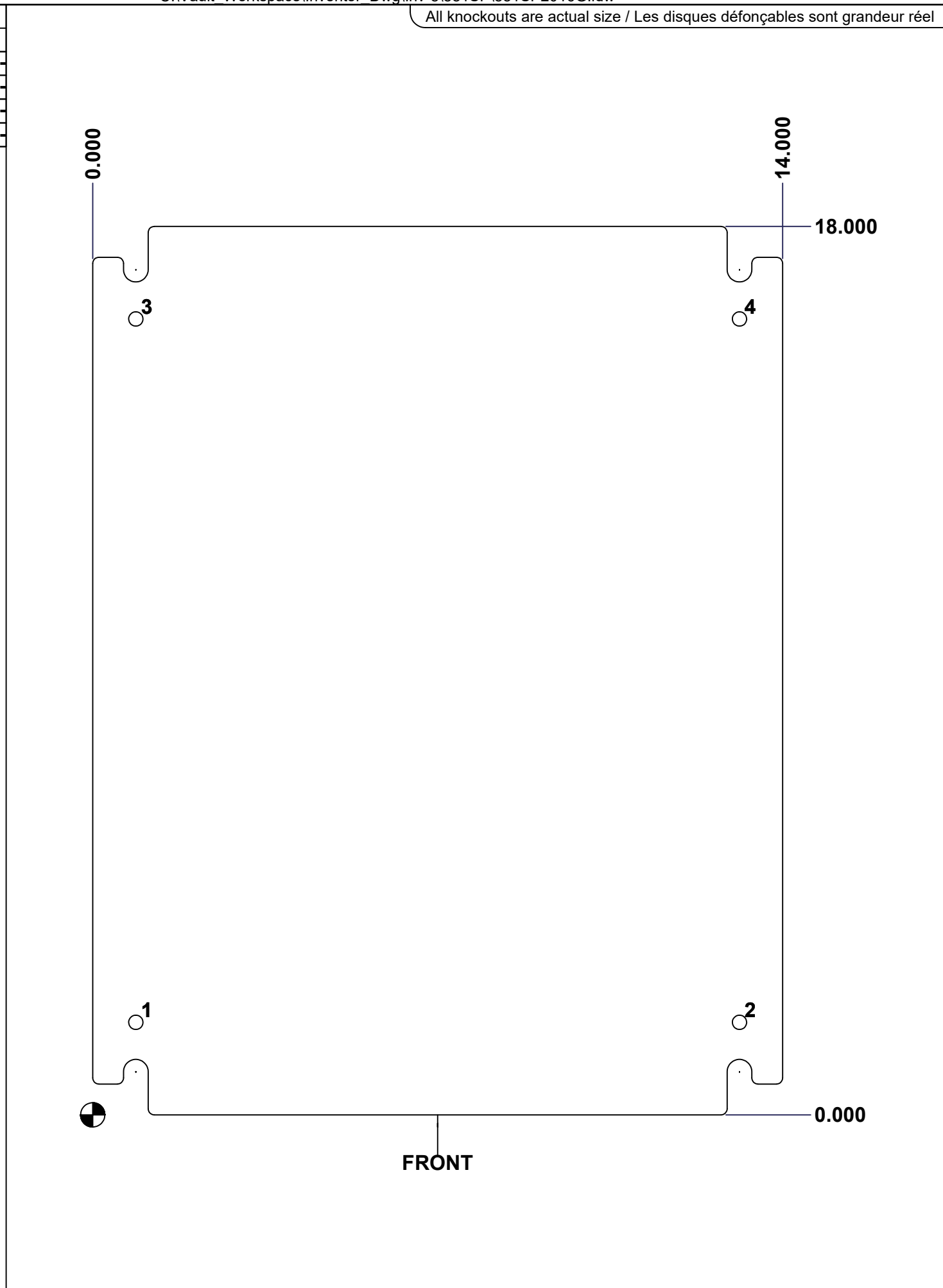

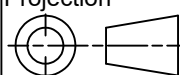
 Tél: (450) 979-4373 Fax: (450) 979-4626 www.exmweb.com	Flatness Aplatissement Max 3.0mm
	Projection 
Customer Client	Date
Drawn By Dessiné Par BoxCad	Date 1/23/2007
Material Matière	See Part List
Color Couleur	See Part List
Finish Fini	See Part List
Description 881 SP - Inner Panel	Detail Rev.
Part Number Numéro Pièce 881 SP2016G	Rev. 0

2
2