

This drawing is confidential and must not be reproduced or used without the consent of EXM

Ce dessin est confidentiel et ne doit pas être reproduit ou utilisé sans le consentement de EXM

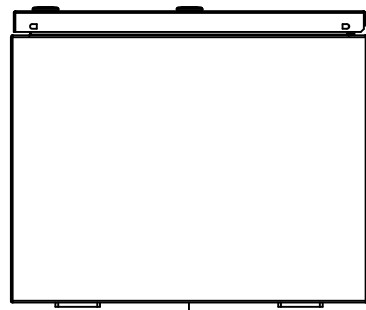

TOP

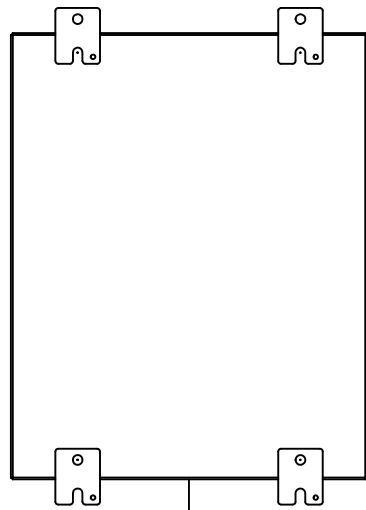

BACK

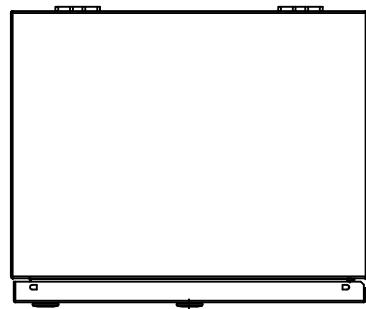

BOTTOM

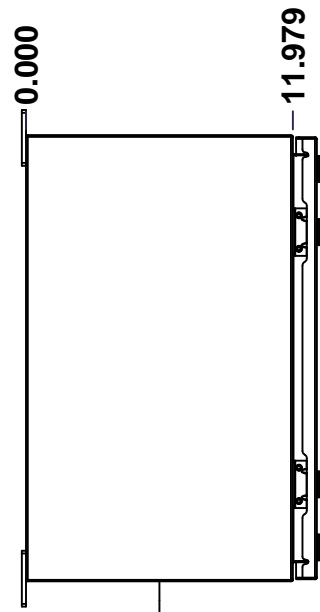

LEFT

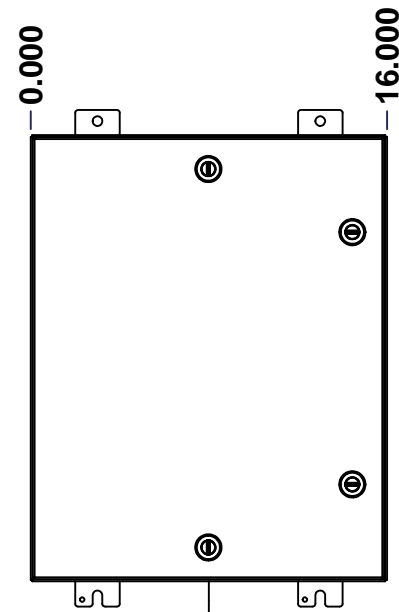

FRONT

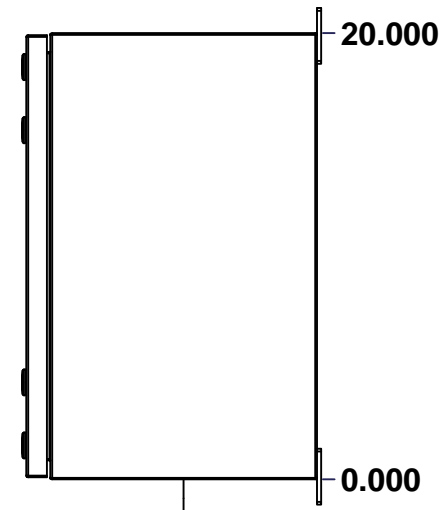

RIGHT

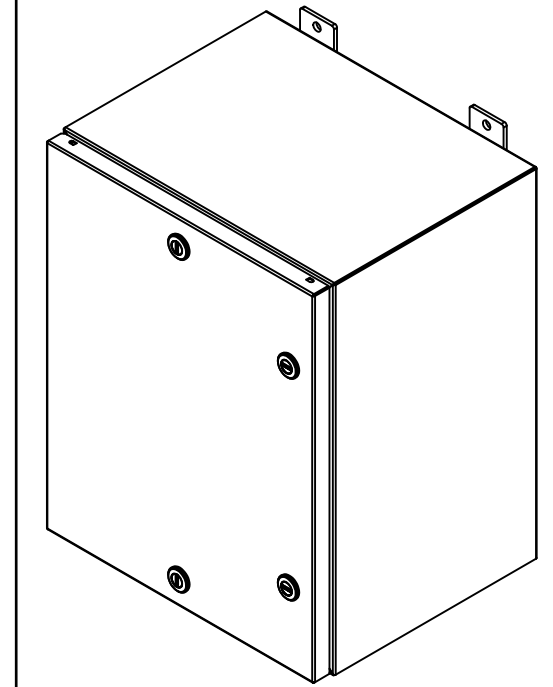

Isometric View

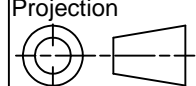

No.	Revisions	Date	By/Par

 Tél: (450) 979-4373 Fax: (450) 979-4626 <a href="http://www.exmweb.com">www.exmweb.com</a>		Flatness Aplatissement Max 3.0mm Projection 
Customer Client	Date	
Drawn By Dessiné Par	BoxCad: Annie	Date 29/04/2014
Material Matière	16 Ga H.R.P. & O. (1.4mm)	
Color Couleur	Asa-61 Grey	Finish Fini Smooth
Description	Detail Rev.	
5412ESPR 20" x 16" x 12" Assembly		
Part Number Numéro Pièce	Rev. 0	1 2

SEE BILL OF MATERIAL ON LAST PAGE

**5412ESPR201612**

This drawing is confidential and must not be reproduced or used without the consent of EXM

Ce dessin est confidentiel et ne doit pas être reproduit ou utilisé sans le consentement de EXM

NOTE	
ITEM	DESCRIPTION
1	NEMA 4/12 Enclosure
2	C/W Standard ground studs on box and cover
3	W/O Standard door stiffener
4	C/W Standard inner panel (Sold seperately)
5	C/W Standard inner panel mounting studs

No.	Revisions	Date	By/Par

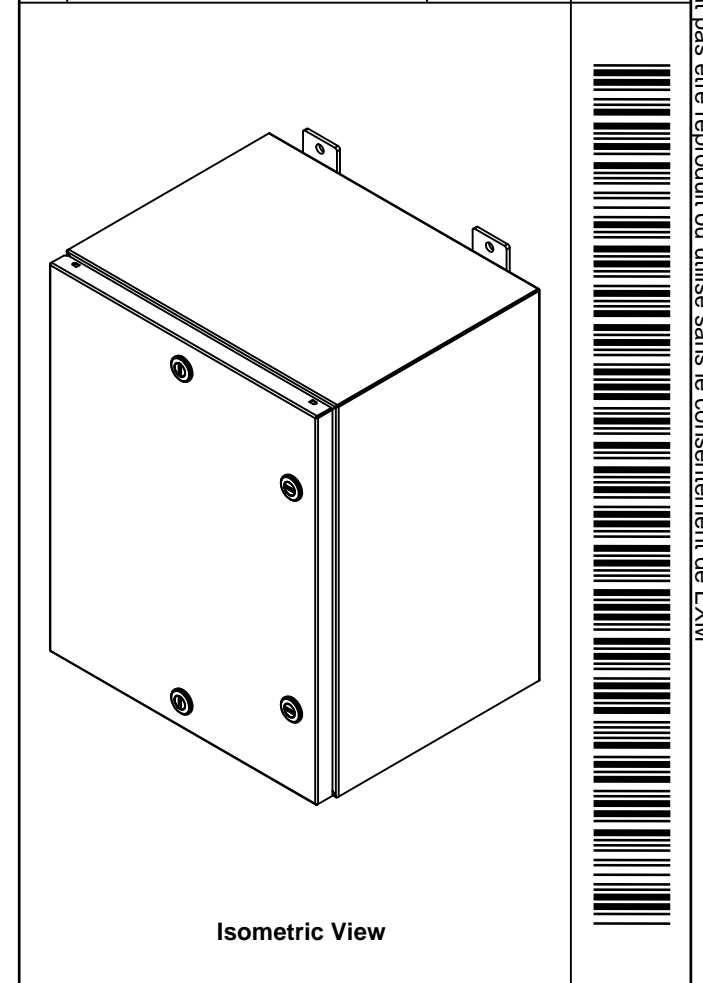

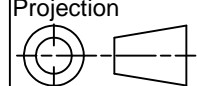
 Tél: (450) 979-4373 Fax: (450) 979-4626 <a href="http://www.exmweb.com">www.exmweb.com</a>		Flatness Aplatissement Max 3.0mm Projection 
Customer Client	Date	
Drawn By Dessiné Par	BoxCad: Annie	Date 29/04/2014
Material Matière	16 Ga H.R.P. & O. (1.4mm)	
Color Couleur	Asa-61 Grey	Finish Fini Smooth
Description	5412ESPR 20" x 16" x 12" Assembly	
Part Number Numéro Pièce	Rev. 0	2

Qty	Part Number	Rev	Description
1	880 PP	0	Self Adhesive Print Pocket
1	STK-K-01800	0	5412 ES Accessory Kit
4	STK-Q-03000	0	M5 x 8mm Phillips Flat Head Screw
1	881 SP2016	0	881 SP - Inner Panel
1	5412ESPR201612C	0	5412ESPR 20" x 16" Cover
4	STK-Q-07310	2	Flange Lock Nut M8
4	STK-Q-07610	7	M8 Plastic Spacer 22.2mm
1	5412ESPR201612B	0	5412ESPR 20" x 16" x 12" Body
Parts List			

This drawing is confidential and must not be reproduced or used without the consent of EXM

Ce dessin est confidentiel et ne doit pas être reproduit ou utilisé sans le consentement de EXM

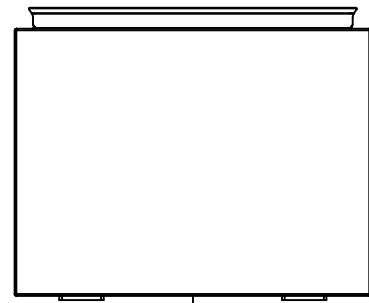

TOP

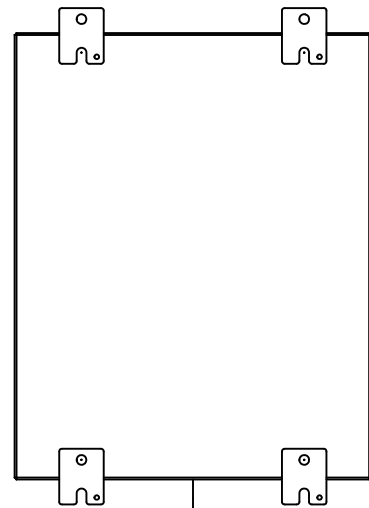

BACK

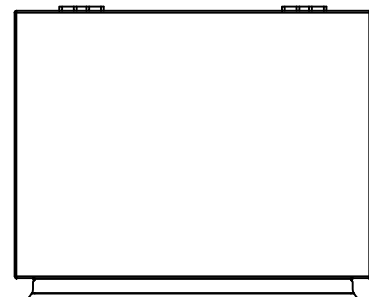

BOTTOM

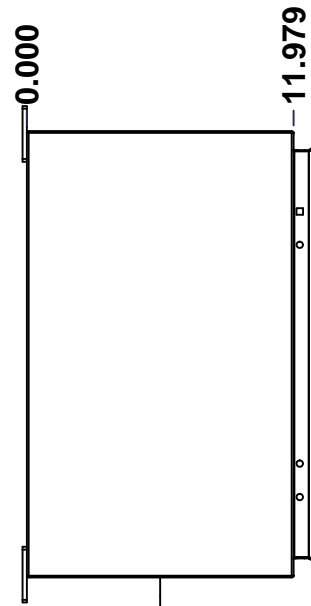

LEFT

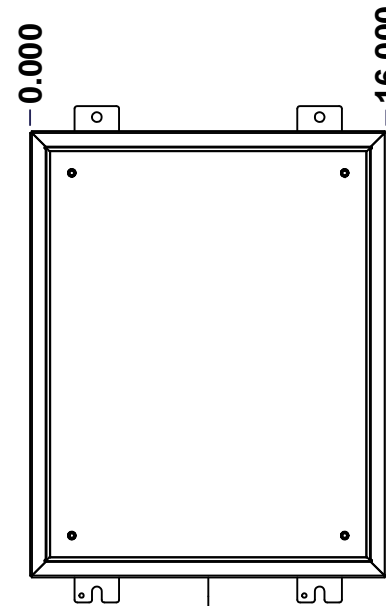

FRONT

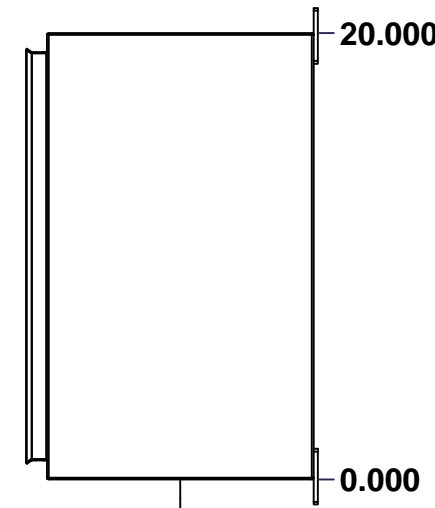

RIGHT

No.	Revisions	Date	By/Par

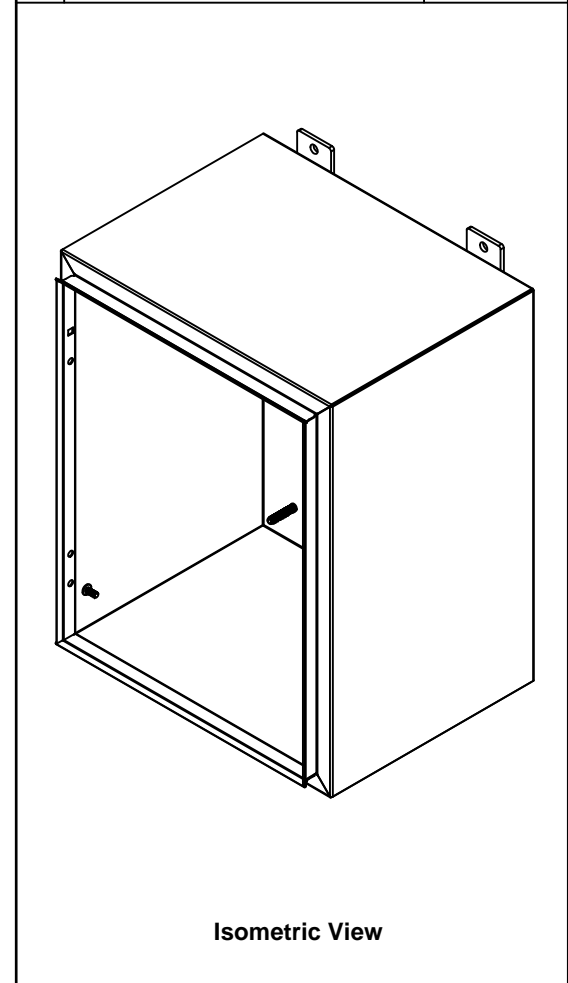

Isometric View

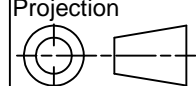

 Tél: (450) 979-4373 Fax: (450) 979-4626 <a href="http://www.exmweb.com">www.exmweb.com</a>		Flatness Aplatissement Max 3.0mm Projection 
Customer Client	Date	
Drawn By Dessiné Par	BoxCad: Annie	Date 29/04/2014
Material Matière	16 Ga H.R.P. & O. (1.4mm)	
Color Couleur	Asa-61 Grey	Finish Fini Smooth
Description	Detail Rev.	
5412ESPR 20" x 16" x 12" Body		
Part Number Numéro Pièce	Rev.	
<b>5412ESPR201612B</b>	<b>0</b>	1 / 7

SEE BILL OF MATERIAL ON LAST PAGE

This drawing is confidential and must not be reproduced or used without the consent of EXM

Ce dessin est confidentiel et ne doit pas être reproduit ou utilisé sans le consentement de EXM

STANDARD FEATURES ARE NOT LISTED IN THIS HOLE TABLE			
HOLE TABLE - LEFT VIEW (CUSTOM FEATURE ONLY)			
CUT-OUT	XDIM	YDIM	DESCRIPTION
1	10.500	2.000	GND STUD M6 x 16mm (Inside)

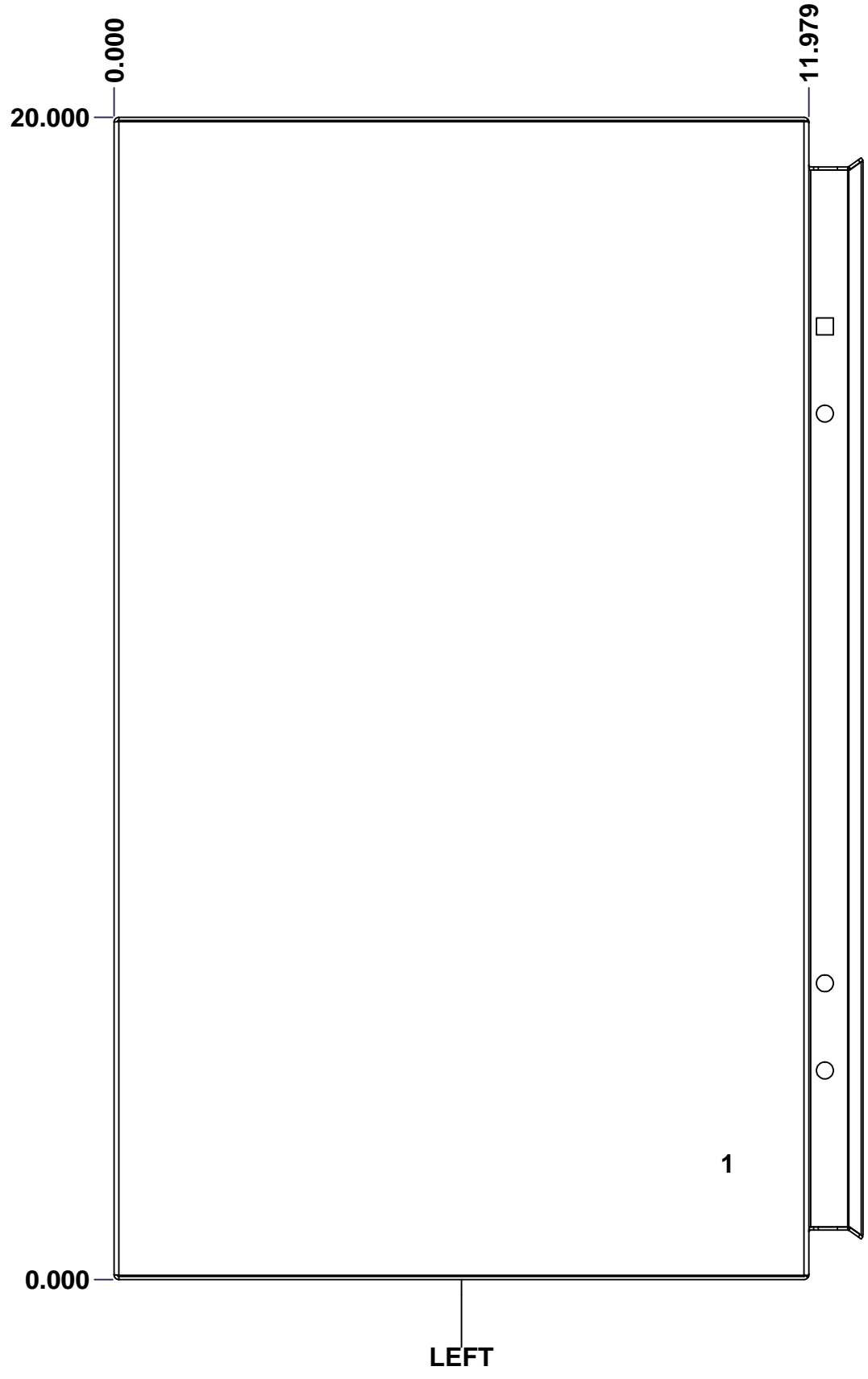

	Description	Status
	5412ESPR 20" x 16" x 12" Body	
	Part Number Numéro Pièce	Rev.
	<b>5412ESPR201612B</b>	<b>0</b>
		5 / 7

This drawing is confidential and must not be reproduced or used without the consent of EXM

Ce dessin est confidentiel et ne doit pas être reproduit ou utilisé sans le consentement de EXM

**STANDARD FEATURES ARE NOT LISTED IN THIS HOLE TABLE**

**HOLE TABLE - BACK VIEW (CUSTOM FEATURE ONLY)**

CUT-OUT	XDIM	YDIM	DESCRIPTION
1	1.875	1.875	IP STUD M8 x 35mm (Inside)
2	1.875	18.125	IP STUD M8 x 35mm (Inside)
3	14.125	18.125	IP STUD M8 x 35mm (Inside)
4	14.125	1.875	IP STUD M8 x 35mm (Inside)

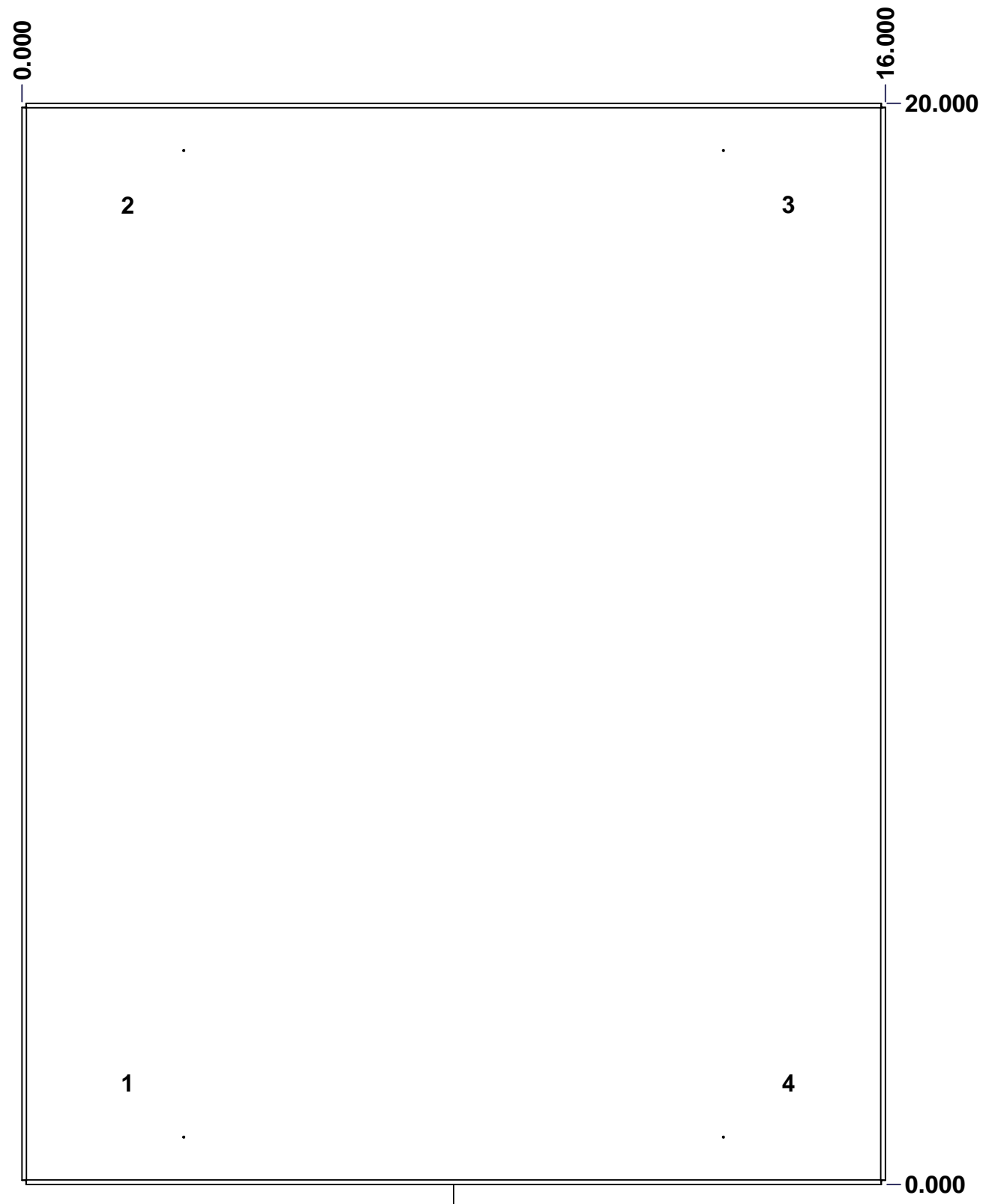

BACK

	Description		Status
	5412ESPR 20" x 16" x 12" Body		
	Part Number Numéro Pièce		Rev.
	<b>5412ESPR201612B</b>		<b>0</b>
			6 / 7

This drawing is confidential and must not be reproduced or used without the consent of EXM

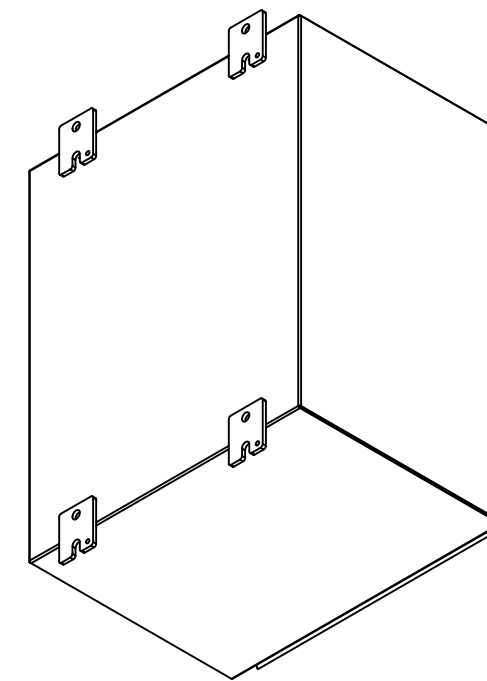

Ce dessin est confidentiel et ne doit pas être reproduit ou utilisé sans le consentement de EXM

No.	Revisions	Date	By/Par



Isometric View

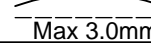

 Tél: (450) 979-4373 Fax: (450) 979-4626 <a href="http://www.exmweb.com">www.exmweb.com</a>		Flatness Aplatissement  Max 3.0mm Projection 	
Customer Client		Date	
Drawn By / Dessiné Par: BoxCad: Annie		Date: 29/04/2014	
Material / Matière: 16 Ga H.R.P. & O. (1.4mm)			
Color / Couleur: Asa-61 Grey		Finish / Fini: Smooth	
Description: 5412ESPR 20" x 16" x 12" Body			Detail Rev.
Part Number / Numéro Pièce: <b>5412ESPR201612B</b>		Rev.:	7
		<b>0</b>	7

Qty	Part Number	Rev	Description
1	STK-P-02400S	0	Powder Paint (Asa-61 Grey / Smooth)
4	STK-Q-71000	0	Steel Mounting Tab
4	STK-Q-16005	1	Stud M8 x 35 (No Paint Cap Required)
1	STK-Q-16080	0.1.1	M6 x 16mm Ground Stud
1	5412ESPR201612B-P	0	5412ESPR 20" x 16" x 12" Body Part
Parts List			

This drawing is confidential and must not be reproduced or used without the consent of EXM

Ce dessin est confidentiel et ne doit pas être reproduit ou utilisé sans le consentement de EXM

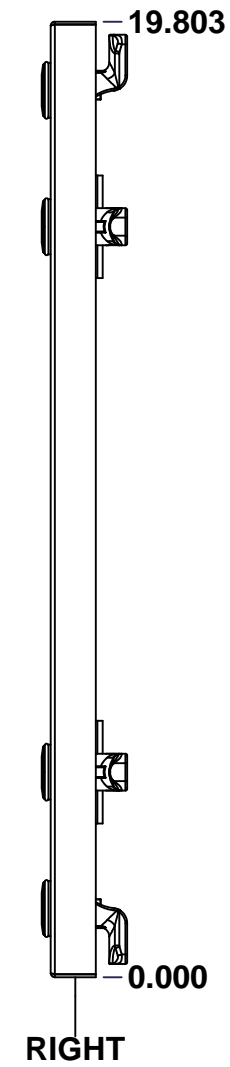
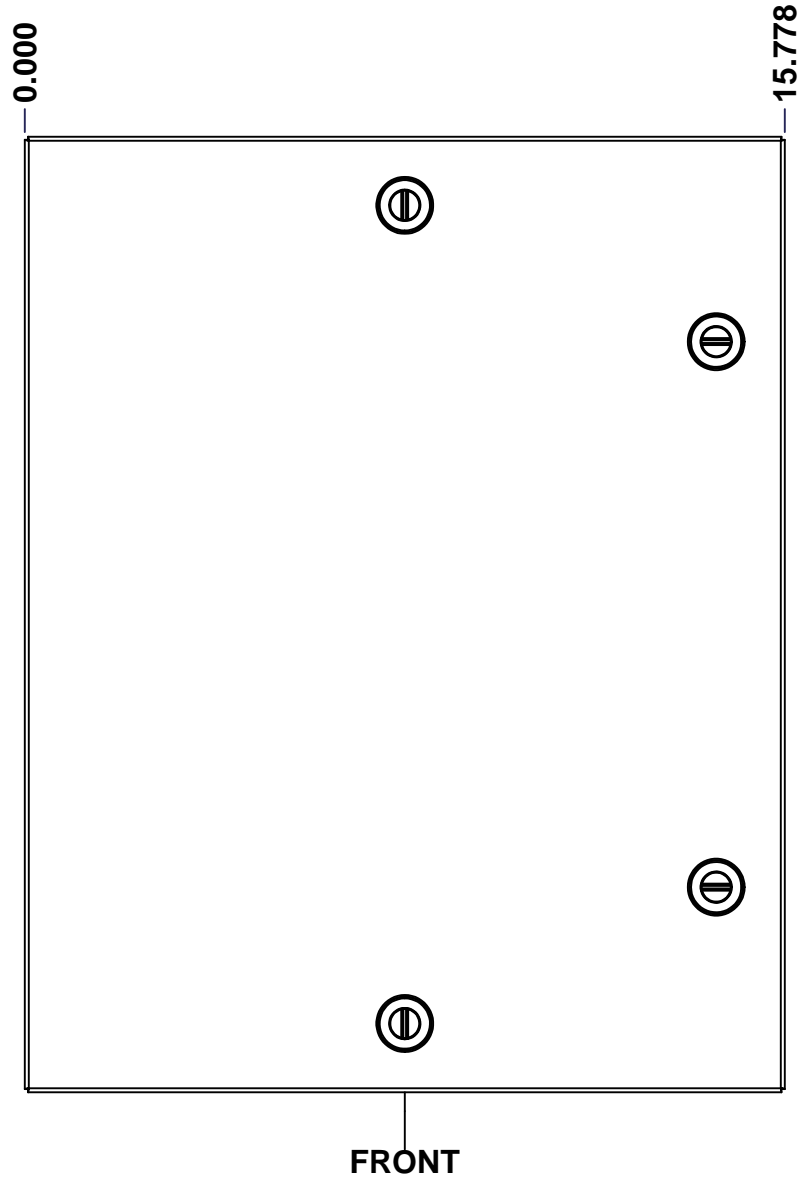
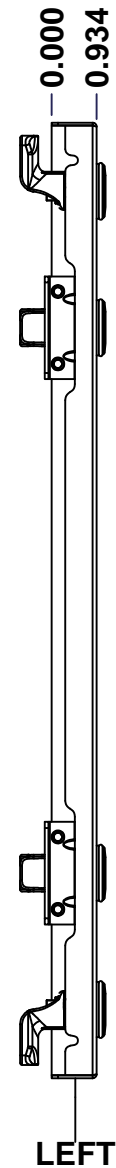
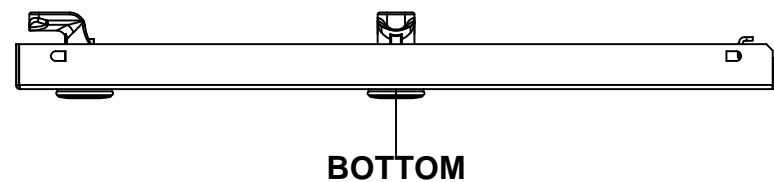
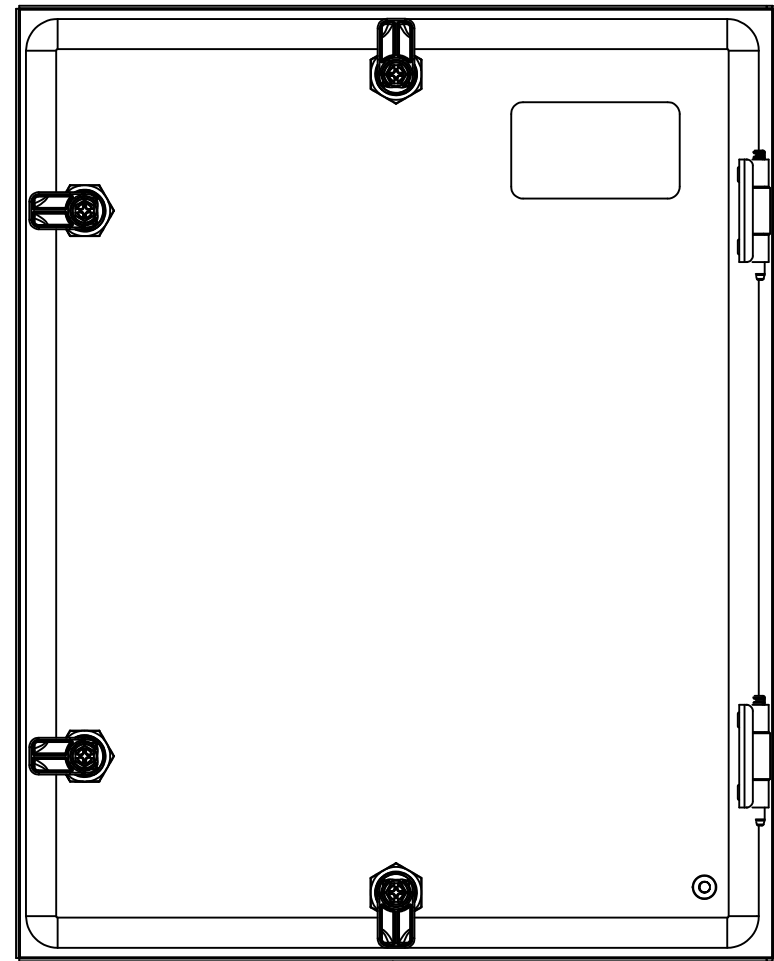
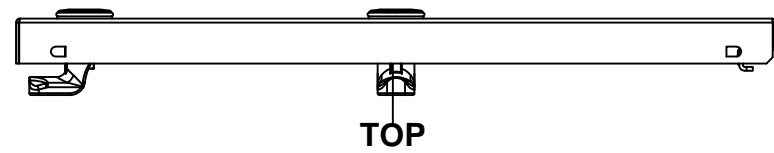

No.	Revisions	Date	By/Par

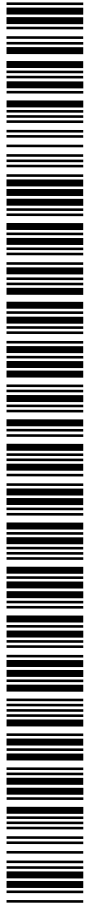
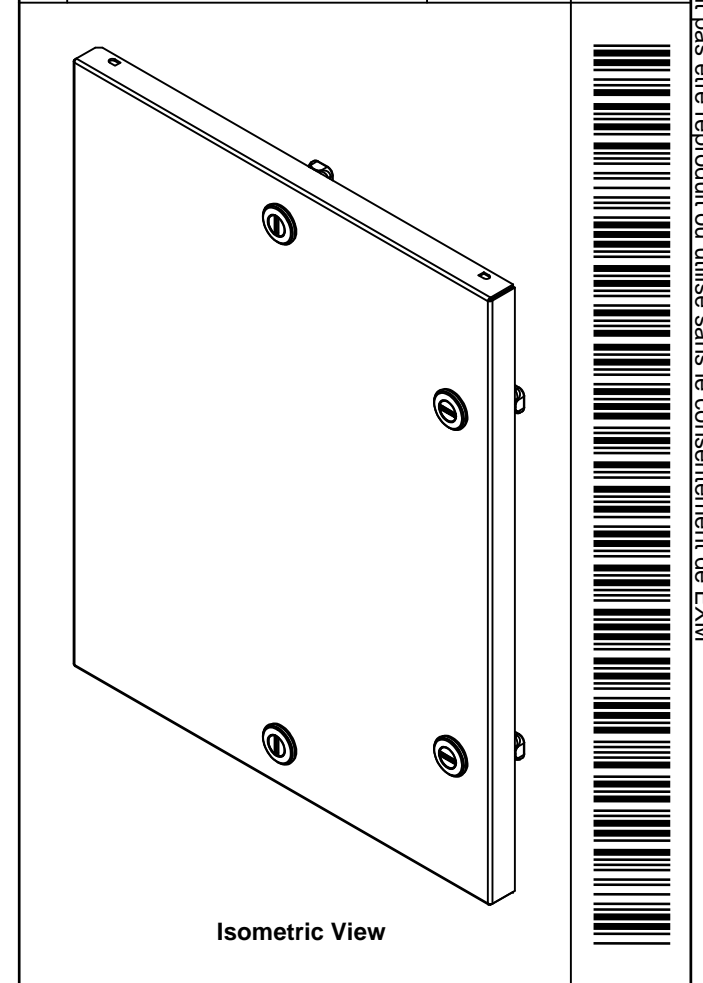

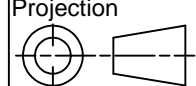
 Tél: (450) 979-4373 Fax: (450) 979-4626 <a href="http://www.exmweb.com">www.exmweb.com</a>		Flatness Aplatissement	
		Max 3.0mm	
Customer Client		Date	
Drawn By Dessiné Par BoxCad: Annie		Date 29/04/2014	
Material Matière 16 Ga H.R.P. & O. (1.4mm)		Projection	
Color Couleur Asa-61 Grey		 Finish Fini Smooth	
Description 5412ESPR 20" x 16" Cover		Detail Rev.	
Part Number Numéro Pièce <b>5412ESPR201612C</b>		Rev. <b>0</b>	1 3

**SEE BILL OF MATERIAL ON LAST PAGE**

This drawing is confidential and must not be reproduced or used without the consent of EXM

Ce dessin est confidentiel et ne doit pas être reproduit ou utilisé sans le consentement de EXM

STANDARD FEATURES ARE NOT LISTED IN THIS HOLE TABLE			
HOLE TABLE - FRONT VIEW (CUSTOM FEATURE ONLY)			
CUT-OUT	XDIM	YDIM	DESCRIPTION
1	1.486	1.535	GND STUD M6 x 16mm (Inside)

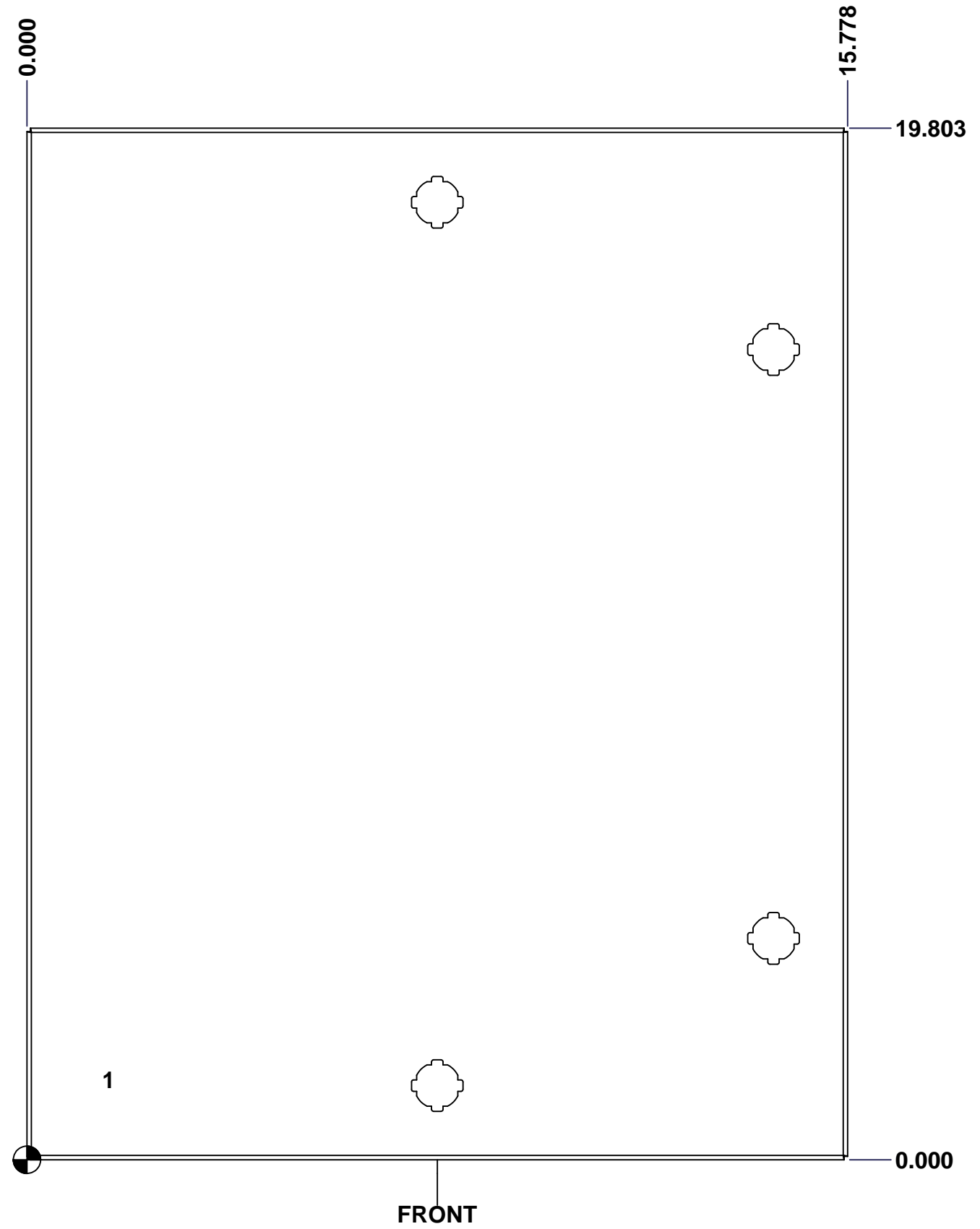

	Description	Status
	5412ESPR 20" x 16" Cover	(NULL)
	Part Number Numéro Pièce	Rev.
	<b>5412ESPR201612C</b>	<b>0</b>
		2
		3



This drawing is confidential and must not be reproduced or used without the consent of EXM

Ce dessin est confidentiel et ne doit pas être reproduit ou utilisé sans le consentement de EXM

No.	Revisions	Date	By/Par

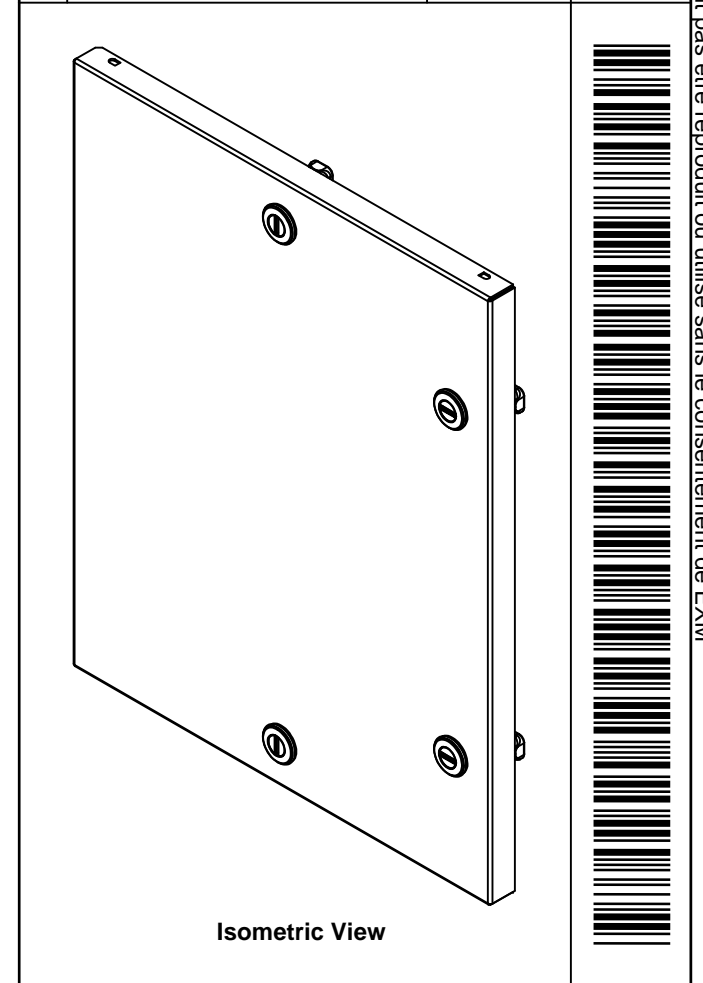

Qty	Part Name	Rev	Description
1	STK-Q-16080	0.1.	M6 x 16mm Ground Stud
		1	
2	STK-Q-33105	4	5412 ESBU Buttable Hinge (Cover Part)
1	STK-P-02400S	0	Powder Paint (Asa-61 Grey / Smooth)
1	STK-S-00100	0.1.	3.5" x 2" Silver Milar Flexcon Sticker
		1	
1	5412ESPR201612G	0	5412ESPR 20" x 16" Cover Gasket
1	5412ESPR201612C-P	0	5412ESPR 20" x 16" Cover Part
4	880 SCQ4-SL	0	5412 ES 1/4 Turn Lock
2	STK-A-33005	1	5412 ESBU Hinge 180° (Body Part)

Parts List

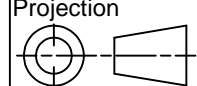
 Tél: (450) 979-4373 Fax: (450) 979-4626 <a href="http://www.exmweb.com">www.exmweb.com</a>		Flatness Aplatissement Max 3.0mm Projection 
Customer Client	Date	
Drawn By Dessiné Par	BoxCad: Annie	Date 29/04/2014
Material Matière	16 Ga H.R.P. & O. (1.4mm)	
Color Couleur	Asa-61 Grey	Finish Fini Smooth
Description	Detail Rev.	
5412ESPR 20" x 16" Cover		
Part Number Numéro Pièce	Rev.	3
<b>5412ESPR201612C</b>	<b>0</b>	<b>3</b>

This drawing is confidential and must not be reproduced or used without the consent of EXM

Ce dessin est confidentiel et ne doit pas être reproduit ou utilisé sans le consentement de EXM

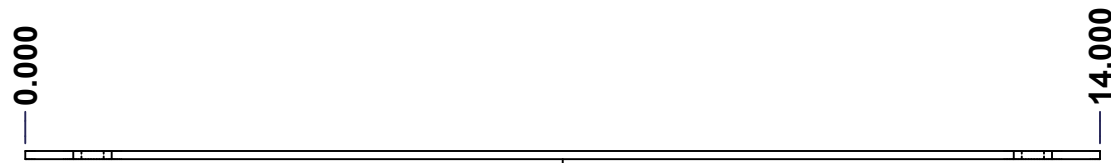

TOP

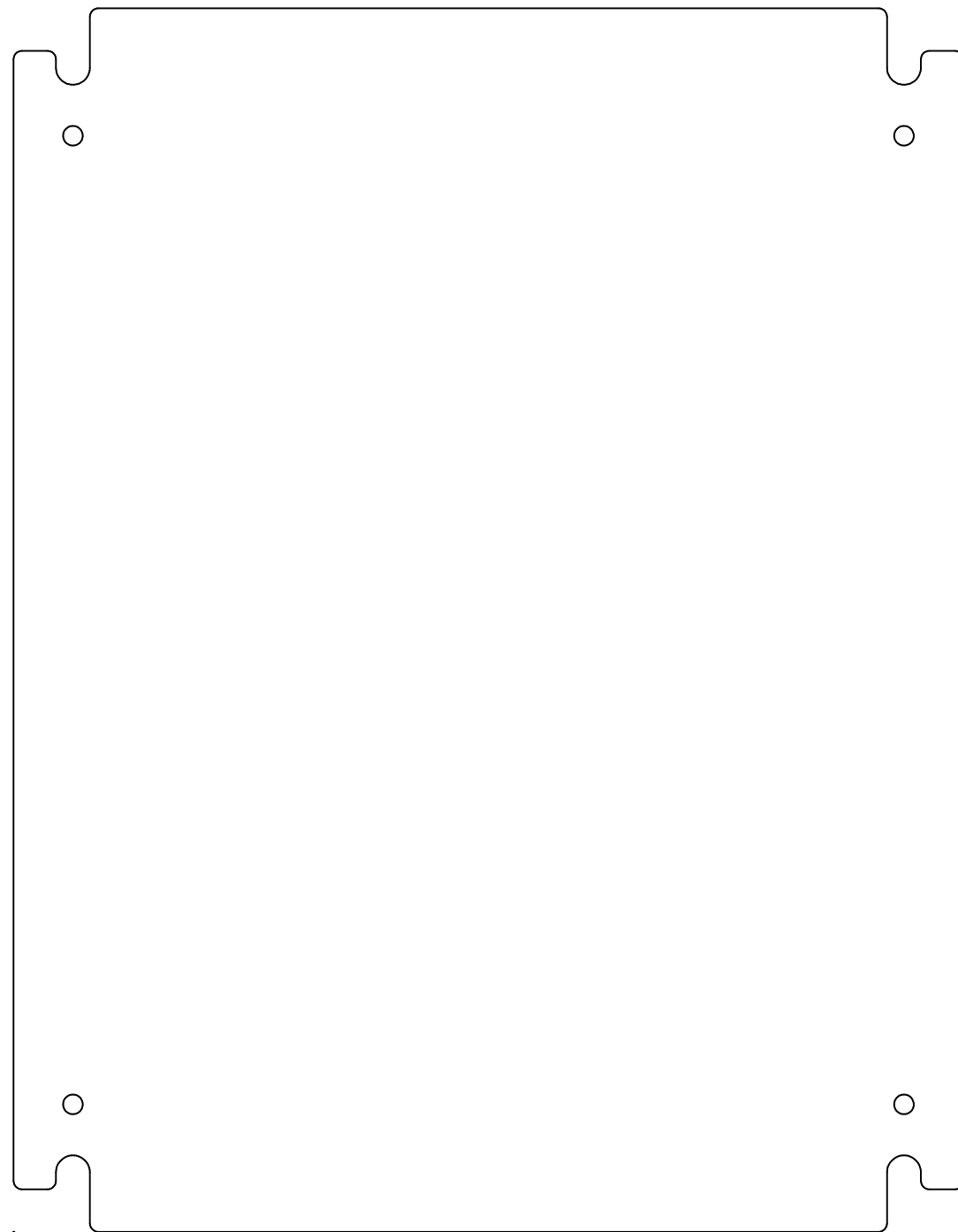

FRONT

18.000

0.000

RIGHT

No.	Revisions	Date	By/Par

**Isometric View**

		Tél: (450) 979-4373 Fax: (450) 979-4626 www.exmweb.com		Flatness Aplatissement Max 3.0mm Projection 	
Customer Client			Date		
Drawn By / Dessiné Par: BoxCad			Date: 1/23/2007		
Material / Matière: See Part List					
Color / Couleur: See Part List			Finish / Fini: See Part List		
Description: 881 SP - Inner Panel					Detail Rev.
Part Number / Numéro Pièce: <b>881 SP2016</b>					Rev. 0
					1 2

Qty	Part Number	Rev	Description	Material	Color	Finish
1	STK-P-02401S	0	Powder Paint (White / Smooth)	Polyester-Epoxy Hybrid	White RAL9003	Smooth
1	881 SP2016-P	0	881 SP - Inner Panel Part	12 Ga H.R.P. & O.	White	Smooth

Parts List

This drawing is confidential and must not be reproduced or used without the consent of EXM

Ce dessin est confidentiel et ne doit pas être reproduit ou utilisé sans le consentement de EXM

Table 1			FRONT VIEW
CUT-OUT	XDIM	YDIM	DESCRIPTION
1	0.875	1.875	GROUND HOLE (RND Ø0.290)
2	13.125	1.875	GROUND HOLE (RND Ø0.290)
3	0.875	16.125	GROUND HOLE (RND Ø0.290)
4	13.125	16.125	GROUND HOLE (RND Ø0.290)

All knockouts are actual size / Les disques défonçables sont grandeur réel

No.	Revisions	Date	By/Par

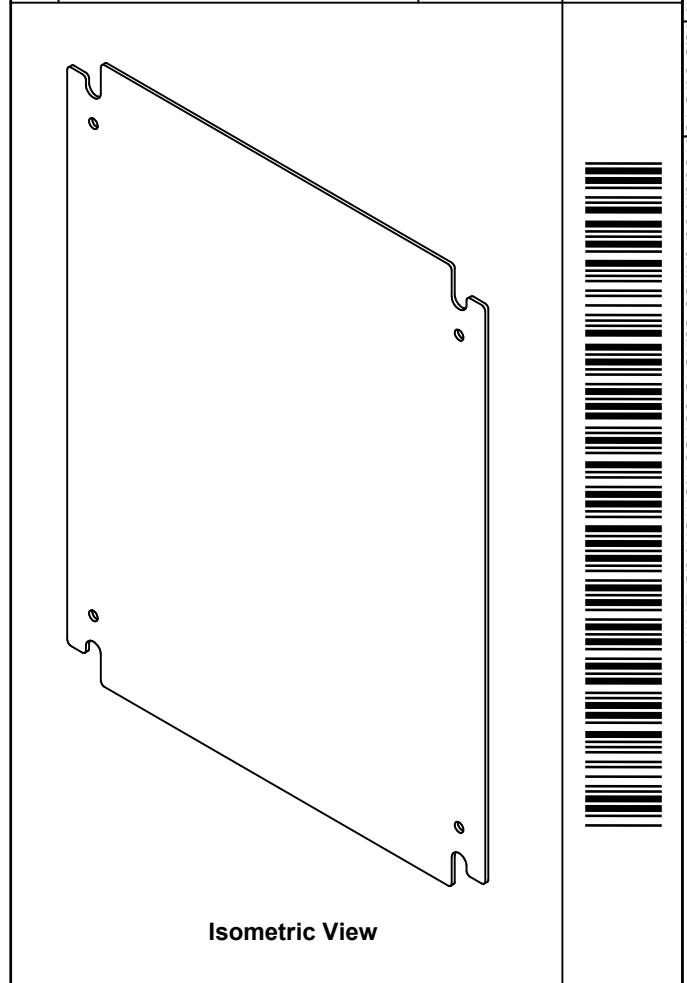
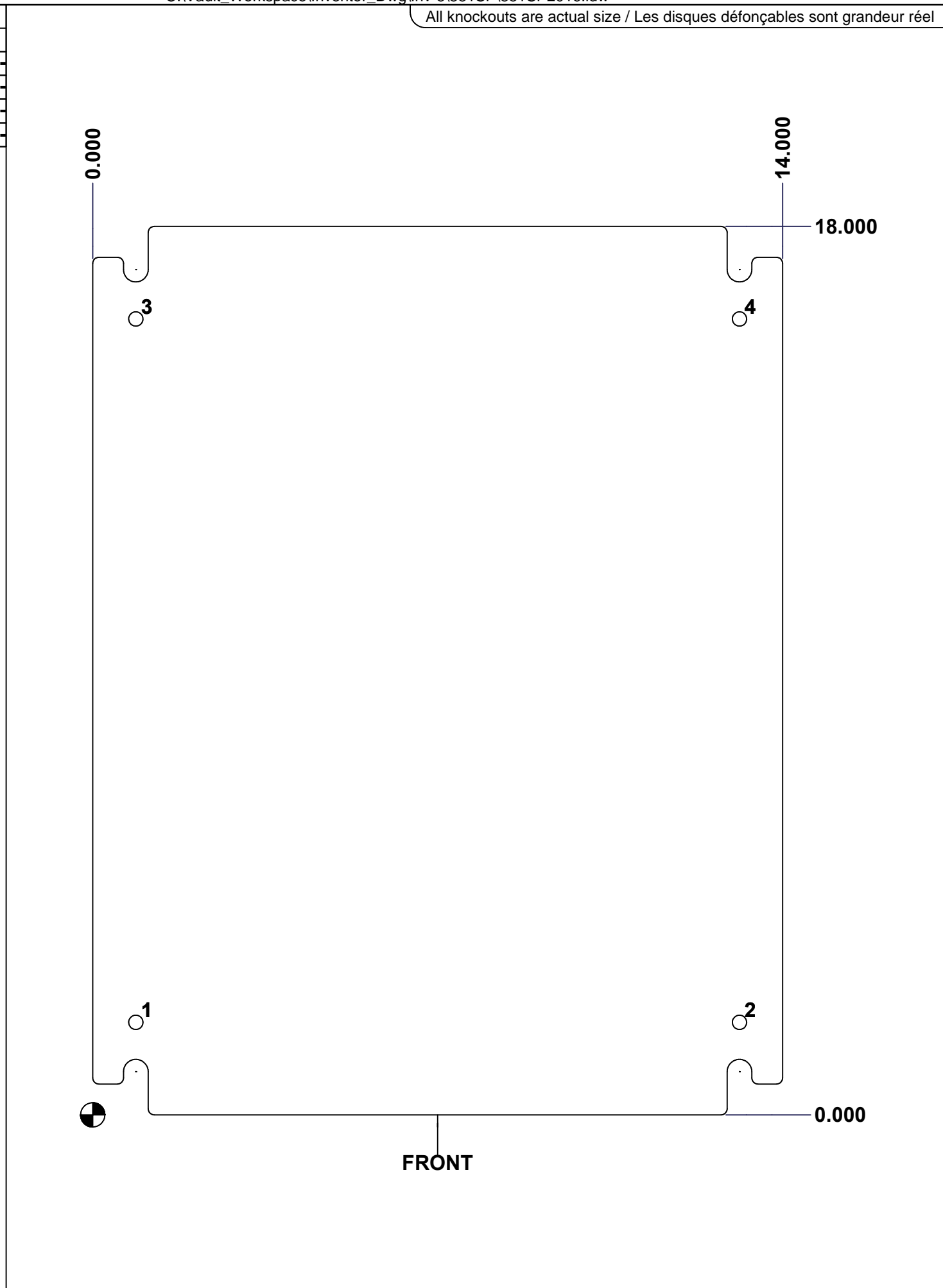

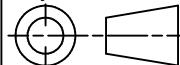
 Tél: (450) 979-4373 Fax: (450) 979-4626 www.exmweb.com		Flatness Aplatissement Max 3.0mm
Customer Client		Projection 
Drawn By Dessiné Par BoxCad		Date 1/23/2007
Material Matière See Part List		
Color Couleur See Part List	Finish Fini See Part List	
Description 881 SP - Inner Panel		Detail Rev.
Part Number Numéro Pièce <b>881 SP2016</b>		Rev. 2 <b>0</b>