

This drawing is confidential and must not be reproduced or used without the consent of EXM

Ce dessin est confidentiel et ne doit pas être reproduit ou utilisé sans le consentement de EXM

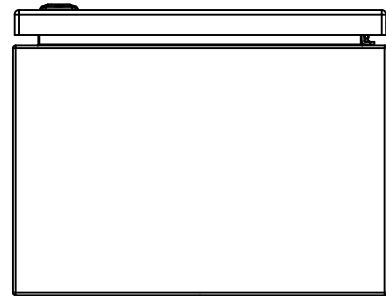

TOP

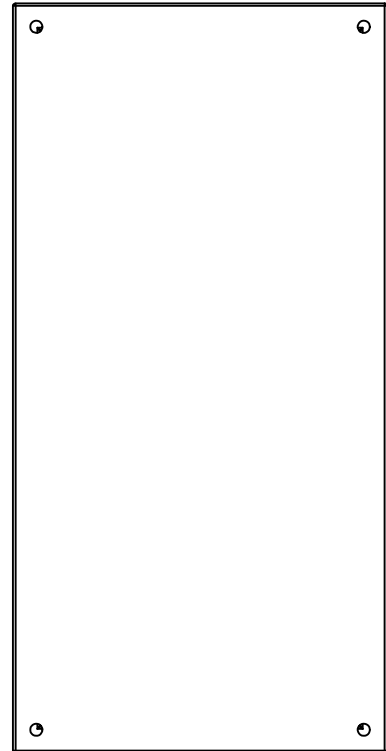

BACK

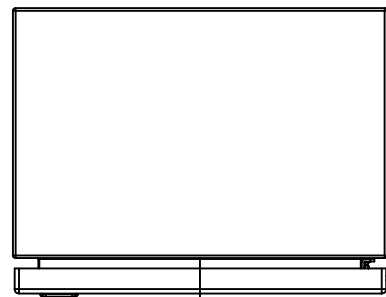

BOTTOM

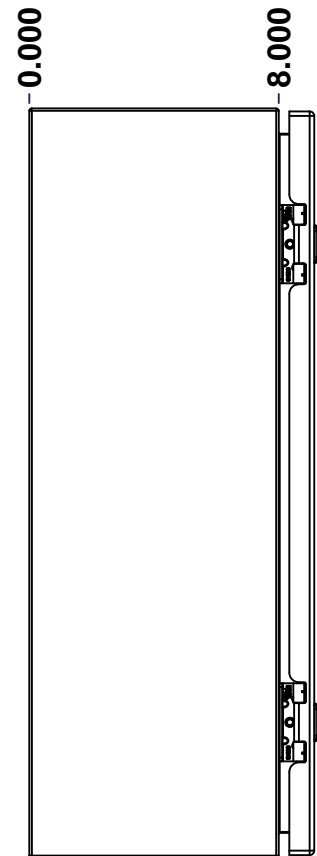

LEFT

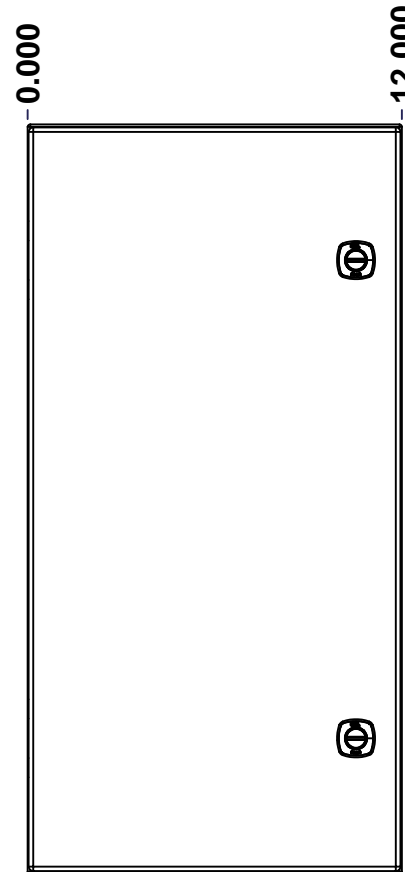

FRONT

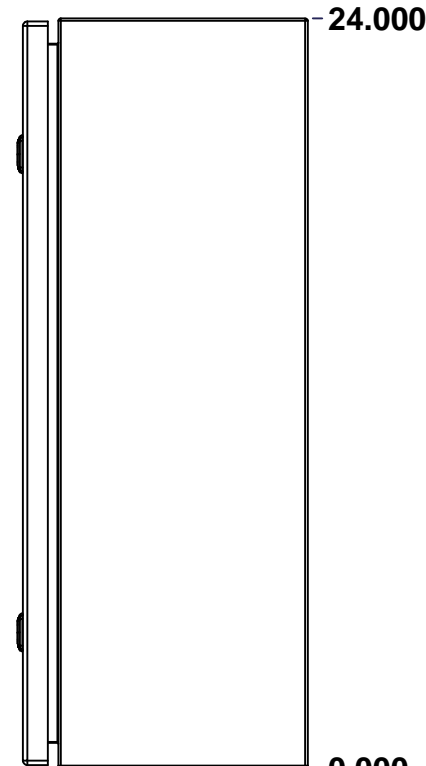

RIGHT

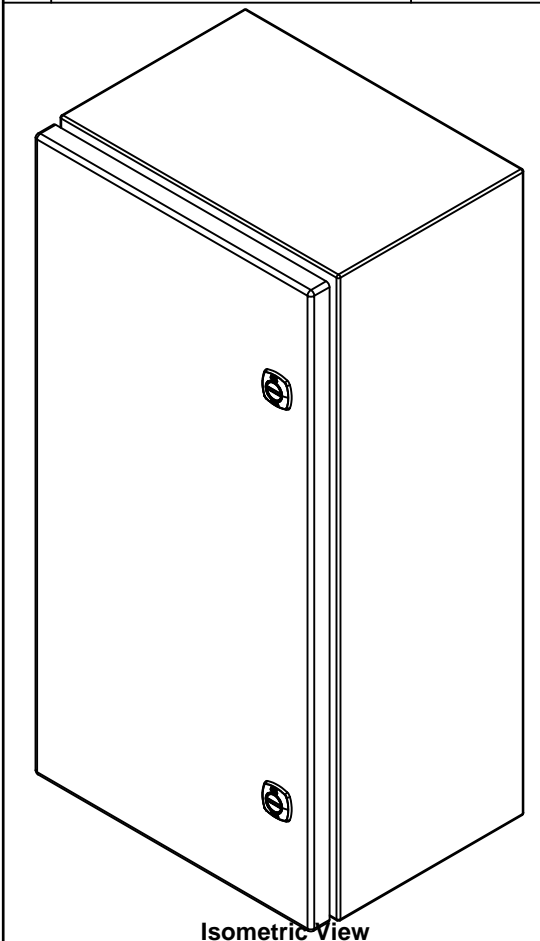

Isometric View



**GRAIN DIRECTION:
TOP/BOTTOM: HORIZONTAL
LEFT/RIGHT/BACK/FRONT: VERTICAL**

SEE BILL OF MATERIAL ON LAST PAGE

No.	Revisions	Date	By/Par

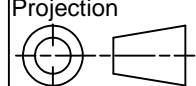
 Tél: (450) 979-4373 Fax: (450) 979-4626 www.exmweb.com		Flatness Aplatissement Max 3.0mm Projection 
Customer Client	Date	Date
Drawn By Dessiné Par	BoxCad: BoxCad	Date 03-May-22
Material Matière	16 Ga Stainless Steel 316 (1.4mm)	
Color Couleur	Unpainted	Finish Fini Brushed
Description	Detail Rev.	
5412ESS 24" x 12" x 8" Assembly		
Part Number Numéro Pièce	Rev.	1
5412ESS2412086NOIP	0	2

This drawing is confidential and must not be reproduced or used without the consent of EXM

Ce dessin est confidentiel et ne doit pas être reproduit ou utilisé sans le consentement de EXM

NOTE	
ITEM	DESCRIPTION
1	NEMA 4X Enclosure
2	C/W Standard ground studs on box and cover
3	C/W Standard door stiffener
4	W/O Inner panel
5	C/W Standard inner panel mounting studs

No.	Revisions	Date	By/Par

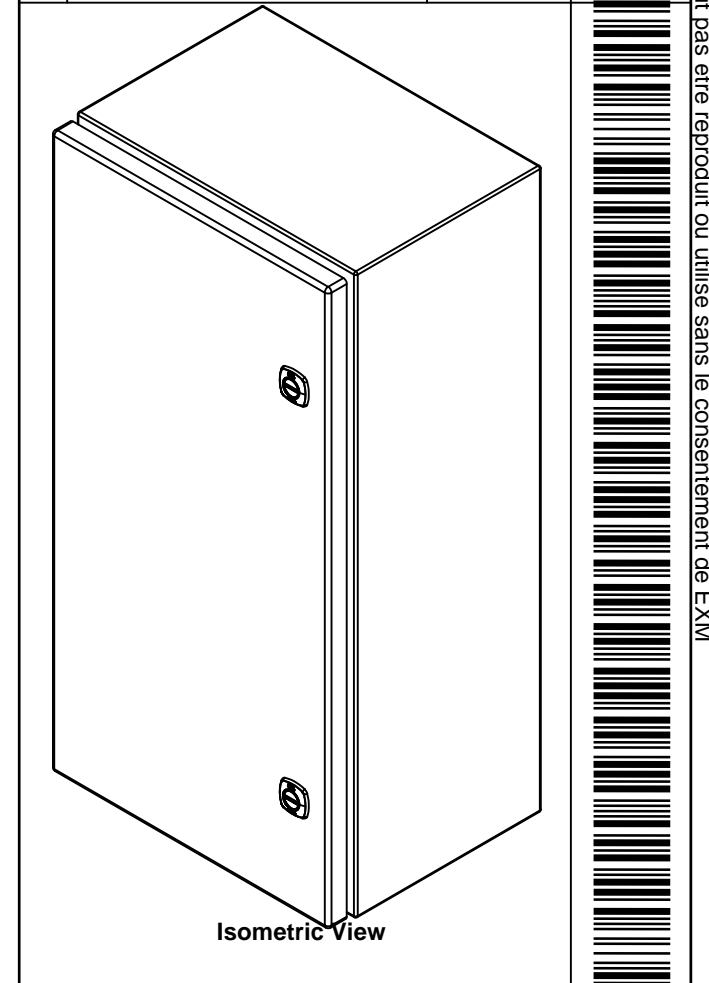

PACKING		
ITEM	QTY	DESCRIPTION
Cardboard sleeve	2	Top and Bottom
Cardboard strip	2	Between back of enclosure and inner panel
Plastic bag	1	To protect cover surface and inside gasket
Plastic strap - Black	2	To Squeeze the 2 cardboard sleeve together
Packaging label	1	White label with product number

1	STK-K-01800	5	5412 ES Accessory Kit
1	5412ESS2412086NOIPC	0	5412ESS 24" x 12" Cover
1	5412ESS2412086NOIPB	0	5412ESS 24" x 12" x 8" Body
2	STK-Q-04051-07	8	M6 x 7mm Stainless Steel Hexagon Socket Head Machine Screw with Nyseal
Qty	Part Number	Rev	Description
Parts List			

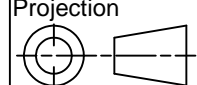
 Tél: (450) 979-4373 Fax: (450) 979-4626 www.exmweb.com		Flatness Aplatissement Max 3.0mm Projection 
Customer Client	Date	
Drawn By Dessiné Par	BoxCad: BoxCad	Date 03-May-22
Material Matière	16 Ga Stainless Steel 316 (1.4mm)	
Color Couleur	Unpainted	Finish Fini Brushed
Description	Detail Rev.	
5412ESS 24" x 12" x 8" Assembly		
Part Number Numéro Pièce	Rev.	2
5412ESS2412086NOIP	0	2

This drawing is confidential and must not be reproduced or used without the consent of EXM

Ce dessin est confidentiel et ne doit pas être reproduit ou utilisé sans le consentement de EXM

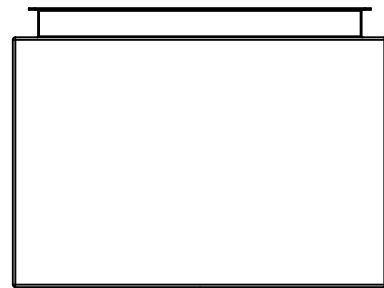

TOP

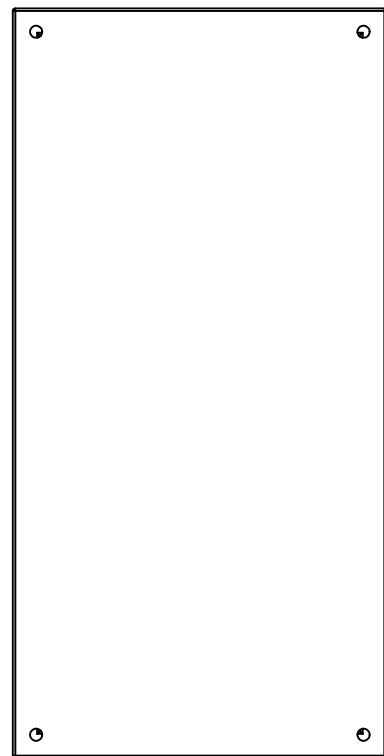

BACK

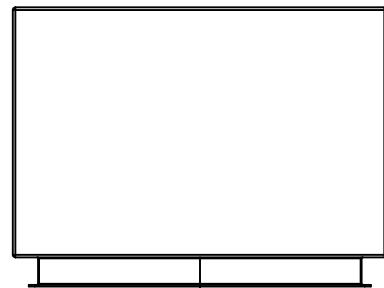

BOTTOM

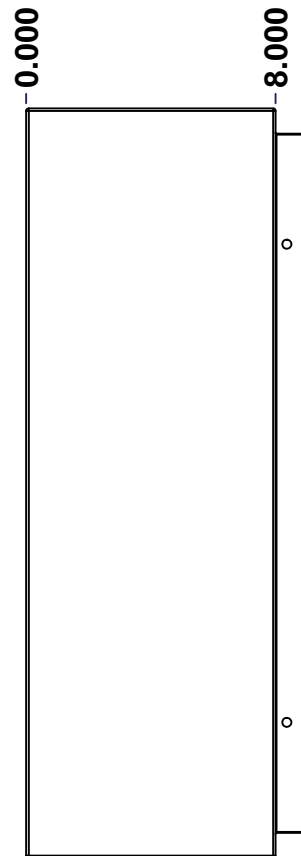

LEFT

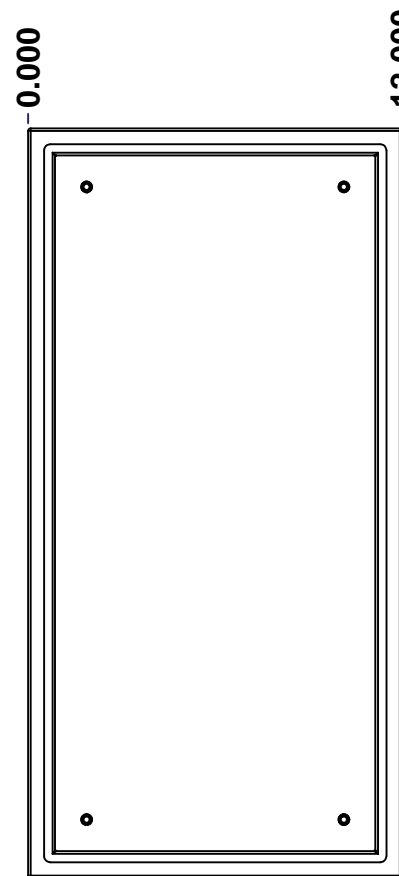

FRONT

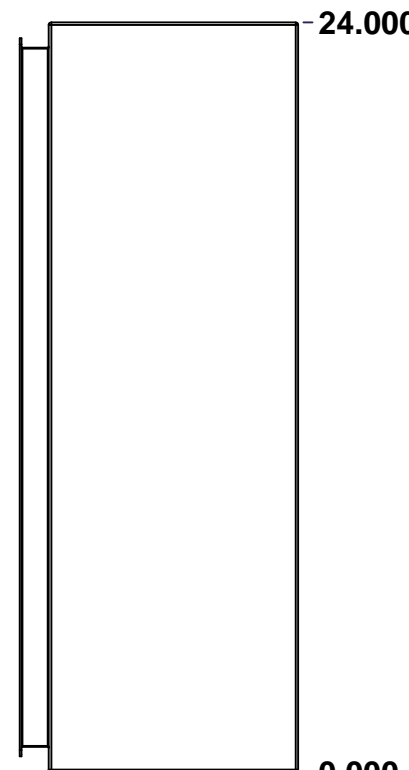

RIGHT

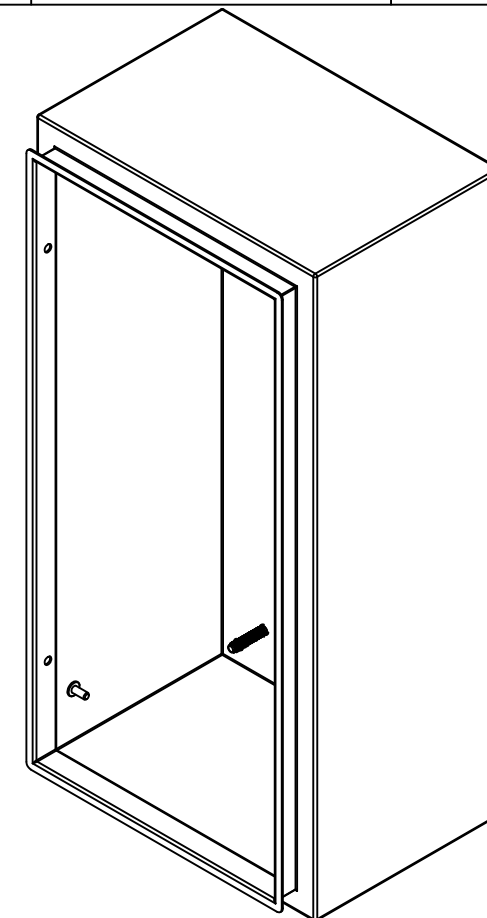

Isometric View

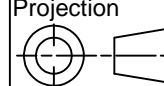

No.	Revisions	Date	By/Par

 Tél: (450) 979-4373 Fax: (450) 979-4626 www.exmweb.com		Flatness Aplatissement Max 3.0mm Projection 
Customer Client	Date	
Drawn By Dessiné Par	BoxCad: BoxCad	Date 03-May-22
Material Matière	16 Ga Stainless Steel 316 (1.4mm)	
Color Couleur	Unpainted	Finish Fin Brushed
Description	Detail Rev.	
5412ESS 24" x 12" x 8" Body		
Part Number Numéro Pièce	Rev.	
5412ESS2412086NOIPB	0	1 / 7

SEE BILL OF MATERIAL ON LAST PAGE

This drawing is confidential and must not be reproduced or used without the consent of EXM

Ce dessin est confidentiel et ne doit pas être reproduit ou utilisé sans le consentement de EXM

STANDARD FEATURES ARE NOT LISTED IN THIS HOLE TABLE			
HOLE TABLE - LEFT VIEW (CUSTOM FEATURE ONLY)			
CUT-OUT	XDIM	YDIM	DESCRIPTION
1	6.500	2.000	GND STUD M6 x 16mm (Inside)

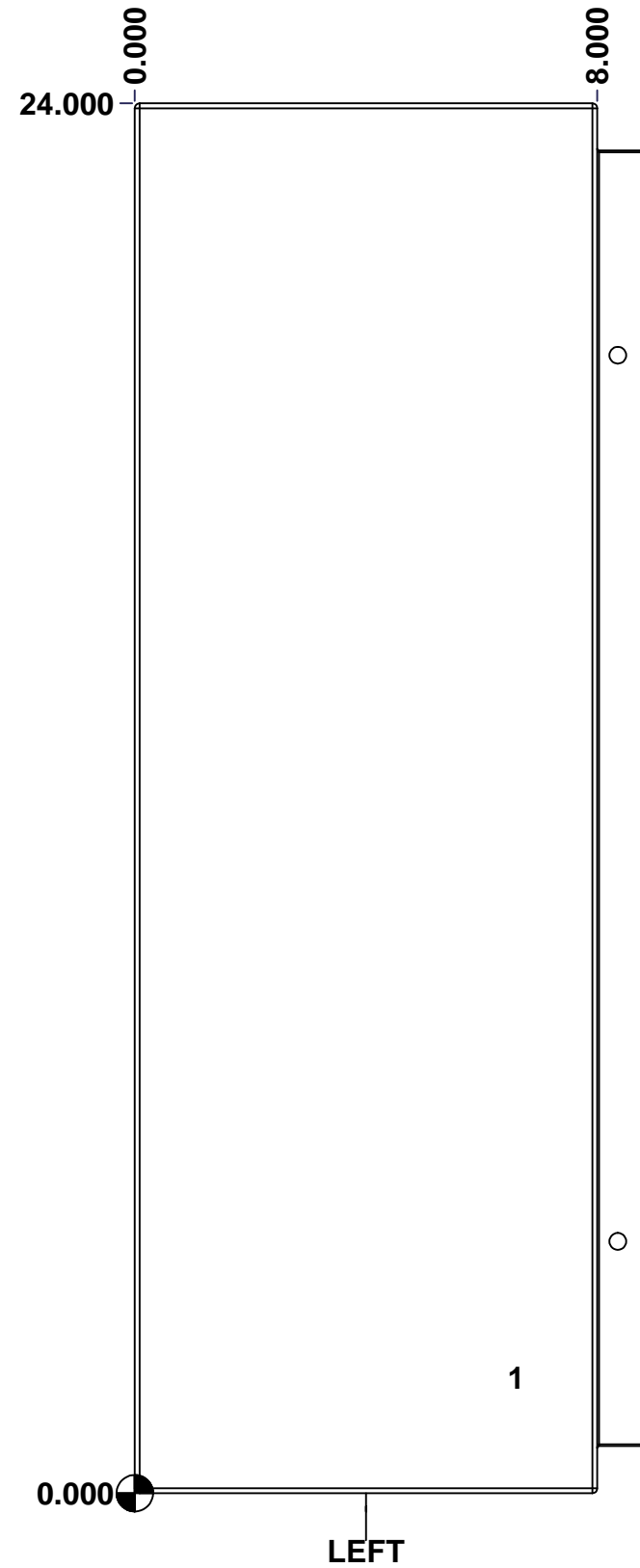

	Description	Status	
	5412ESS 24" x 12" x 8" Body		
	Part Number Numéro Pièce	Rev.	5 / 7
	5412ESS2412086NOIPB	0	

This drawing is confidential and must not be reproduced or used without the consent of EXM

Ce dessin est confidentiel et ne doit pas être reproduit ou utilisé sans le consentement de EXM

STANDARD FEATURES ARE NOT LISTED IN THIS HOLE TABLE

HOLE TABLE - BACK VIEW (CUSTOM FEATURE ONLY)

CUT-OUT	XDIM	YDIM	DESCRIPTION
1	1.875	1.875	IP STUD M8 x 35mm (Inside)
2	1.875	22.125	IP STUD M8 x 35mm (Inside)
3	10.125	22.125	IP STUD M8 x 35mm (Inside)
4	10.125	1.875	IP STUD M8 x 35mm (Inside)

5	0.750	0.750	RND Ø0.390
6	11.250	0.750	RND Ø0.390
7	11.250	23.250	RND Ø0.390
8	0.750	23.250	RND Ø0.390

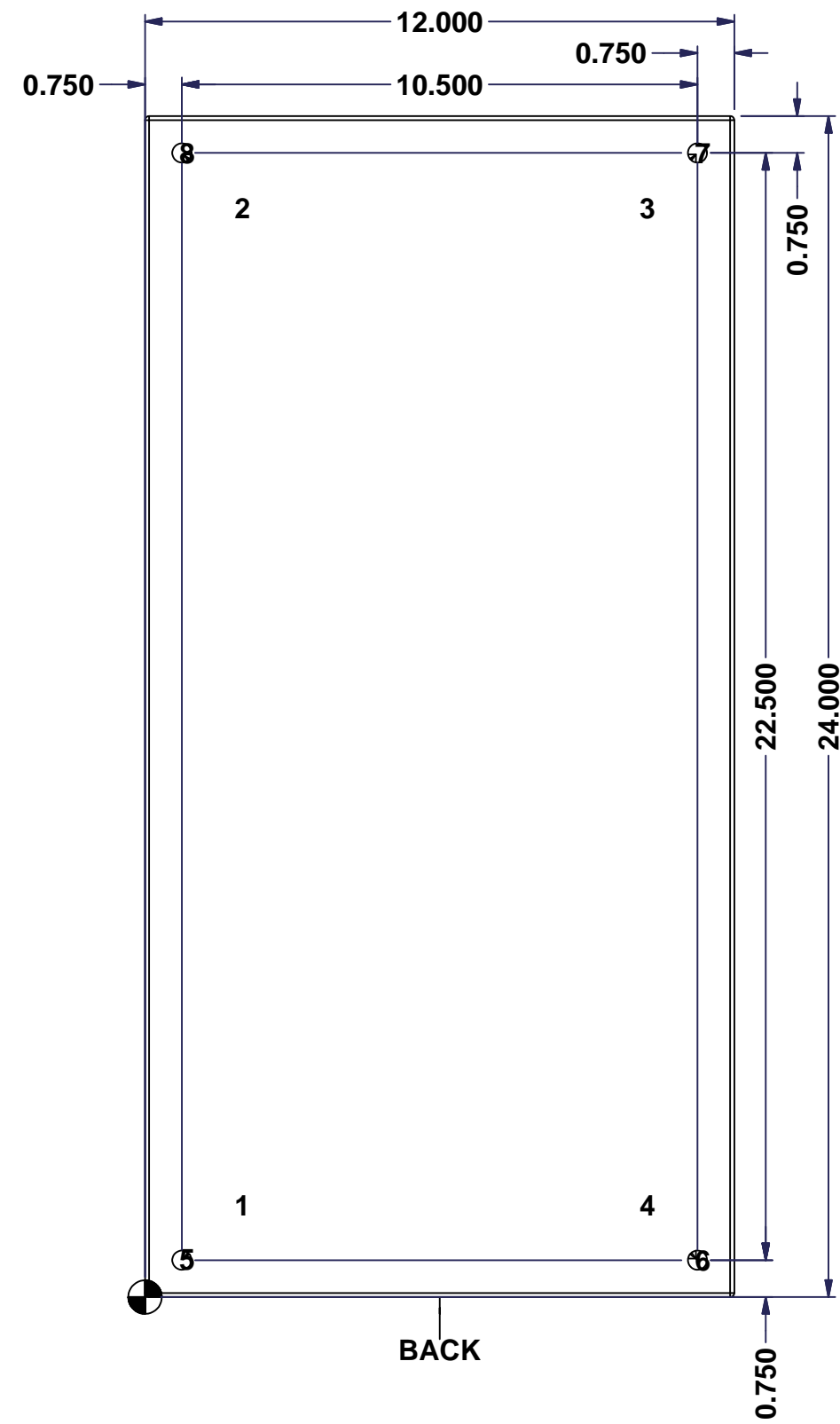

	Description	Status
	5412ESS 24" x 12" x 8" Body	
	Part Number Numéro Pièce	Rev.
	5412ESS2412086NOIPB	0
		6
		7

This drawing is confidential and must not be reproduced or used without the consent of EXM

Ce dessin est confidentiel et ne doit pas être reproduit ou utilisé sans le consentement de EXM

No.	Revisions	Date	By/Par

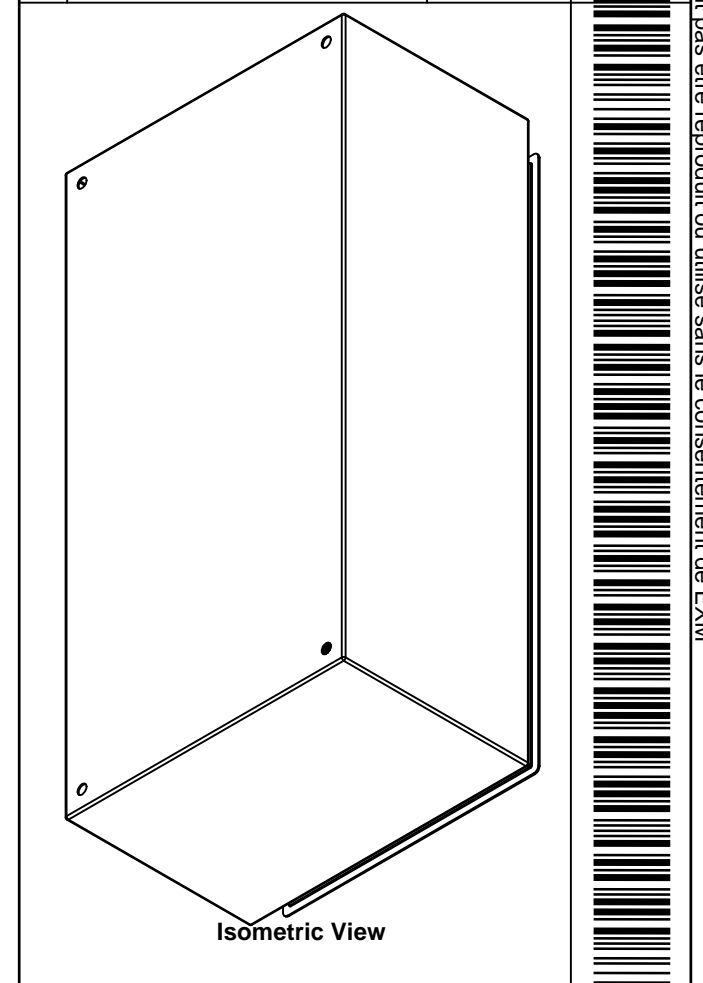

 Tél: (450) 979-4373
 Fax: (450) 979-4626
www.exmweb.com

Flatness / Aplatissement: Max 3.0mm
 Projection: 

Customer Client	Date
Drawn By / Dessiné Par: BoxCad: BoxCad	Date: 03-May-22
Material / Matière: 16 Ga Stainless Steel 316 (1.4mm)	
Color / Couleur: Unpainted	Finish / Fini: Brushed

Qty	Part Number	Rev	Description
1	STK-Q-16085	0	Ground Stud M6 x 16mm Stainless Steel
4	STK-Q-16020	1	Stud M8 x 35mm Stainless Steel
1	5412ESS2412086NOIPB-P	0	5412ESS 24" x 12" x 8" Body Part
Parts List			

Description: 5412ESS 24" x 12" x 8" Body		Detail Rev.	
Part Number / Numéro Pièce: 5412ESS2412086NOIPB	Rev. 0	7	7

This drawing is confidential and must not be reproduced or used without the consent of EXM

Ce dessin est confidentiel et ne doit pas être reproduit ou utilisé sans le consentement de EXM

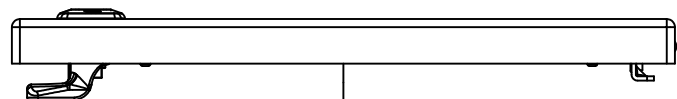

TOP

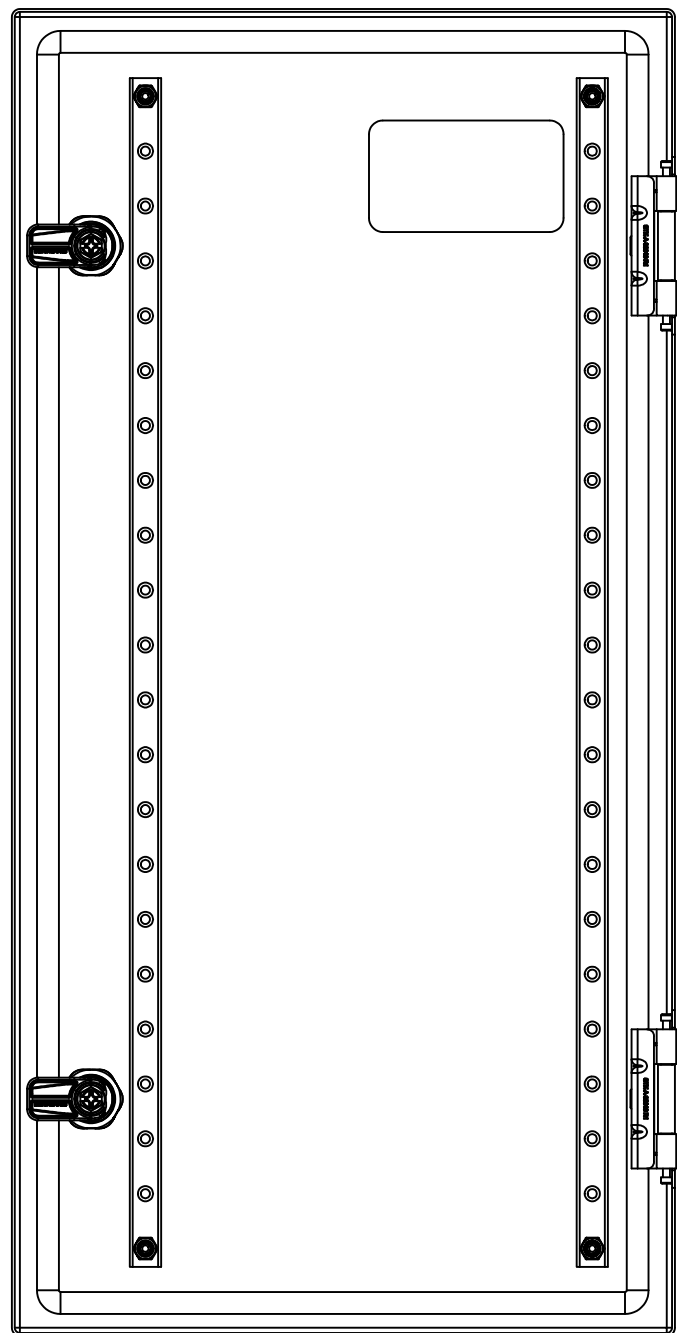

BACK

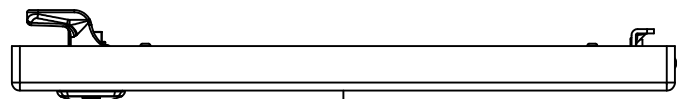

BOTTOM

0.000
0.800

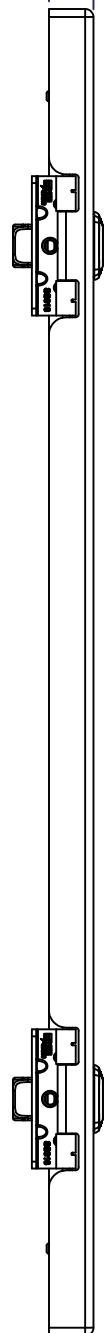

LEFT

0.000

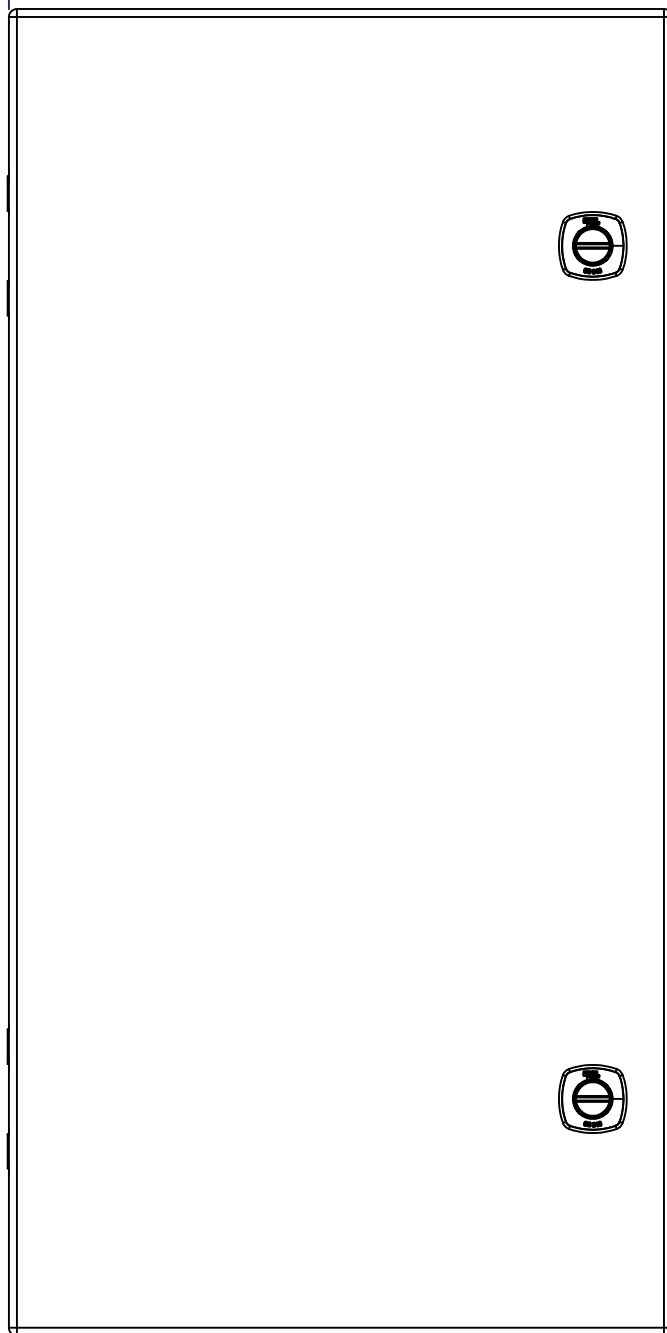

FRONT

11.918

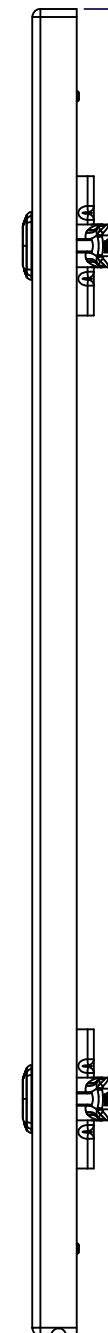

RIGHT

23.803

0.000

No.	Revisions	Date	By/Par

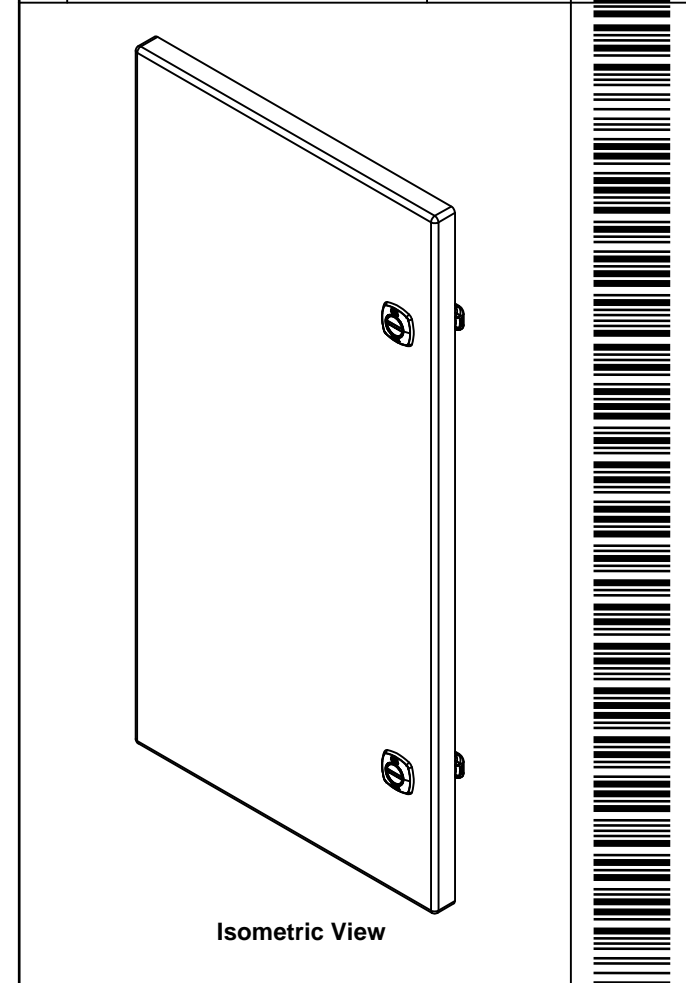

Isometric View

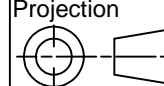

 Tél: (450) 979-4373 Fax: (450) 979-4626 www.exmweb.com		Flatness Aplatissement Max 3.0mm Projection 
Customer Client	Date	Date
Drawn By Dessiné Par	BoxCad: BoxCad	Date 03-May-22
Material Matière	16 Ga Stainless Steel 316 (1.4mm)	
Color Couleur	Unpainted	Finish Fini Brushed
Description	Detail Rev.	
5412ESS 24" x 12" Cover		
Part Number Numéro Pièce	Rev. 0	1 3

SEE BILL OF MATERIAL ON LAST PAGE

5412ESS2412086NOIPC

This drawing is confidential and must not be reproduced or used without the consent of EXM

Ce dessin est confidentiel et ne doit pas être reproduit ou utilisé sans le consentement de EXM

STANDARD FEATURES ARE NOT LISTED IN THIS HOLE TABLE

HOLE TABLE - FRONT VIEW (CUSTOM FEATURE ONLY)

CUT-OUT	XDIM	YDIM	DESCRIPTION
1	1.486	1.567	STUD M6 x 18mm (Inside)
2	1.486	22.236	STUD M6 x 18mm (Inside)
3	9.517	22.236	STUD M6 x 18mm (Inside)
4	9.517	1.567	STUD M6 x 18mm (Inside)

5	3.750	20.803	LABEL_EXM (Inside)
6	10.494	19.553	LOCK 880 SCQ4-SLSS6 @ 0.0°
7	10.494	4.250	LOCK 880 SCQ4-SLSS6 @ 0.0°

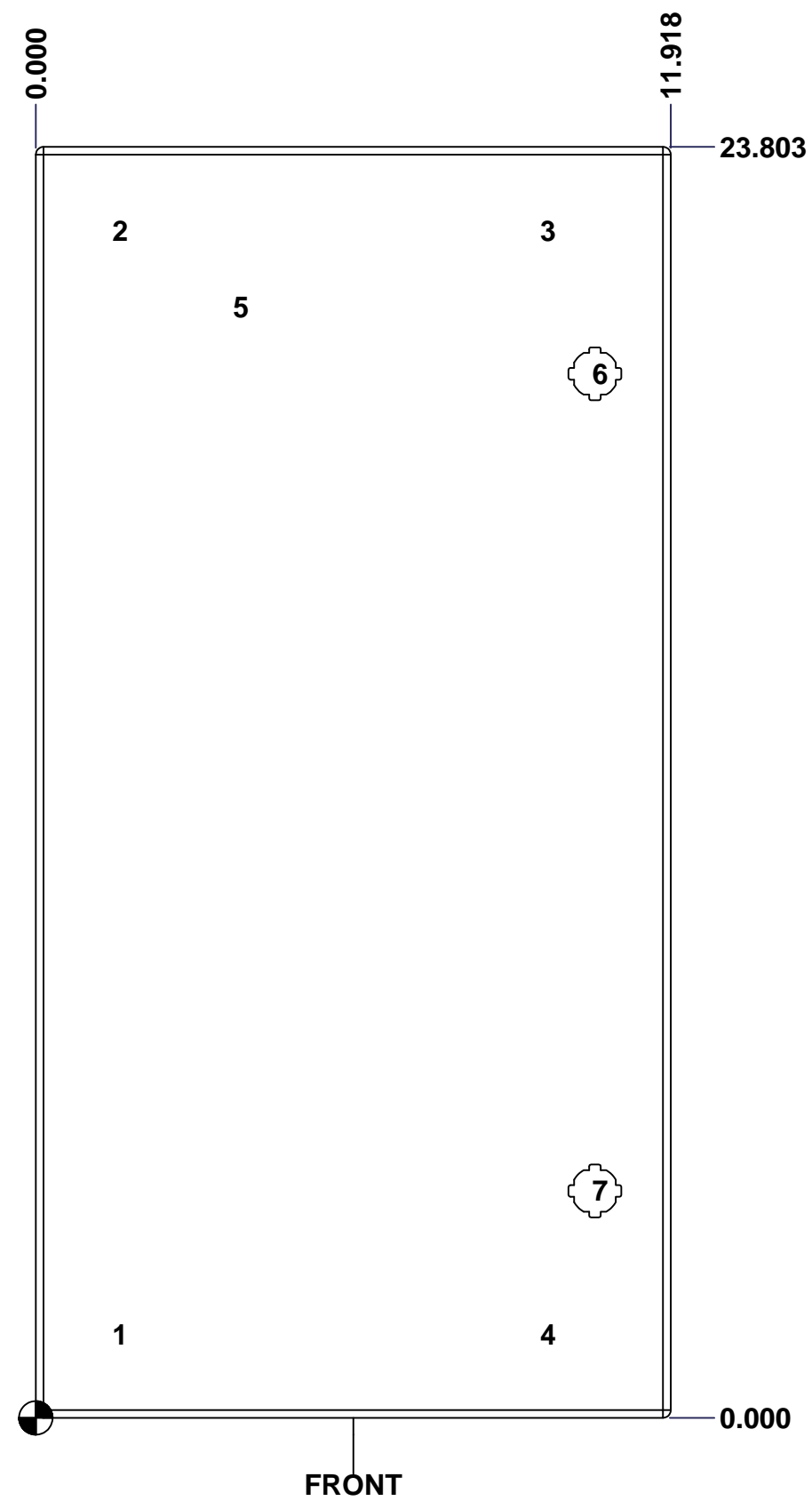

	Description	Status
	5412ESS 24" x 12" Cover	(NULL)
	Part Number Numéro Pièce	Rev.
	5412ESS2412086NOIPC	0 / 2 / 3

This drawing is confidential and must not be reproduced or used without the consent of EXM

Ce dessin est confidentiel et ne doit pas être reproduit ou utilisé sans le consentement de EXM

No.	Revisions	Date	By/Par

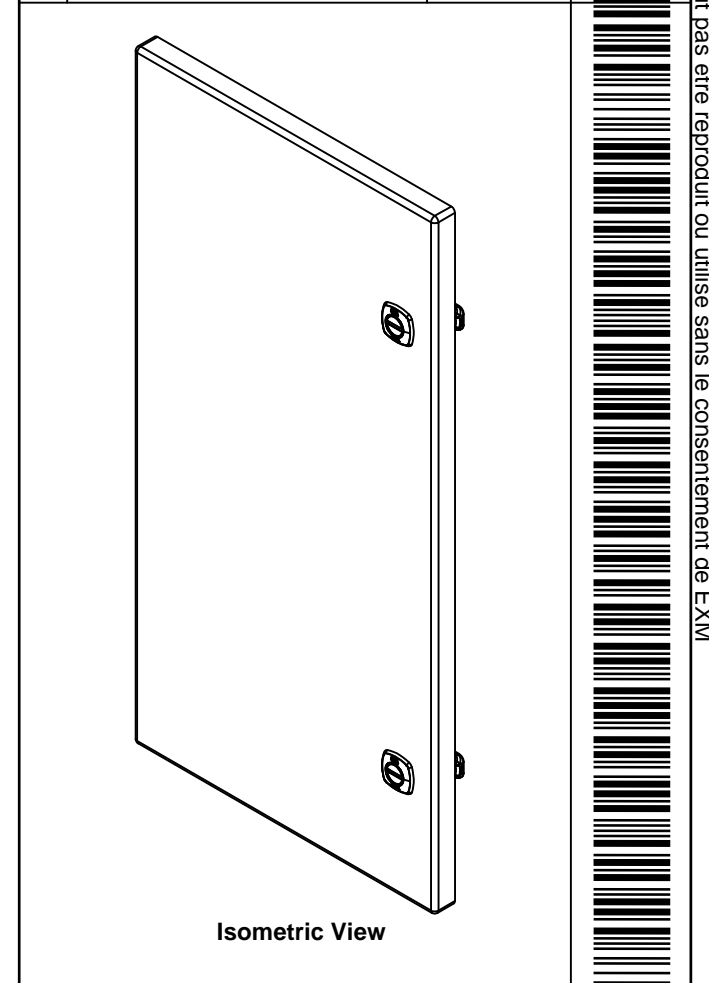

Isometric View

 Tél: (450) 979-4373
 Fax: (450) 979-4626
www.exmweb.com

Flatness / Aplatissement: Max 3.0mm
 Projection: 

Customer / Client	Date
Drawn By / Dessiné Par: BoxCad: BoxCad	Date: 03-May-22

Material / Matière	16 Ga Stainless Steel 316 (1.4mm)
--------------------	-----------------------------------

Color / Couleur: Unpainted	Finish / Fini: Brushed
----------------------------	------------------------

Description: 5412ESS 24" x 12" Cover	Detail Rev.
--------------------------------------	-------------

Part Number / Numéro Pièce: 5412ESS2412086NOIPC	Rev. / Rév.: 0	3
--	-----------------------	---

Qty	Part Name	Rev	Description
1	STK-S-00100	0	3.5" x 2" Silver Milar Flexcon Sticker
2	STK-Q-46020-24	5	5412 ES Vertical Door Stiffener 24"
4	STK-Q-16070	1	Stud M6 x 18mm Stainless steel
1	5412ESS2412086NOIPG	0	5412ESS 24" x 12" Cover Gasket Part
1	5412ESS2412086NOIPC-P	0	5412ESS 24" x 12" Cover Part
2	STK-A-33016	0	5412 ESS Bended Hinge (Body Part)
2	880 SCQ4-SLSS6	7	5412 ESS 1/4 Turn Lock
4	STK-Q-07220	1	M6 Nylon Insert Lock Nut
Parts List			