

This drawing is confidential and must not be reproduced or used without the consent of EXM

Ce dessin est confidentiel et ne doit pas être reproduit ou utilisé sans le consentement de EXM

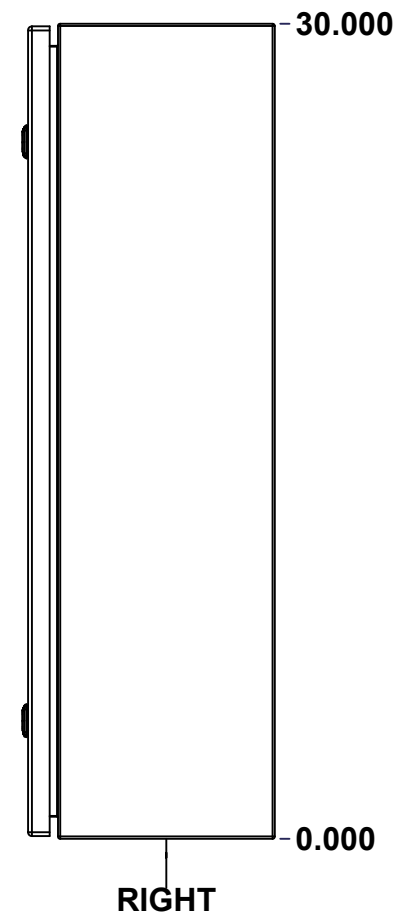

No.	Revisions	Date	By/Par

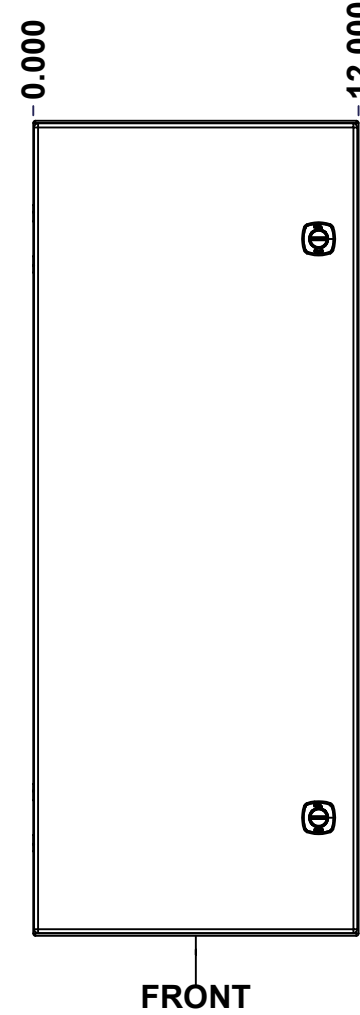
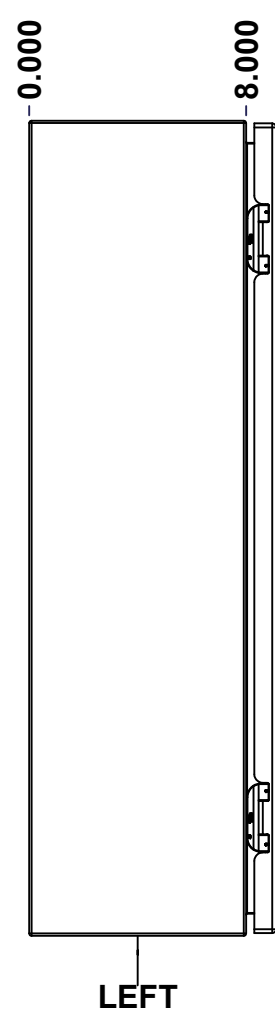
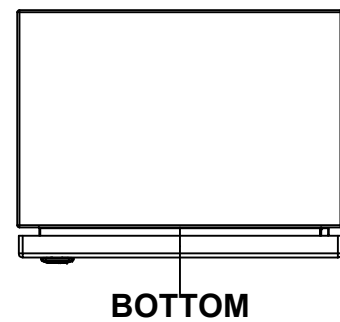
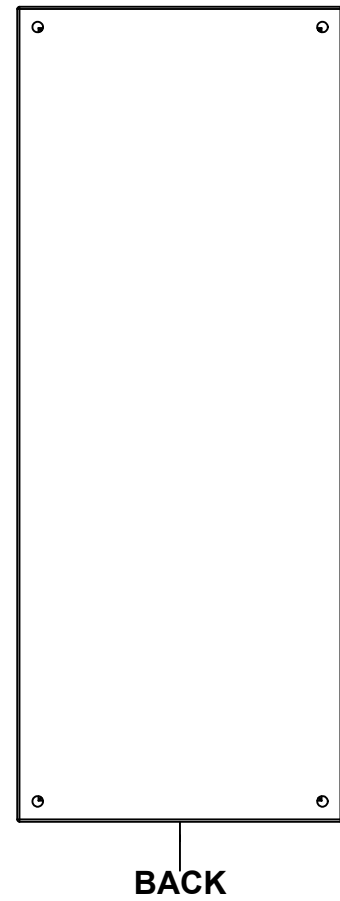
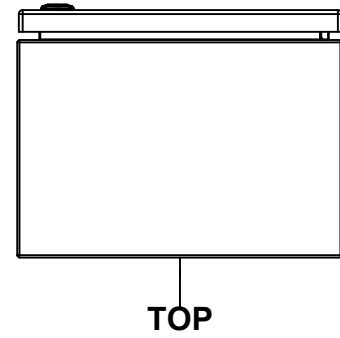
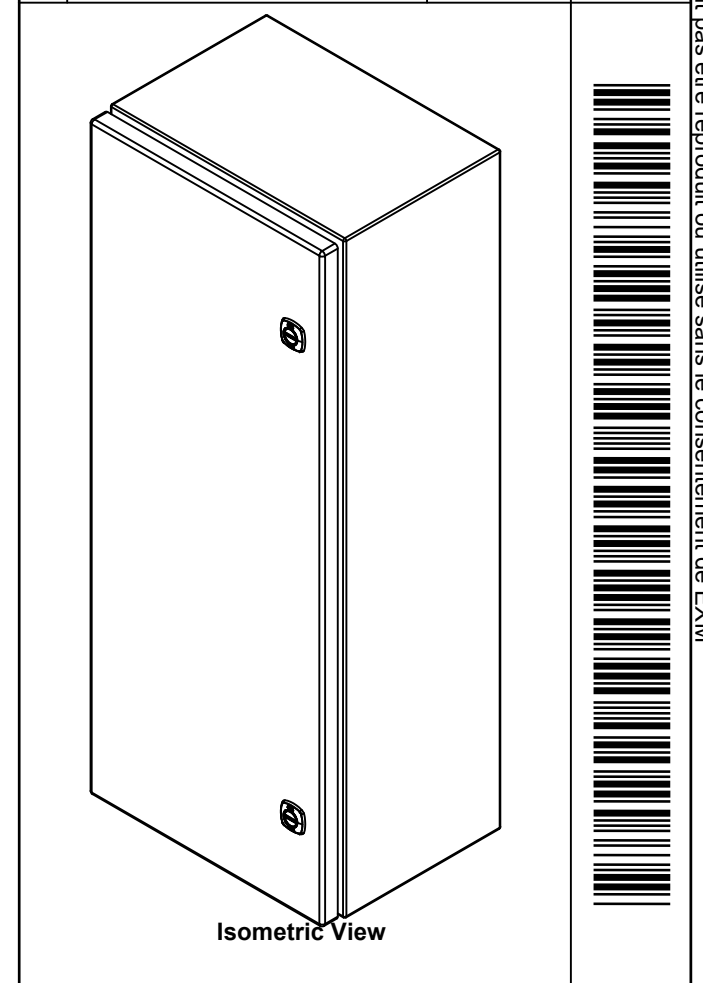

**GRAIN DIRECTION:
TOP/BOTTOM: HORIZONTAL
LEFT/RIGHT/BACK/FRONT: VERTICAL**

SEE BILL OF MATERIAL ON LAST PAGE

Tél: (450) 979-4373 Fax: (450) 979-4626 www.exmweb.com		Flatness Aplatissement Max 3.0mm Projection
Customer Client	Date	Date
Drawn By Dessiné Par	BoxCad: BoxCad	07-Feb-14
Material Matière	16 Ga Stainless Steel 304 (1.4mm)	
Color Couleur	Unpainted	Finish Fini: Brushed
Description	Detail Rev.	
5412ESS 30" x 12" x 8" Assembly		
Part Number Numéro Pièce	Rev.	1 2
5412ESS301208	0	

This drawing is confidential and must not be reproduced or used without the consent of EXM

Ce dessin est confidentiel et ne doit pas être reproduit ou utilisé sans le consentement de EXM

NOTE	
ITEM	DESCRIPTION
1	NEMA 4X Enclosure
2	C/W Standard ground studs on box and cover
3	C/W Standard door stiffener
4	C/W Standard inner panel (Included)
5	C/W Standard inner panel mounting studs

No.	Revisions	Date	By/Par

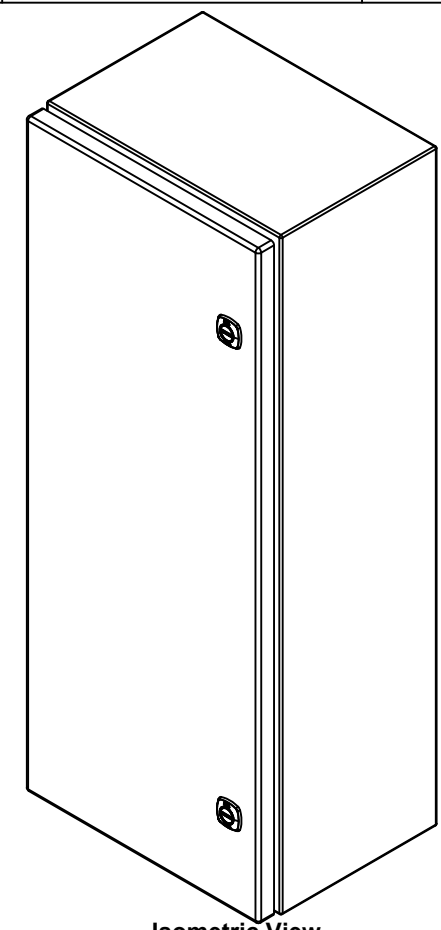

Isometric View

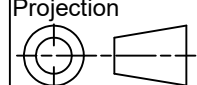
 Tél: (450) 979-4373 Fax: (450) 979-4626 www.exmweb.com		Flatness Aplatissement Max 3.0mm Projection 
Customer Client	Date	
Drawn By Dessiné Par	BoxCad: BoxCad	Date 07-Feb-14
Material Matière	16 Ga Stainless Steel 304 (1.4mm)	
Color Couleur	Unpainted	Finish Fini Brushed
Description		Detail Rev.
5412ESS 30" x 12" x 8" Assembly		
Part Number Numéro Pièce	Rev.	2
5412ESS301208	0	2

1	STK-K-01800	5	5412 ES Accessory Kit
1	881 SP3012G	0	881 SP - Inner Panel
1	5412ESS301208C	0	5412ESS 30" x 12" Cover
4	STK-Q-07310	2	Flange Lock Nut M8
4	STK-Q-07610	8	M8 Plastic Spacer 22.2mm
1	5412ESS301208B	0	5412ESS 30" x 12" x 8" Body
2	STK-Q-04051-07	8	M6 x 7mm Stainless Steel Hexagon Socket Head Machine Screw with Nyseal
Qty	Part Number	Rev	Description
Parts List			

PACKING		
ITEM	QTY	DESCRIPTION
Cardboard sleeve	2	Top and Bottom
Cardboard strip	2	Between back of enclosure and inner panel
Plastic bag	1	To protect cover surface and inside gasket
Plastic strap - Black	2	To Squeeze the 2 cardboard sleeve together
Packaging label	1	White label with product number

This drawing is confidential and must not be reproduced or used without the consent of EXM

Ce dessin est confidentiel et ne doit pas être reproduit ou utilisé sans le consentement de EXM



TOP

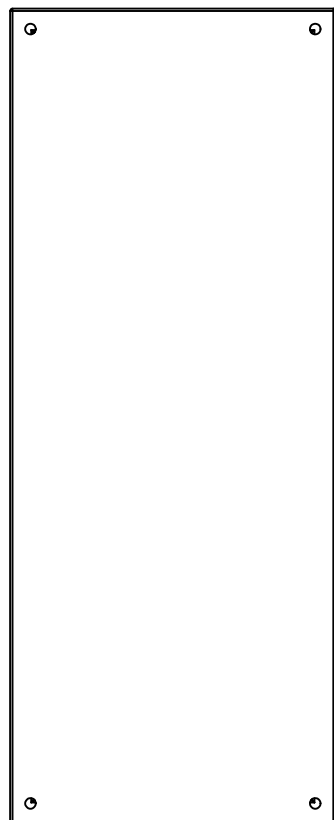

BACK

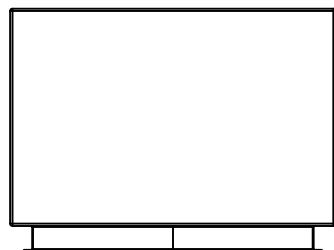

BOTTOM

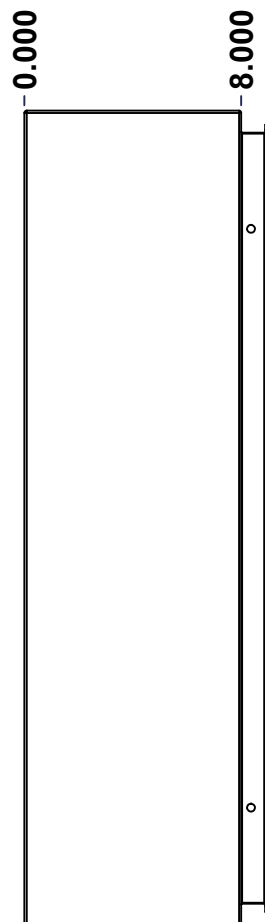

LEFT

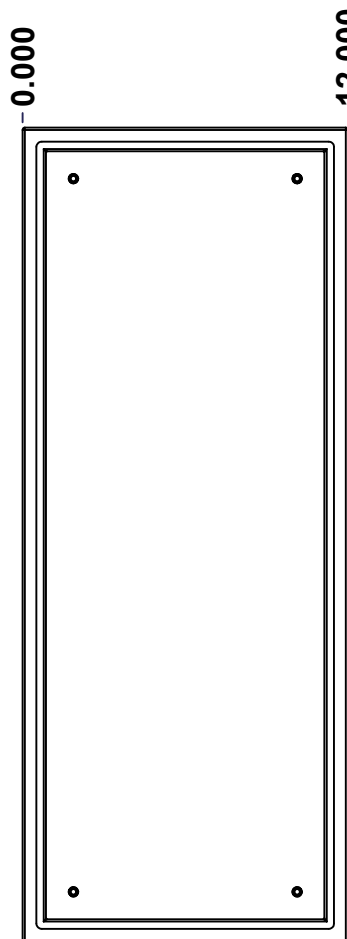

FRONT

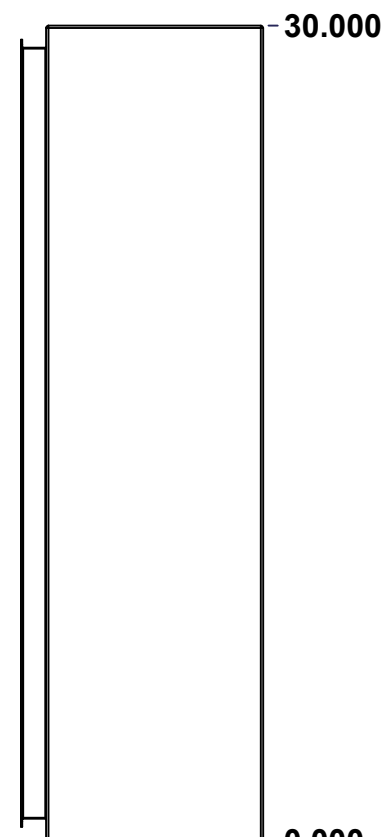

RIGHT

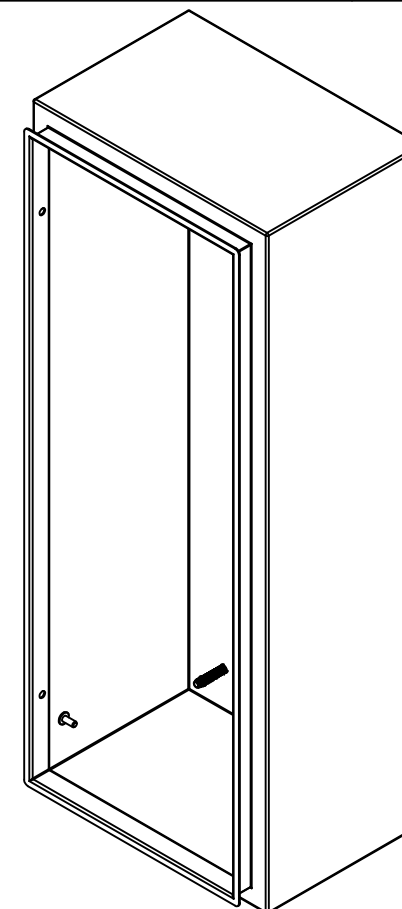

Isometric View

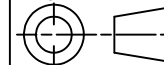

No.	Revisions	Date	By/Par

 Tél: (450) 979-4373 Fax: (450) 979-4626 www.exmweb.com		Flatness Aplatissement Max 3.0mm Projection 
Customer Client	Date	
Drawn By Dessiné Par	BoxCad: BoxCad	Date 07-Feb-14
Material Matière	16 Ga Stainless Steel 304 (1.4mm)	
Color Couleur	Unpainted	Finish Fini Brushed
Description	Detail Rev.	
5412ESS 30" x 12" x 8" Body		
Part Number Numéro Pièce	Rev.	1 7
5412ESS301208B	0	

SEE BILL OF MATERIAL ON LAST PAGE

This drawing is confidential and must not be reproduced or used without the consent of EXM

Ce dessin est confidentiel et ne doit pas être reproduit ou utilisé sans le consentement de EXM

STANDARD FEATURES ARE NOT LISTED IN THIS HOLE TABLE			
HOLE TABLE - LEFT VIEW (CUSTOM FEATURE ONLY)			
CUT-OUT	XDIM	YDIM	DESCRIPTION
1	6.500	2.000	GND STUD M6 x 16mm (Inside)

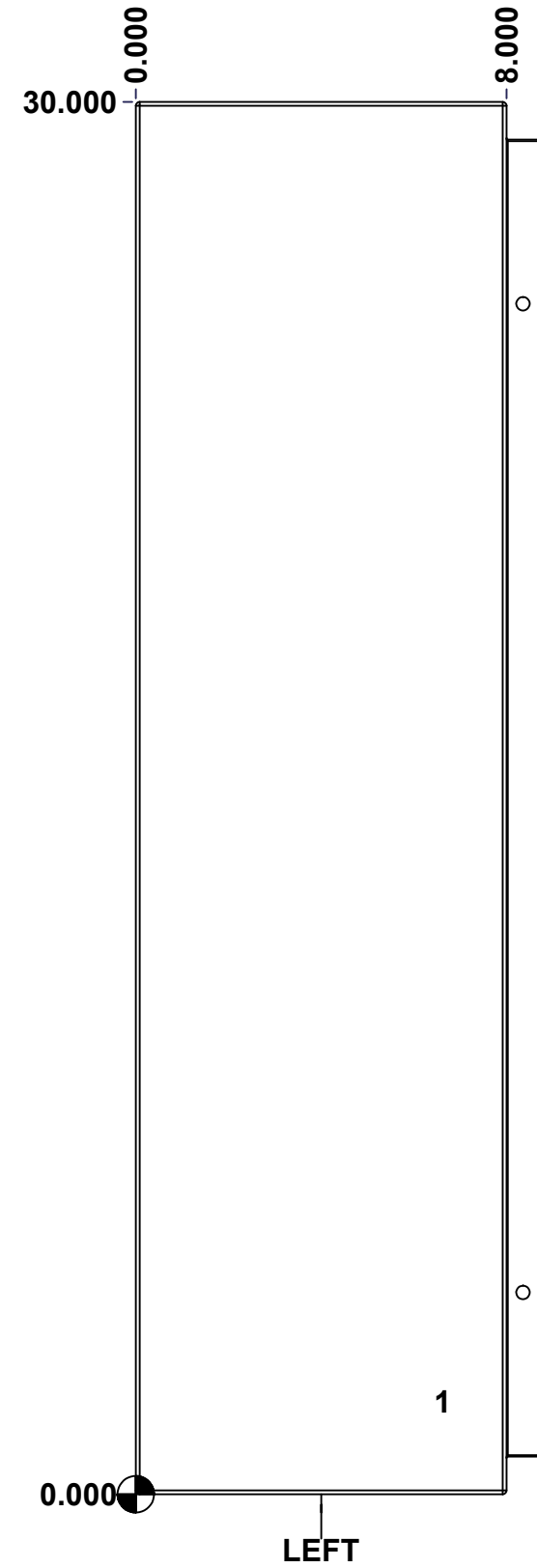

	Description	Status	
	5412ESS 30" x 12" x 8" Body		
	Part Number Numéro Pièce	Rev.	5 / 7
	5412ESS301208B	0	

This drawing is confidential and must not be reproduced or used without the consent of EXM

Ce dessin est confidentiel et ne doit pas être reproduit ou utilisé sans le consentement de EXM

STANDARD FEATURES ARE NOT LISTED IN THIS HOLE TABLE

HOLE TABLE - BACK VIEW (CUSTOM FEATURE ONLY)

CUT-OUT	XDIM	YDIM	DESCRIPTION
1	1.875	1.875	IP STUD M8 x 35mm (Inside)
2	1.875	28.125	IP STUD M8 x 35mm (Inside)
3	10.125	28.125	IP STUD M8 x 35mm (Inside)
4	10.125	1.875	IP STUD M8 x 35mm (Inside)

5	11.250	0.750	RND Ø0.390
6	11.250	29.250	RND Ø0.390
7	0.750	29.250	RND Ø0.390
8	0.750	0.750	RND Ø0.390

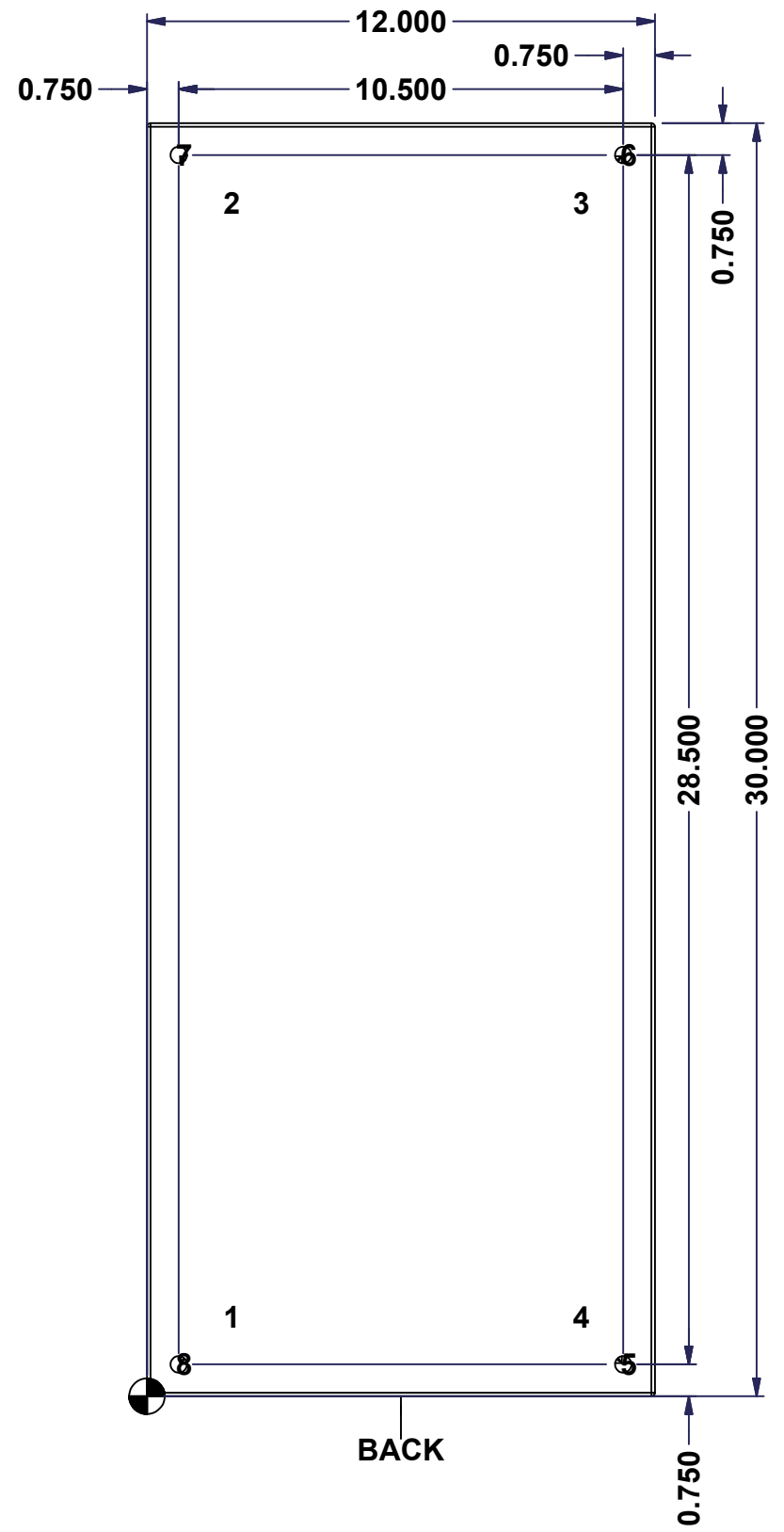

	Description	Status	
	5412ESS 30" x 12" x 8" Body		
	Part Number Numéro Pièce	Rev.	
	5412ESS301208B	0	6 7

This drawing is confidential and must not be reproduced or used without the consent of EXM

Ce dessin est confidentiel et ne doit pas être reproduit ou utilisé sans le consentement de EXM

No.	Revisions	Date	By/Par

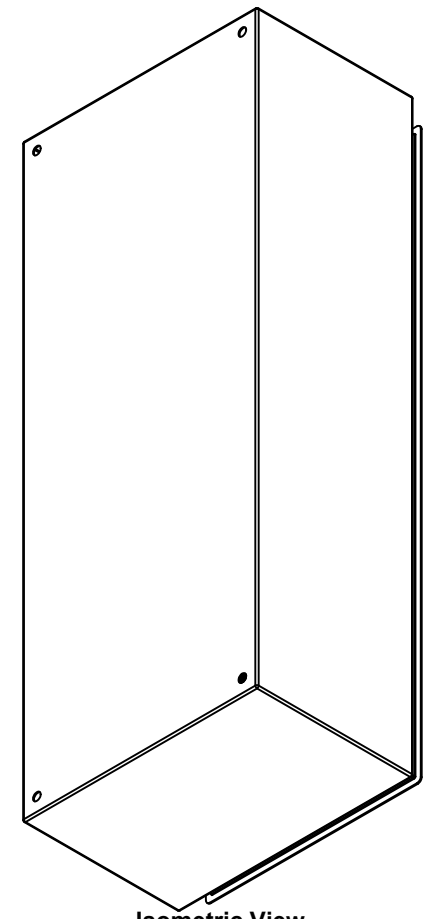

Isometric View

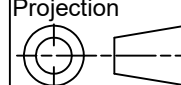

 Tél: (450) 979-4373 Fax: (450) 979-4626 www.exmweb.com		Flatness Aplatissement Max 3.0mm Projection 
Customer Client	Date	
Drawn By Dessiné Par	BoxCad: BoxCad	Date 07-Feb-14
Material Matière	16 Ga Stainless Steel 304 (1.4mm)	
Color Couleur	Unpainted	Finish Fini Brushed
Description	Detail Rev.	
5412ESS 30" x 12" x 8" Body		
Part Number Numéro Pièce	Rev.	7
5412ESS301208B	0	7

Qty	Part Number	Rev	Description
1	STK-Q-16085	0	Ground Stud M6 x 16mm Stainless Steel
4	STK-Q-16020	1	Stud M8 x 35mm Stainless Steel
1	5412ESS301208B-P	0	5412ESS 30" x 12" x 8" Body Part
Parts List			

This drawing is confidential and must not be reproduced or used without the consent of EXM

Ce dessin est confidentiel et ne doit pas être reproduit ou utilisé sans le consentement de EXM

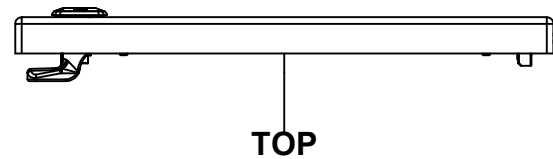

TOP

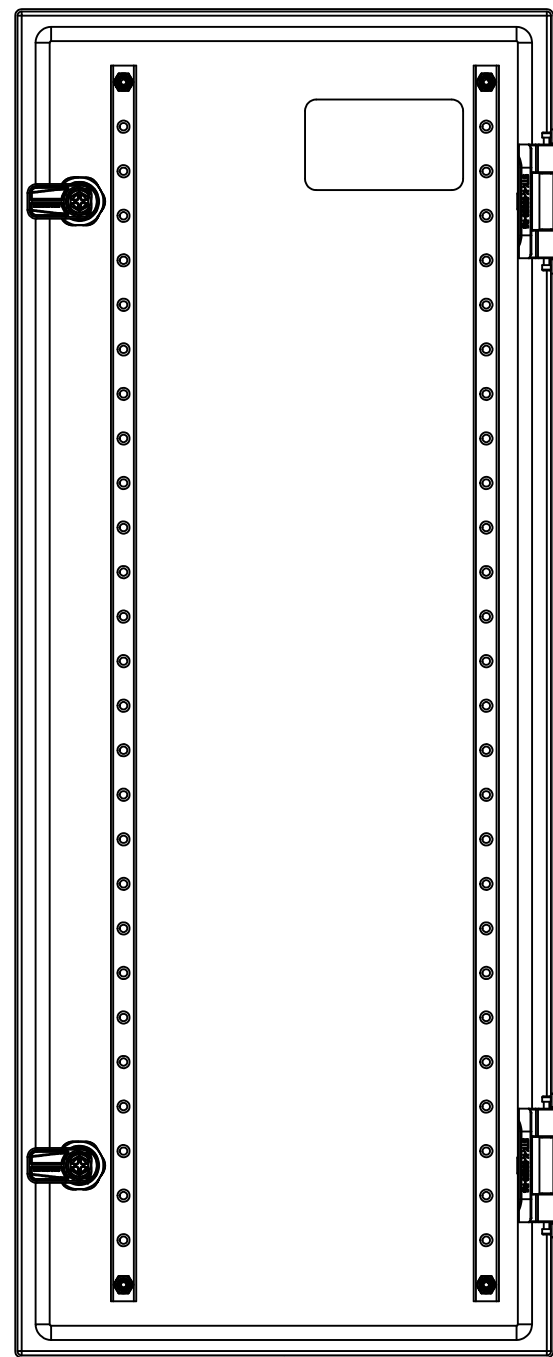

BACK

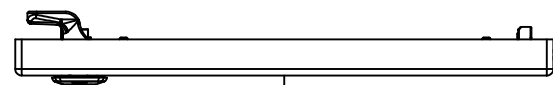

BOTTOM

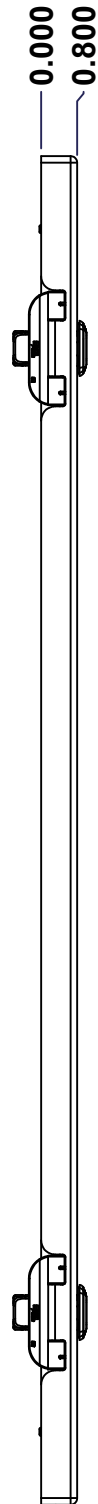

LEFT

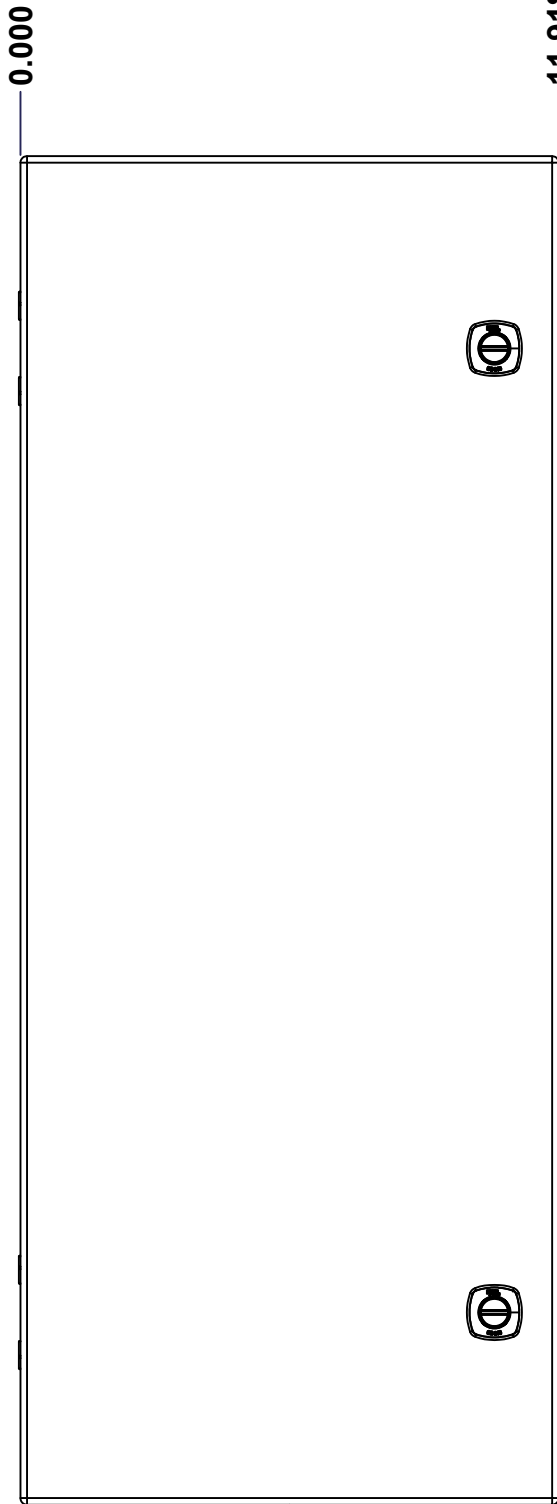

FRONT

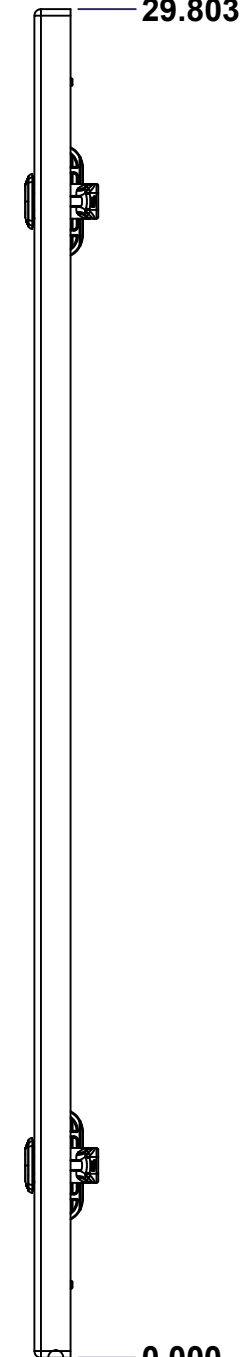

RIGHT

0.000
0.800

0.000

11.918

29.803

0.000

No.	Revisions	Date	By/Par

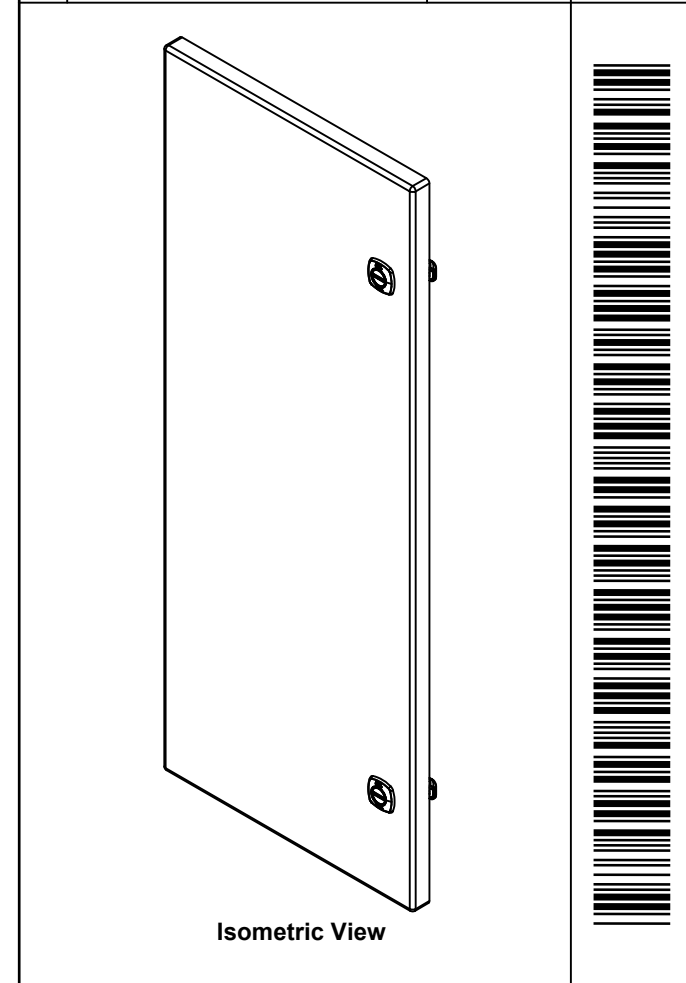

 Tél: (450) 979-4373 Fax: (450) 979-4626 www.exmweb.com		Flatness Aplatissement	
		Max 3.0mm	
Customer Client		Date	
Drawn By Dessiné Par BoxCad: BoxCad		Date 07-Feb-14	
Material Matière 16 Ga Stainless Steel 304 (1.4mm)		Projection	
Color Couleur Unpainted		Finish Fini Brushed	
Description 5412ESS 30" x 12" Cover		Detail Rev.	
Part Number Numéro Pièce 5412ESS301208C		Rev. 0	1 3

SEE BILL OF MATERIAL ON LAST PAGE

This drawing is confidential and must not be reproduced or used without the consent of EXM

Ce dessin est confidentiel et ne doit pas être reproduit ou utilisé sans le consentement de EXM

STANDARD FEATURES ARE NOT LISTED IN THIS HOLE TABLE

HOLE TABLE - FRONT VIEW (CUSTOM FEATURE ONLY)

CUT-OUT	XDIM	YDIM	DESCRIPTION
1	1.486	1.614	STUD M6 x 18mm (Inside)
2	1.486	28.189	STUD M6 x 18mm (Inside)
3	9.517	28.189	STUD M6 x 18mm (Inside)
4	9.517	1.614	STUD M6 x 18mm (Inside)

5	3.750	26.803	LABEL_EXM (Inside)
6	10.494	25.553	LOCK 880 SCQ4-SLSS6 @ 0.0°
7	10.494	4.250	LOCK 880 SCQ4-SLSS6 @ 0.0°

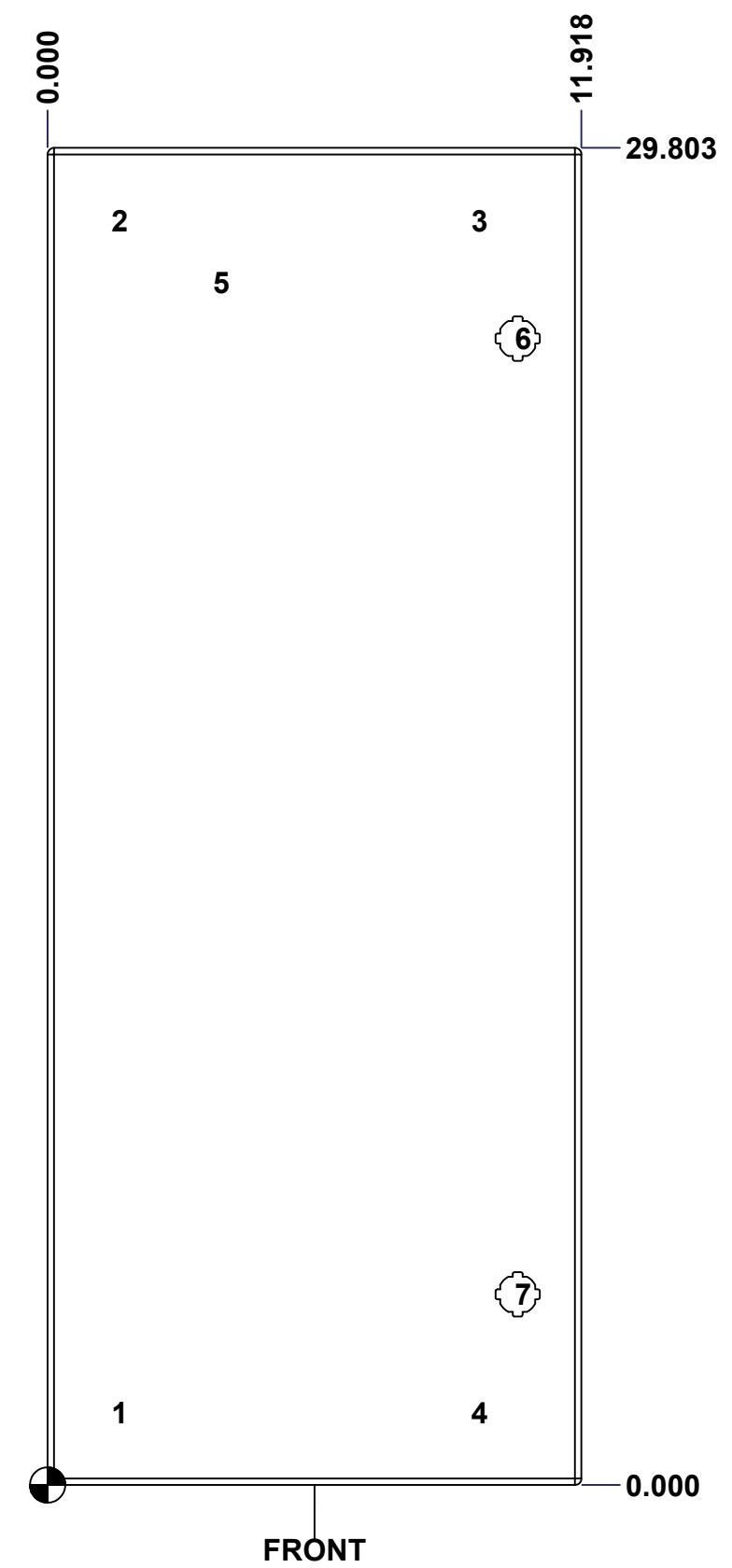



	Description	Status
	5412ESS 30" x 12" Cover	(NULL)
	Part Number Numéro Pièce	Rev.
	5412ESS301208C	0
		2
		3

This drawing is confidential and must not be reproduced or used without the consent of EXM

Ce dessin est confidentiel et ne doit pas être reproduit ou utilisé sans le consentement de EXM

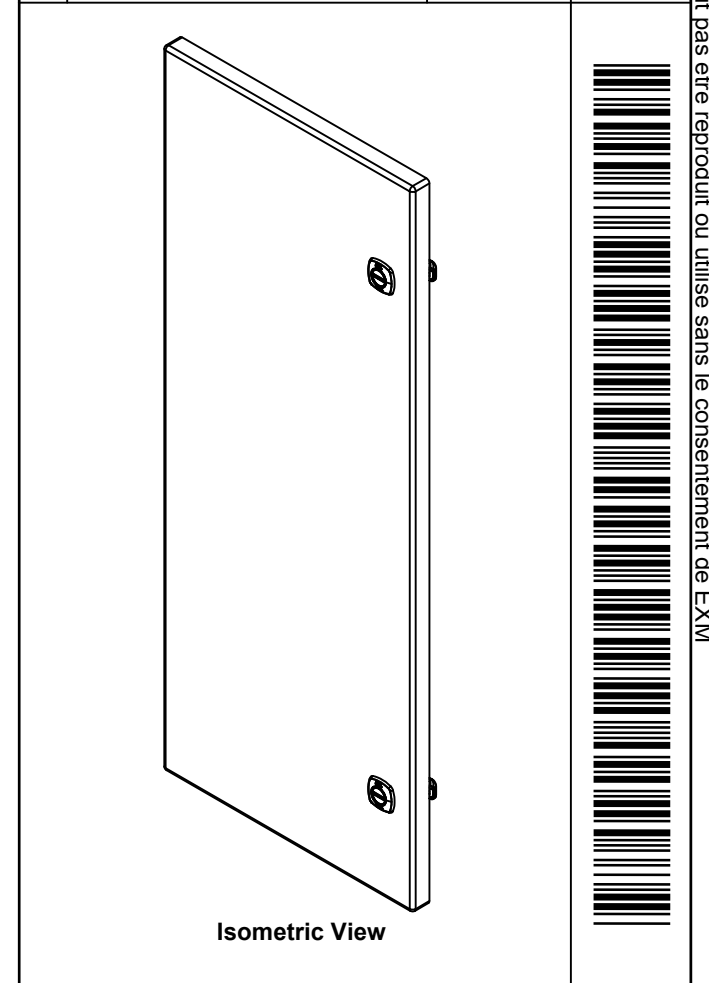
No.	Revisions	Date	By/Par

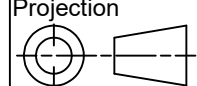

 Tél: (450) 979-4373 Fax: (450) 979-4626 www.exmweb.com		Flatness Aplatissement Max 3.0mm Projection 
Customer Client	Date	Date
Drawn By Dessiné Par	BoxCad: BoxCad	07-Feb-14
Material Matière	16 Ga Stainless Steel 304 (1.4mm)	
Color Couleur	Unpainted	Finish Fini Brushed
Description	Detail Rev.	
5412ESS 30" x 12" Cover		
Part Number Numéro Pièce	Rev.	3
5412ESS301208C	0	3

Qty	Part Name	Rev	Description
1	STK-S-00100	0	3.5" x 2" Silver Milar Flexcon Sticker
2	STK-Q-46020-30	5	5412 ES Vertical Door Stiffener 30"
4	STK-Q-16070	1	Stud M6 x 18mm Stainless steel
1	5412ESS301208G	0	5412ESS 30" x 12" Cover Gasket Part
1	5412ESS301208C-P	0	5412ESS 30" x 12" Cover Part
2	STK-K-09850	6	5412 ESS Hinge with 2 Captive Hinge Pins
2	880 SCQ4-SLSS6	7	5412 ESS 1/4 Turn Lock
4	STK-Q-07220	1	M6 Nylon Insert Lock Nut
Parts List			

This drawing is confidential and must not be reproduced or used without the consent of EXM

Ce dessin est confidentiel et ne doit pas être reproduit ou utilisé sans le consentement de EXM

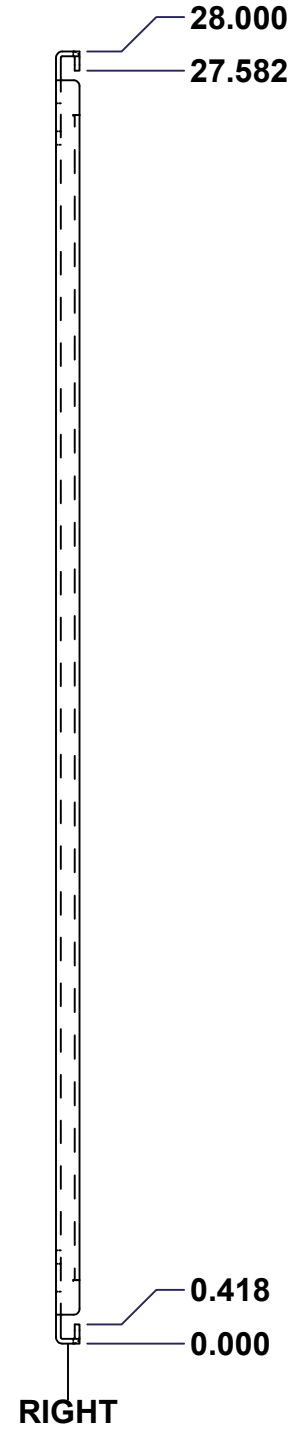
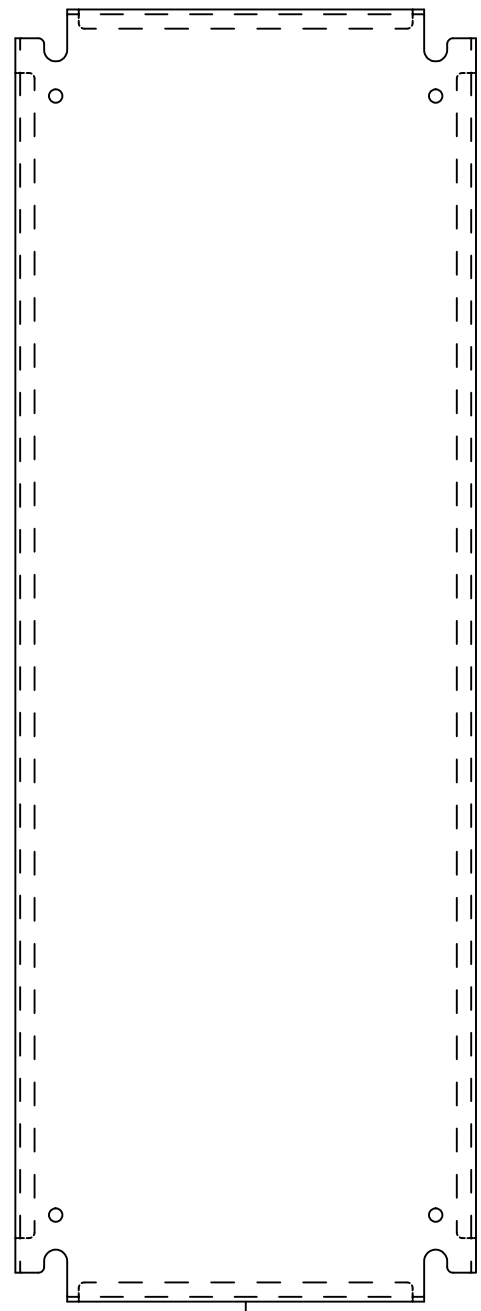
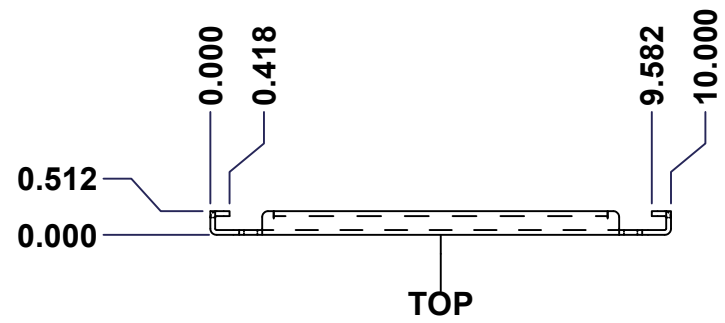

No.	Revisions	Date	By/Par

Isometric View

Tél: (450) 979-4373 Fax: (450) 979-4626 www.exmweb.com		Flatness Aplatissement Max 3.0mm Projection
Customer Client	Date	
Drawn By Dessiné Par	BoxCad	Date 1/23/2007
Material Matière	See Part List	
Color Couleur	See Part List	Finish Fini See Part List
Description		Detail Rev.
881 SP - Inner Panel		
Part Number Numéro Pièce	881 SP3012G	Rev. 1 0

Qty	Part Number	Rev	Description	Material	Color	Finish
1	881 SP3012G-P	0	881 SP - Inner Panel Part	12 Ga Galvanized	Unpainted	Galvanized

Parts List

This drawing is confidential and must not be reproduced or used without the consent of EXM

Ce dessin est confidentiel et ne doit pas être reproduit ou utilisé sans le consentement de EXM

Table 1			FRONT VIEW
CUT-OUT	XDIM	YDIM	DESCRIPTION
1	0.875	1.875	GROUND HOLE (RND Ø0.290)
2	9.125	1.875	GROUND HOLE (RND Ø0.290)
3	0.875	26.125	GROUND HOLE (RND Ø0.290)
4	9.125	26.125	GROUND HOLE (RND Ø0.290)

All knockouts are actual size / Les disques défonçables sont grandeur réel

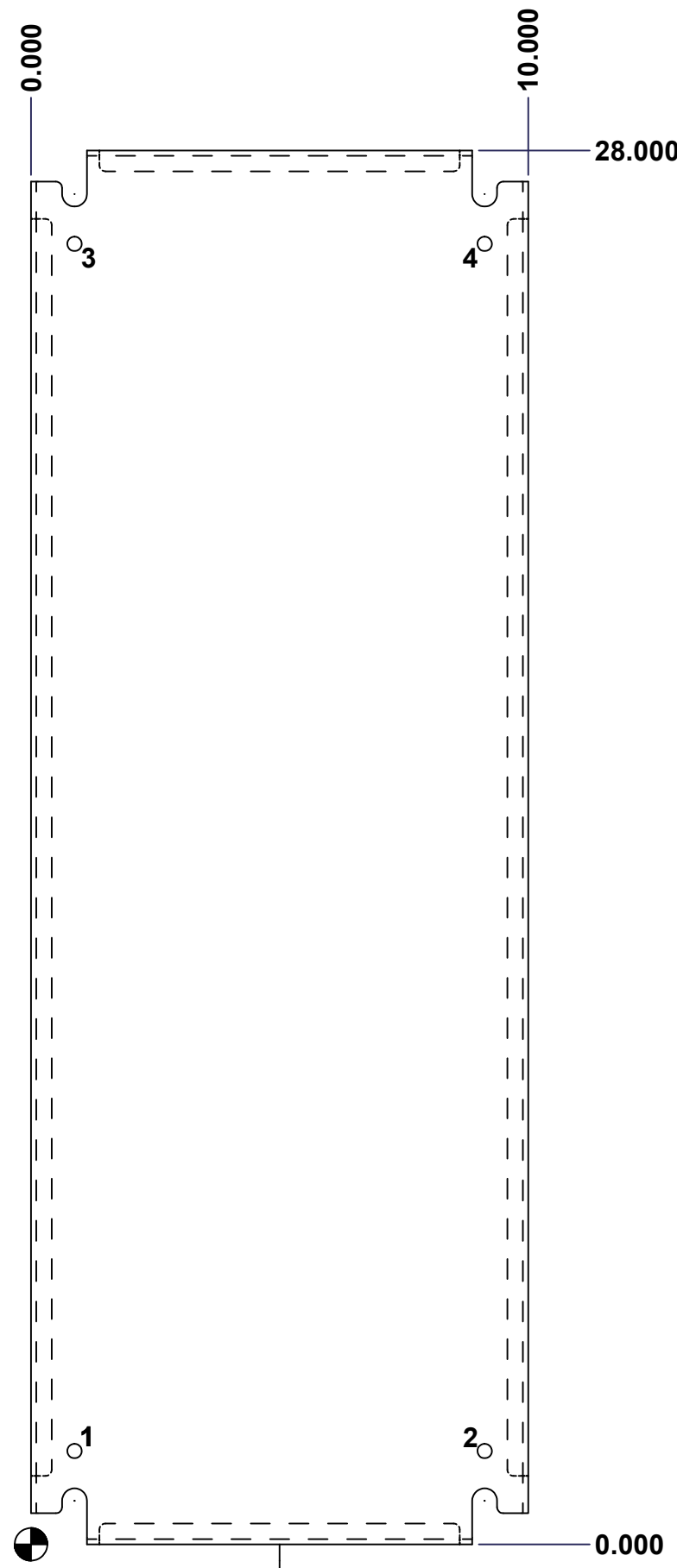

FRONT

No.	Revisions	Date	By/Par

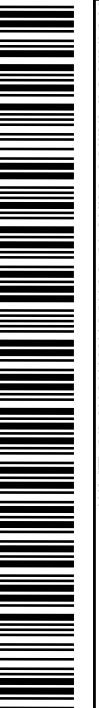
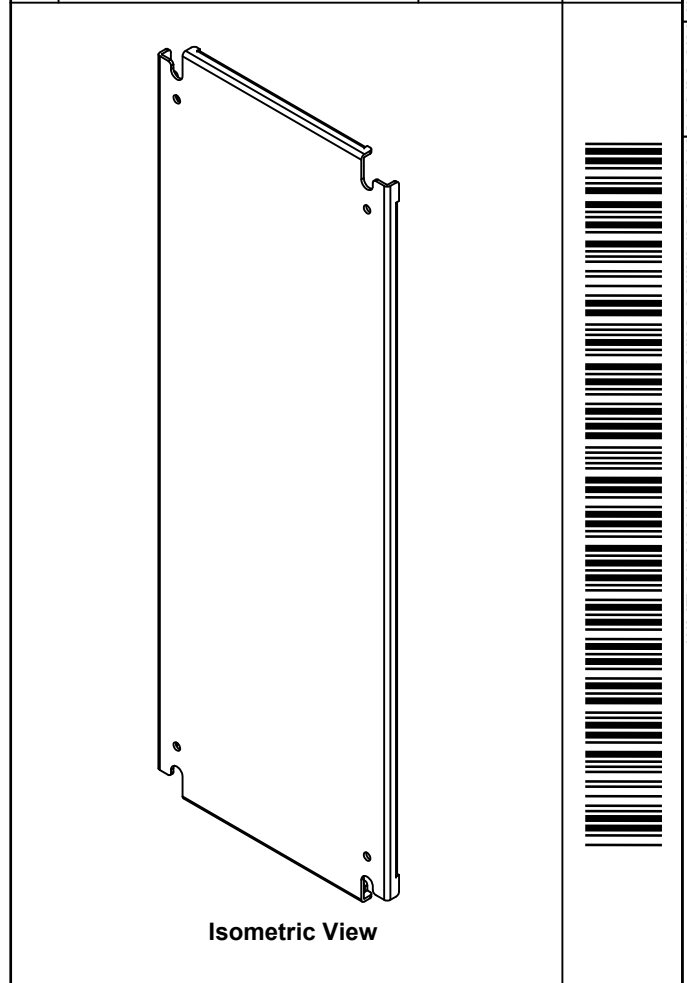

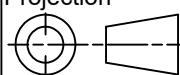
 Tél: (450) 979-4373 Fax: (450) 979-4626 www.exmweb.com		Flatness Aplatissement Max 3.0mm
Projection 		Date
Customer Client	Drawn By Dessiné Par BoxCad	Date 1/23/2007
Material Matière	See Part List	
Color Couleur	See Part List	Finish Fini See Part List
Description 881 SP - Inner Panel		Detail Rev.
Part Number Numéro Pièce	881 SP3012G	Rev. 2 0