

This drawing is confidential and must not be reproduced or used without the consent of EXM

Ce dessin est confidentiel et ne doit pas être reproduit ou utilisé sans le consentement de EXM

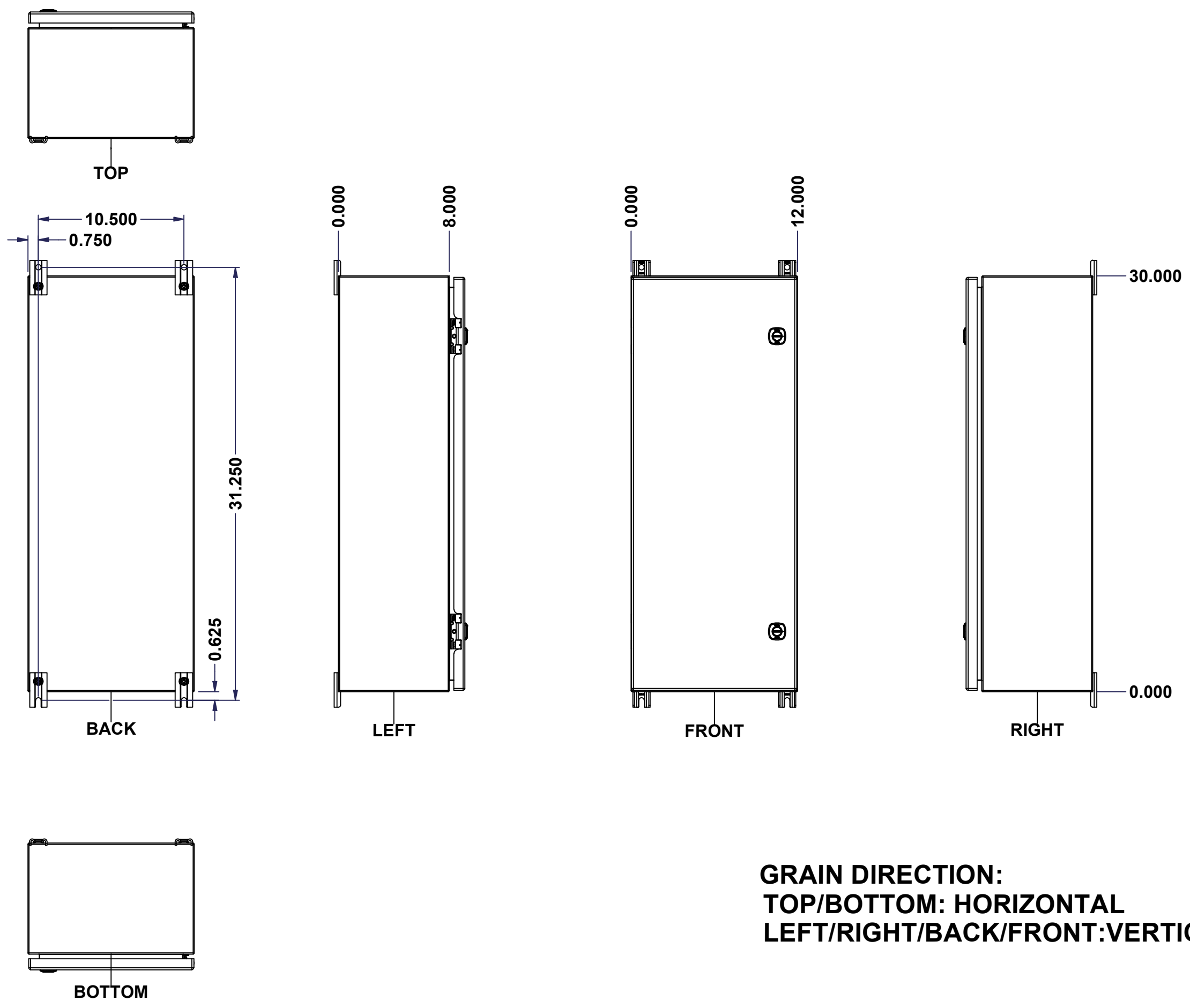

**GRAIN DIRECTION:
TOP/BOTTOM: HORIZONTAL
LEFT/RIGHT/BACK/FRONT: VERTICAL**

| No. | Revisions | Date | By/Par |
|-----|-----------|------|--------|
| | | | |
| | | | |
| | | | |
| | | | |

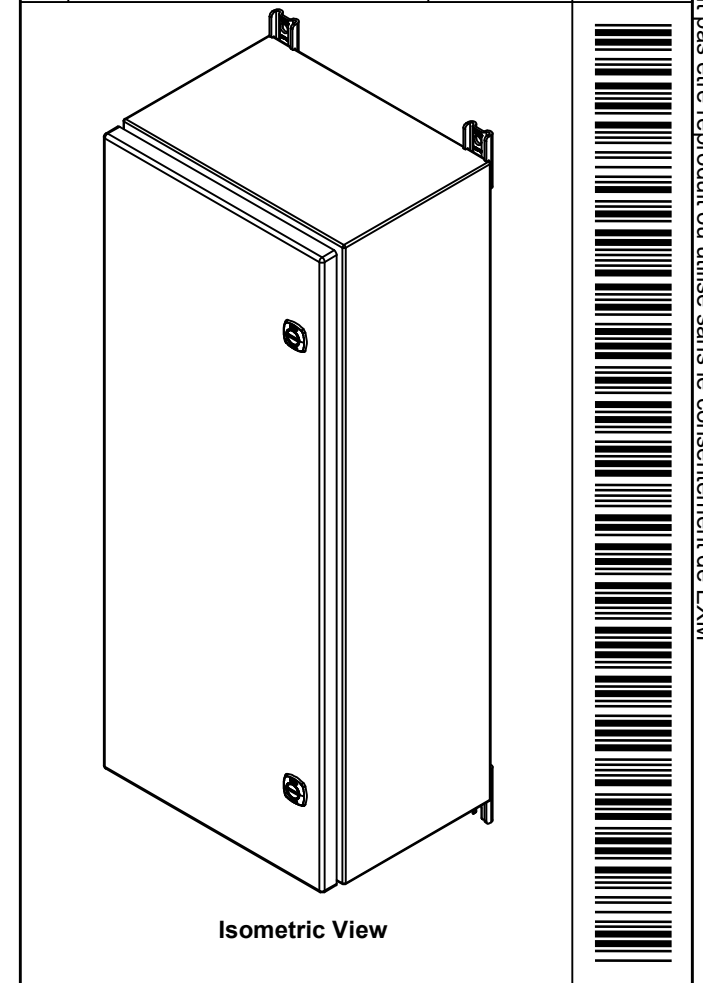

| | | |
|--|----------------------|--|
| Tél: (450) 979-4373 Fax: (450) 979-4626 www.exmweb.com | | Flatness Aplatissement Max 3.0mm Projection |
| Customer Client | Date | |
| Drawn By Dessiné Par: BoxCad: BoxCad | Date: 30-May-23 | |
| Material Matière: 16 Ga Stainless Steel 316 (1.4mm) | | |
| Color Couleur: Unpainted | Finish Fini: Brushed | |
| Description: 5412ESS 30" x 12" x 8" Assembly | Detail Rev. | |
| Part Number Numéro Pièce: 5412ESS3012086TH | Rev. 0 | 1 / 16 |

SEE BILL OF MATERIAL ON LAST PAGE

This drawing is confidential and must not be reproduced or used without the consent of EXM

Ce dessin est confidentiel et ne doit pas être reproduit ou utilisé sans le consentement de EXM

| NOTE | |
|------|---|
| ITEM | DESCRIPTION |
| 1 | NEMA 4X Enclosure |
| 2 | C/W Standard ground studs on box and cover |
| 3 | C/W Standard door stiffener |
| 4 | C/W Standard inner panel (Included) |
| 5 | C/W Standard inner panel mounting studs |
| 6 | C/W 885 ESMF4_OPEN Sold separately (Installed) |
| 7 | C/W 885 ESMF4_CLOSE Sold separately (Installed) |
| 8 | C/W R5 Insulation (Installed by EXM) |

| No. | Revisions | Date | By/Par |
|-----|-----------|------|--------|
| | | | |
| | | | |
| | | | |
| | | | |
| | | | |
| | | | |
| | | | |

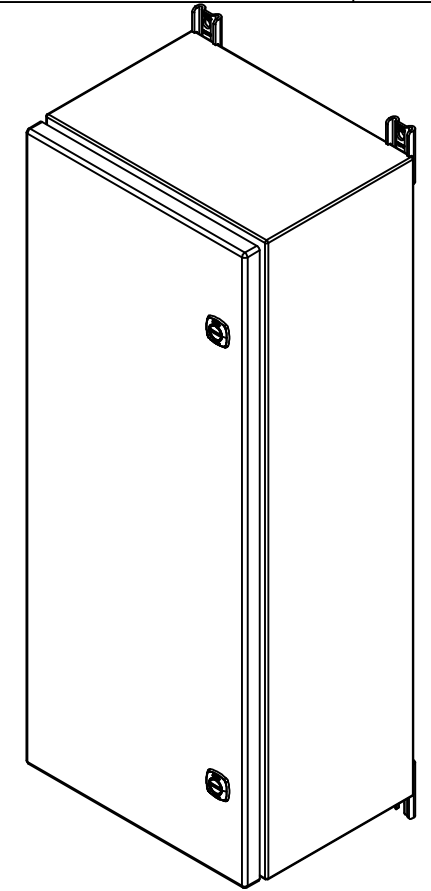

Isometric View

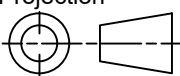

| | | |
|--|-----------------------------------|---|
|  Tél: (450) 979-4373 Fax: (450) 979-4626 www.exmweb.com | Flatness Aplatissement | Max 3.0mm |
| | Projection |  |
| Customer Client | Date | |
| Drawn By Dessiné Par | BoxCad: BoxCad | Date 30-May-23 |
| Material Matière | 16 Ga Stainless Steel 316 (1.4mm) | |
| Color Couleur | Unpainted | Finish Fini Brushed |
| Description | Detail Rev. | |
| 5412ESS 30" x 12" x 8" Assembly | | |
| Part Number Numéro Pièce | Rev. | 2 |
| 5412ESS3012086TH | 0 | 16 |

| PACKING | | |
|-----------------------|-----|--|
| ITEM | QTY | DESCRIPTION |
| Cardboard sleeve | 2 | Top and Bottom |
| Cardboard strip | 2 | Between back of enclosure and inner panel |
| Plastic bag | 1 | To protect cover surface and inside gasket |
| Plastic strap - Black | 2 | To Squeeze the 2 cardboard sleeve together |
| Packaging label | 1 | White label with product number |

| | | | |
|------------|-------------------|-----|--|
| 4 | STK-Q-00600 | 2 | M12 to M8 Adaptor |
| 1 | 881 SP3012G | 0 | 881 SP - Inner Panel |
| 1 | STK-K-01800 | 5 | 5412 ES Accessory Kit |
| 1 | 5412ESS3012086THC | 0 | 5412ESS 30" x 12" Cover |
| 1 | 5412ESS3012086THB | 0 | 5412ESS 30" x 12" x 8" Body |
| 2 | STK-Q-04051-08 | 1 | M6 x 8mm Stainless Steel Hexagon Socket Head Machine Screw with Nyseal |
| Qty | Part Number | Rev | Description |
| Parts List | | | |

This drawing is confidential and must not be reproduced or used without the consent of EXM

Ce dessin est confidentiel et ne doit pas être reproduit ou utilisé sans le consentement de EXM

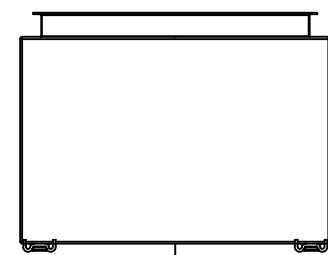

TOP

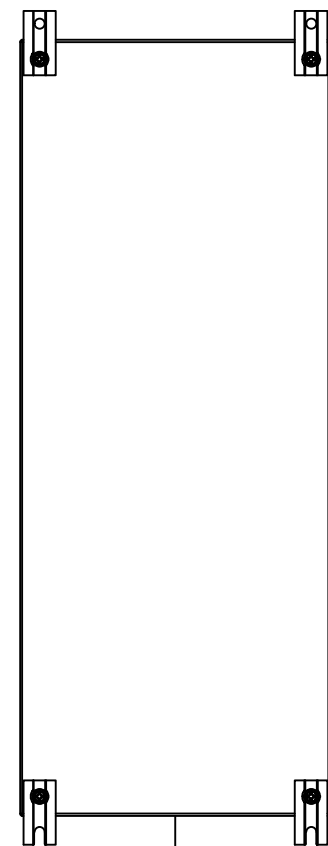

BACK

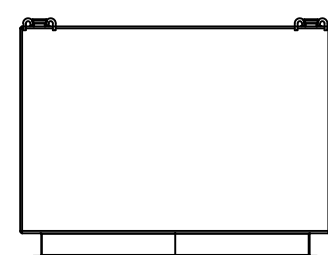

BOTTOM

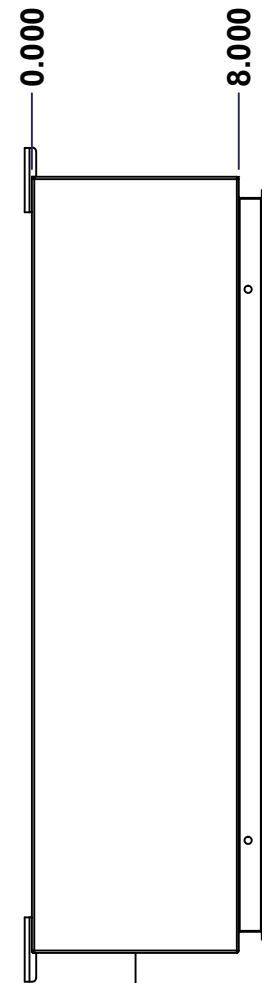

LEFT

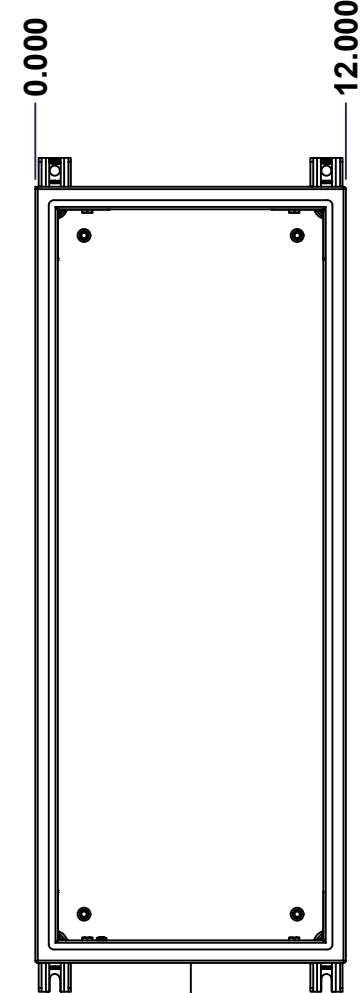

FRONT

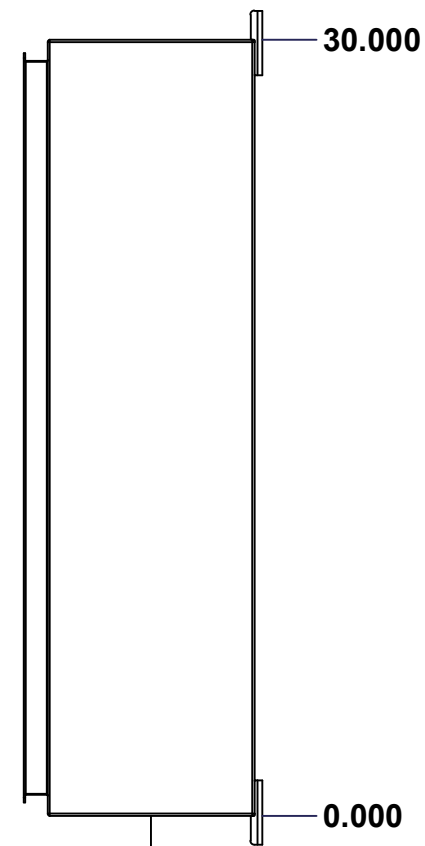

RIGHT

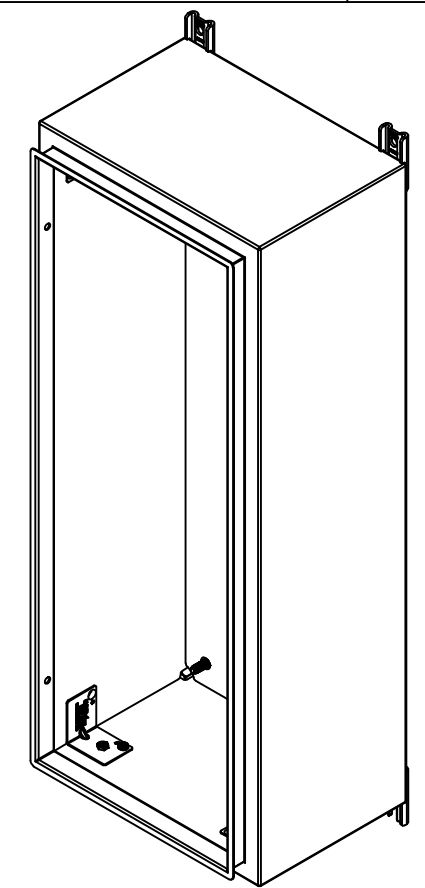

Isometric View

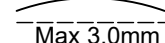
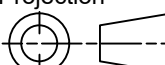

| No. | Revisions | Date | By/Par |
|-----|-----------|------|--------|
| | | | |
| | | | |
| | | | |
| | | | |

| | | |
|--|-----------------------------------|--|
|  Tél: (450) 979-4373 Fax: (450) 979-4626 www.exmweb.com | | Flatness Aplatissement  Max 3.0mm Projection  |
| Customer Client | Date | |
| Drawn By Dessiné Par | BoxCad: BoxCad | Date 30-May-23 |
| Material Matière | 16 Ga Stainless Steel 316 (1.4mm) | |
| Color Couleur | Unpainted | Finish Fini Brushed |
| Description | Detail Rev. | |
| 5412ESS 30" x 12" x 8" Body | | |
| Part Number Numéro Pièce | Rev. | 3 |
| SEE BILL OF MATERIAL ON LAST PAGE | 5412ESS3012086THB | 0 |

SEE BILL OF MATERIAL ON LAST PAGE

5412ESS3012086THB

Rev. 0 / 3 / 16

This drawing is confidential and must not be reproduced or used without the consent of EXM

Ce dessin est confidentiel et ne doit pas être reproduit ou utilisé sans le consentement de EXM

| STANDARD FEATURES ARE NOT LISTED IN THIS HOLE TABLE | | | |
|---|--------|-------|--------------------------------|
| HOLE TABLE - TOP VIEW (CUSTOM FEATURE ONLY) | | | |
| CUT-OUT | XDIM | YDIM | DESCRIPTION |
| 1 | 2.000 | 6.500 | INSUL. STUD M6 x 18mm (Inside) |
| 2 | 10.000 | 6.500 | INSUL. STUD M6 x 18mm (Inside) |

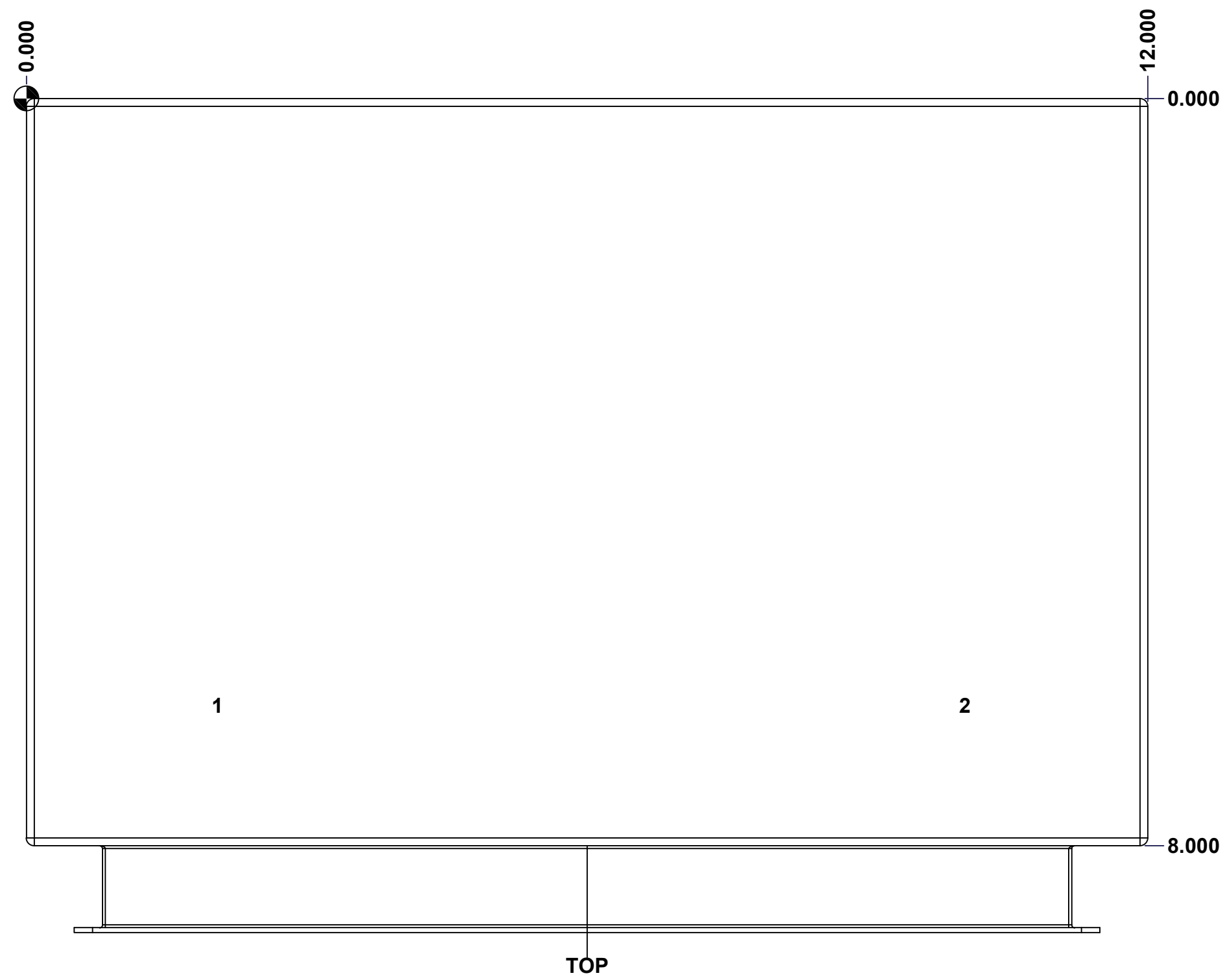

| | | |
|--|-----------------------------|--------------|
| | Description | Status |
| | 5412ESS 30" x 12" x 8" Body | (NULL) |
| | Part Number Numéro Pièce | Rev. |
| | 5412ESS3012086THB | 0 / 4 |
| | | 16 |

This drawing is confidential and must not be reproduced or used without the consent of EXM

Ce dessin est confidentiel et ne doit pas être reproduit ou utilisé sans le consentement de EXM

| STANDARD FEATURES ARE NOT LISTED IN THIS HOLE TABLE | | | |
|--|--------|-------|--------------------------------|
| HOLE TABLE - BOTTOM VIEW (CUSTOM FEATURE ONLY) | | | |
| CUT-OUT | XDIM | YDIM | DESCRIPTION |
| 1 | 2.000 | 6.500 | INSUL. STUD M6 x 18mm (Inside) |
| 2 | 10.000 | 6.500 | INSUL. STUD M6 x 18mm (Inside) |

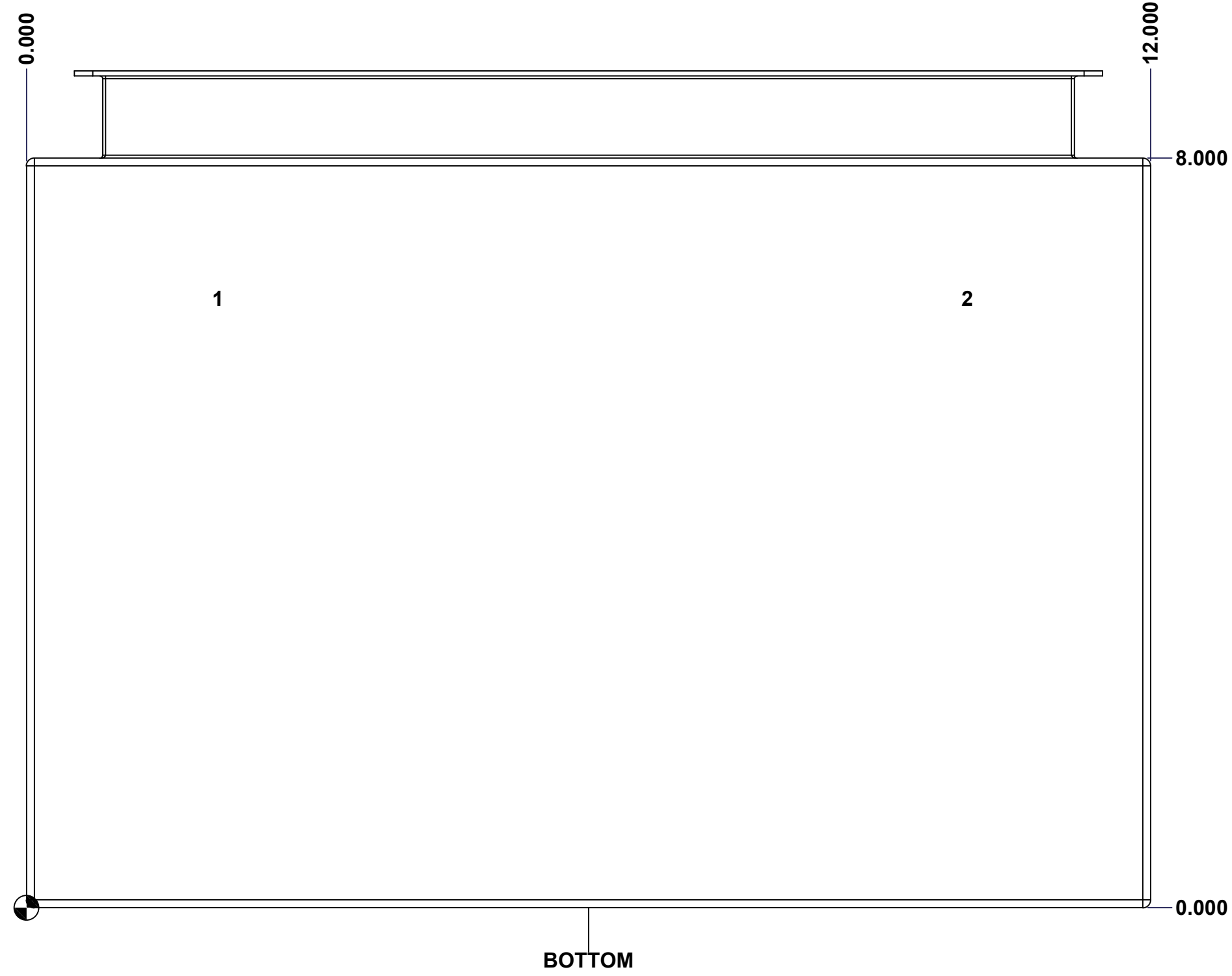

| | | | |
|--|-----------------------------|----------|----|
| | Description | Status | |
| | 5412ESS 30" x 12" x 8" Body | (NULL) | |
| | Part Number Numéro Pièce | Rev. | 5 |
| | 5412ESS3012086THB | 0 | 16 |

This drawing is confidential and must not be reproduced or used without the consent of EXM

Ce dessin est confidentiel et ne doit pas être reproduit ou utilisé sans le consentement de EXM

STANDARD FEATURES ARE NOT LISTED IN THIS HOLE TABLE

HOLE TABLE - BACK VIEW (CUSTOM FEATURE ONLY)

| CUT-OUT | XDIM | YDIM | DESCRIPTION |
|---------|--------|--------|----------------------------|
| 1 | 1.875 | 1.875 | IP STUD M8 x 35mm (Inside) |
| 2 | 1.875 | 28.125 | IP STUD M8 x 35mm (Inside) |
| 3 | 10.125 | 28.125 | IP STUD M8 x 35mm (Inside) |
| 4 | 10.125 | 1.875 | IP STUD M8 x 35mm (Inside) |
| ----- | | | |
| 5 | 11.250 | 0.000 | FOOT 885 ESMF4_OPEN |
| 6 | 0.750 | 0.000 | FOOT 885 ESMF4_OPEN |
| 7 | 11.250 | 30.000 | FOOT 885 ESMF4_CLOSE |
| 8 | 0.750 | 30.000 | FOOT 885 ESMF4_CLOSE |

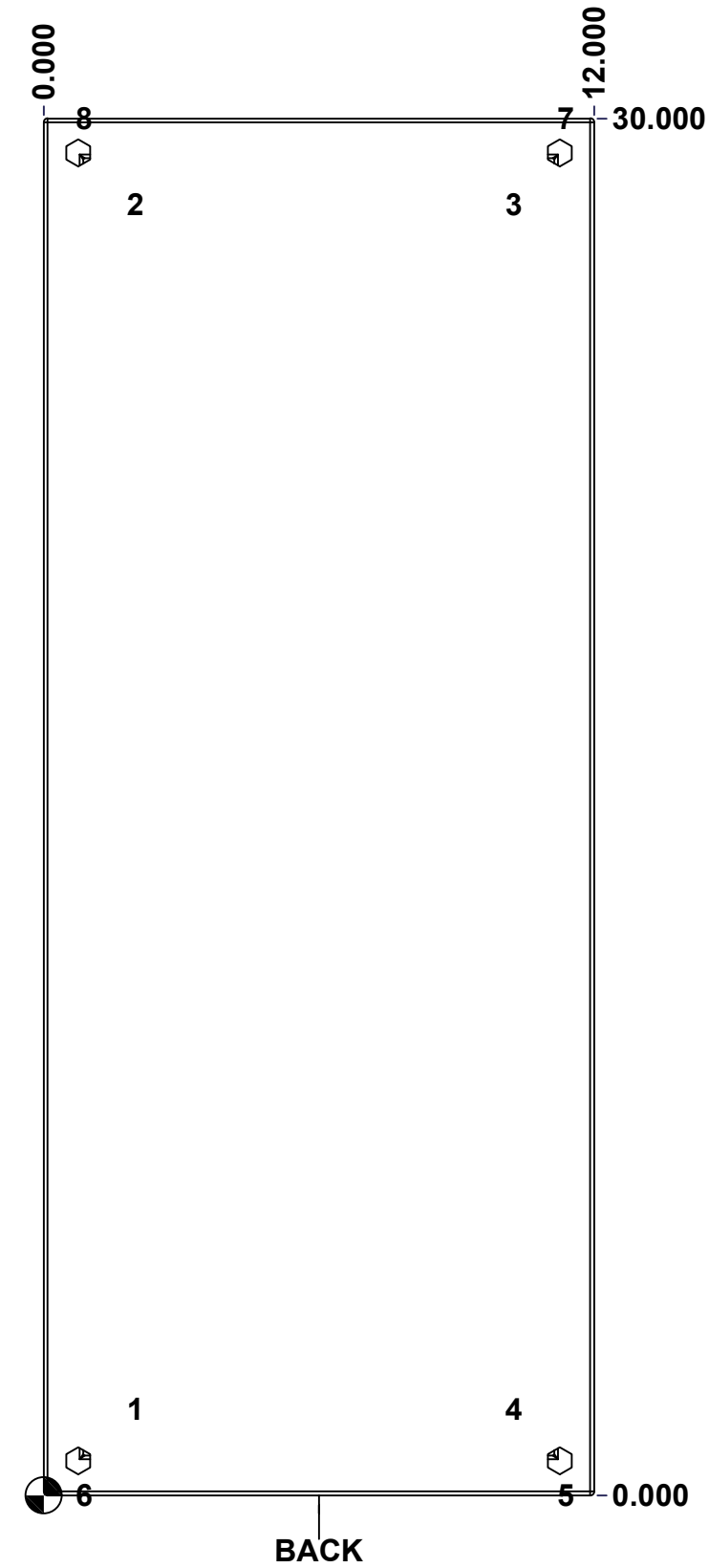

| | | |
|---|-----------------------------|--------|
| | Description | Status |
| | 5412ESS 30" x 12" x 8" Body | (NULL) |
| Part Number Numéro Pièce 5412ESS3012086THB | Rev. | 6 |
| | 0 | 16 |

This drawing is confidential and must not be reproduced or used without the consent of EXM

Ce dessin est confidentiel et ne doit pas être reproduit ou utilisé sans le consentement de EXM

| No. | Revisions | Date | By/Par |
|-----|-----------|------|--------|
| | | | |
| | | | |
| | | | |
| | | | |
| | | | |

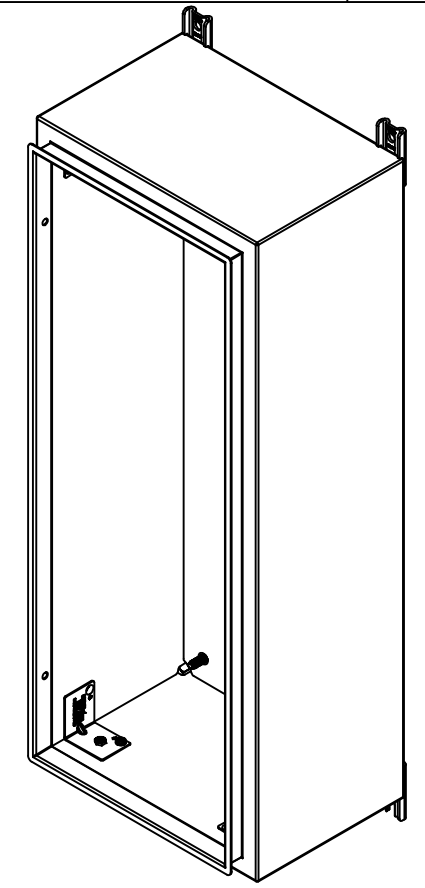

Isometric View



| | | | |
|---|------------------------|---|---|
| 2 | 885ESMF4-FEET | 0 | 885 ESMF4 Stainless Steel Mounting Foot |
| 4 | RIVET_NUT_SS_M10_FH_CE | 0 | Stainless Steel Rivet Nut M10 (Low Profile Close End) |
| 4 | STK-Q-06670 | 2 | M10 x 16mm Stainless Steel Machine Screw |
| 2 | 885ESMF4-FEET-A | 0 | 885 ESMF4 Stainless Steel Mounting Foot (Opened Slot) |
| 1 | STK-K-70554 | 3 | 5412 ESTH Accessory Kit |
| 1 | 5412ESS3012086THI-RS | 0 | 5412ESS 30" x 12" Right Insulation |
| 1 | 5412ESS3012086THI-LS | 0 | 5412ESS 30" x 12" Left Insulation |
| 1 | 5412ESS3012086THI-BT | 0 | 5412ESS 30" x 12" Top and Bottom Insulation |
| 1 | 5412ESS3012086THI-TP | 0 | 5412ESS 30" x 12" Top and Bottom Insulation |
| 1 | 5412ESS3012086THI-B | 0 | 5412ESS 30" x 12" Back Insulation |
| 4 | STK-Q-16070 | 1 | Stud M6 x 18mm Stainless steel |
| 4 | STK-Q-16020 | 1 | Stud M8 x 35mm Stainless Steel |
| 1 | 5412ESS3012086THB-P | 0 | 5412ESS 30" x 12" x 8" Body Part |

| Qty | Part Number | Rev | Description |
|------------|-------------|-----|-------------|
| Parts List | | | |

| | | |
|---|--|--|
| | Tél: (450) 979-4373 Fax: (450) 979-4626 www.exmweb.com | Flatness Aplatissement Max 3.0mm |
| | Projection | Customer Client |
| Drawn By Dessiné Par | BoxCad: BoxCad | Date 30-May-23 |
| Material Matière | 16 Ga Stainless Steel 316 (1.4mm) | |
| Color Couleur | Unpainted | Finish Fini Brushed |
| Description 5412ESS 30" x 12" x 8" Body | Detail Rev. | |
| Part Number Numéro Pièce 5412ESS3012086THB | Rev. 0 | 7 16 |

This drawing is confidential and must not be reproduced or used without the consent of EXM

Ce dessin est confidentiel et ne doit pas être reproduit ou utilisé sans le consentement de EXM

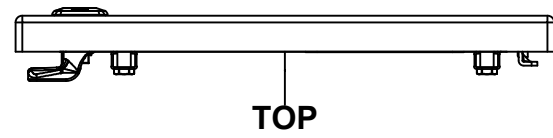

TOP

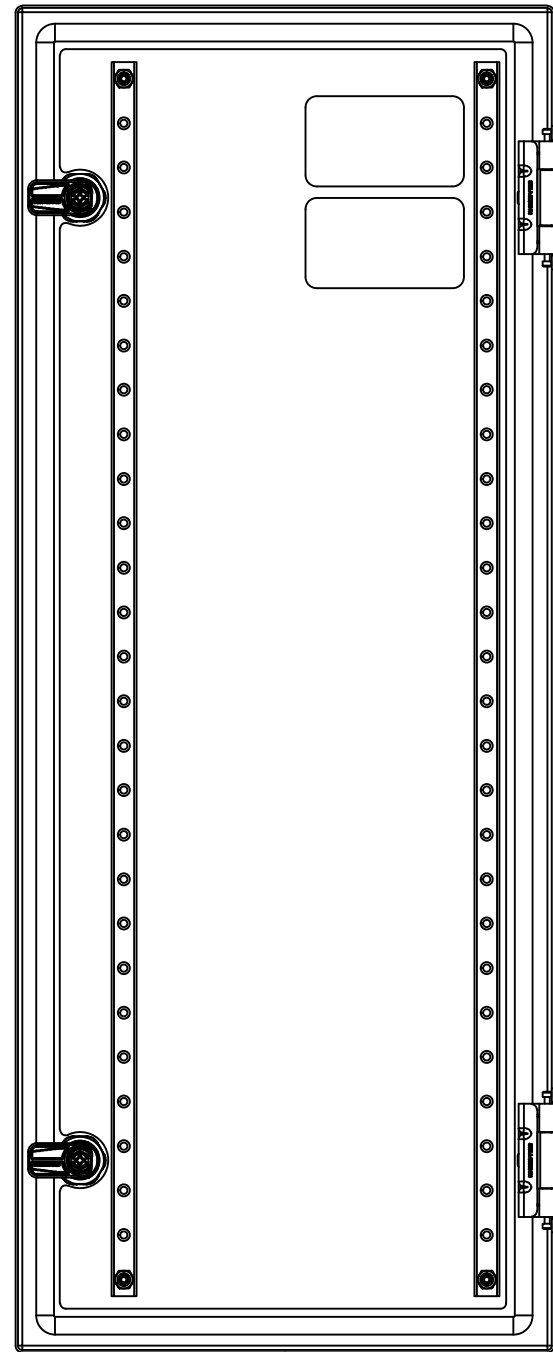

BACK

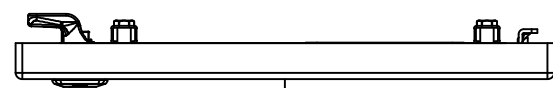

BOTTOM

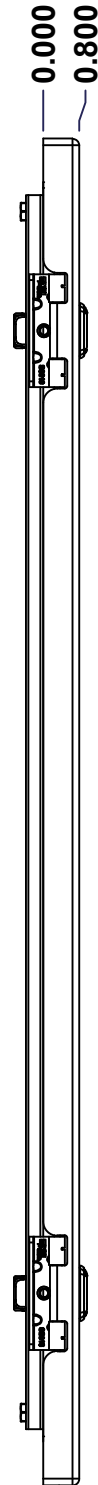

LEFT

0.000
0.800

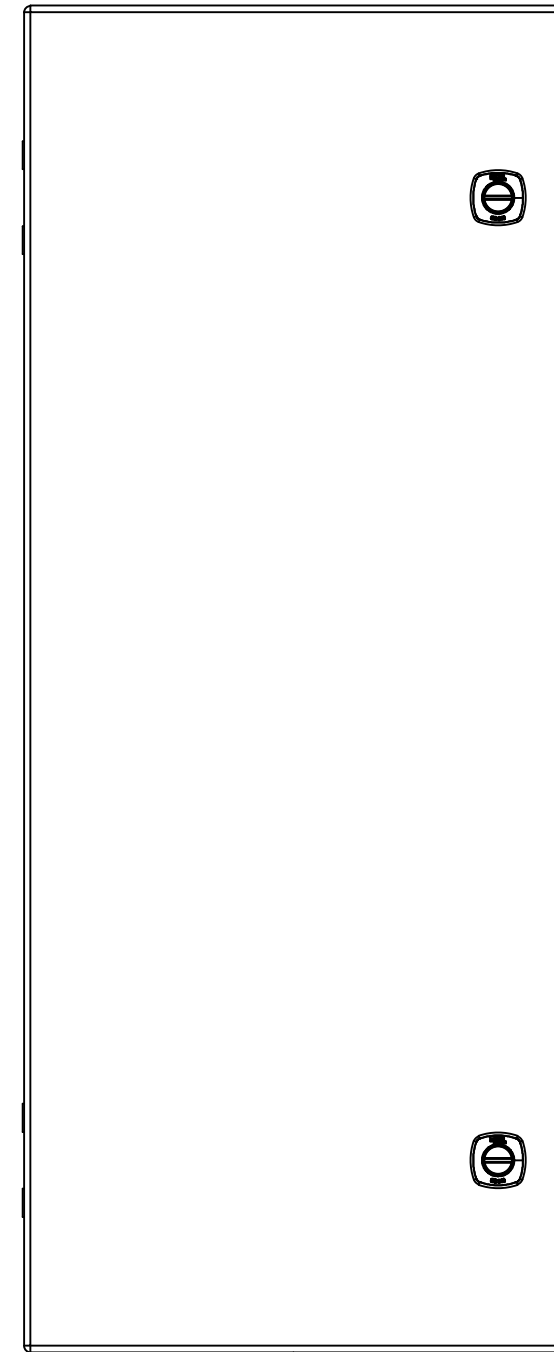

FRONT

0.000
11.918

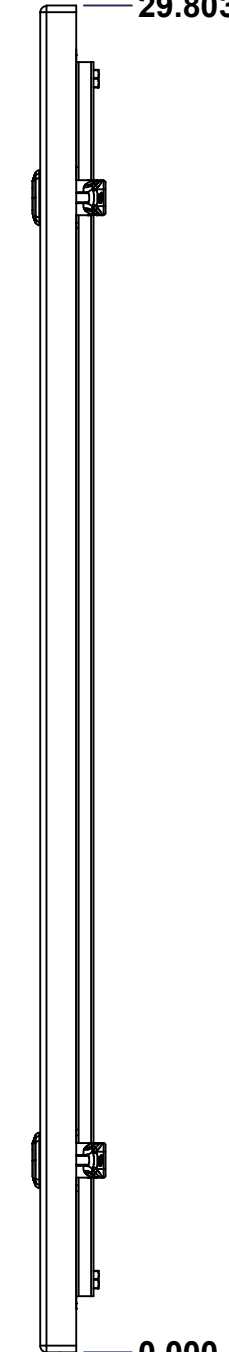

RIGHT

29.803

0.000

| No. | Revisions | Date | By/Par |
|-----|-----------|------|--------|
| | | | |
| | | | |
| | | | |
| | | | |
| | | | |

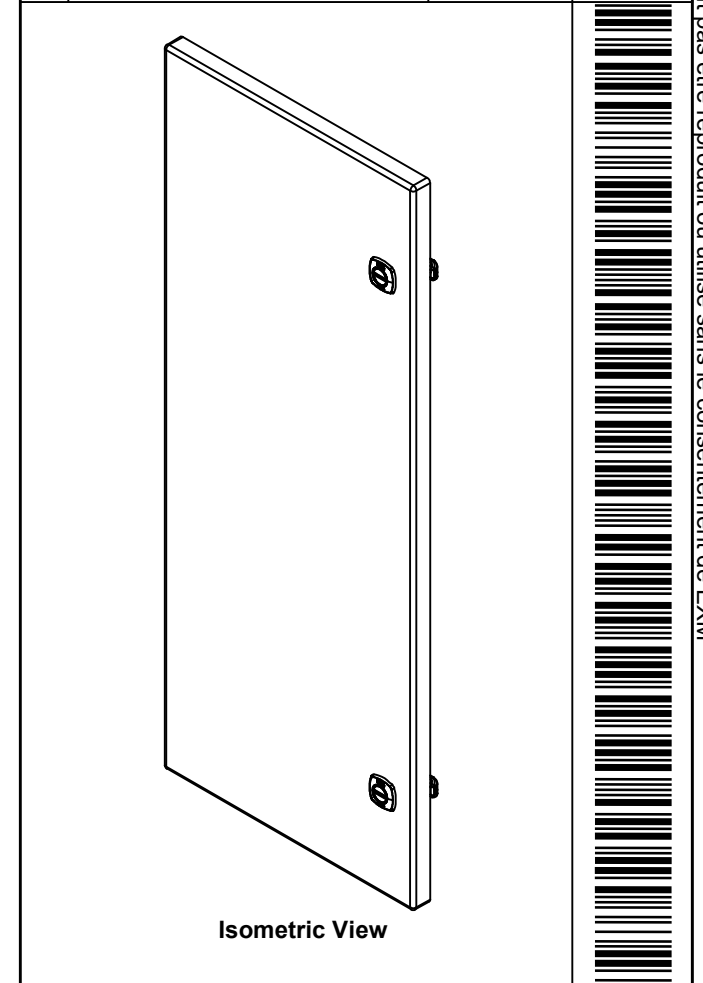

Isometric View

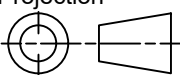

| | | |
|--|-----------------------------------|---|
|  Tél: (450) 979-4373 Fax: (450) 979-4626 www.exmweb.com | | Flatness Aplatissement Max 3.0mm Projection  |
| Customer Client | Date | |
| Drawn By Dessiné Par | BoxCad: BoxCad | Date 30-May-23 |
| Material Matière | 16 Ga Stainless Steel 316 (1.4mm) | |
| Color Couleur | Unpainted | Finish Fini Brushed |
| Description 5412ESS 30" x 12" Cover | | Detail Rev. |
| Part Number Numéro Pièce | Rev. 0 | 8 / 16 |

SEE BILL OF MATERIAL ON LAST PAGE

5412ESS3012086THC

This drawing is confidential and must not be reproduced or used without the consent of EXM

Ce dessin est confidentiel et ne doit pas être reproduit ou utilisé sans le consentement de EXM

STANDARD FEATURES ARE NOT LISTED IN THIS HOLE TABLE

HOLE TABLE - FRONT VIEW (CUSTOM FEATURE ONLY)

| CUT-OUT | XDIM | YDIM | DESCRIPTION |
|---------|--------|--------|-------------------------|
| 1 | 1.486 | 1.614 | STUD M6 x 18mm (Inside) |
| 2 | 1.486 | 28.189 | STUD M6 x 18mm (Inside) |
| 3 | 9.517 | 28.189 | STUD M6 x 18mm (Inside) |
| 4 | 9.517 | 1.614 | STUD M6 x 18mm (Inside) |
| ----- | | | |
| 5 | 10.494 | 25.553 | 880 SCQ4-SLSS6 |
| 6 | 10.494 | 4.250 | 880 SCQ4-SLSS6 |

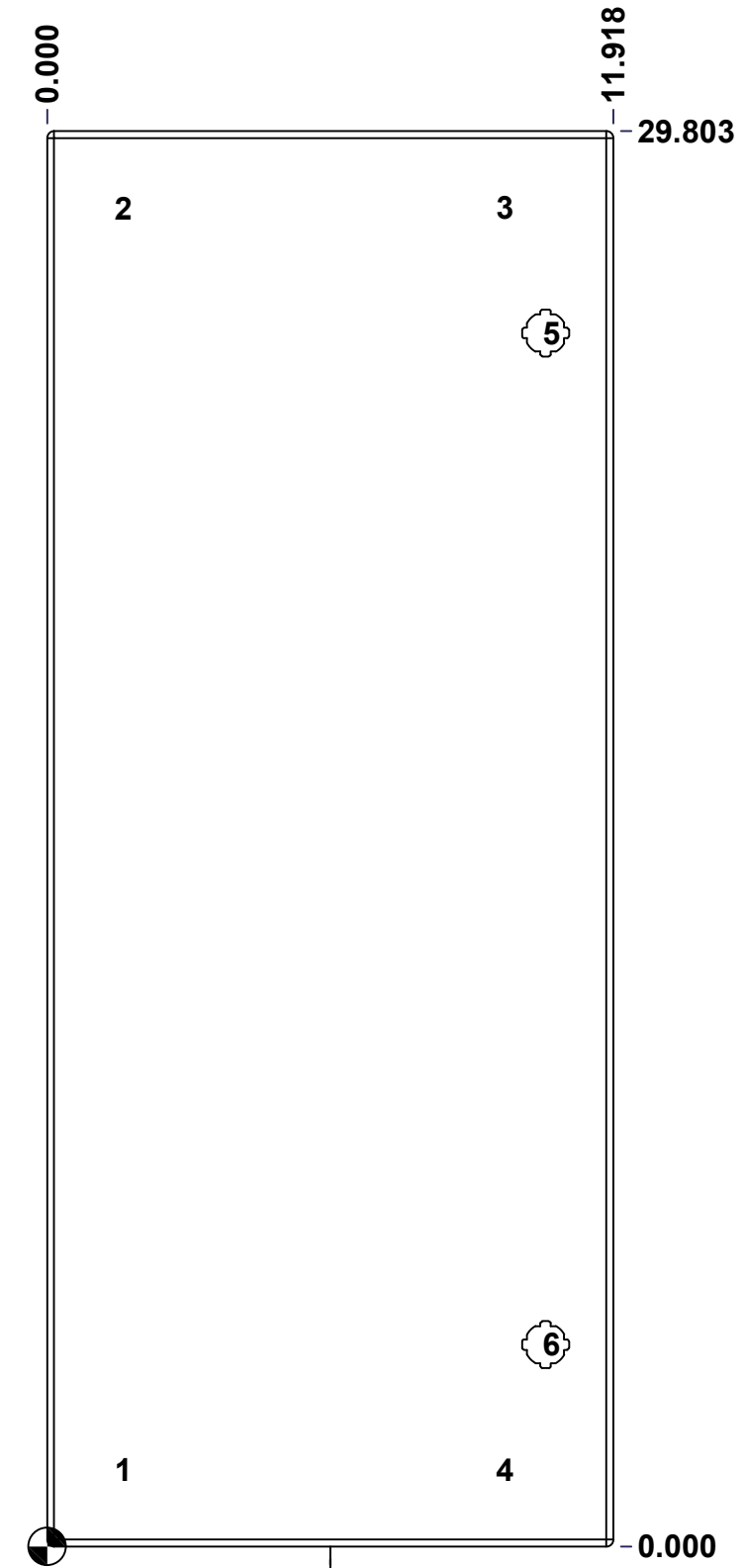

FRONT

| | | |
|--|-----------------------------|--------------|
| | Description | Status |
| | 5412ESS 30" x 12" Cover | (NULL) |
| | Part Number Numéro Pièce | Rev. |
| | 5412ESS3012086THC | 0 / 9 |
| | | 16 |

This drawing is confidential and must not be reproduced or used without the consent of EXM

Ce dessin est confidentiel et ne doit pas être reproduit ou utilisé sans le consentement de EXM

| No. | Revisions | Date | By/Par |
|-----|-----------|------|--------|
| | | | |
| | | | |
| | | | |
| | | | |
| | | | |

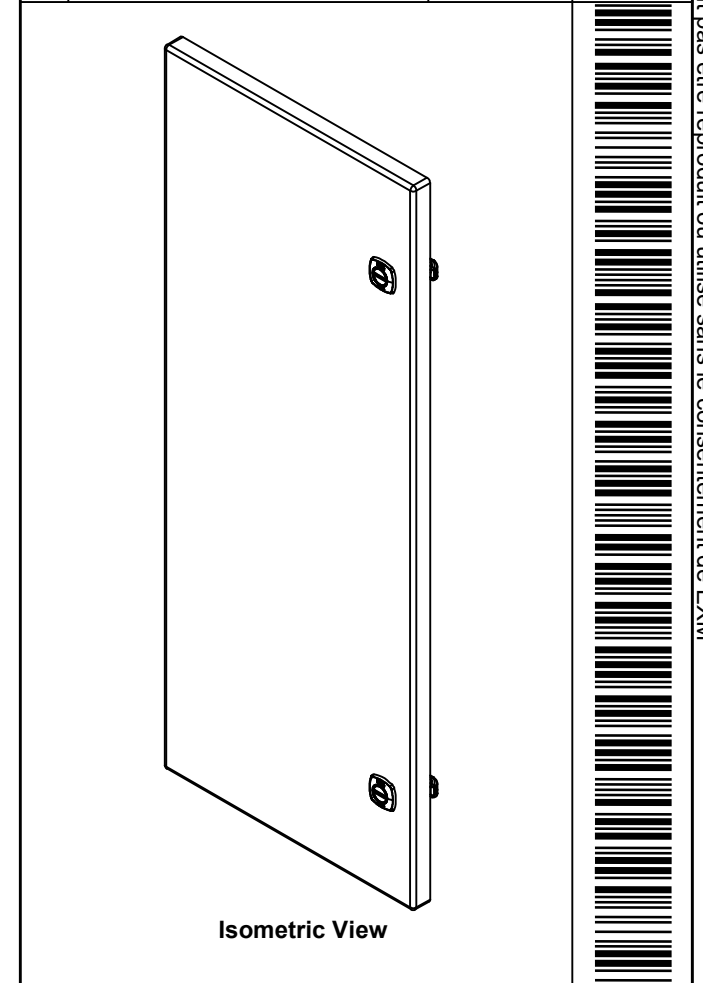

Isometric View

 Tél: (450) 979-4373
 Fax: (450) 979-4626
www.exmweb.com

Flatness
 Aplatissement
 Max 3.0mm
 Projection

| | |
|-------------------------|----------------|
| Customer Client | Date |
| Drawn By Dessiné Par | Date 30-May-23 |

Material Matière: 16 Ga Stainless Steel 316 (1.4mm)

| | | | |
|---------------|-----------|-------------|---------|
| Color Couleur | Unpainted | Finish Fini | Brushed |
|---------------|-----------|-------------|---------|

| | |
|-------------------------|-------------|
| Description | Detail Rev. |
| 5412ESS 30" x 12" Cover | |

| | | |
|-----------------------------|----------|----|
| Part Number Numéro Pièce | Rev. | 10 |
| 5412ESS3012086THC | 0 | 16 |

| QTY | Part Number | Rev | Description |
|------------|---------------------|-----|--|
| 2 | STK-S-00100 | 0 | 3.5" x 2" Silver Milar Flexcon Sticker |
| 4 | STK-Q-07250 | 2 | M6 x 16mm Collar Nut |
| 2 | STK-Q-46020-30 | 5 | 5412 ES Vertical Door Stiffener 30" |
| 1 | 5412ESS3012086THI-C | 0 | 5412ESS 30" x 12" Cover Insulation |
| 4 | STK-Q-16070 | 1 | Stud M6 x 18mm Stainless steel |
| 1 | 5412ESS3012086THG | 0 | 5412ESS 30" x 12" Cover Gasket Part |
| 1 | 5412ESS3012086THC-P | 0 | 5412ESS 30" x 12" Cover Part |
| 2 | 880 SCQ4-SLSS6 | 7 | 5412 ESS 1/4 Turn Lock |
| 2 | STK-A-33016 | 0 | 5412 ESS Bended Hinge (Body Part) |
| Parts List | | | |

This drawing is confidential and must not be reproduced or used without the consent of EXM

Ce dessin est confidentiel et ne doit pas être reproduit ou utilisé sans le consentement de EXM

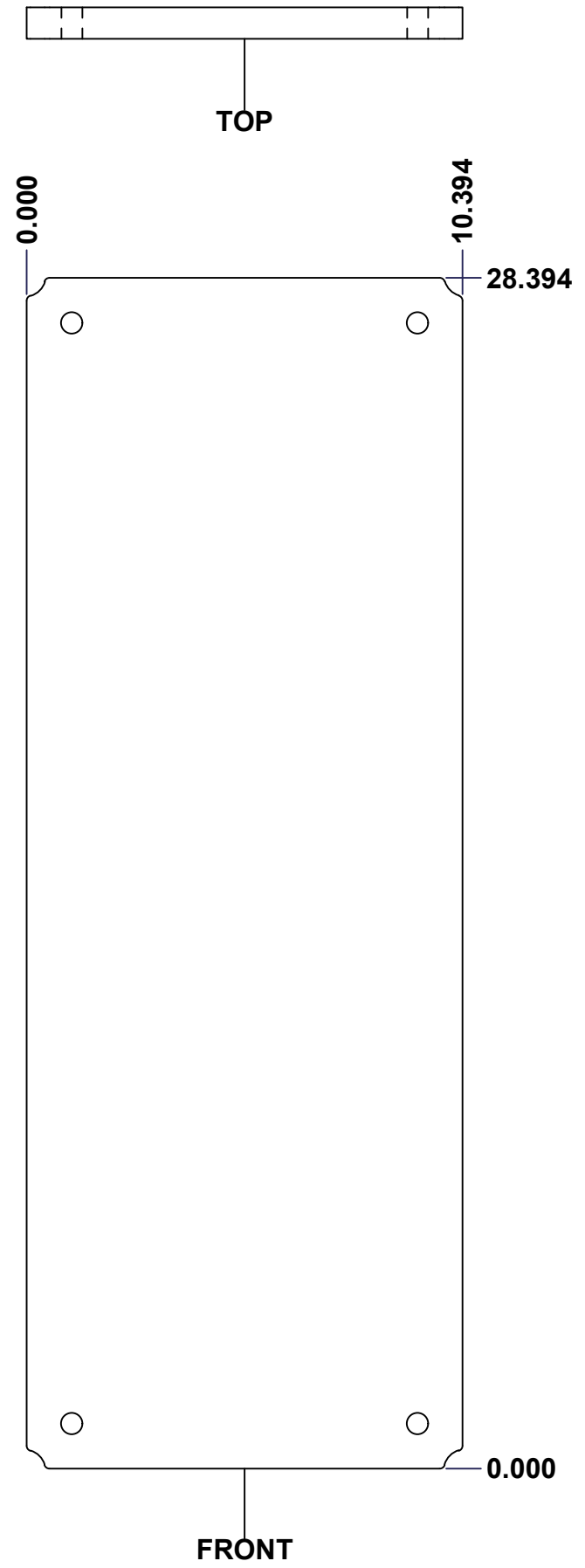

| No. | Revisions | Date | By/Par |
|-----|-----------|------|--------|
| | | | |
| | | | |
| | | | |
| | | | |
| | | | |

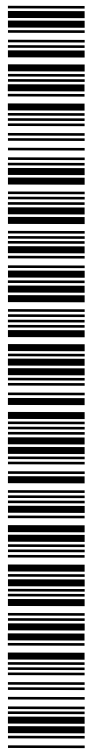
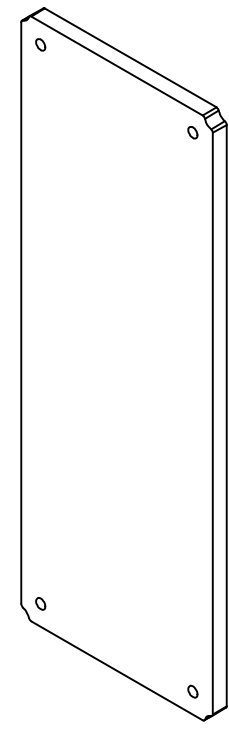

Isometric View



Tél: (450) 979-4373
 Fax: (450) 979-4626
www.exmweb.com

Flatness
 Aplatissement
 Max 3.0mm
 Projection

| | |
|---|--------------------|
| Customer Client | Date |
| Drawn By / Dessiné Par: BoxCad: Patrick Deschenes | Date: 23-Jan-07 |
| Material / Matière: Polyisocyanurate | |
| Color / Couleur: Aluminum | Finish / Fini: N/A |

Description: 5412ESS 30" x 12" Back Insulation
 Detail Rev.

| | | |
|--|--------|---------|
| Part Number / Numéro Pièce: 5412ESS3012086TH-B | Rev. 0 | 11 / 16 |
|--|--------|---------|

SEE BILL OF MATERIAL ON LAST PAGE

This drawing is confidential and must not be reproduced or used without the consent of EXM

Ce dessin est confidentiel et ne doit pas être reproduit ou utilisé sans le consentement de EXM

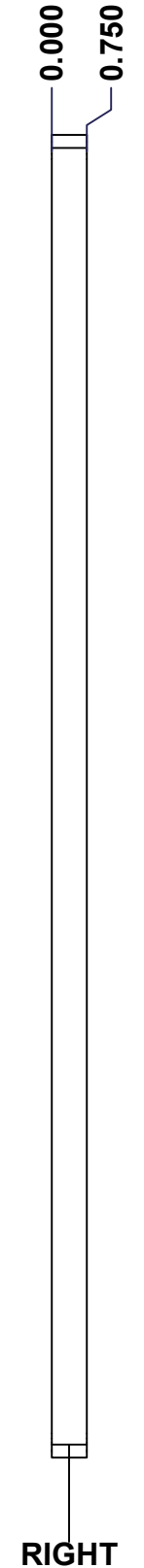
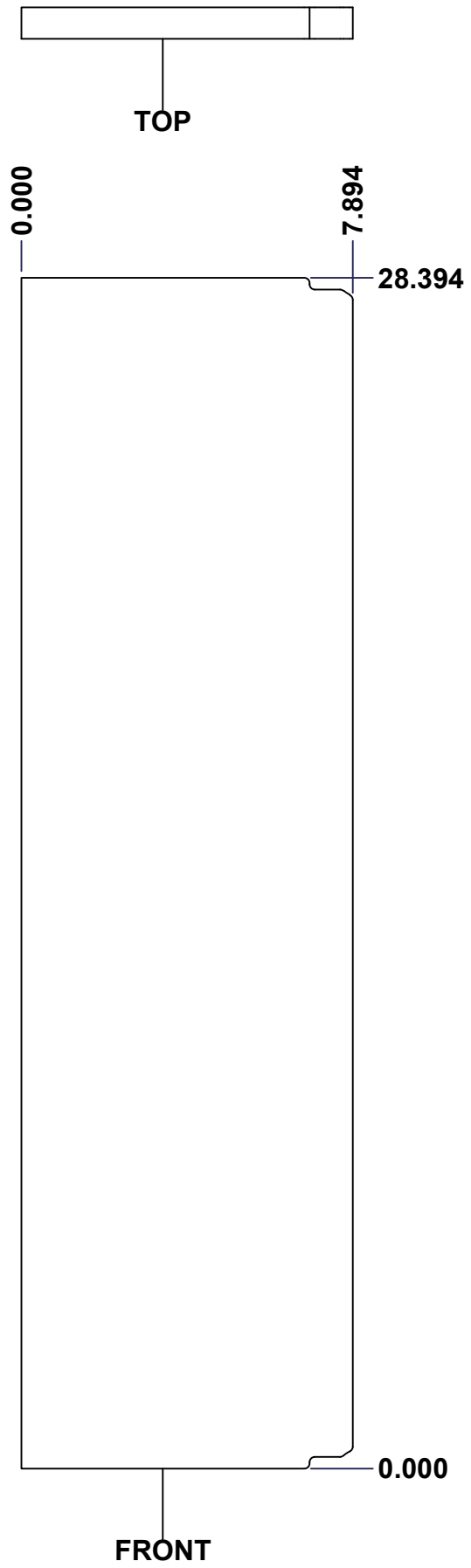

| No. | Revisions | Date | By/Par |
|-----|-----------|------|--------|
| | | | |
| | | | |
| | | | |
| | | | |
| | | | |

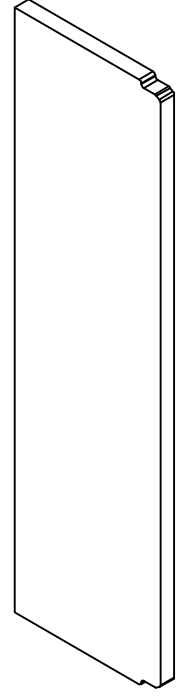

Isometric View



| | | | |
|--|----------|---------------------------|-------------|
|  Tél: (450) 979-4373 Fax: (450) 979-4626 www.exmweb.com | | Flatness Aplatissement | |
| | | Max 3.0mm | |
| Customer Client | | Date | |
| Drawn By Dessiné Par | | Date 23-Jan-07 | |
| Material Matière | | Polyisocyanurate | |
| Color Couleur | Aluminum | Finish Fini | N/A |
| Description | | | Detail Rev. |
| 5412ESS 30" x 12" Left Insulation | | | |
| Part Number Numéro Pièce | | Rev. | 12 |
| 5412ESS3012086THI-LS | | 0 | 16 |

SEE BILL OF MATERIAL ON LAST PAGE

This drawing is confidential and must not be reproduced or used without the consent of EXM

Ce dessin est confidentiel et ne doit pas être reproduit ou utilisé sans le consentement de EXM

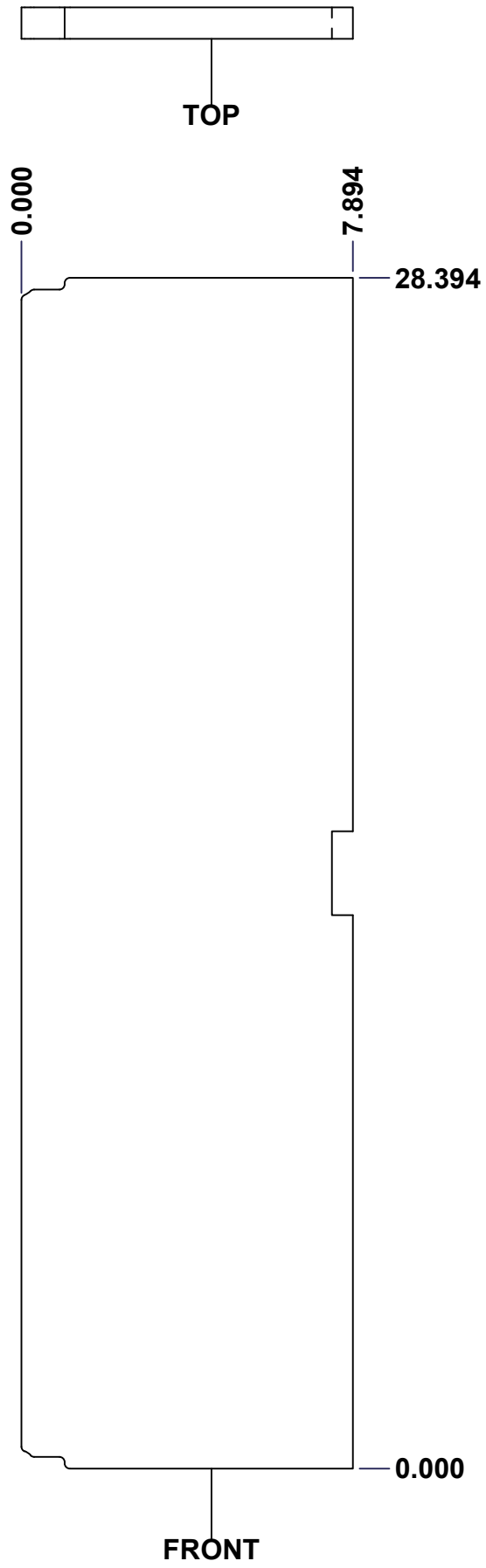

SEE BILL OF MATERIAL ON LAST PAGE

| No. | Revisions | Date | By/Par |
|-----|-----------|------|--------|
| | | | |
| | | | |
| | | | |
| | | | |
| | | | |

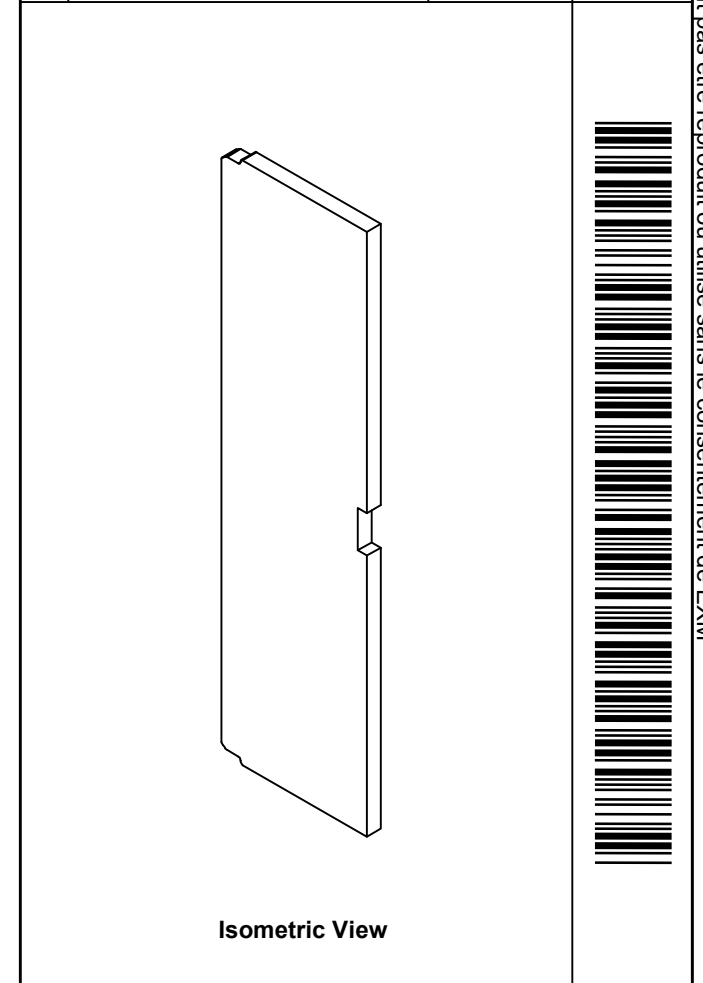

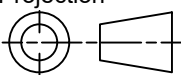
| | | |
|--|--------------------|---|
|  Tél: (450) 979-4373 Fax: (450) 979-4626 www.exmweb.com | | Flatness Aplatissement Max 3.0mm |
| Customer Client | | Projection  |
| Drawn By / Dessiné Par: BoxCad: Patrick Deschenes | | Date: 23-Jan-07 |
| Material / Matière: Polyisocyanurate | | |
| Color / Couleur: Aluminum | Finish / Fini: N/A | |
| Description: 5412ESS 30" x 12" Right Insulation | | Detail Rev. |
| Part Number / Numéro Pièce: 5412ESS3012086THI-RS | | Rev. 13 0 |



This drawing is confidential and must not be reproduced or used without the consent of EXM

Ce dessin est confidentiel et ne doit pas être reproduit ou utilisé sans le consentement de EXM

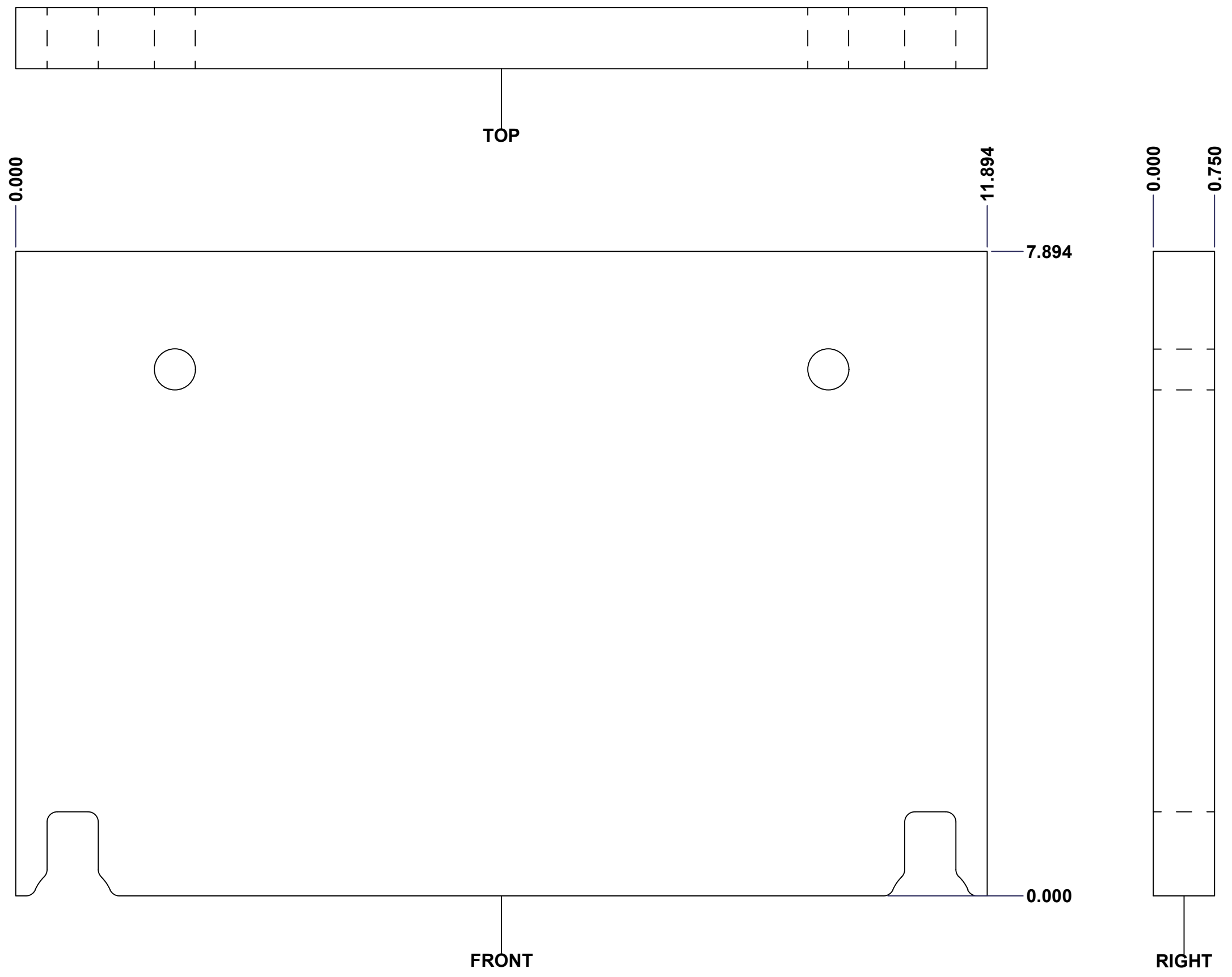

| No. | Revisions | Date | By/Par |
|-----|-----------|------|--------|
| | | | |
| | | | |
| | | | |
| | | | |
| | | | |

Isometric View

| | | |
|---|---|--------------------|
| <p>Tél: (450) 979-4373 Fax: (450) 979-4626 www.exmweb.com</p> | Flatness Aplatissement | Max 3.0mm |
| | Projection | |
| Customer Client | Date | |
| Drawn By Dessiné Par | BoxCad: Patrick Deschenes | Date 23-Jan-07 |
| Material Matière | Polyisocyanurate | |
| Color Couleur | Aluminum | Finish Fini N/A |
| Description | 5412ESS 30" x 12" Top and Bottom Insulation | |
| Part Number Numéro Pièce | Rev. 0 | 14 / 16 |

SEE BILL OF MATERIAL ON LAST PAGE

5412ESS3012086THI-TP

This drawing is confidential and must not be reproduced or used without the consent of EXM

Ce dessin est confidentiel et ne doit pas être reproduit ou utilisé sans le consentement de EXM

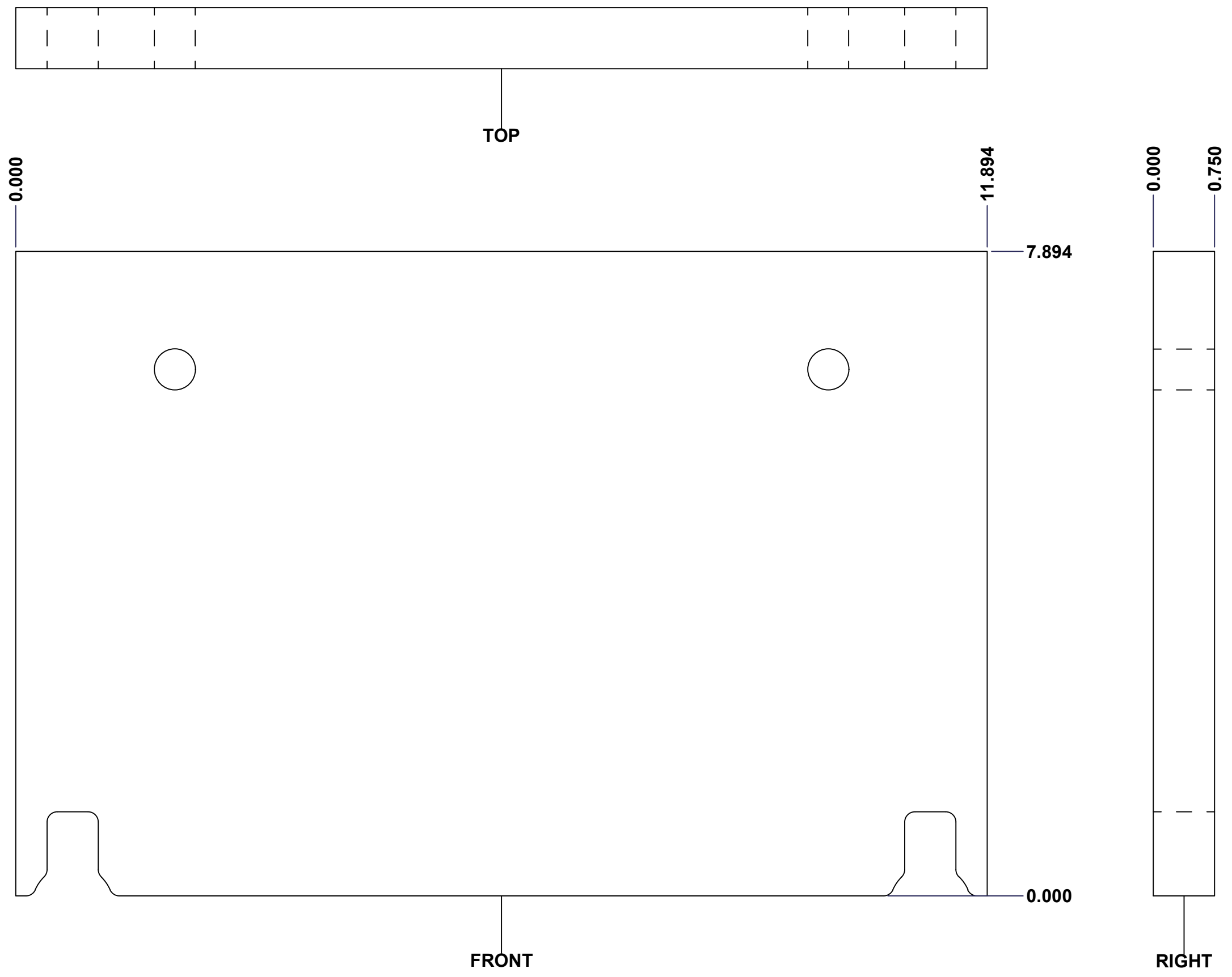

| No. | Revisions | Date | By/Par |
|-----|-----------|------|--------|
| | | | |
| | | | |
| | | | |
| | | | |
| | | | |

Isometric View

| | | |
|---|---|--------------------|
| <p>Tél: (450) 979-4373 Fax: (450) 979-4626 www.exmweb.com</p> | Flatness Aplatissement | Max 3.0mm |
| | Projection | |
| Customer Client | Date | |
| Drawn By Dessiné Par | BoxCad: Patrick Deschenes | Date 23-Jan-07 |
| Material Matière | Polyisocyanurate | |
| Color Couleur | Aluminum | Finish Fini N/A |
| Description | 5412ESS 30" x 12" Top and Bottom Insulation | |
| Part Number Numéro Pièce | Rev. 0 | 15 / 16 |

SEE BILL OF MATERIAL ON LAST PAGE

5412ESS3012086THI-BT

This drawing is confidential and must not be reproduced or used without the consent of EXM

Ce dessin est confidentiel et ne doit pas être reproduit ou utilisé sans le consentement de EXM

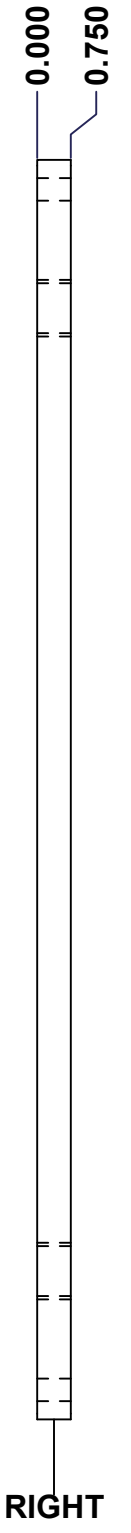
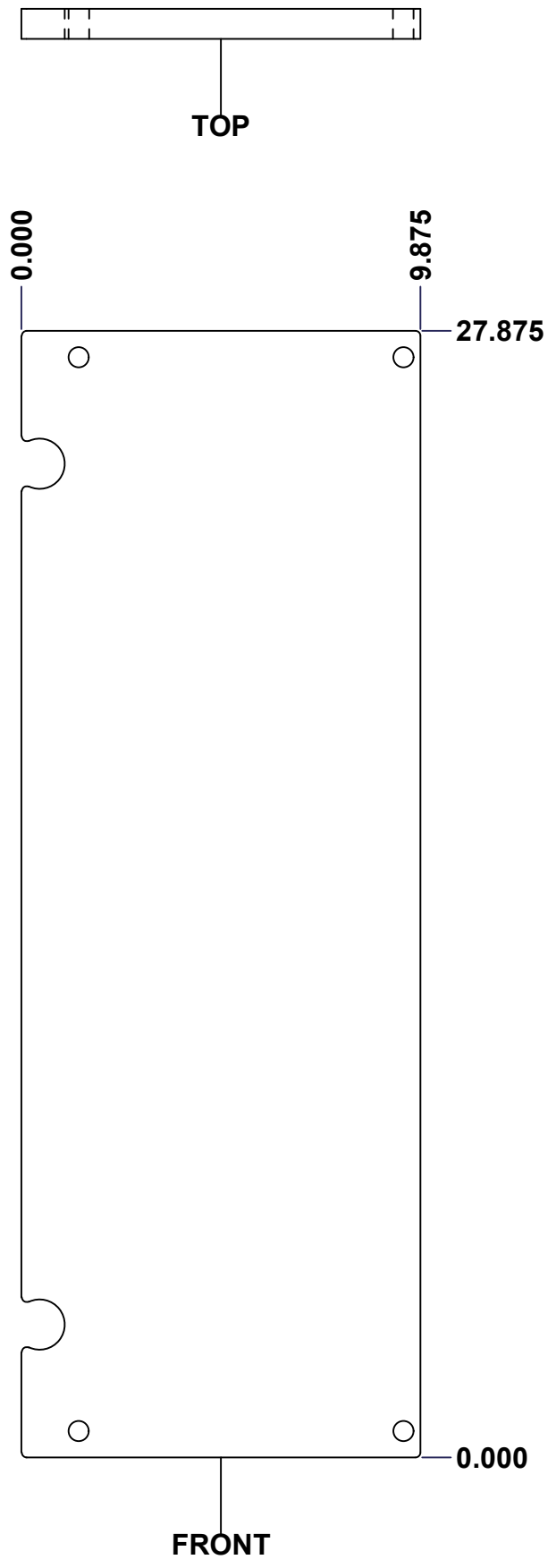

| No. | Revisions | Date | By/Par |
|-----|-----------|------|--------|
| | | | |
| | | | |
| | | | |
| | | | |
| | | | |

Isometric View

| | | |
|---|---------------------------|---------------------------|
| <p>Tél: (450) 979-4373 Fax: (450) 979-4626 www.exmweb.com</p> | | Flatness Aplatissement |
| | | Max 3.0mm |
| | | Projection |
| Customer Client | Date | Date |
| Drawn By Dessiné Par | BoxCad: Patrick Deschenes | Date 23-Jan-07 |
| Material Matière | Polyisocyanurate | |
| Color Couleur | Aluminum | Finish Fini N/A |
| Description | Detail Rev. | |
| 5412ESS 30" x 12" Cover Insulation | | |
| Part Number Numéro Pièce | Rev. 0 | 16 / 16 |
| 5412ESS3012086THI-C | | |

SEE BILL OF MATERIAL ON LAST PAGE

This drawing is confidential and must not be reproduced or used without the consent of EXM

Ce dessin est confidentiel et ne doit pas être reproduit ou utilisé sans le consentement de EXM

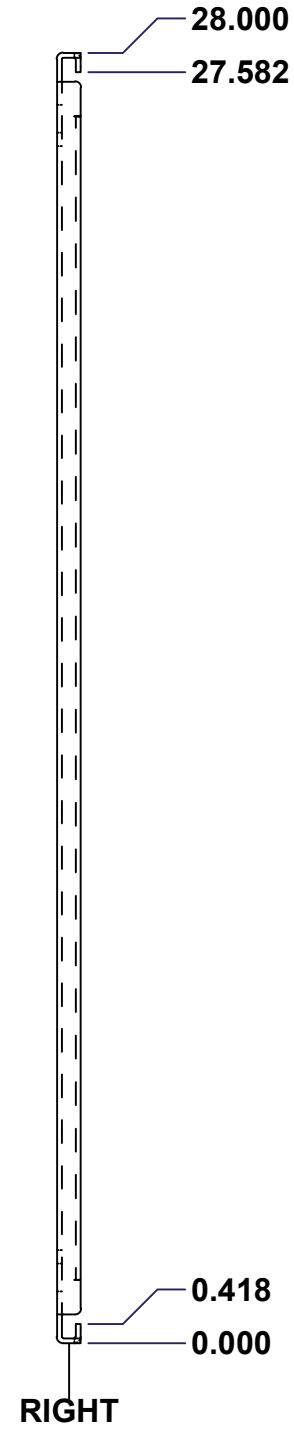
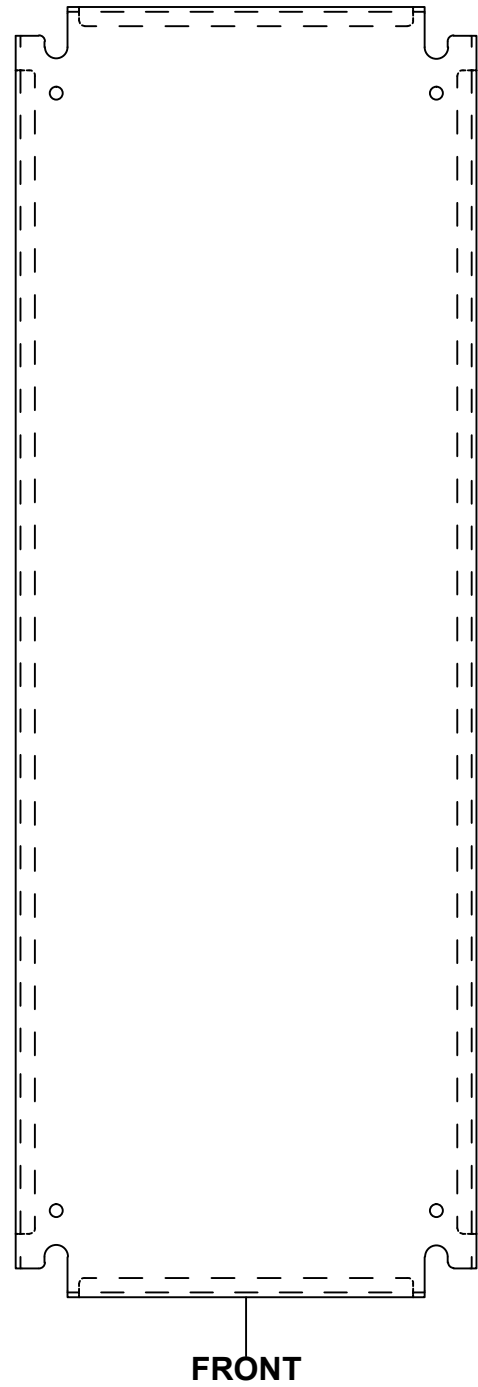
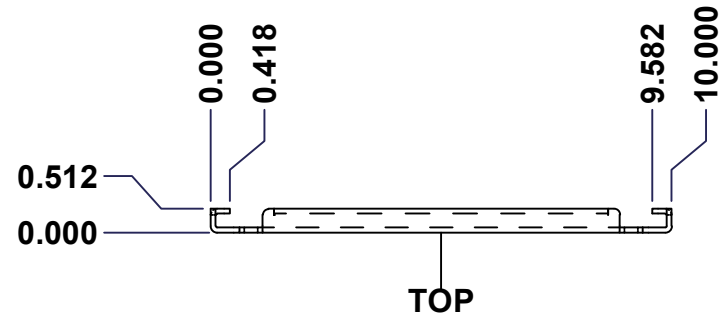

| No. | Revisions | Date | By/Par |
|-----|-----------|------|--------|
| | | | |
| | | | |
| | | | |
| | | | |
| | | | |

Isometric View

| | | |
|--|---------------|--|
| Tél: (450) 979-4373 Fax: (450) 979-4626 www.exmweb.com | | Flatness Aplatissement Max 3.0mm Projection |
| Customer Client | Date | |
| Drawn By Dessiné Par | BoxCad | Date 23-Jan-07 |
| Material Matière | See Part List | |
| Color Couleur | See Part List | Finish Fini See Part List |
| Description | Detail Rev. | |
| 881 SP - Inner Panel | | |
| Part Number Numéro Pièce | Rev. | 1 |
| 881 SP3012G | 0 | 2 |

| Qty | Part Number | Rev | Description | Material | Color | Finish |
|-----|---------------|-----|---------------------------|------------------|-----------|------------|
| 1 | 881 SP3012G-P | 0 | 881 SP - Inner Panel Part | 12 Ga Galvanized | Unpainted | Galvanized |

Parts List

This drawing is confidential and must not be reproduced or used without the consent of EXM

Ce dessin est confidentiel et ne doit pas être reproduit ou utilisé sans le consentement de EXM

| Table 1 | | | FRONT VIEW |
|---------|-------|--------|--------------------------|
| CUT-OUT | XDIM | YDIM | DESCRIPTION |
| 1 | 0.875 | 1.875 | GROUND HOLE (RND Ø0.290) |
| 2 | 9.125 | 1.875 | GROUND HOLE (RND Ø0.290) |
| 3 | 0.875 | 26.125 | GROUND HOLE (RND Ø0.290) |
| 4 | 9.125 | 26.125 | GROUND HOLE (RND Ø0.290) |

All knockouts are actual size / Les disques défonçables sont grandeur réel

| No. | Revisions | Date | By/Par |
|-----|-----------|------|--------|
| | | | |
| | | | |
| | | | |
| | | | |
| | | | |

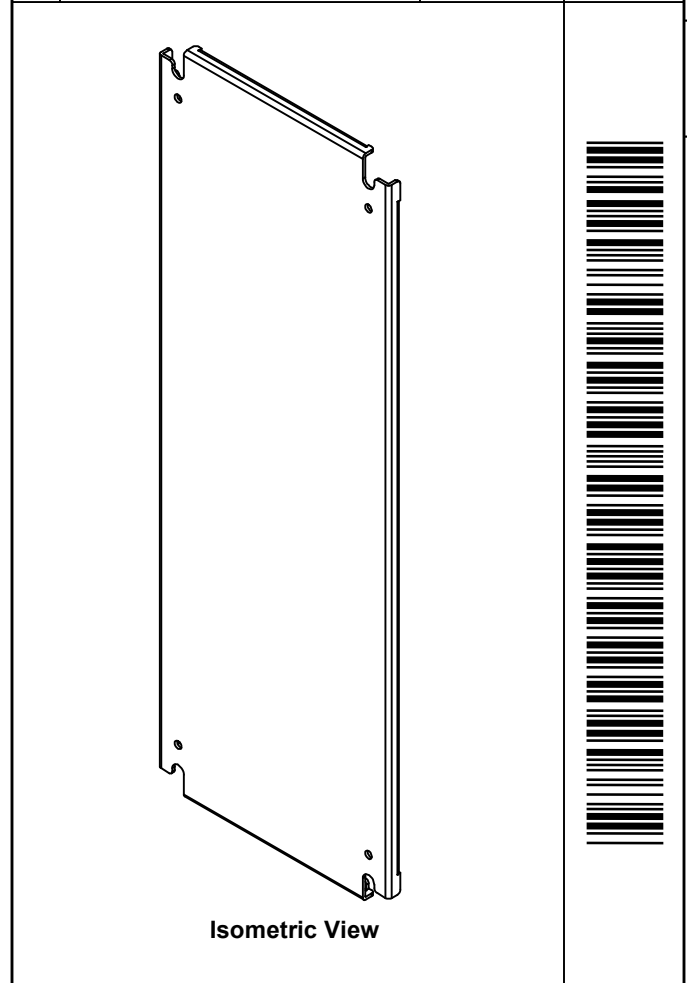
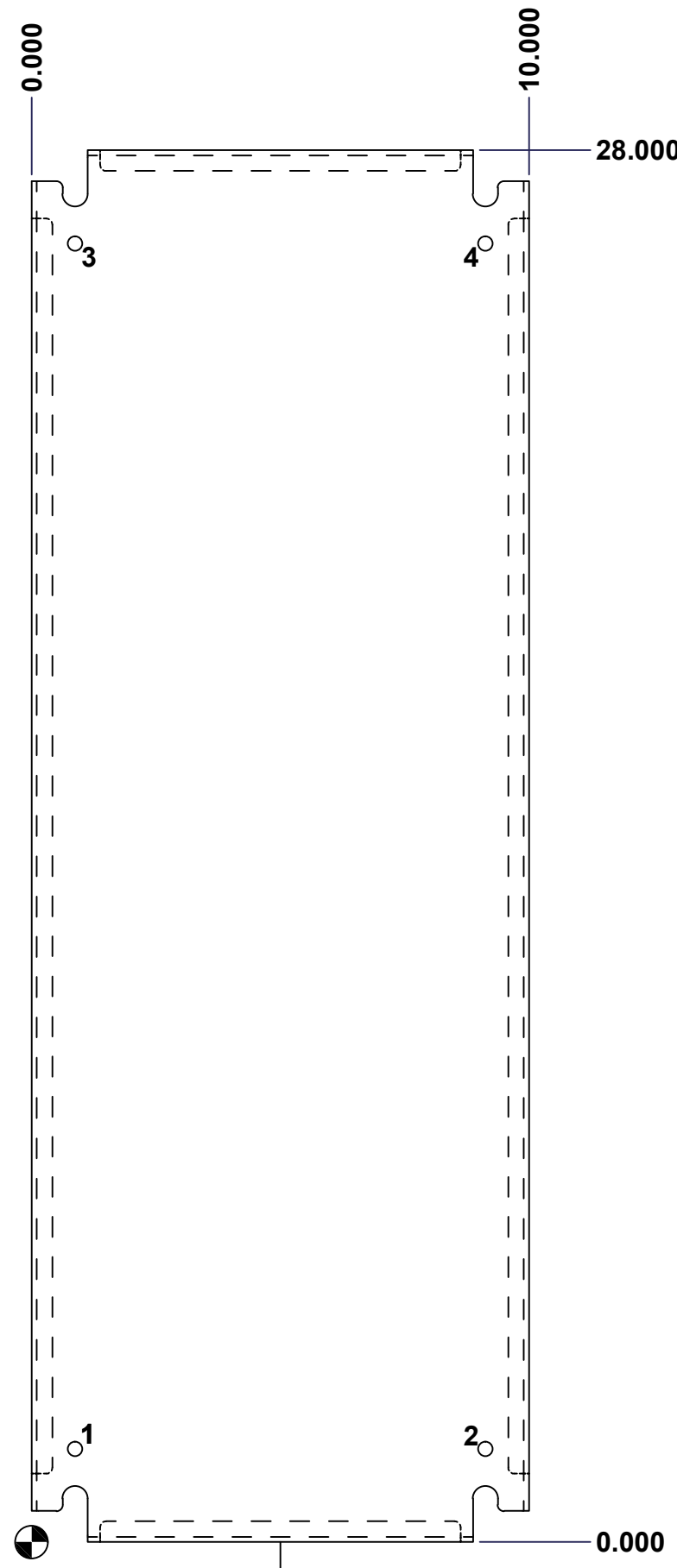

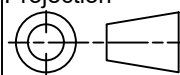
| | | |
|--|---------------|---|
|  Tél: (450) 979-4373 Fax: (450) 979-4626 www.exmweb.com | | Flatness Aplatissement Max 3.0mm Projection  |
| Customer Client | | Date |
| Drawn By Dessiné Par | BoxCad | Date 23-Jan-07 |
| Material Matière | See Part List | |
| Color Couleur | See Part List | Finish Fini See Part List |
| Description 881 SP - Inner Panel | | Detail Rev. |
| Part Number Numéro Pièce | 881 SP3012G | Rev. 2 0 |