

This drawing is confidential and must not be reproduced or used without the consent of EXM

Ce dessin est confidentiel et ne doit pas être reproduit ou utilisé sans le consentement de EXM

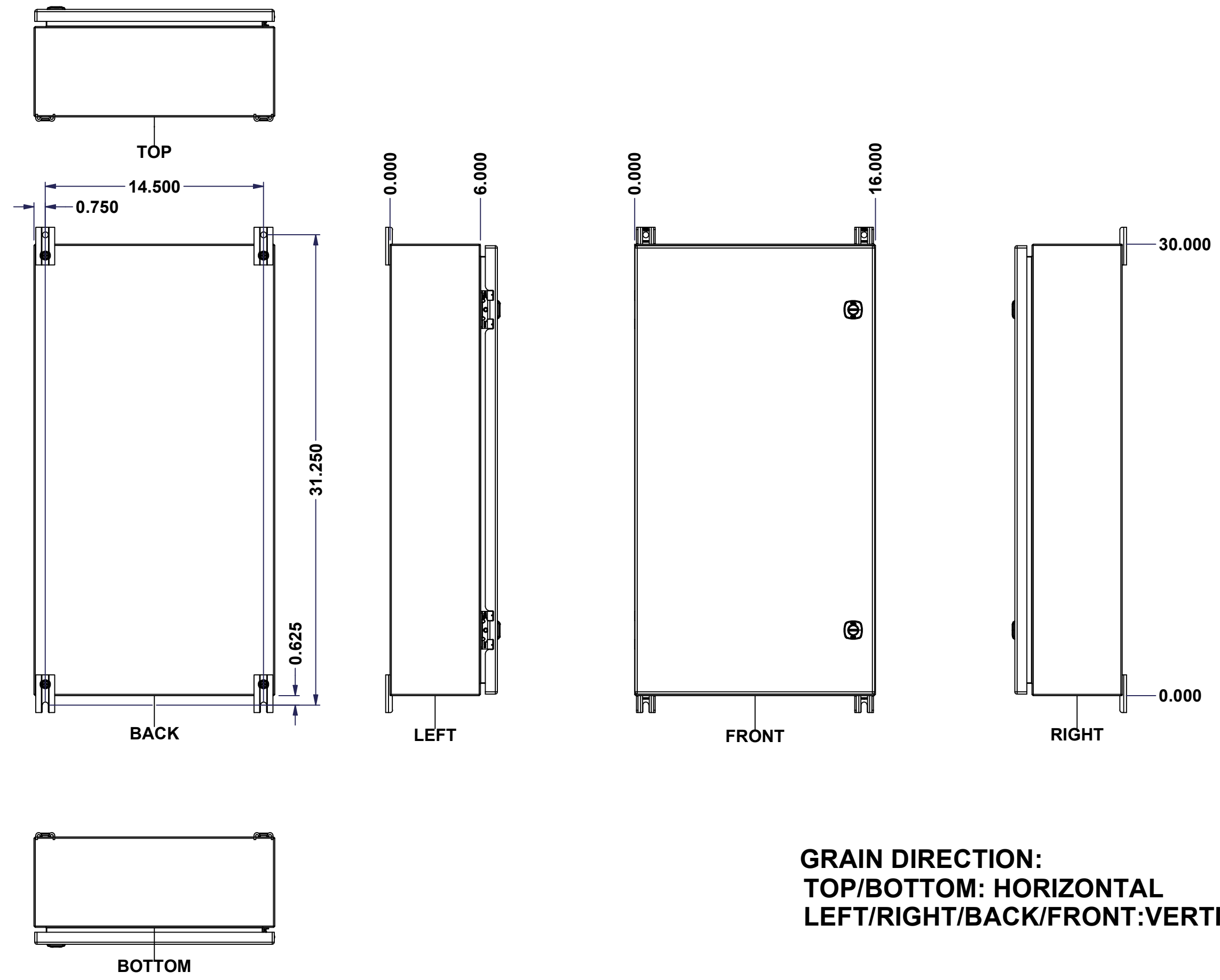

No.	Revisions	Date	By/Par

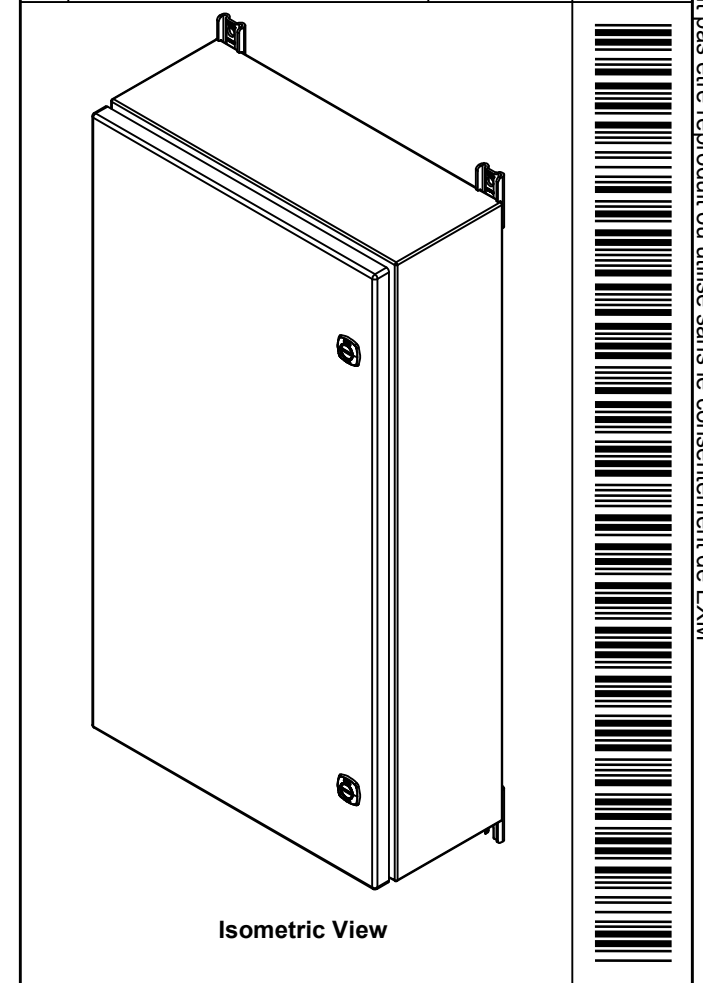

Tél: (450) 979-4373 Fax: (450) 979-4626 www.exmweb.com		Flatness Aplatissement Max 3.0mm Projection
Customer Client	Date	
Drawn By Dessiné Par	BoxCad: BoxCad	Date 30-May-23
Material Matière	16 Ga Stainless Steel 316 (1.4mm)	
Color Couleur	Unpainted	Finish Fini Brushed
Description	Detail Rev.	
5412ESS 30" x 16" x 6" Assembly		
Part Number Numéro Pièce	Rev.	1
5412ESS3016066TH	0	16

**GRAIN DIRECTION:
 TOP/BOTTOM: HORIZONTAL
 LEFT/RIGHT/BACK/FRONT: VERTICAL**

SEE BILL OF MATERIAL ON LAST PAGE

This drawing is confidential and must not be reproduced or used without the consent of EXM

Ce dessin est confidentiel et ne doit pas être reproduit ou utilisé sans le consentement de EXM

NOTE	
ITEM	DESCRIPTION
1	NEMA 4X Enclosure
2	C/W Standard ground studs on box and cover
3	C/W Standard door stiffener
4	C/W Standard inner panel (Included)
5	C/W Standard inner panel mounting studs
6	C/W 885 ESMF4_CLOSE Sold separately (Installed)
7	C/W 885 ESMF4_OPEN Sold separately (Installed)
8	C/W R5 Insulation (Installed by EXM)

No.	Revisions	Date	By/Par

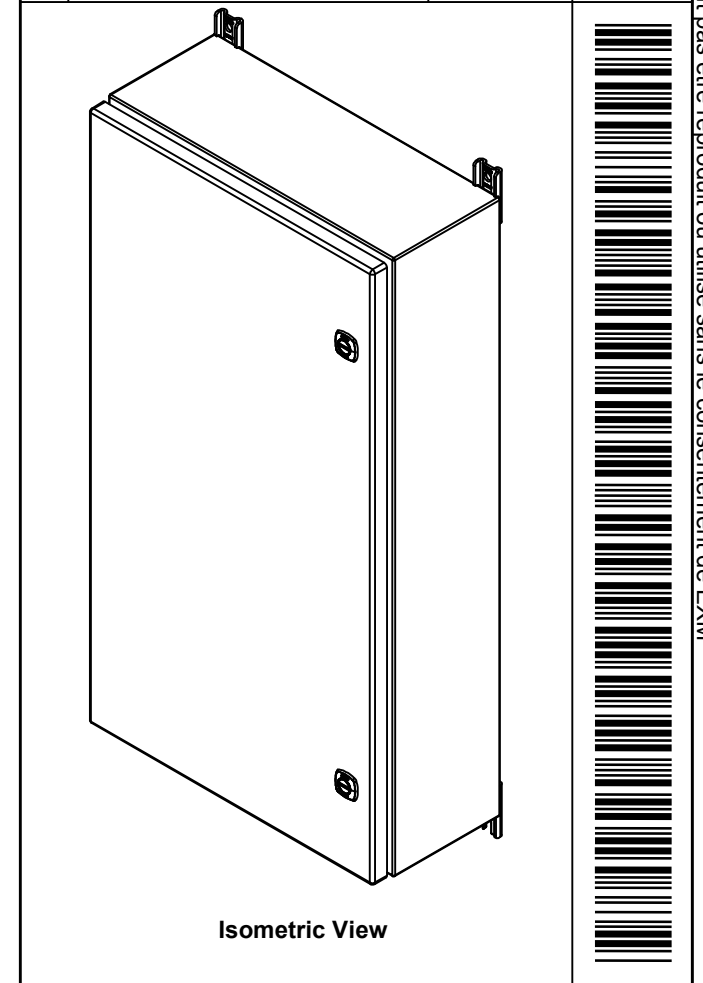



Tél: (450) 979-4373
Fax: (450) 979-4626
www.exmweb.com

Flatness
Aplatissement
Max 3.0mm
Projection



Customer Client	Date
Drawn By / Dessiné Par: BoxCad: BoxCad	Date: 30-May-23
Material / Matière: 16 Ga Stainless Steel 316 (1.4mm)	

Color / Couleur: Unpainted	Finish / Fini: Brushed
Description: 5412ESS 30" x 16" x 6" Assembly	Detail Rev.
Part Number / Numéro Pièce: 5412ESS3016066TH	Rev. 0

PACKING		
ITEM	QTY	DESCRIPTION
Cardboard sleeve	2	Top and Bottom
Cardboard strip	2	Between back of enclosure and inner panel
Plastic bag	1	To protect cover surface and inside gasket
Plastic strap - Black	2	To Squeeze the 2 cardboard sleeve together
Packaging label	1	White label with product number

4	STK-Q-00600	2	M12 to M8 Adaptor
1	881 SP3016G	0	881 SP - Inner Panel
1	STK-K-01800	5	5412 ES Accessory Kit
1	5412ESS3016066THC	0	5412ESS 30" x 16" Cover
1	5412ESS3016066THB	0	5412ESS 30" x 16" x 6" Body
2	STK-Q-04051-08	1	M6 x 8mm Stainless Steel Hexagon Socket Head Machine Screw with Nyseal
Qty	Part Number	Rev	Description
Parts List			

This drawing is confidential and must not be reproduced or used without the consent of EXM

Ce dessin est confidentiel et ne doit pas être reproduit ou utilisé sans le consentement de EXM

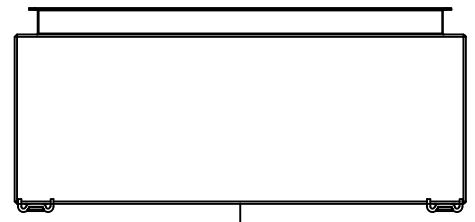

TOP

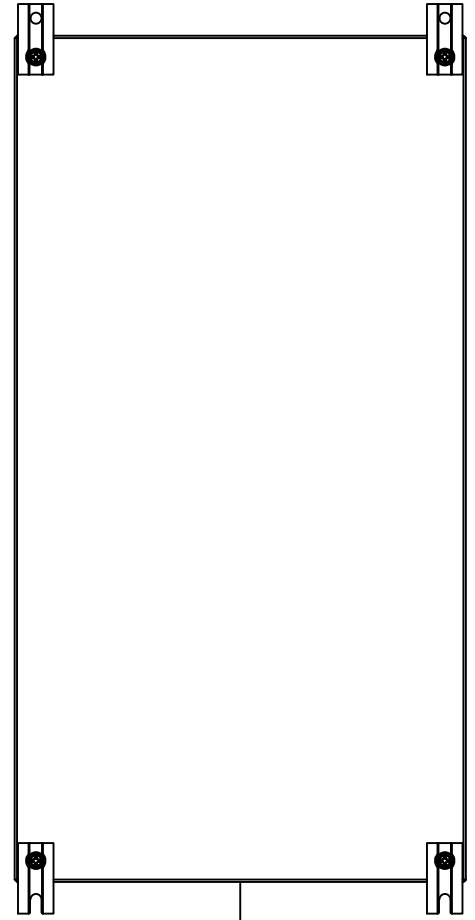

BACK

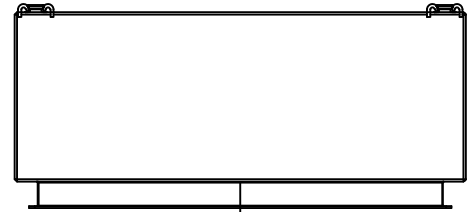

BOTTOM

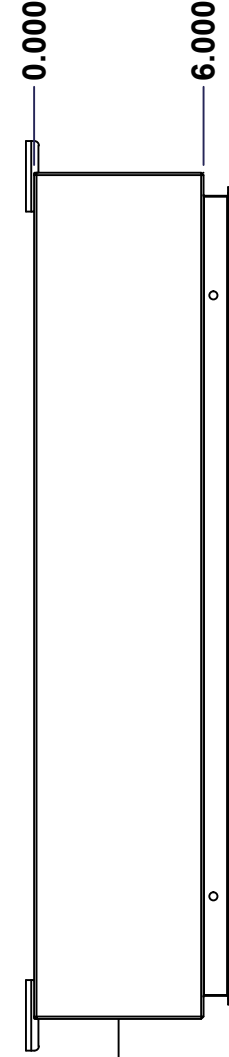

LEFT

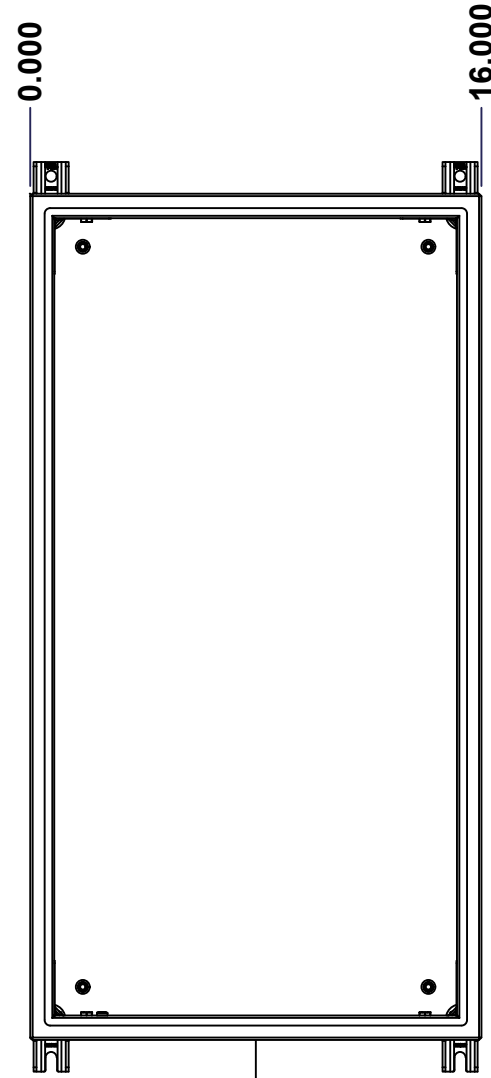

FRONT



RIGHT

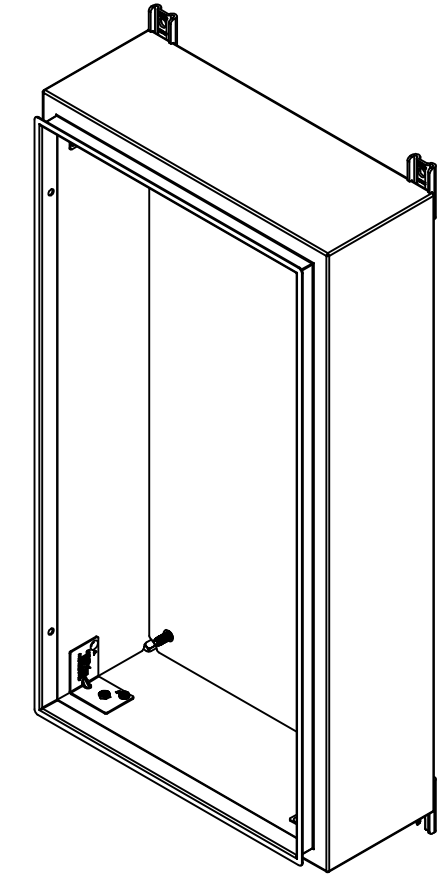

Isometric View

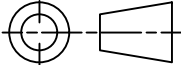

No.	Revisions	Date	By/Par

 Tél: (450) 979-4373 Fax: (450) 979-4626 www.exmweb.com		Flatness Aplatissement Max 3.0mm Projection 
Customer Client	Date	
Drawn By Dessiné Par	BoxCad: BoxCad	Date 30-May-23
Material Matière	16 Ga Stainless Steel 316 (1.4mm)	
Color Couleur	Unpainted	Finish Fini Brushed
Description	Detail Rev.	
5412ESS 30" x 16" x 6" Body		
Part Number Numéro Pièce	Rev.	3
5412ESS3016066THB	0	16

SEE BILL OF MATERIAL ON LAST PAGE

This drawing is confidential and must not be reproduced or used without the consent of EXM

Ce dessin est confidentiel et ne doit pas être reproduit ou utilisé sans le consentement de EXM

STANDARD FEATURES ARE NOT LISTED IN THIS HOLE TABLE			
HOLE TABLE - TOP VIEW (CUSTOM FEATURE ONLY)			
CUT-OUT	XDIM	YDIM	DESCRIPTION
1	2.000	4.500	INSUL. STUD M6 x 18mm (Inside)
2	14.000	4.500	INSUL. STUD M6 x 18mm (Inside)

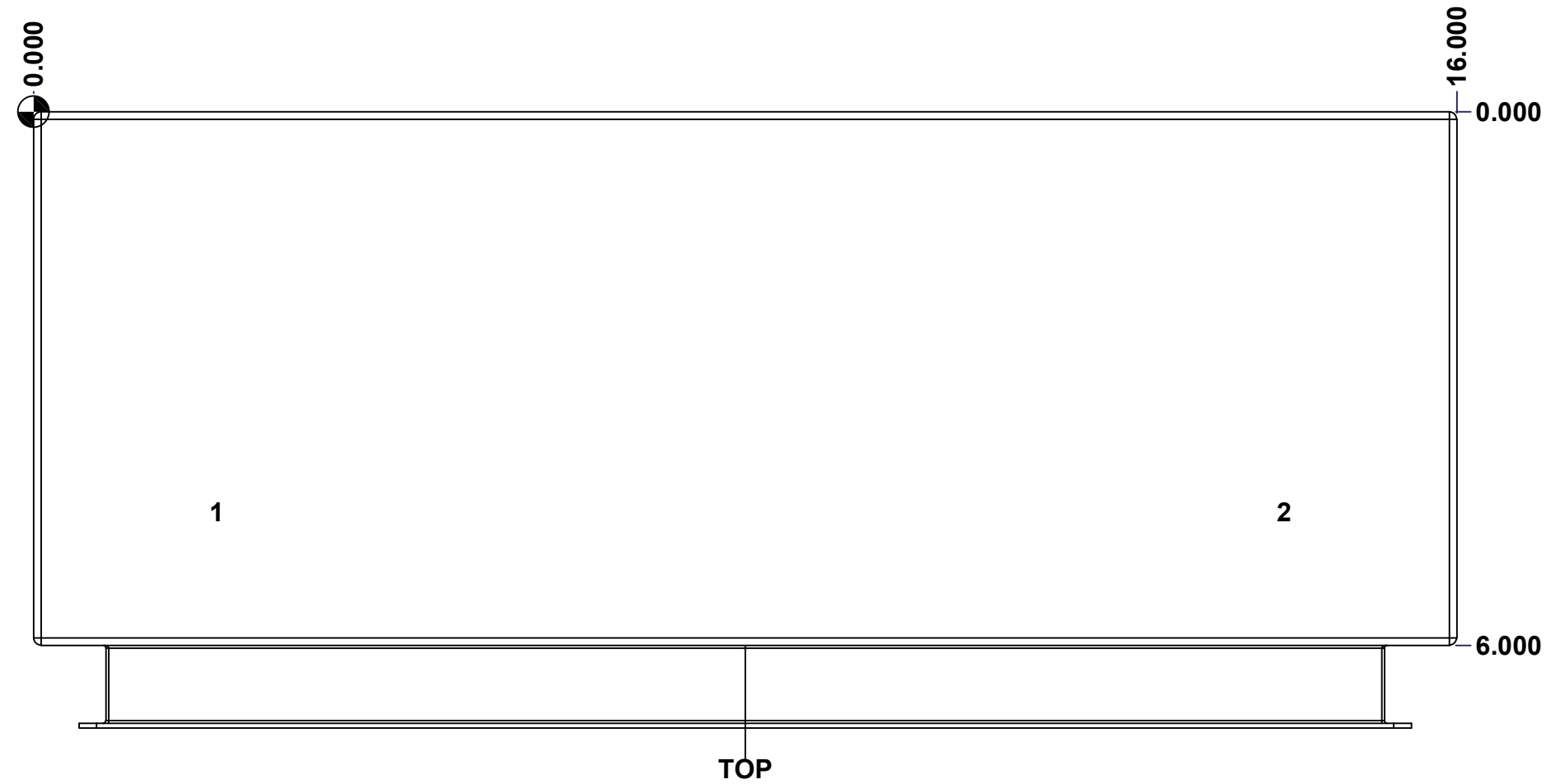

	Description	Status
	5412ESS 30" x 16" x 6" Body	(NULL)
	Part Number Numéro Pièce	Rev.
	5412ESS3016066THB	0 / 4
		16

This drawing is confidential and must not be reproduced or used without the consent of EXM

Ce dessin est confidentiel et ne doit pas être reproduit ou utilisé sans le consentement de EXM

STANDARD FEATURES ARE NOT LISTED IN THIS HOLE TABLE			
HOLE TABLE - BOTTOM VIEW (CUSTOM FEATURE ONLY)			
CUT-OUT	XDIM	YDIM	DESCRIPTION
1	2.000	4.500	INSUL. STUD M6 x 18mm (Inside)
2	14.000	4.500	INSUL. STUD M6 x 18mm (Inside)

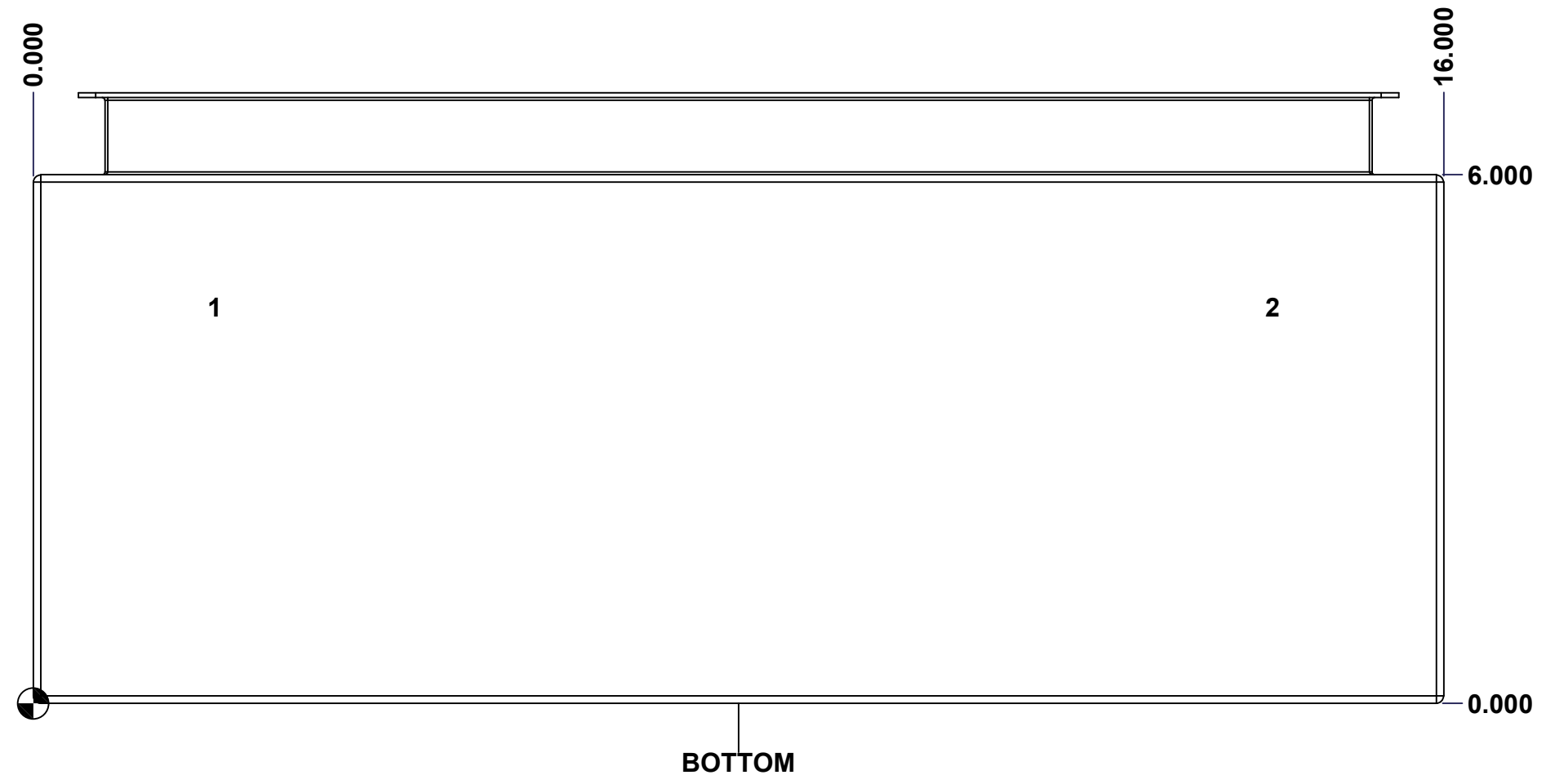

	Description	Status
	5412ESS 30" x 16" x 6" Body	(NULL)
	Part Number Numéro Pièce	Rev.
	5412ESS3016066THB	0 / 5
		16

This drawing is confidential and must not be reproduced or used without the consent of EXM

Ce dessin est confidentiel et ne doit pas être reproduit ou utilisé sans le consentement de EXM

STANDARD FEATURES ARE NOT LISTED IN THIS HOLE TABLE

HOLE TABLE - BACK VIEW (CUSTOM FEATURE ONLY)

CUT-OUT	XDIM	YDIM	DESCRIPTION
1	1.875	1.875	IP STUD M8 x 35mm (Inside)
2	1.875	28.125	IP STUD M8 x 35mm (Inside)
3	14.125	28.125	IP STUD M8 x 35mm (Inside)
4	14.125	1.875	IP STUD M8 x 35mm (Inside)

5	15.250	30.000	FOOT 885 ESMF4_CLOSE
6	0.750	30.000	FOOT 885 ESMF4_CLOSE
7	15.250	0.000	FOOT 885 ESMF4_OPEN
8	0.750	0.000	FOOT 885 ESMF4_OPEN

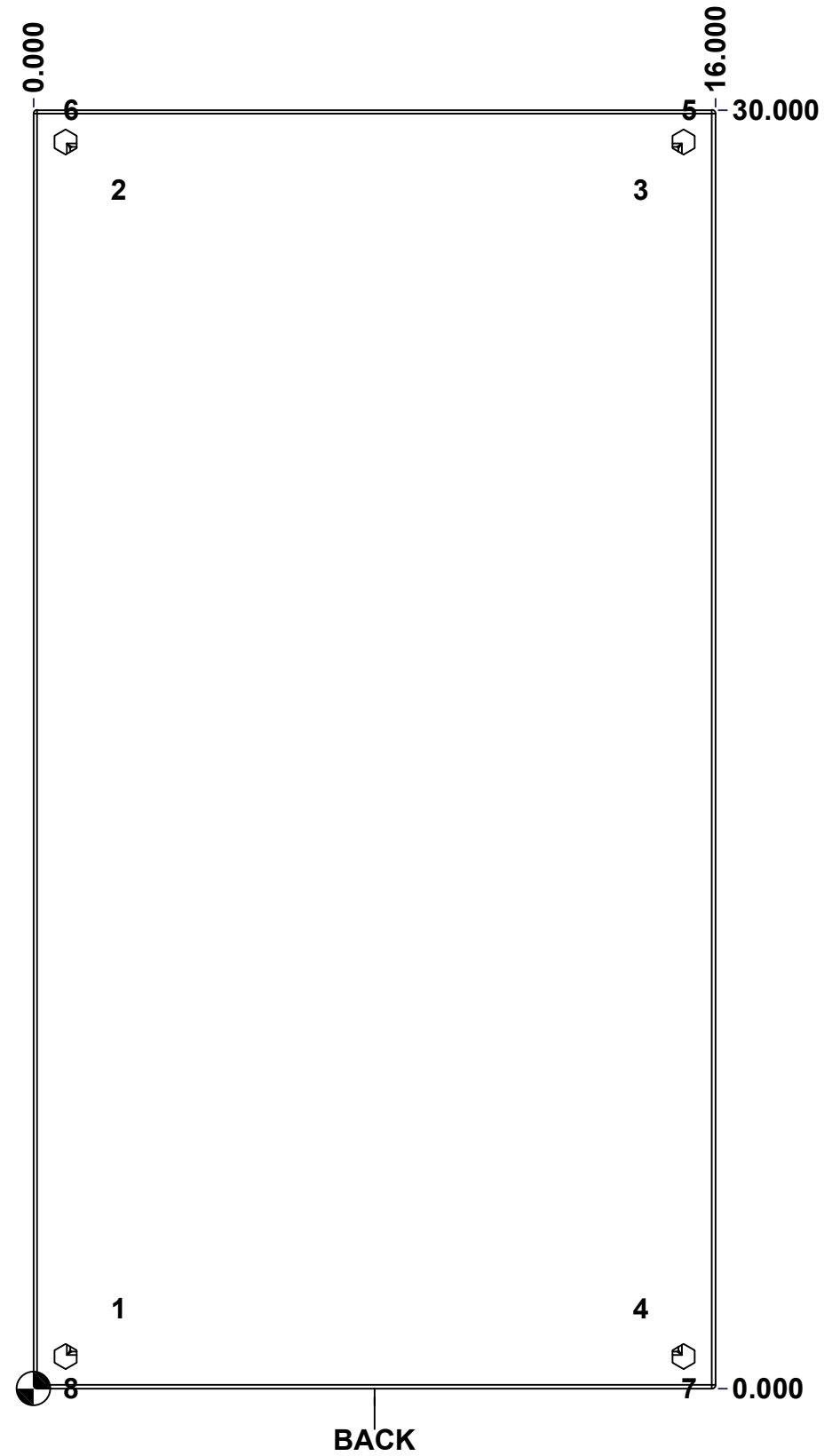

	Description	Status
	5412ESS 30" x 16" x 6" Body	(NULL)
	Part Number Numéro Pièce	Rev.
	5412ESS3016066THB	0 / 6
		16

This drawing is confidential and must not be reproduced or used without the consent of EXM

Ce dessin est confidentiel et ne doit pas être reproduit ou utilisé sans le consentement de EXM

No.	Revisions	Date	By/Par

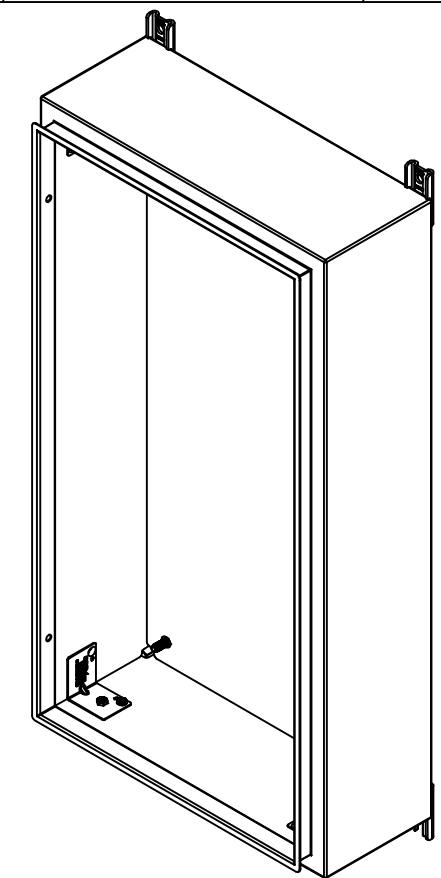

Isometric View

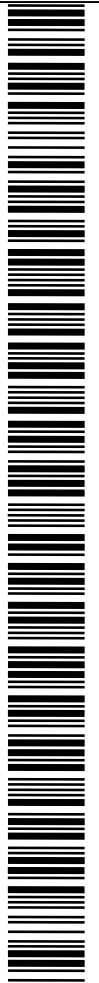

2	885ESMF4-FEET-A	0	885 ESMF4 Stainless Steel Mounting Foot (Opened Slot)
4	RIVET_NUT_SS_M10_FH_CE	0	Stainless Steel Rivet Nut M10 (Low Profile Close End)
4	STK-Q-06670	2	M10 x 16mm Stainless Steel Machine Screw
2	885ESMF4-FEET	0	885 ESMF4 Stainless Steel Mounting Foot
1	STK-K-70554	3	5412 ESTH Accessory Kit
1	5412ESS3016066THI-RS	0	5412ESS 30" x 16" Right Insulation
1	5412ESS3016066THI-LS	0	5412ESS 30" x 16" Left Insulation
1	5412ESS3016066THI-BT	0	5412ESS 30" x 16" Top and Bottom Insulation
1	5412ESS3016066THI-TP	0	5412ESS 30" x 16" Top and Bottom Insulation
1	5412ESS3016066THI-B	0	5412ESS 30" x 16" Back Insulation
4	STK-Q-16070	1	Stud M6 x 18mm Stainless steel
4	STK-Q-16020	1	Stud M8 x 35mm Stainless Steel
1	5412ESS3016066THB-P	0	5412ESS 30" x 16" x 6" Body Part

Qty	Part Number	Rev	Description
Parts List			



Tél: (450) 979-4373
Fax: (450) 979-4626
www.exmweb.com

Flatness
Aplatissement
Max 3.0mm

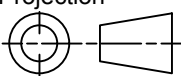
Projection

Customer Client		Date
Drawn By / Dessiné Par: BoxCad: BoxCad		Date: 30-May-23
Material / Matière: 16 Ga Stainless Steel 316 (1.4mm)		
Color / Couleur: Unpainted	Finish / Fini: Brushed	
Description: 5412ESS 30" x 16" x 6" Body		Detail Rev.
Part Number / Numéro Pièce: 5412ESS3016066THB		Rev. 0 / 7 / 16

This drawing is confidential and must not be reproduced or used without the consent of EXM

Ce dessin est confidentiel et ne doit pas être reproduit ou utilisé sans le consentement de EXM

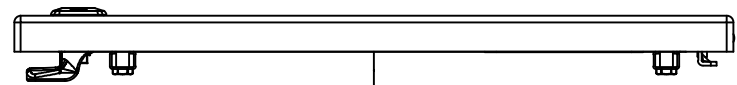

TOP

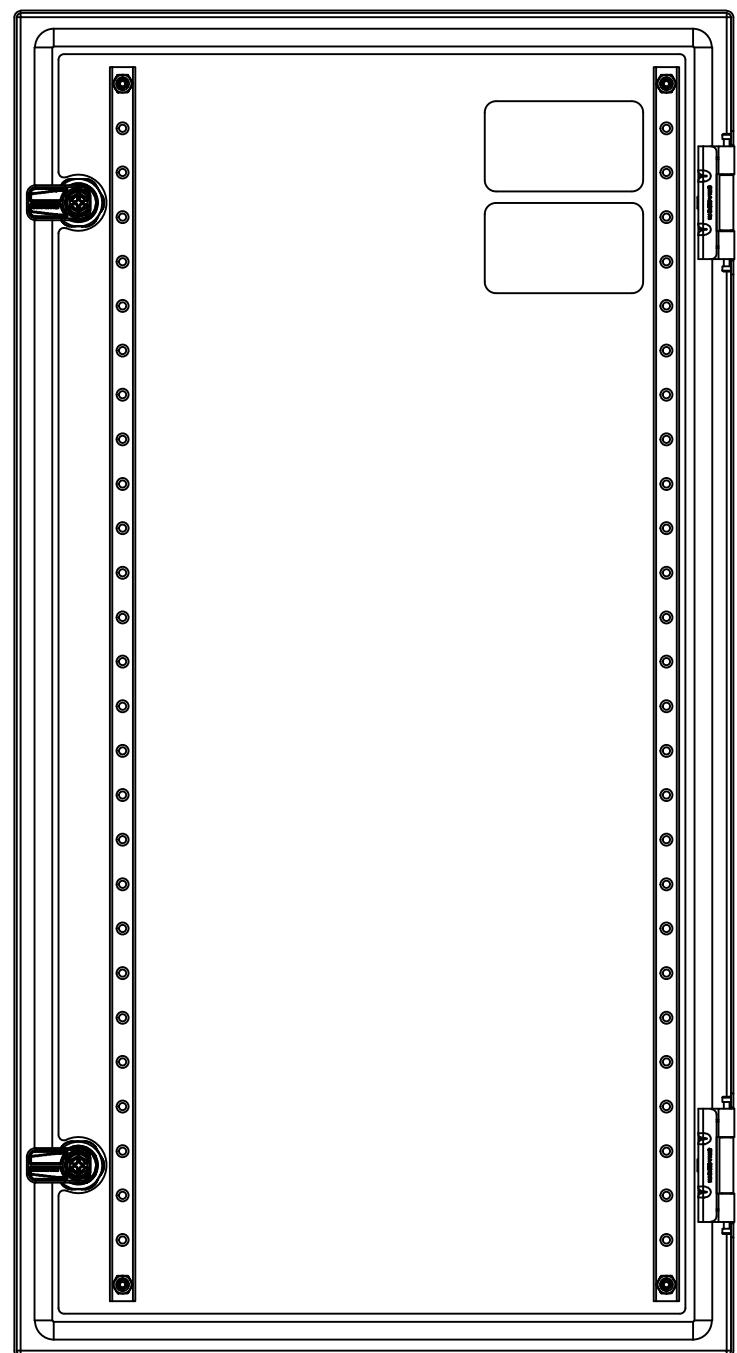

BACK

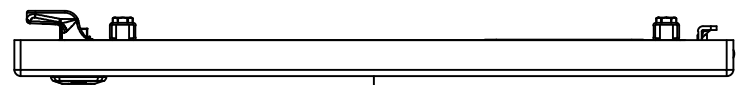

BOTTOM

0.000
0.800

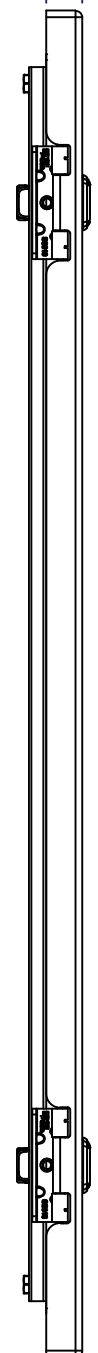

LEFT

0.000

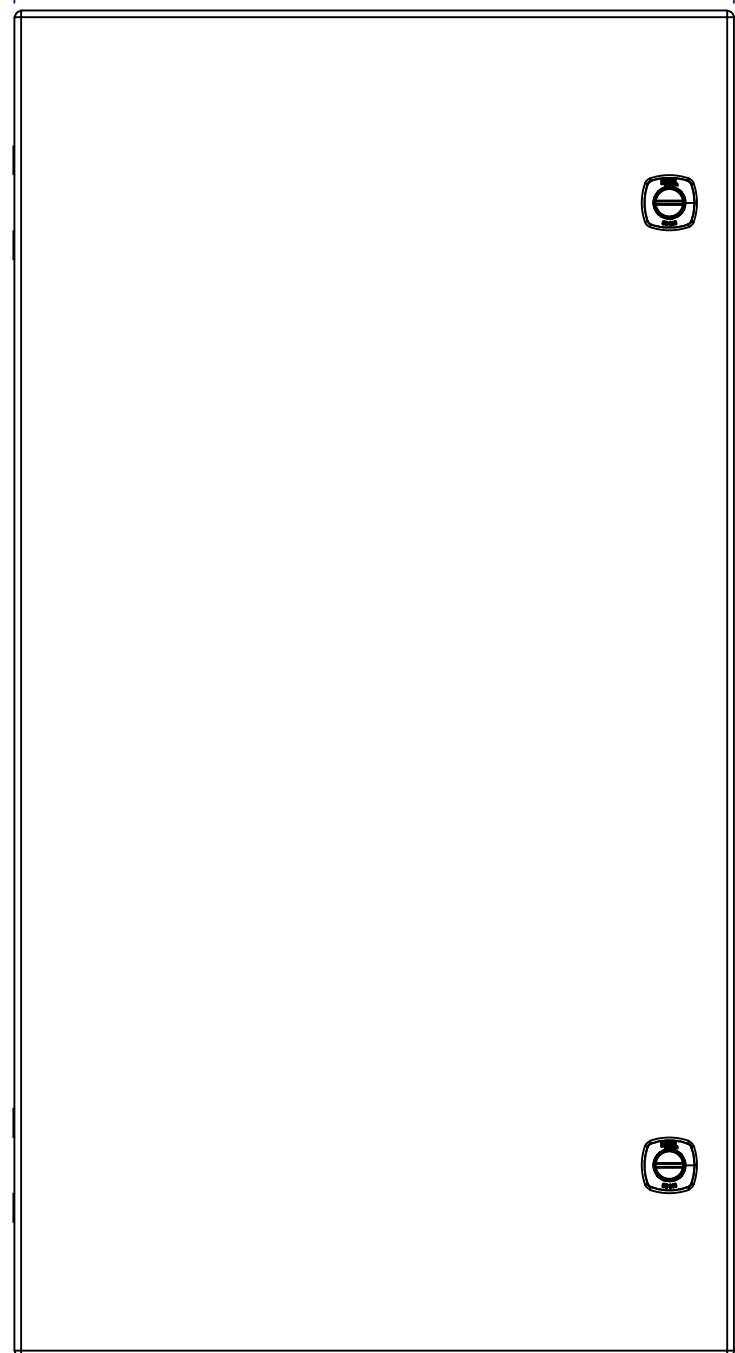

FRONT

15.918

29.803

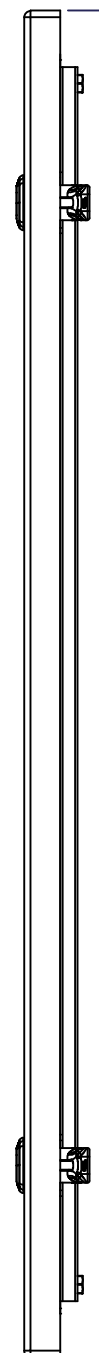

RIGHT

0.000

No.	Revisions	Date	By/Par

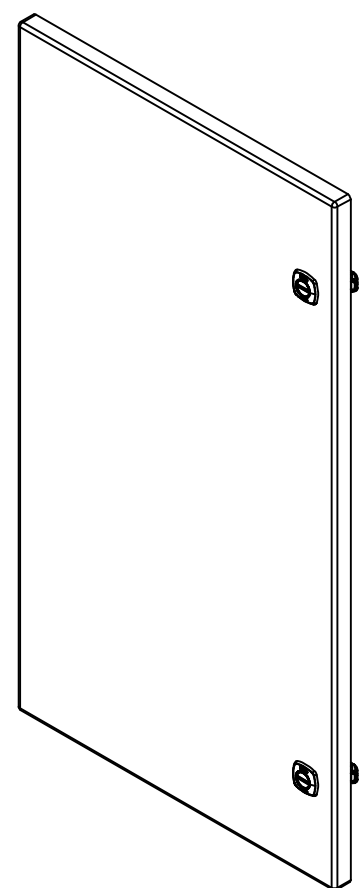

Isometric View



Tél: (450) 979-4373
Fax: (450) 979-4626
www.exmweb.com

Flatness
Aplatissement
Max 3.0mm
Projection

Customer Client	Date
Drawn By Dessiné Par BoxCad: BoxCad	Date 30-May-23
Material Matière 16 Ga Stainless Steel 316 (1.4mm)	

Color Couleur Unpainted	Finish Fini Brushed
----------------------------	------------------------

Description 5412ESS 30" x 16" Cover	Detail Rev.
--	-------------

Part Number Numéro Pièce 5412ESS3016066THC	Rev. 0	8	16
---	--------	---	----

SEE BILL OF MATERIAL ON LAST PAGE

This drawing is confidential and must not be reproduced or used without the consent of EXM

Ce dessin est confidentiel et ne doit pas être reproduit ou utilisé sans le consentement de EXM

STANDARD FEATURES ARE NOT LISTED IN THIS HOLE TABLE			
HOLE TABLE - FRONT VIEW (CUSTOM FEATURE ONLY)			
CUT-OUT	XDIM	YDIM	DESCRIPTION
1	1.486	1.614	STUD M6 x 18mm (Inside)
2	1.486	28.189	STUD M6 x 18mm (Inside)
3	13.517	28.189	STUD M6 x 18mm (Inside)
4	13.517	1.614	STUD M6 x 18mm (Inside)

5	14.494	25.553	880 SCQ4-SLSS6
6	14.494	4.250	880 SCQ4-SLSS6

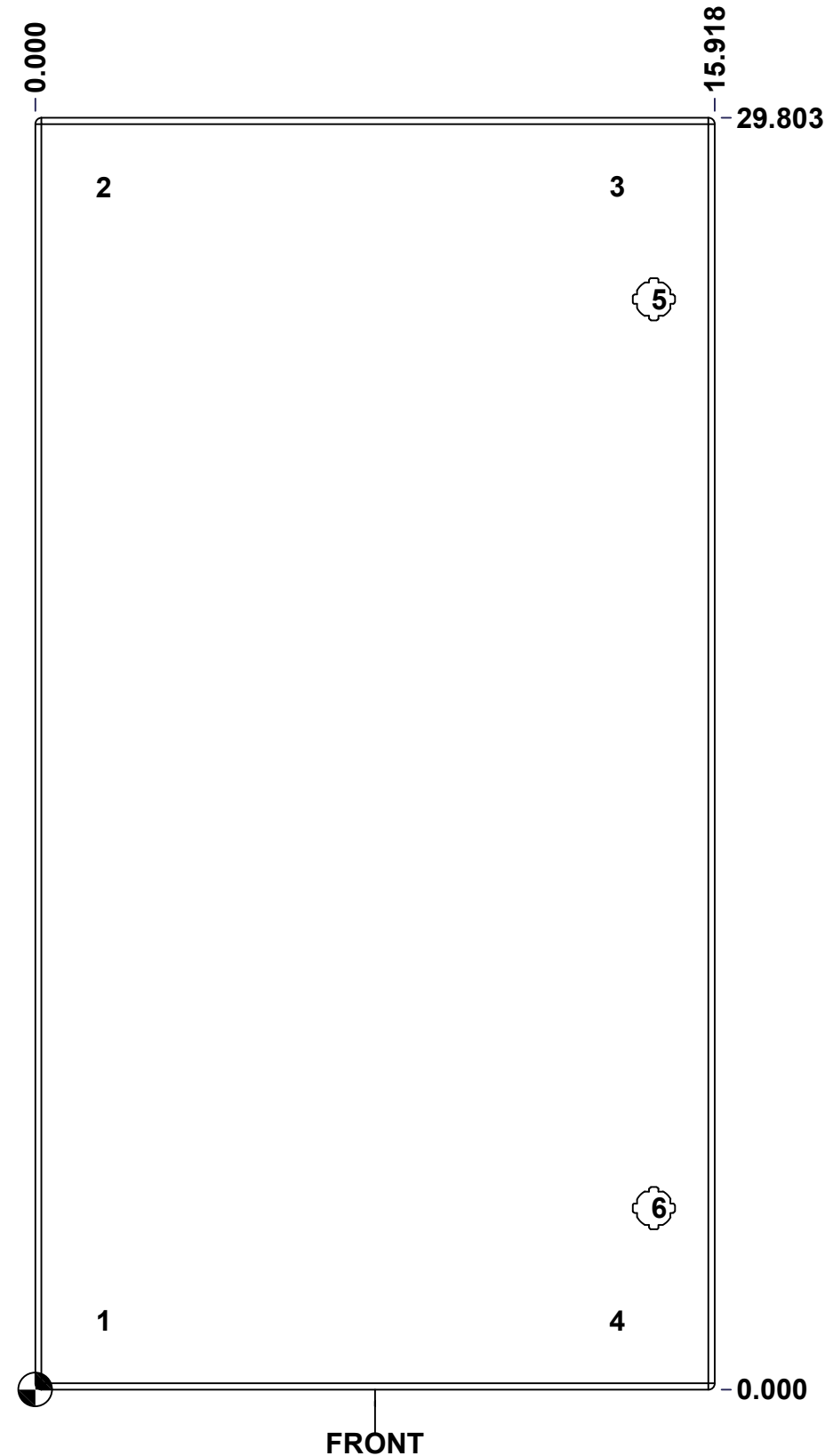

	Description	Status
	5412ESS 30" x 16" Cover	(NULL)
	Part Number Numéro Pièce	Rev.
	5412ESS3016066THC	0
		9
		16

This drawing is confidential and must not be reproduced or used without the consent of EXM

Ce dessin est confidentiel et ne doit pas être reproduit ou utilisé sans le consentement de EXM

No.	Revisions	Date	By/Par

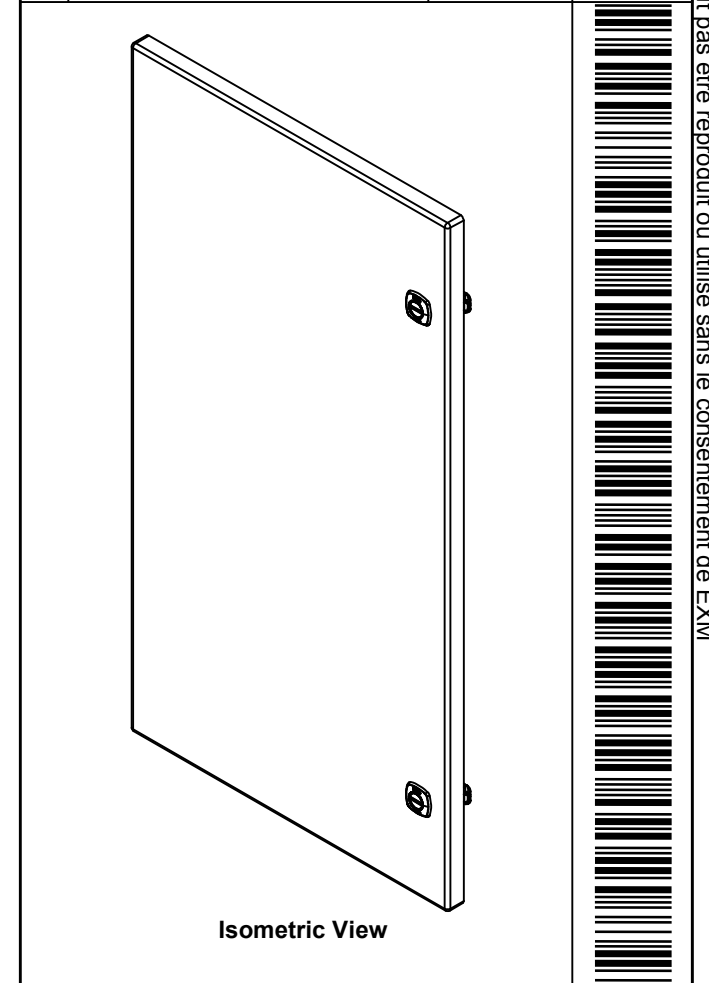

EXM
exm

Tél: (450) 979-4373
Fax: (450) 979-4626
www.exmweb.com

Flatness
Aplatissement
Max 3.0mm

Projection

Customer Client	Date
Drawn By Dessiné Par	Date 30-May-23

Material Matière	16 Ga Stainless Steel 316 (1.4mm)
---------------------	-----------------------------------

Color Couleur	Unpainted	Finish Fini	Brushed
------------------	-----------	----------------	---------

Description	Detail Rev.
5412ESS 30" x 16" Cover	

Part Number Numéro Pièce	Rev.	10
5412ESS3016066THC	0	16

QTY	Part Number	Rev	Description
2	STK-S-00100	0	3.5" x 2" Silver Milar Flexcon Sticker
4	STK-Q-07250	2	M6 x 16mm Collar Nut
2	STK-Q-46020-30	5	5412 ES Vertical Door Stiffener 30"
1	5412ESS3016066THI-C	0	5412ESS 30" x 16" Cover Insulation
4	STK-Q-16070	1	Stud M6 x 18mm Stainless steel
1	5412ESS3016066THG	0	5412ESS 30" x 16" Cover Gasket Part
1	5412ESS3016066THC-P	0	5412ESS 30" x 16" Cover Part
2	880 SCQ4-SLSS6	7	5412 ESS 1/4 Turn Lock
2	STK-A-33016	0	5412 ESS Bended Hinge (Body Part)
Parts List			

This drawing is confidential and must not be reproduced or used without the consent of EXM

Ce dessin est confidentiel et ne doit pas être reproduit ou utilisé sans le consentement de EXM

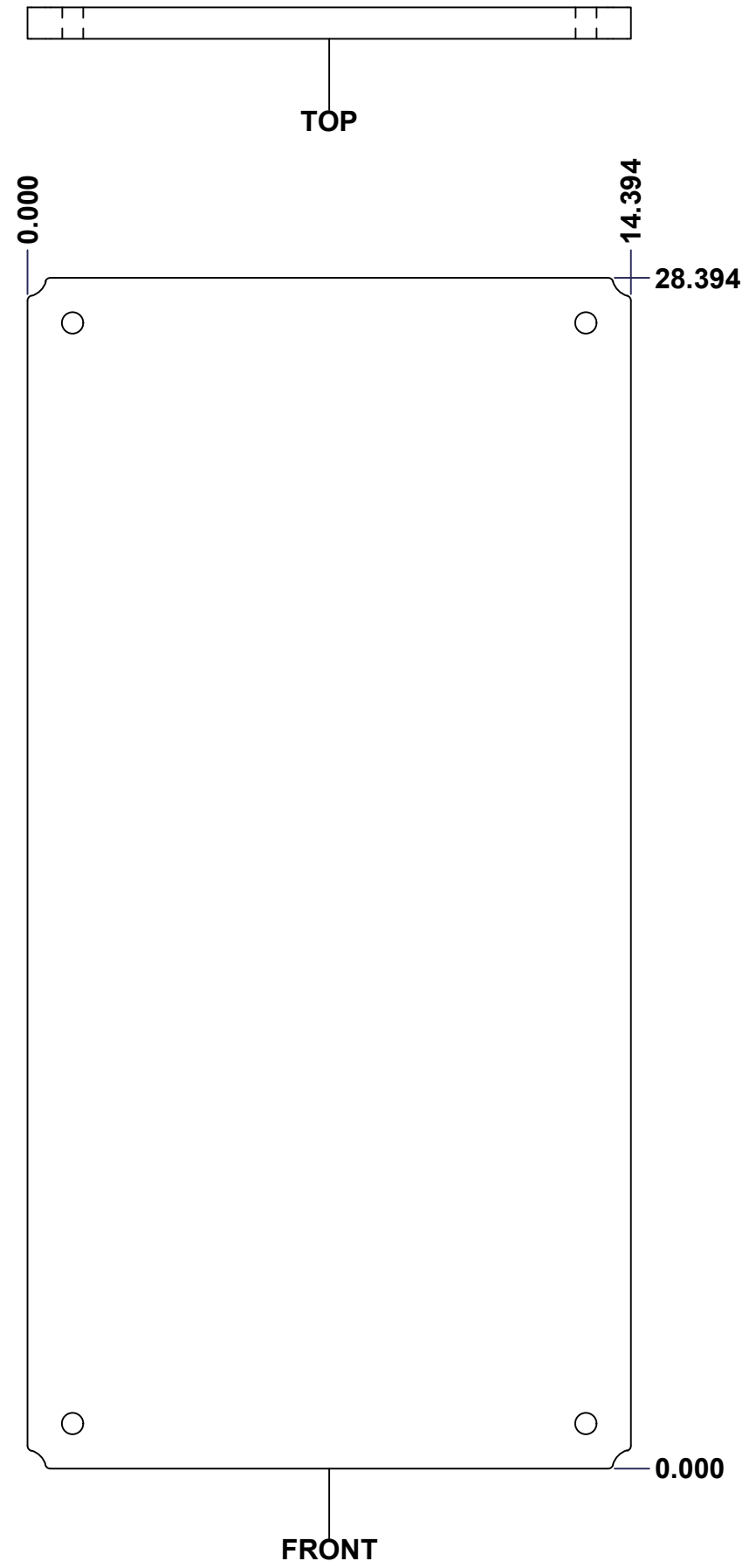

No.	Revisions	Date	By/Par

Isometric View

<p>Tél: (450) 979-4373 Fax: (450) 979-4626 www.exmweb.com</p>		Flatness Aplatissement	
		Max 3.0mm	
Customer Client		Date	
Drawn By Dessiné Par		Date	
Material Matière		Polyisocyanurate	
Color Couleur		Aluminum	Finish Fini
Description		Detail Rev.	
5412ESS 30" x 16" Back Insulation			
Part Number Numéro Pièce		Rev.	11
5412ESS3016066THI-B		0	16

SEE BILL OF MATERIAL ON LAST PAGE

This drawing is confidential and must not be reproduced or used without the consent of EXM

Ce dessin est confidentiel et ne doit pas être reproduit ou utilisé sans le consentement de EXM

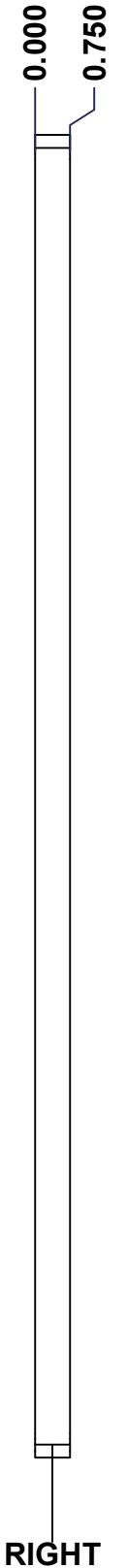
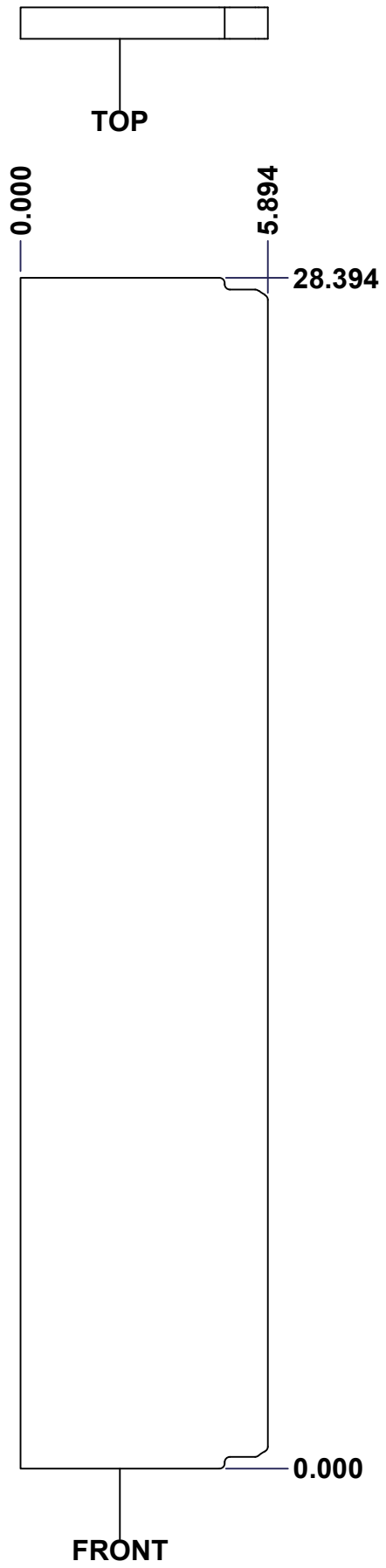

No.	Revisions	Date	By/Par

Isometric View

Tél: (450) 979-4373 Fax: (450) 979-4626 www.exmweb.com		Flatness Aplatissement Max 3.0mm
Projection 		Date 23-Jan-07
Customer Client	Date	
Drawn By Dessiné Par	BoxCad: Patrick Deschenes	Date 23-Jan-07
Material Matière	Polyisocyanurate	
Color Couleur	Aluminum	Finish Fini N/A
Description	Detail Rev.	
5412ESS 30" x 16" Left Insulation		
Part Number Numéro Pièce	Rev.	12
5412ESS3016066THI-LS	0	16

SEE BILL OF MATERIAL ON LAST PAGE

This drawing is confidential and must not be reproduced or used without the consent of EXM

Ce dessin est confidentiel et ne doit pas être reproduit ou utilisé sans le consentement de EXM

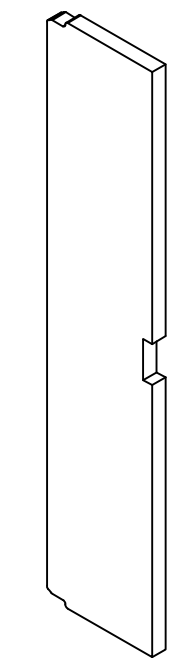
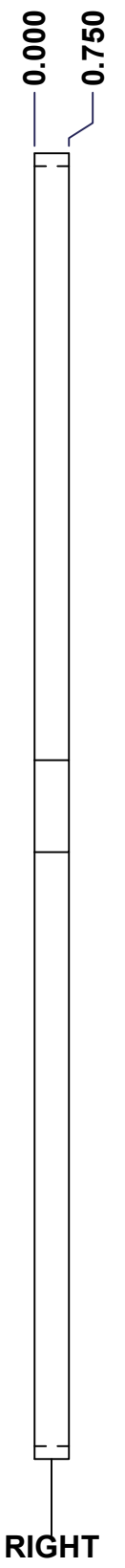
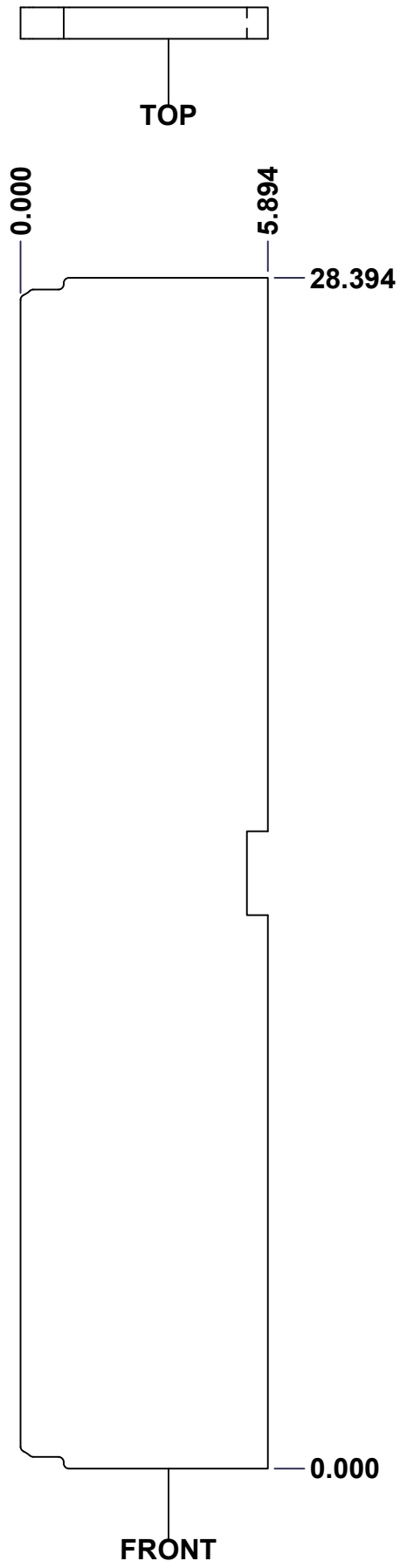

Isometric View

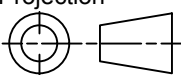

No.	Revisions	Date	By/Par

 Tél: (450) 979-4373 Fax: (450) 979-4626 www.exmweb.com		Flatness Aplatissement Max 3.0mm
Projection 		Date
Customer Client	BoxCad: Patrick Deschenes	Date 23-Jan-07
Material Matière	Polyisocyanurate	
Color Couleur	Aluminum	Finish Fini N/A
Description	5412ESS 30" x 16" Right Insulation	
Part Number Numéro Pièce	Rev. 0	13 / 16

SEE BILL OF MATERIAL ON LAST PAGE

5412ESS3016066THI-RS

This drawing is confidential and must not be reproduced or used without the consent of EXM

Ce dessin est confidentiel et ne doit pas être reproduit ou utilisé sans le consentement de EXM

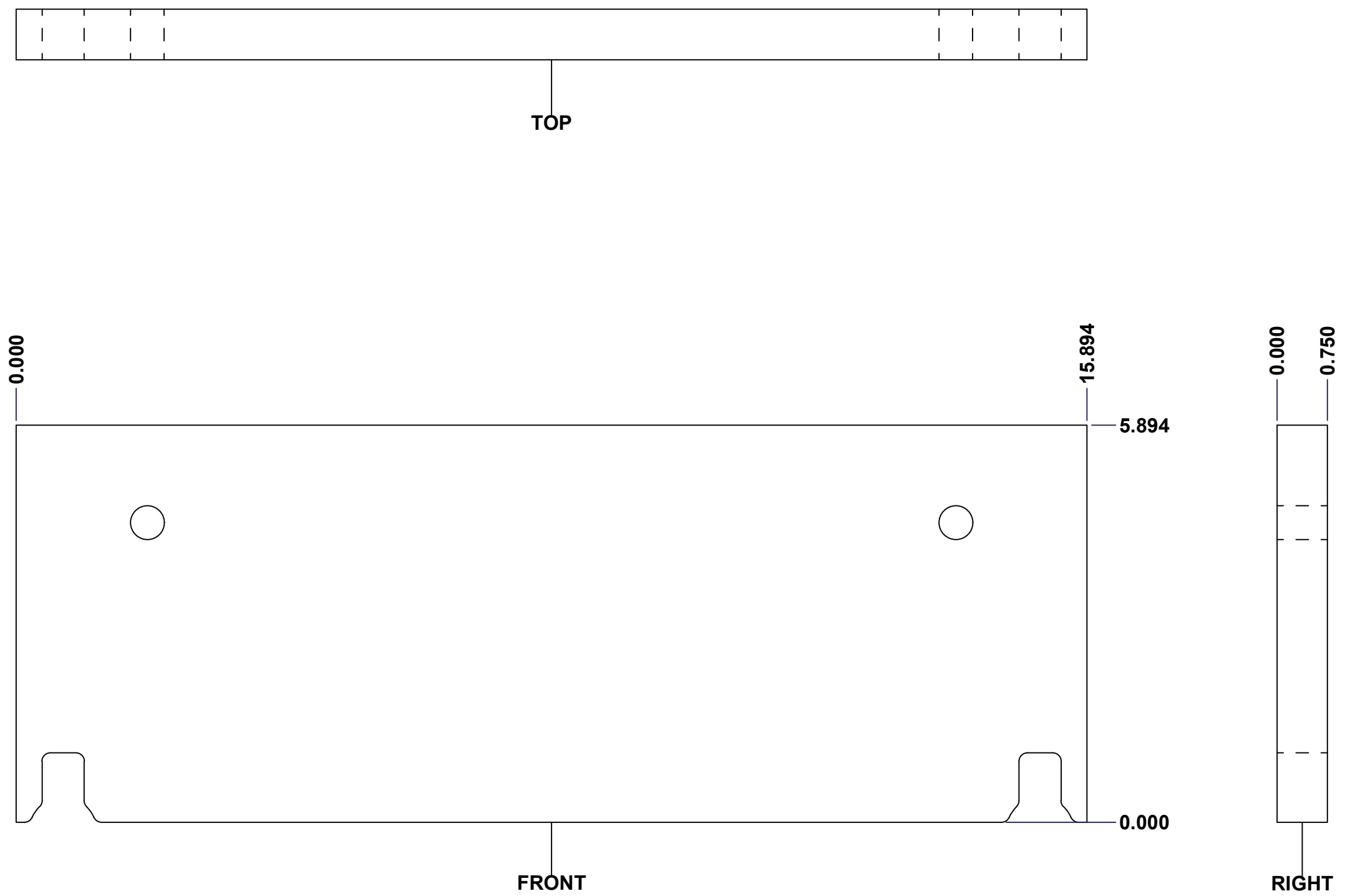

No.	Revisions	Date	By/Par

Isometric View

Tél: (450) 979-4373 Fax: (450) 979-4626 www.exmweb.com		Flatness Aplatissement Max 3.0mm Projection
Customer Client	Date	
Drawn By Dessiné Par	BoxCad: Patrick Deschenes	Date 23-Jan-07
Material Matière	Polyisocyanurate	
Color Couleur	Aluminum	Finish Fini N/A
Description	Detail Rev.	
5412ESS 30" x 16" Top and Bottom Insulation		
Part Number Numéro Pièce	Rev.	14
5412ESS3016066THI-TP	0	16

SEE BILL OF MATERIAL ON LAST PAGE

This drawing is confidential and must not be reproduced or used without the consent of EXM

Ce dessin est confidentiel et ne doit pas être reproduit ou utilisé sans le consentement de EXM

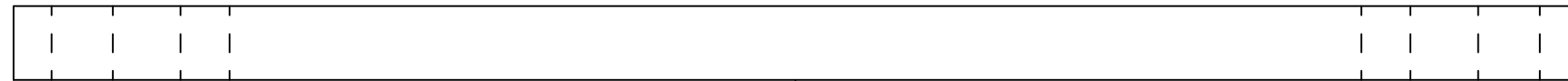

TOP

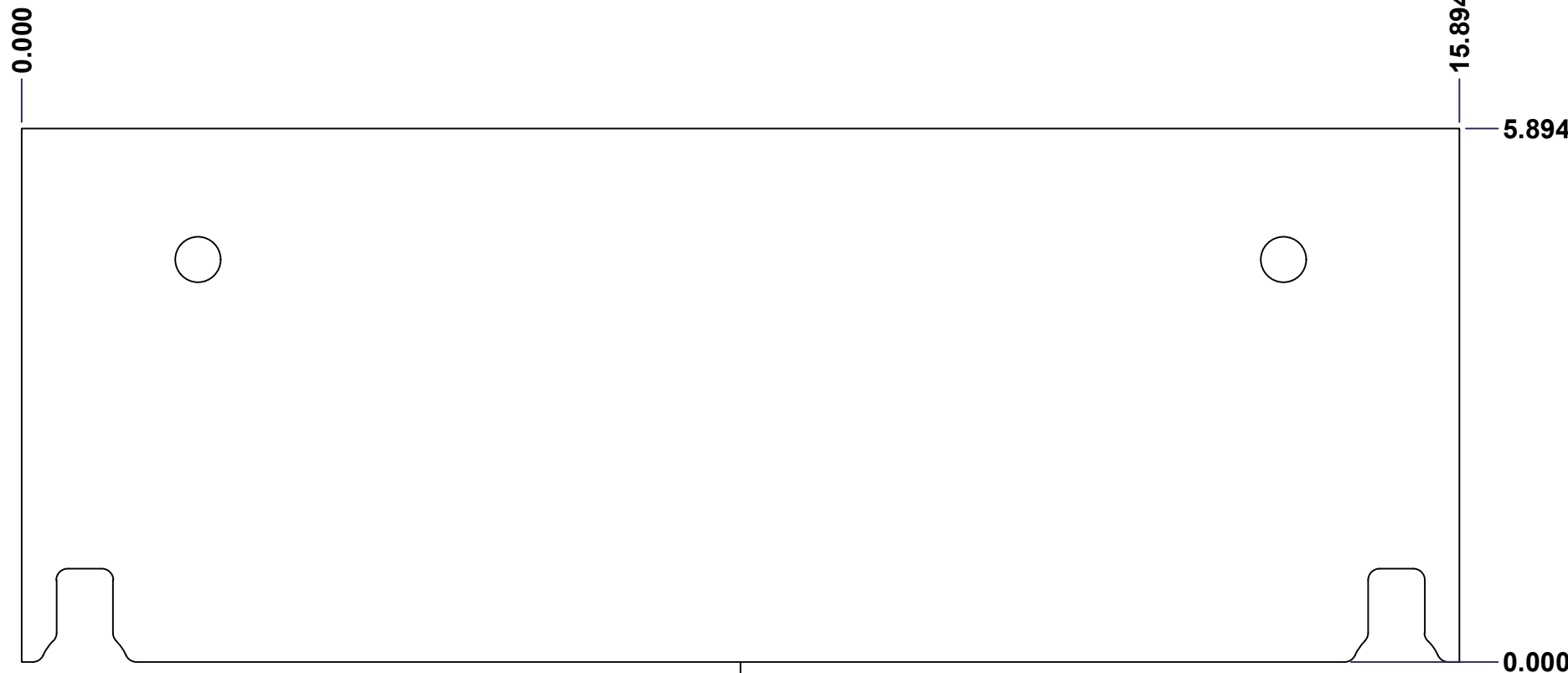

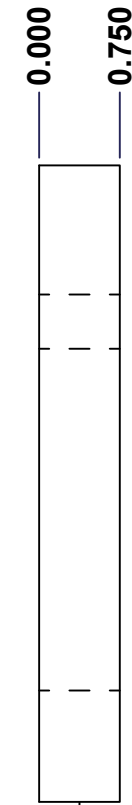

FRONT

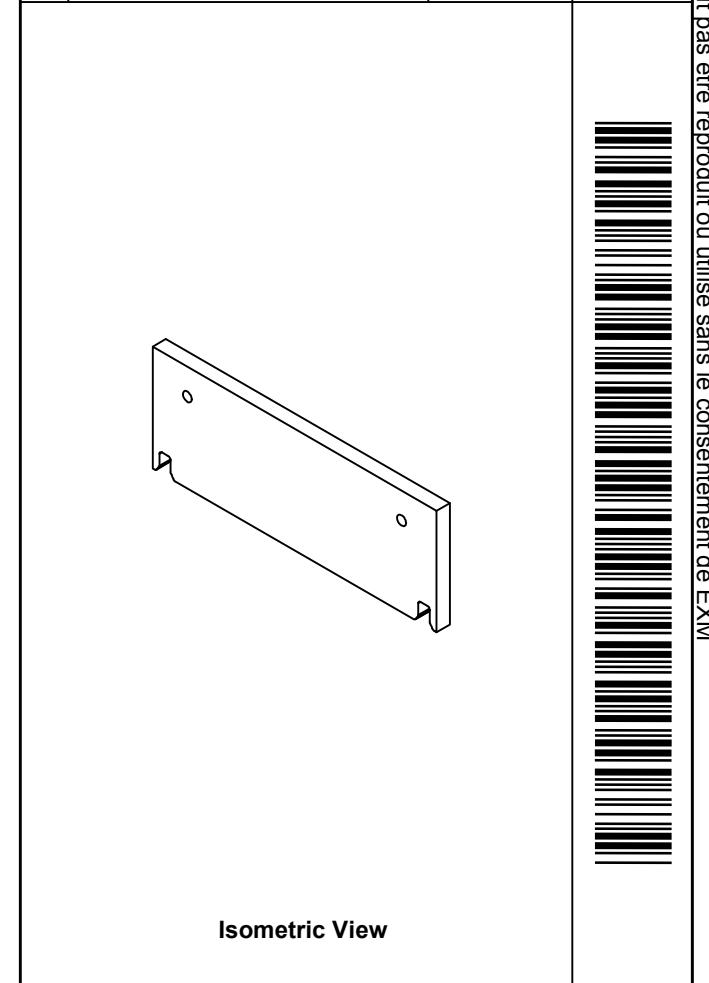

RIGHT

No.	Revisions	Date	By/Par

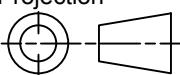

 Tél: (450) 979-4373 Fax: (450) 979-4626 www.exmweb.com		Flatness Aplatissement Max 3.0mm Projection 
Customer Client	Date	
Drawn By Dessiné Par	BoxCad: Patrick Deschenes	Date 23-Jan-07
Material Matière	Polyisocyanurate	
Color Couleur	Aluminum	Finish Fini N/A
Description	Detail Rev.	
5412ESS 30" x 16" Top and Bottom Insulation		
Part Number Numéro Pièce	Rev.	15
5412ESS3016066THI-BT	0	16

SEE BILL OF MATERIAL ON LAST PAGE

This drawing is confidential and must not be reproduced or used without the consent of EXM

Ce dessin est confidentiel et ne doit pas être reproduit ou utilisé sans le consentement de EXM

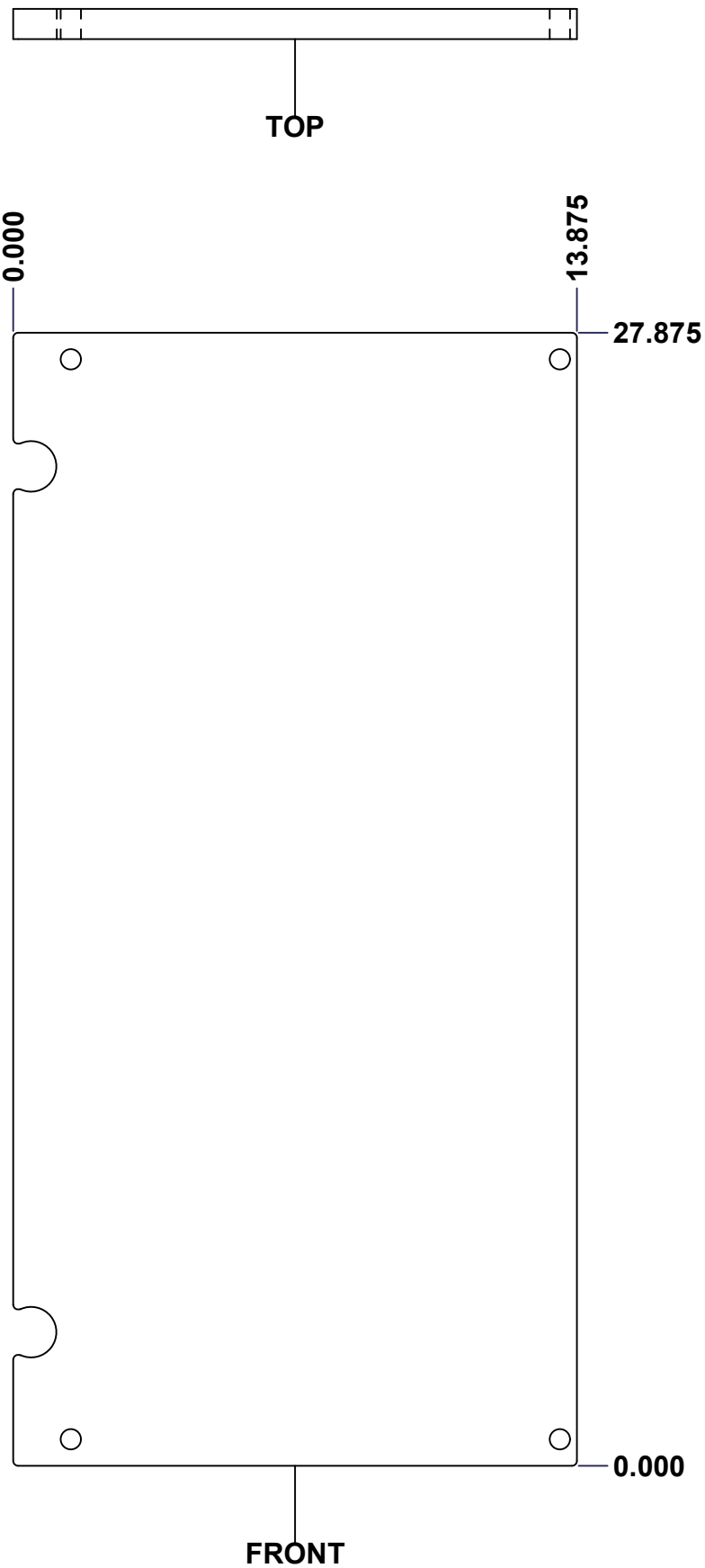

No.	Revisions	Date	By/Par

Isometric View

<p>Tél: (450) 979-4373 Fax: (450) 979-4626 www.exmweb.com</p>		Flatness Aplatissement
		Max 3.0mm
		Projection
Customer Client	Date	
Drawn By Dessiné Par	BoxCad: Patrick Deschenes	Date 23-Jan-07
Material Matière Polyisocyanurate		
Color Couleur	Aluminum	Finish Fini N/A
Description 5412ESS 30" x 16" Cover Insulation		Detail Rev.
Part Number Numéro Pièce	Rev. 0	16

SEE BILL OF MATERIAL ON LAST PAGE

5412ESS3016066THI-C

This drawing is confidential and must not be reproduced or used without the consent of EXM

Ce dessin est confidentiel et ne doit pas être reproduit ou utilisé sans le consentement de EXM

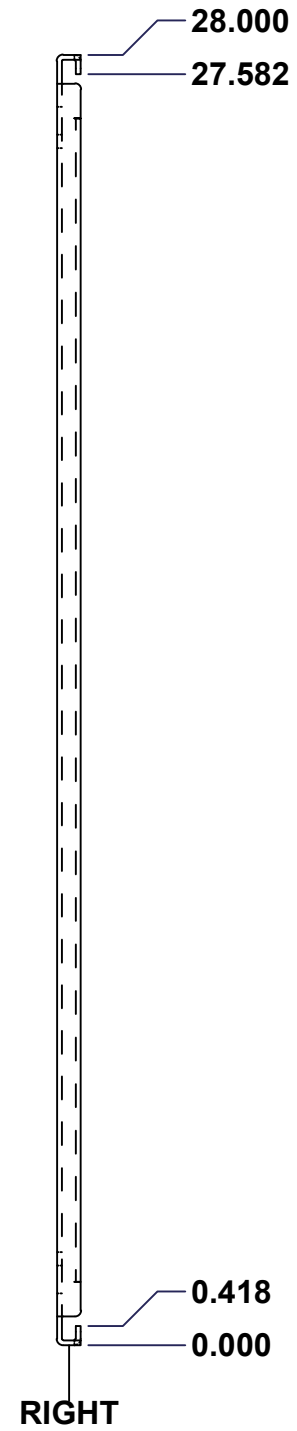
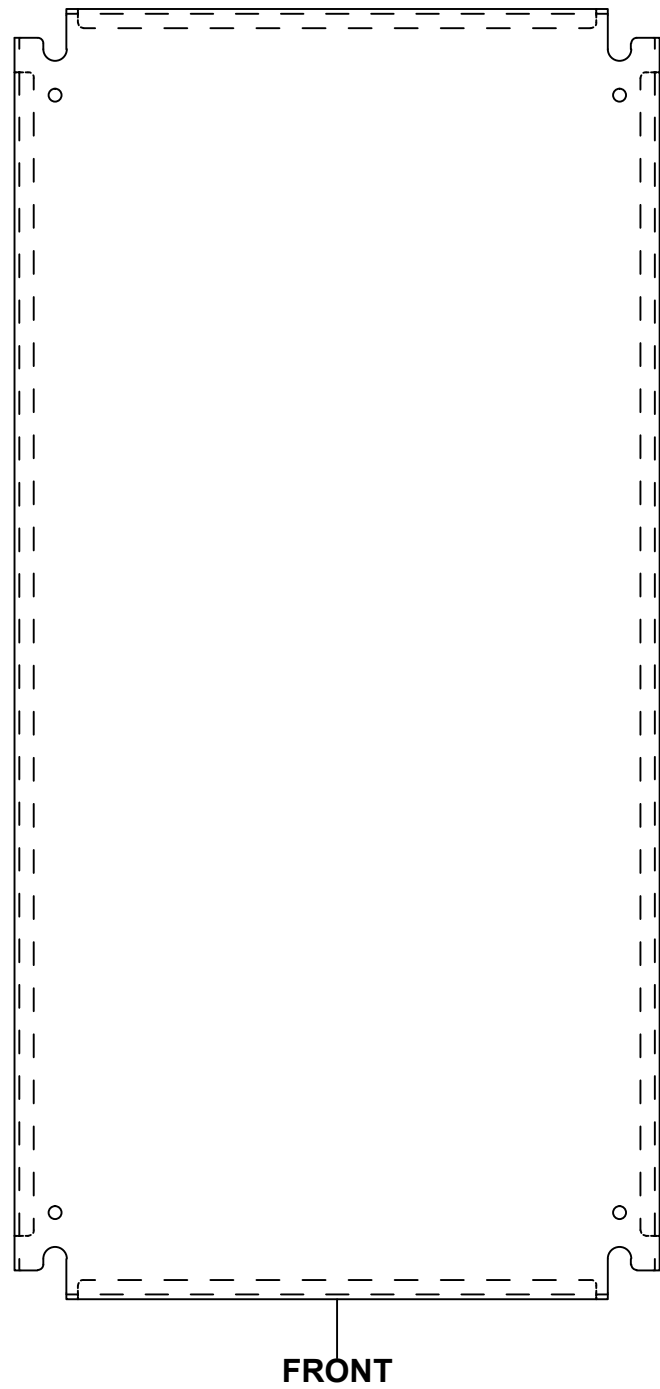
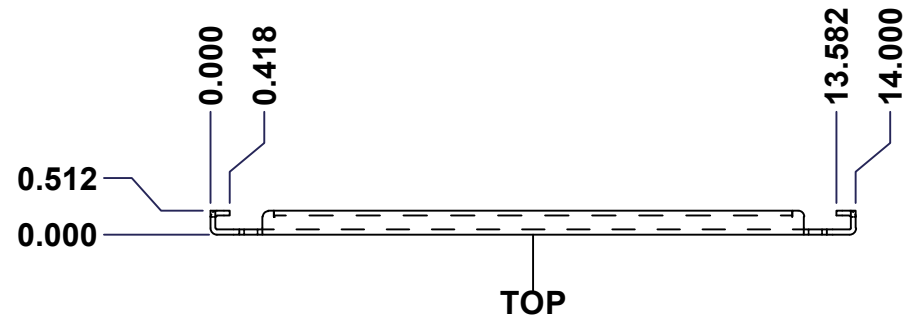

No.	Revisions	Date	By/Par

Isometric View

Tél: (450) 979-4373 Fax: (450) 979-4626 www.exmweb.com	Flatness Aplatissement	Max 3.0mm
	Projection	
Customer Client	Date	
Drawn By Dessiné Par	BoxCad	Date 23-Jan-07
Material Matière	See Part List	
Color Couleur	See Part List	Finish Fini See Part List
Description	Detail Rev.	
881 SP - Inner Panel		
Part Number Numéro Pièce	Rev. 0	1/2
881 SP3016G		

Qty	Part Number	Rev	Description	Material	Color	Finish
1	881 SP3016G-P	0	881 SP - Inner Panel Part	12 Ga Galvanized	Unpainted	Galvanized

Parts List

This drawing is confidential and must not be reproduced or used without the consent of EXM

Ce dessin est confidentiel et ne doit pas être reproduit ou utilisé sans le consentement de EXM

Table 1			FRONT VIEW
CUT-OUT	XDIM	YDIM	DESCRIPTION
1	0.875	1.875	GROUND HOLE (RND Ø0.290)
2	13.125	1.875	GROUND HOLE (RND Ø0.290)
3	0.875	26.125	GROUND HOLE (RND Ø0.290)
4	13.125	26.125	GROUND HOLE (RND Ø0.290)

All knockouts are actual size / Les disques défonçables sont grandeur réel

No.	Revisions	Date	By/Par

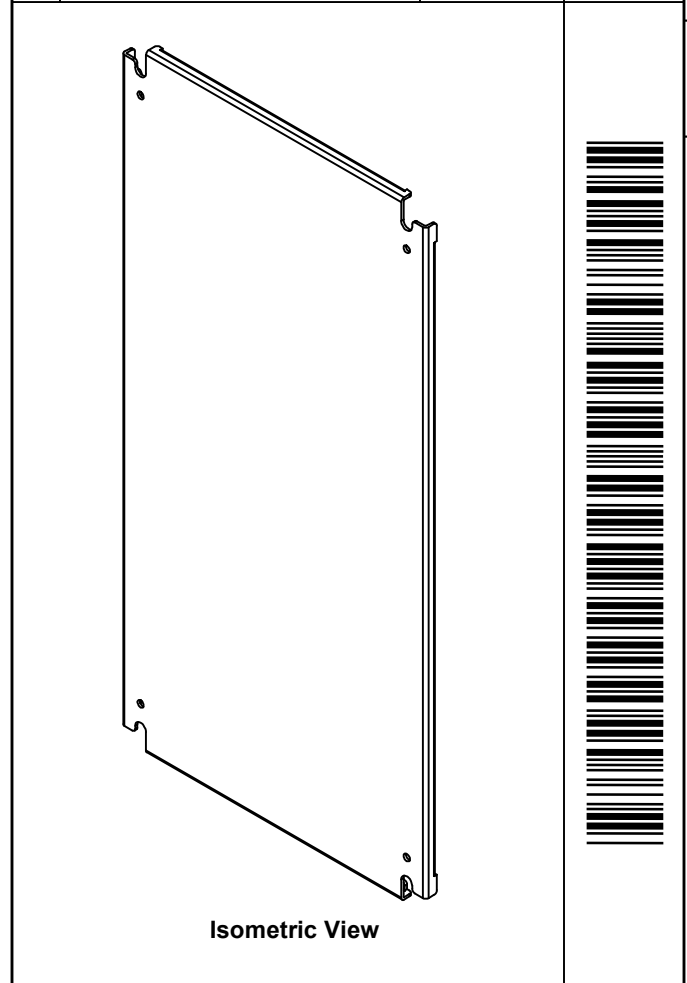
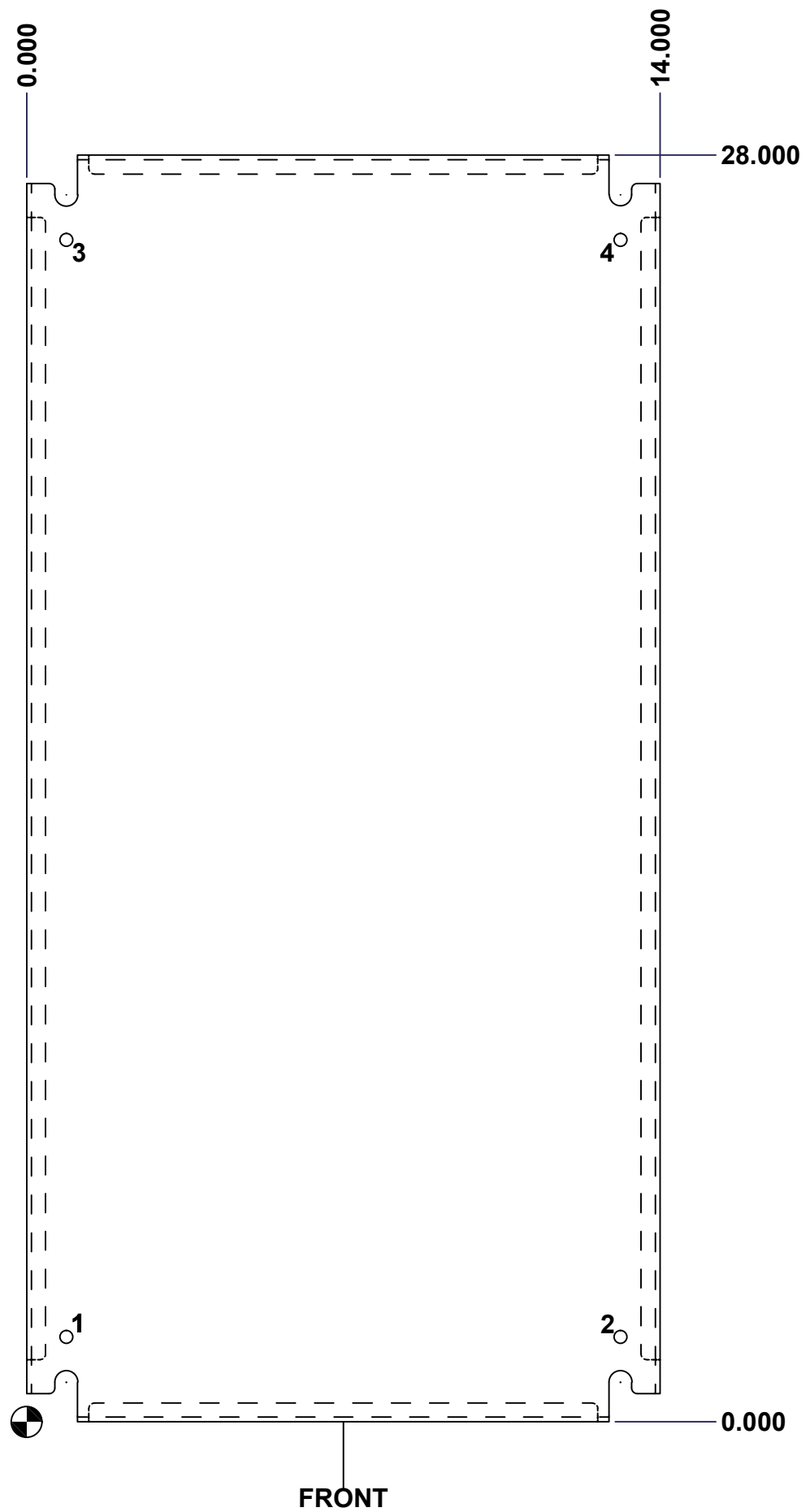

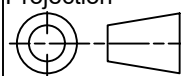
 Tél: (450) 979-4373 Fax: (450) 979-4626 www.exmweb.com		Flatness Aplatissement Max 3.0mm Projection 
Customer Client	Date	
Drawn By Dessiné Par	BoxCad	Date 23-Jan-07
Material Matière	See Part List	
Color Couleur	See Part List	Finish Fini See Part List
Description 881 SP - Inner Panel		Detail Rev.
Part Number Numéro Pièce	881 SP3016G	Rev. 2 0